



SGM4914

95mW, Capless, Stereo Headphone Amplifier with Shutdown

GENERAL DESCRIPTION

The SGM4914 stereo headphone amplifier is designed for portable equipment where board space is at a premium. The SGM4914 uses capless architecture to produce a ground-referenced output from a single power supply, eliminating the need for large DC-blocking capacitors for output, saving cost, board space, and component height. Additionally, for SGM4914B and SGM4914C, the gain is set internally (-2V/V or -1.5V/V), further reducing component count. For SGM4914A, the gain can be adjusted by external feedback resistors.

The SGM4914 delivers up to 95mW per channel into a 32Ω load and has low 0.01% THD+N. A -90dB power supply rejection ratio (PSRR) at 217Hz allows this device to operate from noisy digital supplies without an additional linear regulator. Comprehensive click-and-pop circuitry suppresses audible clicks and pops on startup and shutdown. Independent left/right, low-power shutdown controls make it possible to optimize power savings in mixed-mode, mono/stereo applications.

The SGM4914 operates from a single 2.7V to 5.5V supply, consumes only 5.6mA supply current, has short-circuit and thermal-overload protections, and is specified over the extended -40°C to +85°C temperature range. The SGM4914 is available in a Green TQFN-4x4-20L package.

FEATURES

- **SGM4914A: External Feedback Gain Network**
SGM4914B: Fixed -2V/V Gain
SGM4914C: Fixed -1.5V/V Gain
- **No Bulky DC-Blocking Capacitors Required**
- **Ground-Referenced Outputs Eliminate DC-Bias Voltage on Headphone Ground Pin**
- **No Degradation of Low-Frequency Response Due to Output Capacitors**
- **95mW into 32Ω Load from 5V Power Supply at THD+N = 0.1% (TYP, per Channel)**
- **Low 0.01% THD+N**
- **High PSRR (-90dB at 217Hz)**
- **Integrated Click-and-Pop Suppression**
- **2.7V to 5.5V Single Supply Operation**
- **Low Quiescent Current (5.6mA at $V_{DD} = 5V$)**
- **Independent Left/Right, Low-Power Shutdown Controls**
- **Short-Circuit and Thermal-Overload Protections**
- **Undervoltage Lockout Function**
- **-40°C to +85°C Operating Temperature Range**
- **Available in a Green TQFN-4x4-20L Package**

APPLICATIONS

Notebook PCs
Cellular Phones
PDAs
MP3 Players
Smart Phones
Portable Audio Equipment

PACKAGE/ORDERING INFORMATION

MODEL	GAIN (V/V)	PACKAGE DESCRIPTION	SPECIFIED TEMPERATURE RANGE	ORDERING NUMBER	PACKAGE MARKING	PACKING OPTION
SGM4914A	ADJ	TQFN-4x4-20L	-40°C to +85°C	SGM4914AYTQI20G/TR	SGM4914A YTQI20 XXXXX	Tape and Reel, 3000
SGM4914B	-2	TQFN-4x4-20L	-40°C to +85°C	SGM4914BYTQI20G/TR	SGM4914B YTQI20 XXXXX	Tape and Reel, 3000
SGM4914C	-1.5	TQFN-4x4-20L	-40°C to +85°C	SGM4914CYTQI20G/TR	SGM4914C YTQI20 XXXXX	Tape and Reel, 3000

MARKING INFORMATION

NOTE: XXXXX = Date Code and Vendor Code.

XXXXX

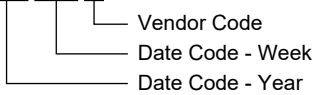

Green (RoHS & HSF): SG Micro Corp defines "Green" to mean Pb-Free (RoHS compatible) and free of halogen substances. If you have additional comments or questions, please contact your SGMICRO representative directly.

ABSOLUTE MAXIMUM RATINGS

PV _{SS} to SV _{SS}	-0.3V to +0.3V
PGND to SGND.....	-0.3V to +0.3V
PV _{DD} to SV _{DD}	-0.3V to +0.3V
PV _{DD} and SV _{DD} to PGND or SGND.....	-0.3V to +6V
PV _{SS} and SV _{SS} to PGND or SGND.....	-6V to +0.3V
IN to SGND.....	(SV _{SS} - 0.3V) to (SV _{DD} + 0.3V)
$\overline{\text{SHDN}}$ to SGND.....	-0.3V to (SV _{DD} + 0.3V)
OUT to SGND.....	(SV _{SS} - 0.3V) to (SV _{DD} + 0.3V)
C1P to PGND.....	-0.3V to (PV _{DD} + 0.3V)
C1N to PGND.....	(PV _{SS} - 0.3V) to + 0.3V
Output Short Circuit to GND or V _{DD}	Continuous
Junction Temperature.....	+150°C
Storage Temperature Range.....	-65°C to +150°C
Lead Temperature (Soldering, 10s).....	+260°C
ESD Susceptibility	
HBM.....	2000V
HBM (Output pins to Supply and Ground pins).....	4000V
MM.....	150V

RECOMMENDED OPERATING CONDITIONS

Supply Voltage Range.....	2.7V to 5.5V
Operating Temperature Range.....	-40°C to +85°C

OVERSTRESS CAUTION

Stresses beyond those listed in Absolute Maximum Ratings may cause permanent damage to the device. Exposure to absolute maximum rating conditions for extended periods may affect reliability. Functional operation of the device at any conditions beyond those indicated in the Recommended Operating Conditions section is not implied.

ESD SENSITIVITY CAUTION

This integrated circuit can be damaged by ESD if you don't pay attention to ESD protection. SGMICRO recommends that all integrated circuits be handled with appropriate precautions. Failure to observe proper handling and installation procedures can cause damage. ESD damage can range from subtle performance degradation to complete device failure. Precision integrated circuits may be more susceptible to damage because very small parametric changes could cause the device not to meet its published specifications.

DISCLAIMER

SG Micro Corp reserves the right to make any change in circuit design, or specifications without prior notice.

PIN CONFIGURATION

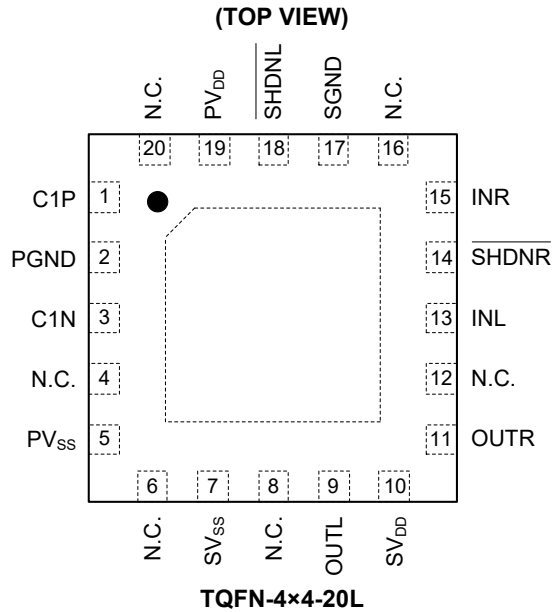

PIN DESCRIPTIONS

PIN	NAME	DESCRIPTION
1	C1P	Flying Capacitor Positive Terminal.
2	PGND	Power Ground. Connect to ground (0V).
3	C1N	Flying Capacitor Negative Terminal.
4, 6, 8, 12, 16, 20	N.C.	No Connection. Not internally connected.
5	PV _{SS}	Charge-Pump Output.
7	SV _{SS}	Amplifier Negative Power Supply. Connect to PV _{SS} .
9	OUTL	Left-Channel Output.
10	SV _{DD}	Amplifier Positive Power Supply. Connect to positive supply.
11	OUTR	Right-Channel Output.
13	INL	Left-Channel Audio Input.
14	SHDNR	Active-Low Right-Channel Shutdown. Connect to V _{DD} for normal operation.
15	INR	Right-Channel Audio Input.
17	SGND	Signal Ground. Connect to ground (0V).
18	SHDNL	Active-Low Left-Channel Shutdown. Connect to V _{DD} for normal operation.
19	PV _{DD}	Charge-Pump Power Supply. Powers charge-pump inverter, charge-pump logic, and oscillator. Connect to positive supply.
Exposed Paddle	—	Exposed Paddle. Can be connected to GND or left floating.

ELECTRICAL CHARACTERISTICS

($P_{V_{DD}} = S_{V_{DD}} = 3V$, $P_{GND} = S_{GND} = 0V$, $\overline{SHDNL} = \overline{SHDNR} = S_{V_{DD}}$, $C_1 = C_2 = 2.2\mu F$, $C_{IN} = 1\mu F$, $R_L = \infty$, $T_A = +25^\circ C$, unless otherwise noted.)⁽¹⁾

PARAMETER	SYMBOL	CONDITIONS	MIN	TYP	MAX	UNITS
General						
Supply Voltage Range	V_{DD}		2.7		5.5	V
Quiescent Supply Current	I_{DD}	One channel enabled		3.7	5.2	mA
		Two channels enabled		5.6	7.8	
Shutdown Supply Current	I_{SHDN}	$\overline{SHDNL} = \overline{SHDNR} = GND$		0.02	8	μA
\overline{SHDN} Input Logic High	V_{IH}		1.4			V
\overline{SHDN} Input Logic Low	V_{IL}				0.4	V
\overline{SHDN} Input Leakage Current			-1		+1	μA
\overline{SHDN} to Full Operation Time	t_{SON}			1.37		ms
Amplifiers						
Voltage Gain	A_V	SGM4914B	-2.09	-1.995	-1.89	V/V
		SGM4914C	-1.57	-1.495	-1.42	V/V
Gain Matching	ΔA_V			0.4		%
Output Offset Voltage	V_{OS}	Input AC-coupled to ground	-6	1	6	mV
Input Impedance	R_{IN}	SGM4914B, SGM4914C	12.6	14.6	16.5	k Ω
Power Supply Rejection Ratio	PSRR	$V_{DD} = 3.0V$, 200mV _{P-P} Ripple, SGM4914A, $A_V = -1V/V$, $C_3 = 0.1\mu F$	$f_{RIPPLE} = 217Hz$		-90	dB
			$f_{RIPPLE} = 1kHz$		-81	
			$f_{RIPPLE} = 20kHz$		-80	
Output Power	P_{OUT}	$T_A = +25^\circ C$, $R_L = 32\Omega$, THD+N $\leq 0.1\%$	$P_{V_{DD}} = S_{V_{DD}} = 5V$		95	mW
			$P_{V_{DD}} = S_{V_{DD}} = 3.6V$		50	
			$P_{V_{DD}} = S_{V_{DD}} = 3V$		35	
			$P_{V_{DD}} = S_{V_{DD}} = 2.7V$		27	
Total Harmonic Distortion Plus Noise	THD+N	$R_L = 32\Omega$, $P_{OUT} = 30mW$, $f_{IN} = 1kHz$		0.01		%
Signal-to-Noise Ratio	SNR	$P_{V_{DD}} = S_{V_{DD}} = 3V$, $R_L = 32\Omega$, $P_{OUT} = 20mW$, $f_{IN} = 1kHz$, BW = 20Hz to 20kHz, $A_V = -1V/V$		98		dB
Capacitive Drive	C_L	No sustained oscillations		200		pF
Charge-Pump Oscillator Frequency	f_{OSC}		200	320	500	kHz
Crosstalk		$R_L = 32\Omega$, $P_{OUT} = 1.6mW$, $f_{IN} = 1kHz$		85		dB
Thermal Shutdown Threshold				142		$^\circ C$
Thermal Shutdown Hysteresis				15		$^\circ C$

NOTE:

1. For C_{IN} , C_1 and etc, please refer to the FUNCTIONAL DIAGRAM/TYPICAL APPLICATION CIRCUIT on page 8.

TYPICAL PERFORMANCE CHARACTERISTICS

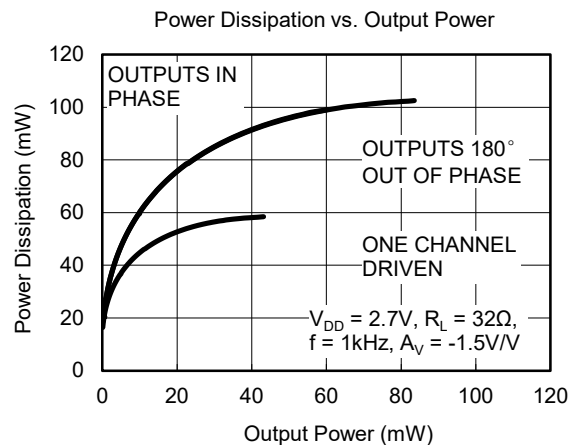
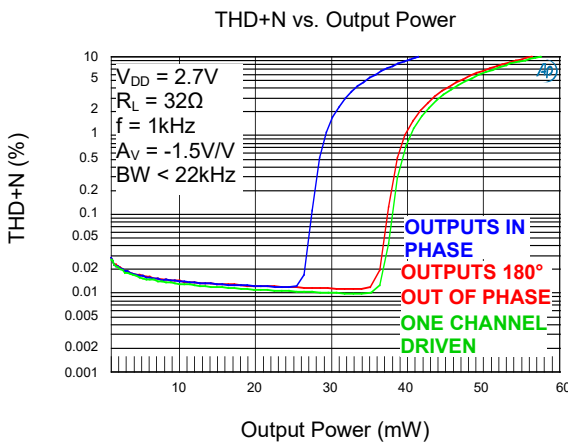
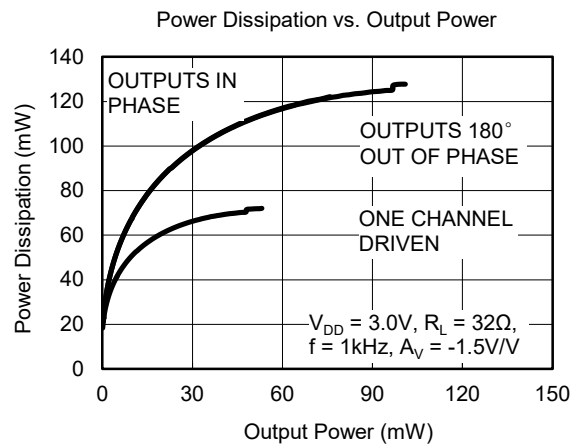
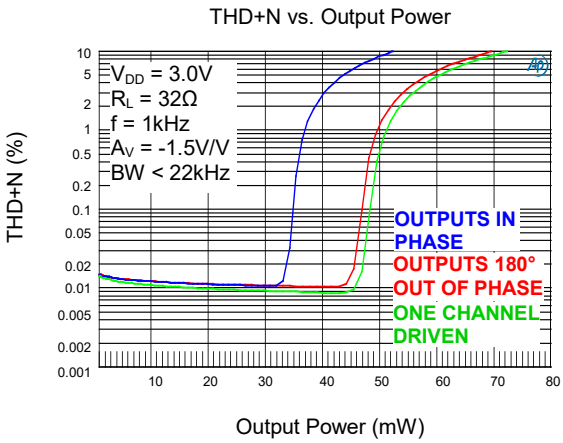
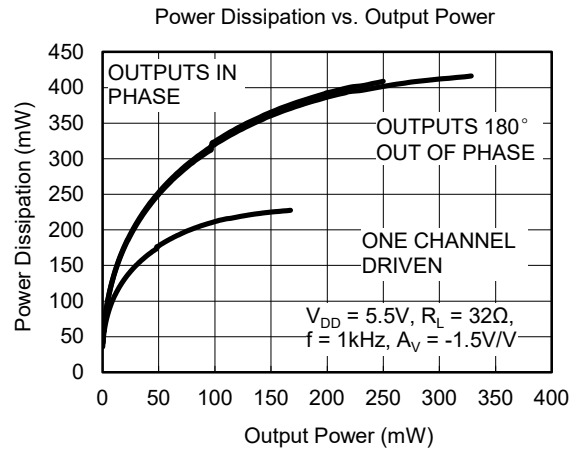
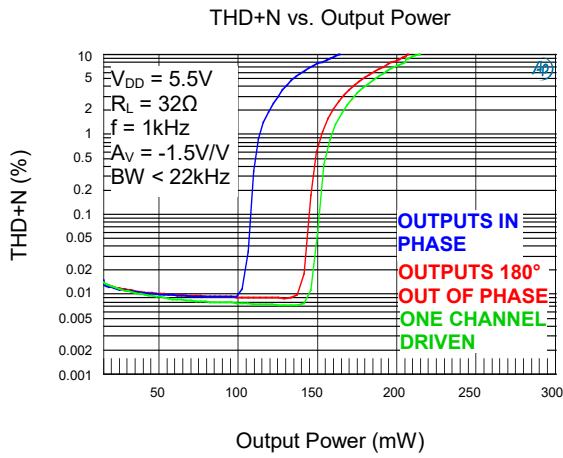

TYPICAL PERFORMANCE CHARACTERISTICS (continued)

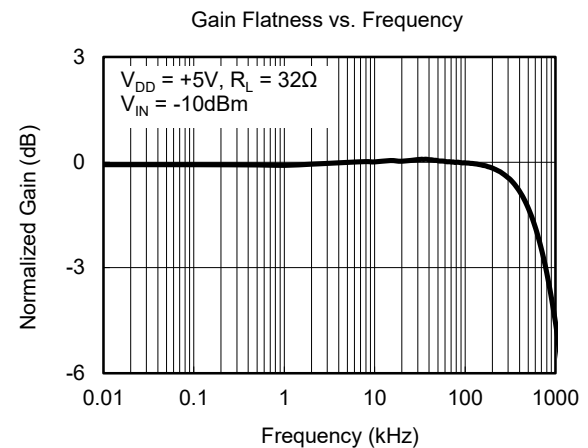
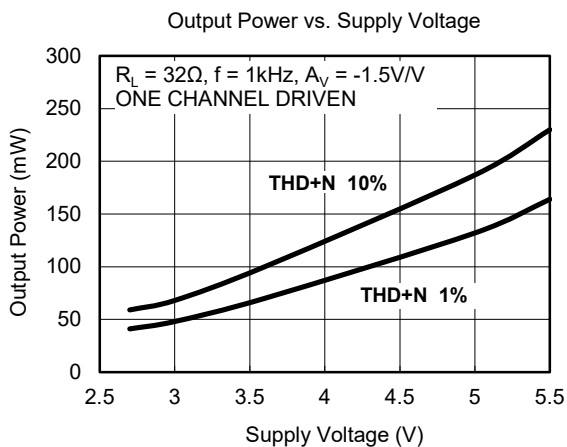
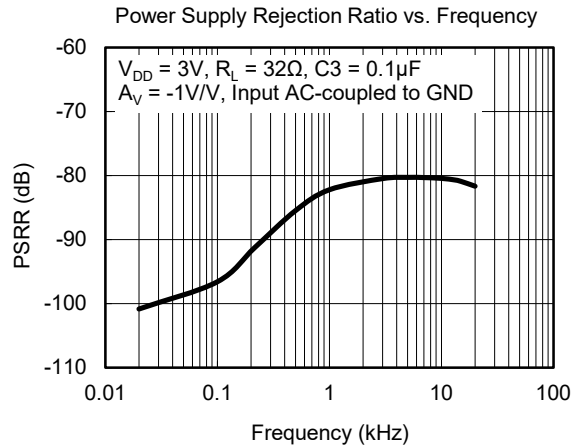
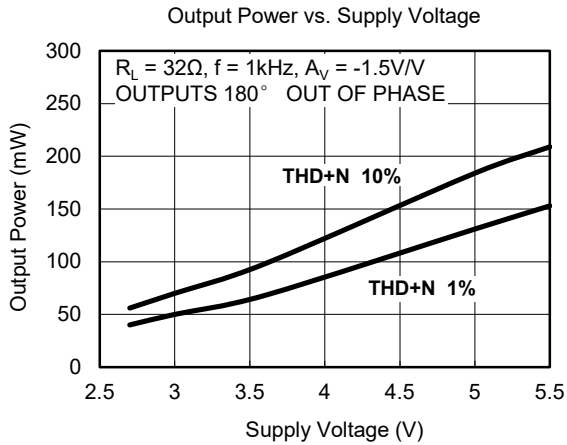
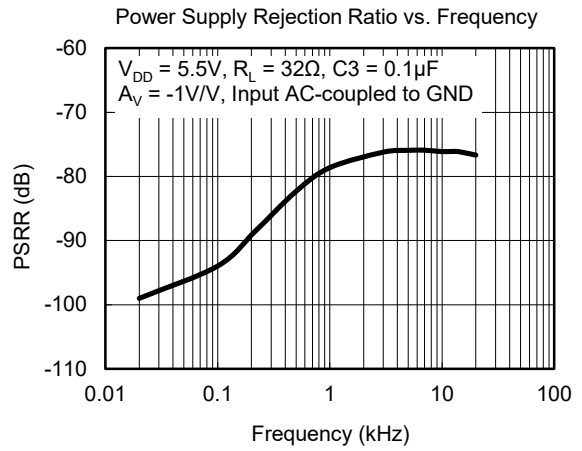
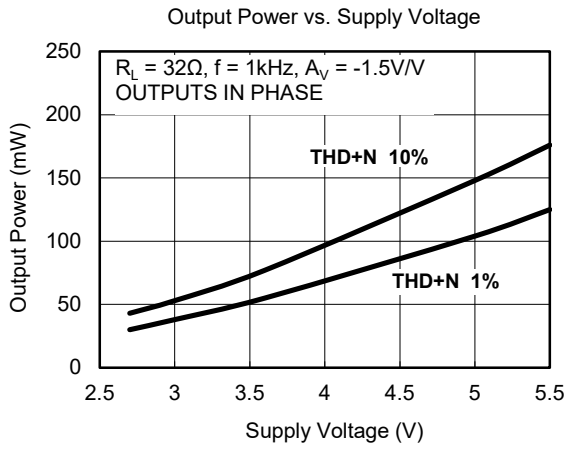

TYPICAL PERFORMANCE CHARACTERISTICS (continued)

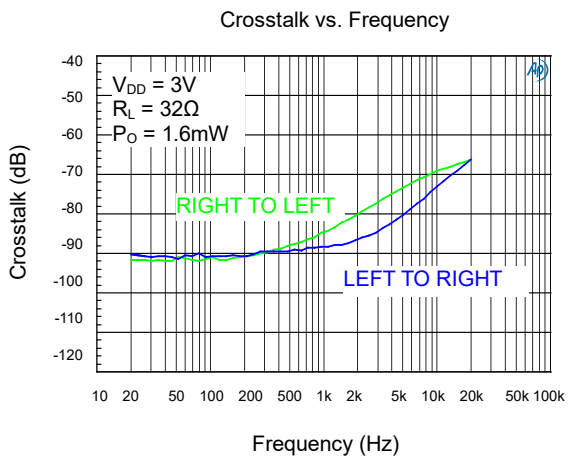

FUNCTIONAL DIAGRAM/TYPICAL APPLICATION CIRCUIT

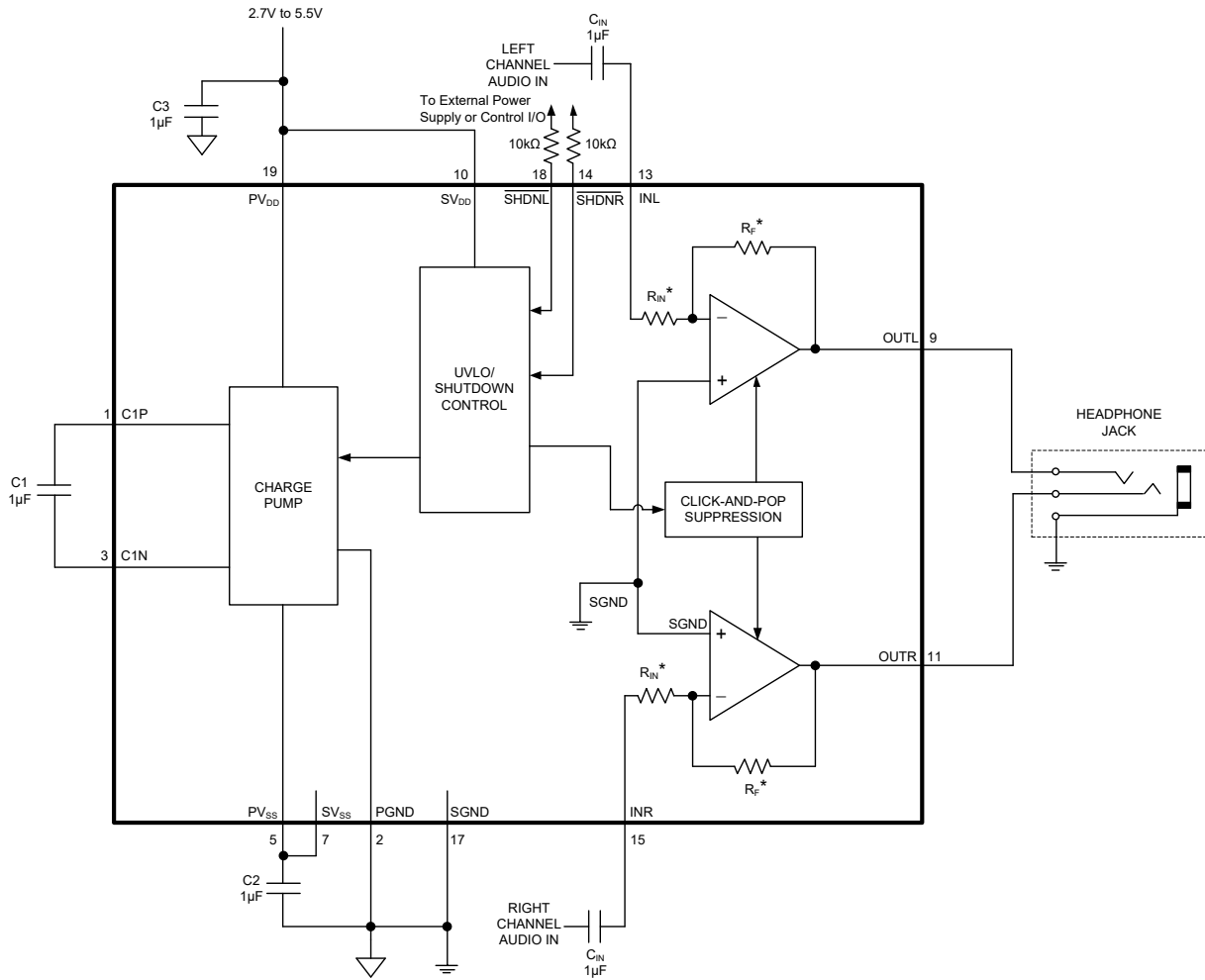

* FOR SGM4914A, R_{IN} AND R_F ARE EXTERNAL TO THE DEVICE.
 FOR SGM4914B, $R_{IN} = 15k\Omega$, $R_F = 30k\Omega$
 FOR SGM4914C, $R_{IN} = 15k\Omega$, $R_F = 22.5k\Omega$

NOTES:

1. To ensure the normal operation of the device, decoupling capacitor (C3) must be placed as close to SGM4914 as possible. The loop length formed by C3, SV_{DD} and GND should be no longer than 1.2cm; otherwise the device will not start up at high supply voltage.
2. In order to get good performance, it's important to select the right C1, C2 and C3 in application. All tests are performed with circuit set up with X5R and X7R capacitors. Capacitors having high dissipative loss, such as Y5V capacitor, may cause performance degradation and unexpected system behavior.
3. A 10kΩ resistor must be serially connected to \overline{SHDNL} or \overline{SHDNR} pin.

REVISION HISTORY

NOTE: Page numbers for previous revisions may differ from page numbers in the current version.

NOVEMBER 2012 – REV.A.1 to REV.A.2

Added note for Typical Application Circuit 8

SEPTEMBER 2012 – REV.A to REV.A.1

Added Tape and Reel Information 10-11

Changes from Original (MARCH 2012) to REV.A

Changed from product preview to production data All

PACKAGE INFORMATION

PACKAGE OUTLINE DIMENSIONS

TQFN-4×4-20L

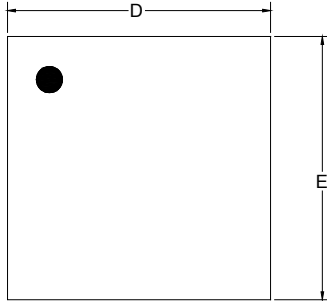

TOP VIEW

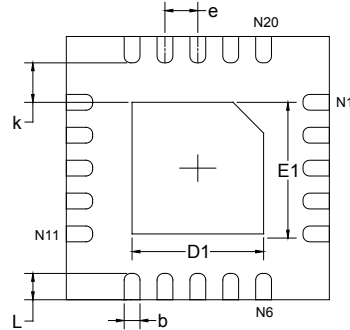

BOTTOM VIEW

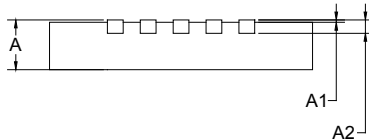

SIDE VIEW

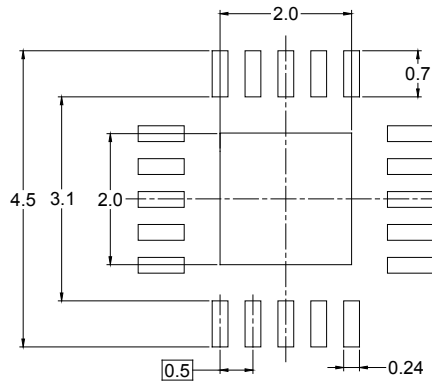

RECOMMENDED LAND PATTERN (Unit: mm)

Symbol	Dimensions In Millimeters		Dimensions In Inches	
	MIN	MAX	MIN	MAX
A	0.700	0.800	0.028	0.031
A1	0.000	0.050	0.000	0.002
A2	0.203 REF		0.008 REF	
D	3.900	4.100	0.154	0.161
D1	1.900	2.100	0.075	0.083
E	3.900	4.100	0.154	0.161
E1	1.900	2.100	0.075	0.083
k	0.200 MIN		0.008 MIN	
b	0.180	0.300	0.007	0.012
e	0.500 TYP		0.020 TYP	
L	0.300	0.500	0.012	0.020

PACKAGE INFORMATION

TAPE AND REEL INFORMATION

REEL DIMENSIONS



TAPE DIMENSIONS



NOTE: The picture is only for reference. Please make the object as the standard.

KEY PARAMETER LIST OF TAPE AND REEL

Package Type	Reel Diameter	Reel Width W1 (mm)	A0 (mm)	B0 (mm)	K0 (mm)	P0 (mm)	P1 (mm)	P2 (mm)	W (mm)	Pin1 Quadrant
TQFN-4×4-20L	13"	12.4	4.30	4.30	1.10	4.0	8.0	2.0	12.0	Q1

000001

PACKAGE INFORMATION

CARTON BOX DIMENSIONS



NOTE: The picture is only for reference. Please make the object as the standard.

KEY PARAMETER LIST OF CARTON BOX

Reel Type	Length (mm)	Width (mm)	Height (mm)	Pizza/Carton
13"	386	280	370	5

DD0002