

### GENERAL DESCRIPTION

The 74AHC08 is a quad 2-input AND gate with high-speed CMOS inputs. It has a wide supply voltage range from 2.0V to 5.5V. The over-voltage tolerant inputs are up to 5.5V. Due to this feature, the device can be used as a translator in mixed voltage environment.

### FEATURES

- **Supply Voltage Range: 2.0V to 5.5V**
- **Over-Voltage Tolerant Inputs up to 5.5V**
- **+8mA/-8mA Output Current**
- **CMOS Low Power Dissipation**
- **Balanced Propagation Delays**
- **All Inputs with Schmitt-Trigger Action**
- **-40°C to +125°C Operating Temperature Range**
- **Available in Green TSSOP-14 and SOIC-14 Packages**

### LOGIC DIAGRAM

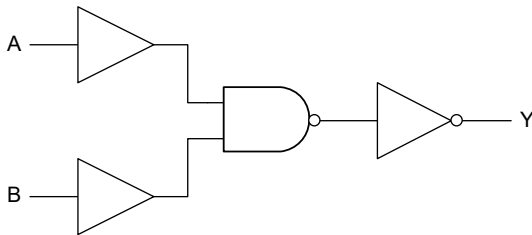

### FUNCTION TABLE

INPUT		OUTPUT
nA	nB	nY
H	H	H
L	X	L
X	L	L

$$Y = A \cdot B \text{ or } Y = \overline{\overline{A} + \overline{B}}$$

H = High Voltage Level

L = Low Voltage Level

X = Don't Care

## PACKAGE/ORDERING INFORMATION

MODEL	PACKAGE DESCRIPTION	SPECIFIED TEMPERATURE RANGE	ORDERING NUMBER	PACKAGE MARKING	PACKING OPTION
74AHC08	TSSOP-14	-40°C to +125°C	74AHC08XTS14G/TR	74AHC08 XTS14 XXXXX	Tape and Reel, 4000
	SOIC-14	-40°C to +125°C	74AHC08XS14G/TR	74AHC08XS14 XXXXX	Tape and Reel, 2500

## MARKING INFORMATION

NOTE: XXXXX = Date Code, Trace Code and Vendor Code.

**XXXXX**

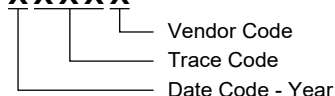

Green (RoHS & HSF): SG Micro Corp defines "Green" to mean Pb-Free (RoHS compatible) and free of halogen substances. If you have additional comments or questions, please contact your SGMICRO representative directly.

ABSOLUTE MAXIMUM RATINGS <sup>(1)</sup>

Supply Voltage Range, $V_{CC}$ .....	-0.5V to 7.0V
Input Voltage Range, $V_I$ <sup>(2)</sup> .....	-0.5V to 7.0V
Output Voltage Range, $V_O$ <sup>(2)</sup> .....	-0.5V to MIN(7.0V, $V_{CC} + 0.5V$ )
Input Clamp Current, $I_{IK}$ ( $V_I < -0.5V$ ) .....	-20mA
Output Clamp Current, $I_{OK}$ ( $V_O < -0.5V$ or $V_O > V_{CC} + 0.5V$ ) .....	$\pm 20mA$
Continuous Output Current, $I_O$ ( $V_O = -0.5V$ to $V_{CC} + 0.5V$ ) .....	$\pm 25mA$
Continuous Current through $V_{CC}$ or GND .....	$\pm 75mA$
Junction Temperature <sup>(3)</sup> .....	+150°C
Storage Temperature Range .....	-65°C to +150°C
Lead Temperature (Soldering, 10s) .....	+260°C
ESD Susceptibility	
HBM .....	4000V
CDM .....	1000V

## RECOMMENDED OPERATING CONDITIONS

Supply Voltage Range, $V_{CC}$ .....	2.0V to 5.5V
Input Voltage Range, $V_I$ .....	0V to 5.5V
Output Voltage Range, $V_O$ .....	0V to $V_{CC}$
Output Current, $I_O$ .....	$\pm 8mA$
Input Transition Rise or Fall Rate, $\Delta t/\Delta V$	
$V_{CC} = 3.3V \pm 0.3V$ .....	100ns/V (MAX)
$V_{CC} = 5.0V \pm 0.5V$ .....	20ns/V (MAX)
Operating Temperature Range .....	-40°C to +125°C

## OVERSTRESS CAUTION

- Stresses beyond those listed in Absolute Maximum Ratings may cause permanent damage to the device. Exposure to absolute maximum rating conditions for extended periods may affect reliability. Functional operation of the device at any conditions beyond those indicated in the Recommended Operating Conditions section is not implied.
- The input and output voltage ratings may be exceeded if the input and output current ratings are observed.
- The performance capability of a high-performance integrated circuit in conjunction with its thermal environment can create junction temperatures which are detrimental to reliability.

## ESD SENSITIVITY CAUTION

This integrated circuit can be damaged if ESD protections are not considered carefully. SGMICRO recommends that all integrated circuits be handled with appropriate precautions. Failure to observe proper handling and installation procedures can cause damage. ESD damage can range from subtle performance degradation to complete device failure. Precision integrated circuits may be more susceptible to damage because even small parametric changes could cause the device not to meet the published specifications.

## DISCLAIMER

SG Micro Corp reserves the right to make any change in circuit design, or specifications without prior notice.

## PIN CONFIGURATIONS

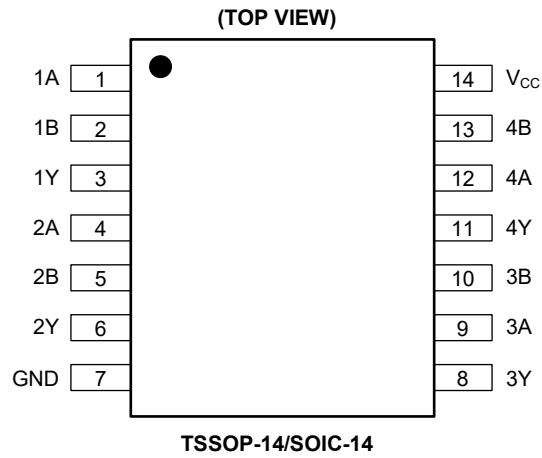

## PIN DESCRIPTION

PIN	NAME	FUNCTION
1, 4, 9, 12	1A, 2A, 3A, 4A	Data Inputs.
2, 5, 10, 13	1B, 2B, 3B, 4B	Data Inputs.
3, 6, 8, 11	1Y, 2Y, 3Y, 4Y	Data Outputs.
7	GND	Ground.
14	V <sub>CC</sub>	Supply Voltage.

PACKAGE OUTLINE DIMENSIONS

TSSOP-14

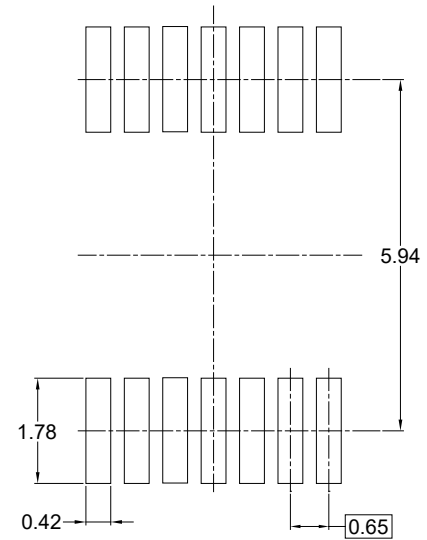
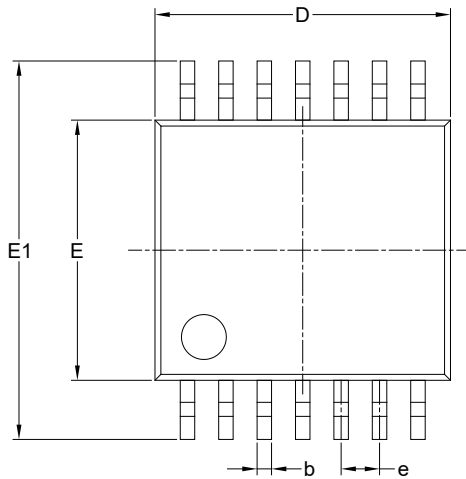

RECOMMENDED LAND PATTERN (Unit: mm)

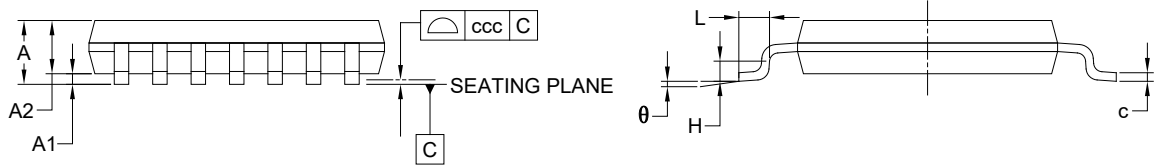

Symbol	Dimensions In Millimeters		
	MIN	MOD	MAX
A	-	-	1.200
A1	0.050	-	0.150
A2	0.800	-	1.050
b	0.190	-	0.300
c	0.090	-	0.200
D	4.860	-	5.100
E	4.300	-	4.500
E1	6.200	-	6.600
e	0.650 BSC		
L	0.450	-	0.750
H	0.250 TYP		
θ	0°	-	8°
ccc	0.100		

NOTES:

1. This drawing is subject to change without notice.
2. The dimensions do not include mold flashes, protrusions or gate burrs.
3. Reference JEDEC MO-153.

PACKAGE OUTLINE DIMENSIONS

SOIC-14

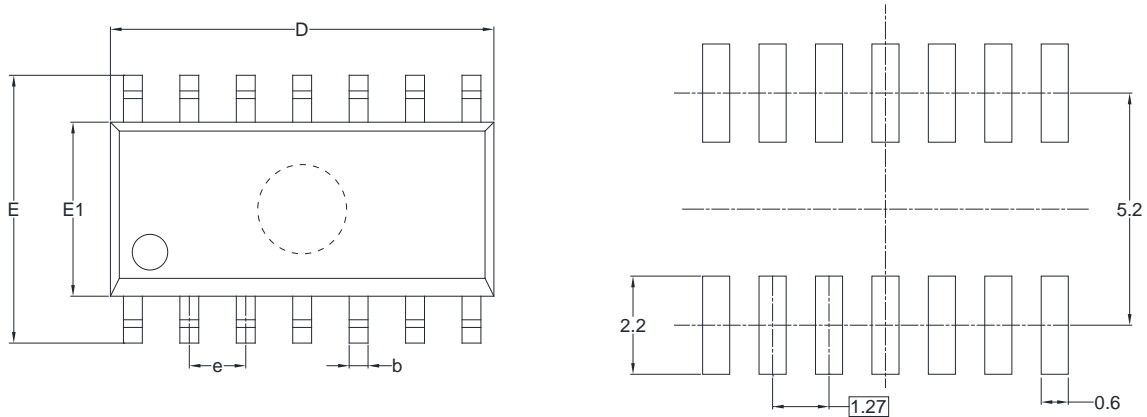

RECOMMENDED LAND PATTERN (Unit: mm)

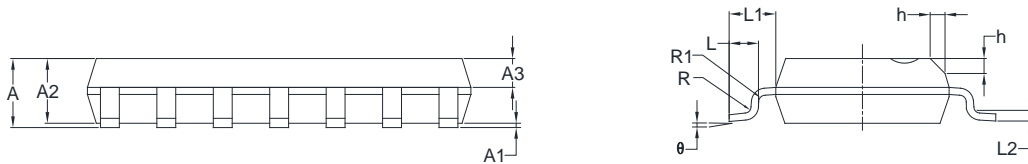

Symbol	Dimensions In Millimeters		Dimensions In Inches	
	MIN	MAX	MIN	MAX
A	1.35	1.75	0.053	0.069
A1	0.10	0.25	0.004	0.010
A2	1.25	1.65	0.049	0.065
A3	0.55	0.75	0.022	0.030
b	0.36	0.49	0.014	0.019
D	8.53	8.73	0.336	0.344
E	5.80	6.20	0.228	0.244
E1	3.80	4.00	0.150	0.157
e	1.27 BSC		0.050 BSC	
L	0.45	0.80	0.018	0.032
L1	1.04 REF		0.040 REF	
L2	0.25 BSC		0.01 BSC	
R	0.07		0.003	
R1	0.07		0.003	
h	0.30	0.50	0.012	0.020
θ	0°	8°	0°	8°

NOTES:

1. Body dimensions do not include mode flash or protrusion.
2. This drawing is subject to change without notice.

**TAPE AND REEL INFORMATION**

**REEL DIMENSIONS**

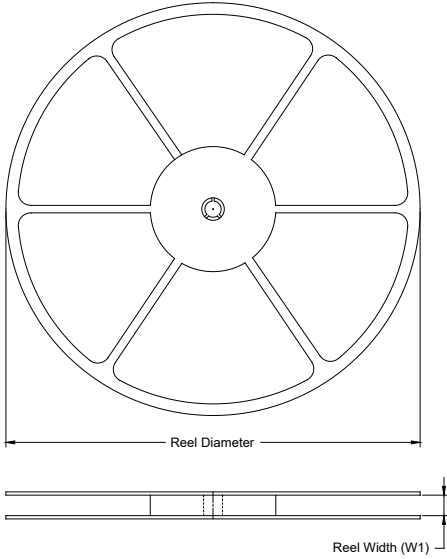

**TAPE DIMENSIONS**

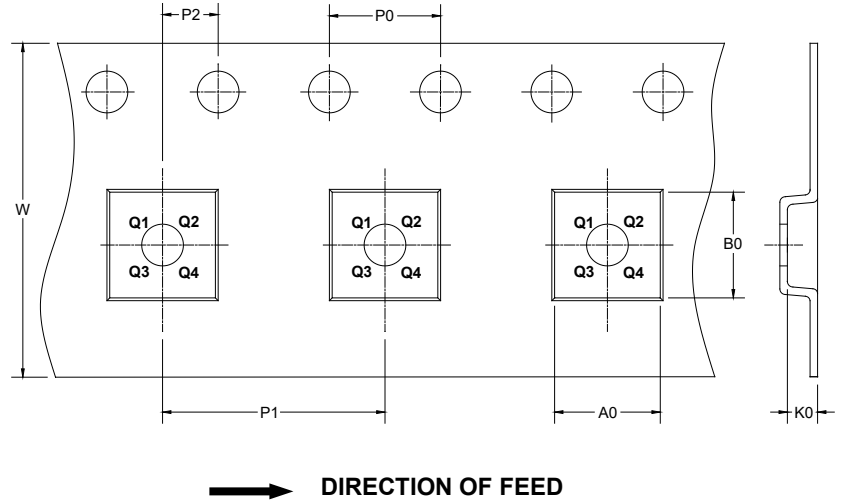

NOTE: The picture is only for reference. Please make the object as the standard.

**KEY PARAMETER LIST OF TAPE AND REEL**

Package Type	Reel Diameter	Reel Width W1 (mm)	A0 (mm)	B0 (mm)	K0 (mm)	P0 (mm)	P1 (mm)	P2 (mm)	W (mm)	Pin1 Quadrant
TSSOP-14	13"	12.4	6.80	5.40	1.50	4.0	8.0	2.0	12.0	Q1
SOIC-14	13"	16.4	6.60	9.30	2.10	4.0	8.0	2.0	16.0	Q1

DD0001

# PACKAGE INFORMATION

## CARTON BOX DIMENSIONS



NOTE: The picture is only for reference. Please make the object as the standard.

## KEY PARAMETER LIST OF CARTON BOX

Reel Type	Length (mm)	Width (mm)	Height (mm)	Pizza/Carton
13"	386	280	370	5

DD0002