

GENERAL DESCRIPTION

The SGM2221 is a low quiescent current, low dropout and high input voltage linear regulator. It is capable of supplying 300mA output current with typical dropout voltage of 330mV. The operating input voltage range is from 2.2V to 13V and fixed output voltage range is from 1.8V to 5.0V.

Other features include logic-controlled shutdown mode, short-circuit current limit and thermal shutdown protection. The SGM2221 has automatic discharge function to quickly discharge V_{OUT} in the disabled status.

The SGM2221 is available in Green SOT-23-5 and TDFN-2×2-6AL packages. It operates over an operating temperature range of -40°C to +125°C.

APPLICATIONS

Portable Electronics
 Smartphone
 Industrial and medical Equipment
 Digital Cameras and Audio Devices

FEATURES

- **Operating Input Voltage Range: 2.2V to 13V**
- **Fixed Outputs of 1.8V, 2.8V, 3.0V, 3.3V, 3.6V, 3.9V, 4.0V, 4.1V, 4.2V and 5.0V**
- **Adjustable Output from 0.8V to 5.0V**
- **Low Power Consumption:**
0.9µA (TYP) at No Load
- **Low Dropout Voltage:**
330mV (TYP) at 300mA, $V_{OUT} = 5V$
- **Current Limiting and Thermal Protection**
- **With Output Automatic Discharge**
- **Stable with Small Case Size Ceramic Capacitors**
- **Shutdown Supply Current: 0.2µA (TYP)**
- **UVLO with Hysteresis**
- **Reverse Current Protection when $V_{OUT} > V_{IN}$**
- **-40°C to +125°C Operating Temperature Range**
- **Available in Green SOT-23-5 and TDFN-2×2-6AL Packages**

TYPICAL APPLICATION

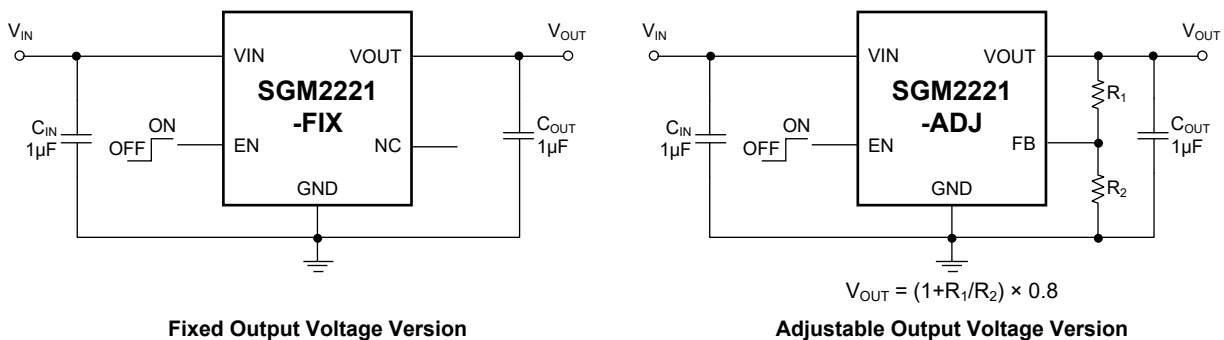

Figure 1. Typical Application Circuits

300mA, 0.9µA Low Quiescent Current, SGM2221 Low Dropout and High Voltage Regulator

PACKAGE/ORDERING INFORMATION

MODEL	PACKAGE DESCRIPTION	SPECIFIED TEMPERATURE RANGE	ORDERING NUMBER	PACKAGE MARKING	PACKING OPTION
SGM2221-1.8	SOT-23-5	-40°C to +125°C	SGM2221-1.8XN5G/TR	02CXX	Tape and Reel, 3000
SGM2221-2.8	SOT-23-5	-40°C to +125°C	SGM2221-2.8XN5G/TR	02DXX	Tape and Reel, 3000
SGM2221-3.0	SOT-23-5	-40°C to +125°C	SGM2221-3.0XN5G/TR	02EXX	Tape and Reel, 3000
SGM2221-3.3	SOT-23-5	-40°C to +125°C	SGM2221-3.3XN5G/TR	00IXX	Tape and Reel, 3000
SGM2221-3.6	SOT-23-5	-40°C to +125°C	SGM2221-3.6XN5G/TR	02FXX	Tape and Reel, 3000
SGM2221-3.9	SOT-23-5	-40°C to +125°C	SGM2221-3.9XN5G/TR	02GXX	Tape and Reel, 3000
SGM2221-4.0	SOT-23-5	-40°C to +125°C	SGM2221-4.0XN5G/TR	02HXX	Tape and Reel, 3000
SGM2221-4.1	SOT-23-5	-40°C to +125°C	SGM2221-4.1XN5G/TR	02IXX	Tape and Reel, 3000
SGM2221-4.2	SOT-23-5	-40°C to +125°C	SGM2221-4.2XN5G/TR	02JXX	Tape and Reel, 3000
SGM2221-5.0	SOT-23-5	-40°C to +125°C	SGM2221-5.0XN5G/TR	00JXX	Tape and Reel, 3000
SGM2221-ADJ	SOT-23-5	-40°C to +125°C	SGM2221-ADJXN5G/TR	00KXX	Tape and Reel, 3000
SGM2221-1.8	TDFN-2x2-6AL	-40°C to +125°C	SGM2221-1.8XTDI6G/TR	00B XXXX	Tape and Reel, 3000
SGM2221-2.8	TDFN-2x2-6AL	-40°C to +125°C	SGM2221-2.8XTDI6G/TR	02K XXXX	Tape and Reel, 3000
SGM2221-3.0	TDFN-2x2-6AL	-40°C to +125°C	SGM2221-3.0XTDI6G/TR	02L XXXX	Tape and Reel, 3000
SGM2221-3.3	TDFN-2x2-6AL	-40°C to +125°C	SGM2221-3.3XTDI6G/TR	00C XXXX	Tape and Reel, 3000
SGM2221-3.6	TDFN-2x2-6AL	-40°C to +125°C	SGM2221-3.6XTDI6G/TR	02M XXXX	Tape and Reel, 3000
SGM2221-3.9	TDFN-2x2-6AL	-40°C to +125°C	SGM2221-3.9XTDI6G/TR	02N XXXX	Tape and Reel, 3000
SGM2221-4.0	TDFN-2x2-6AL	-40°C to +125°C	SGM2221-4.0XTDI6G/TR	02P XXXX	Tape and Reel, 3000
SGM2221-4.1	TDFN-2x2-6AL	-40°C to +125°C	SGM2221-4.1XTDI6G/TR	02Q XXXX	Tape and Reel, 3000
SGM2221-4.2	TDFN-2x2-6AL	-40°C to +125°C	SGM2221-4.2XTDI6G/TR	02R XXXX	Tape and Reel, 3000
SGM2221-5.0	TDFN-2x2-6AL	-40°C to +125°C	SGM2221-5.0XTDI6G/TR	00D XXXX	Tape and Reel, 3000
SGM2221-ADJ	TDFN-2x2-6AL	-40°C to +125°C	SGM2221-ADJXTDI6G/TR	00E XXXX	Tape and Reel, 3000

MARKING INFORMATION

NOTE: XX = Date Code. XXXX = Date Code, Trace Code and Vendor Code.

SOT-23-5

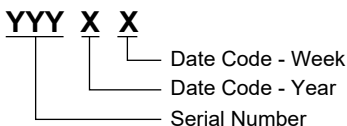

TDFN-2x2-6AL

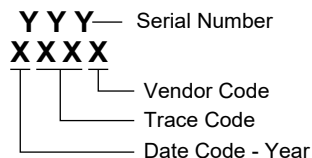

Green (RoHS & HSF): SG Micro Corp defines "Green" to mean Pb-Free (RoHS compatible) and free of halogen substances. If you have additional comments or questions, please contact your SGMICRO representative directly.

ABSOLUTE MAXIMUM RATINGS

VIN, EN to GND	-0.3V to 16V
VOUT to GND	-0.3V to 6V
Package Thermal Resistance	
SOT-23-5, θ_{JA}	161°C/W
SOT-23-5, θ_{JB}	39°C/W
SOT-23-5, $\theta_{JC(TOP)}$	111°C/W
TDFN-2 \times 2-6AL, θ_{JA}	82°C/W
TDFN-2 \times 2-6AL, θ_{JB}	41°C/W
TDFN-2 \times 2-6AL, $\theta_{JC(TOP)}$	89°C/W
TDFN-2 \times 2-6AL, $\theta_{JC(BOT)}$	17°C/W
Junction Temperature	+150°C
Storage Temperature Range	-65°C to +150°C
Lead Temperature (Soldering, 10s)	+260°C
ESD Susceptibility	
HBM	6000V
CDM	1000V

RECOMMENDED OPERATING CONDITIONS

Input Voltage Range	2.2V to 13V
Input Effective Capacitance, C_{IN}	0.5 μ F (MIN)
Output Effective Capacitance, C_{OUT}	0.47 μ F to 10 μ F
Operating Junction Temperature Range	-40°C to +125°C

OVERSTRESS CAUTION

Stresses beyond those listed in Absolute Maximum Ratings may cause permanent damage to the device. Exposure to absolute maximum rating conditions for extended periods may affect reliability. Functional operation of the device at any conditions beyond those indicated in the Recommended Operating Conditions section is not implied.

ESD SENSITIVITY CAUTION

This integrated circuit can be damaged if ESD protections are not considered carefully. SGMICRO recommends that all integrated circuits be handled with appropriate precautions. Failure to observe proper handling and installation procedures can cause damage. ESD damage can range from subtle performance degradation to complete device failure. Precision integrated circuits may be more susceptible to damage because even small parametric changes could cause the device not to meet the published specifications.

DISCLAIMER

SG Micro Corp reserves the right to make any change in circuit design, or specifications without prior notice.

PIN CONFIGURATIONS

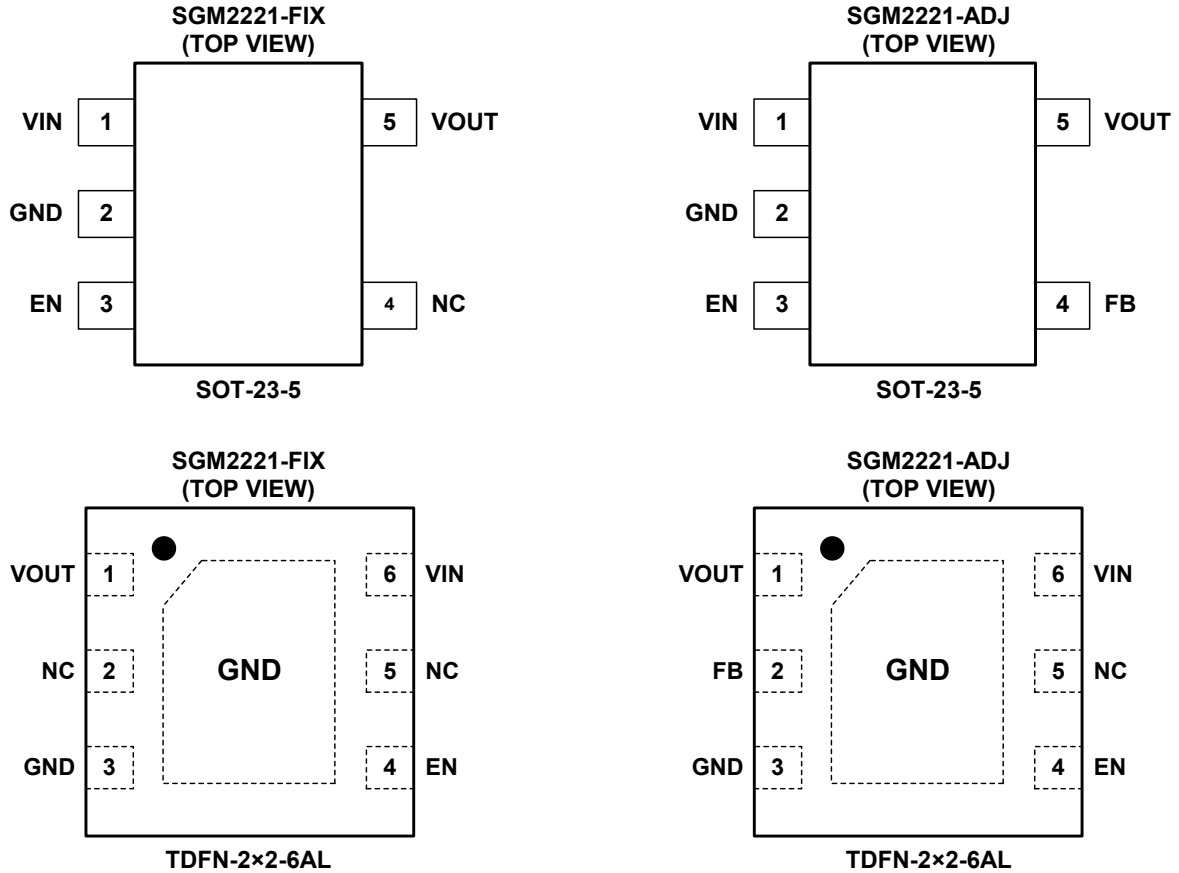

PIN DESCRIPTION

PIN		NAME	FUNCTION
SOT-23-5	TDFN-2x2-6AL		
1	6	VIN	Input Supply Voltage Pin. It is recommended to use a 1µF or larger ceramic capacitor from VIN pin to ground to get good power supply decoupling. This ceramic capacitor should be placed as close as possible to VIN pin.
2	3	GND	Ground.
3	4	EN	Enable Pin. Drive EN high to turn on the regulator. Drive EN low to turn off the regulator.
4	2	NC	No Connection (fixed voltage version only).
		FB	Feedback Voltage Input Pin (adjustable voltage version only). Connect this pin to the midpoint of an external resistor divider to adjust the output voltage. Place the resistors as close as possible to this pin.
5	1	VOUT	Regulator Output Pin. It is recommended to use a ceramic capacitor with effective capacitance in the range of 0.47µF to 10µF to ensure stability. This ceramic capacitor should be placed as close as possible to VOUT pin.

PACKAGE INFORMATION

PACKAGE OUTLINE DIMENSIONS

SOT-23-5

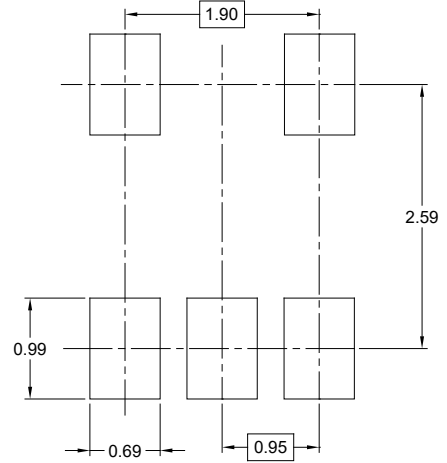
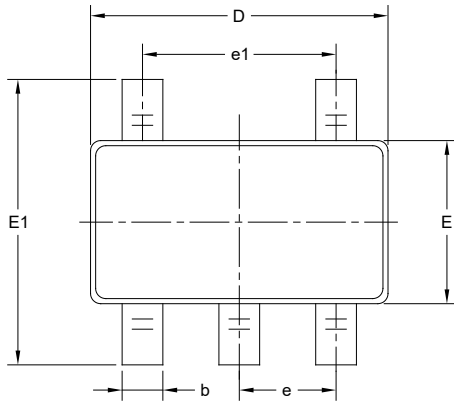

RECOMMENDED LAND PATTERN (Unit: mm)

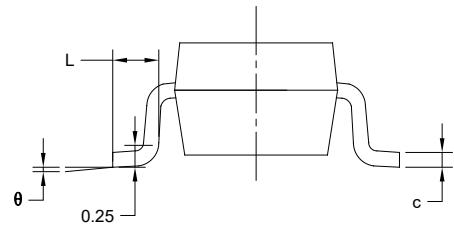
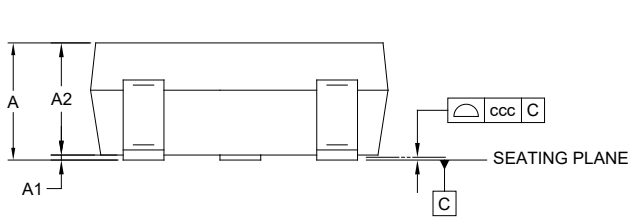

Symbol	Dimensions In Millimeters		
	MIN	MOD	MAX
A	-	-	1.450
A1	0.000	-	0.150
A2	0.900	-	1.300
b	0.300	-	0.500
c	0.080	-	0.220
D	2.750	-	3.050
E	1.450	-	1.750
E1	2.600	-	3.000
e	0.950 BSC		
e1	1.900 BSC		
L	0.300	-	0.600
θ	0°	-	8°
ccc	0.100		

NOTES:

1. This drawing is subject to change without notice.
2. The dimensions do not include mold flashes, protrusions or gate burrs.
3. Reference JEDEC MO-178.

PACKAGE OUTLINE DIMENSIONS

TDFN-2x2-6AL

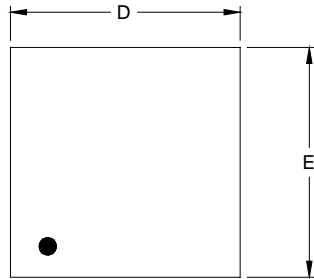

TOP VIEW

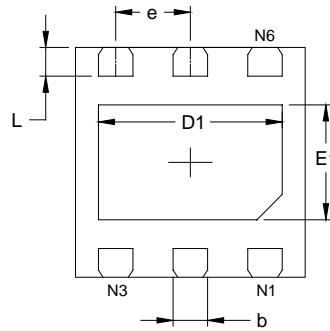

BOTTOM VIEW

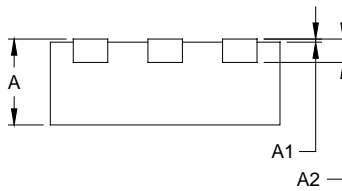

SIDE VIEW

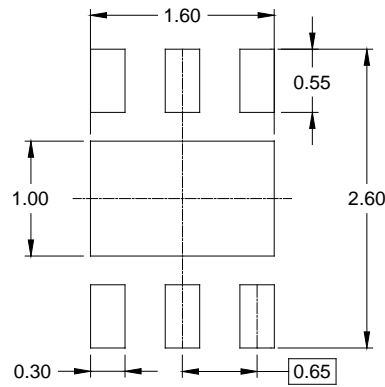

RECOMMENDED LAND PATTERN (Unit: mm)

Symbol	Dimensions In Millimeters		Dimensions In Inches	
	MIN	MAX	MIN	MAX
A	0.700	0.800	0.028	0.031
A1	0.000	0.050	0.000	0.002
A2	0.203 REF		0.008 REF	
D	1.900	2.100	0.075	0.083
D1	1.500	1.700	0.059	0.067
E	1.900	2.100	0.075	0.083
E1	0.900	1.100	0.035	0.043
b	0.250	0.350	0.010	0.014
e	0.650 BSC		0.026 BSC	
L	0.174	0.326	0.007	0.013

NOTE: This drawing is subject to change without notice.

TAPE AND REEL INFORMATION

REEL DIMENSIONS



TAPE DIMENSIONS



NOTE: The picture is only for reference. Please make the object as the standard.

KEY PARAMETER LIST OF TAPE AND REEL

Package Type	Reel Diameter	Reel Width W1 (mm)	A0 (mm)	B0 (mm)	K0 (mm)	P0 (mm)	P1 (mm)	P2 (mm)	W (mm)	Pin1 Quadrant
SOT-23-5	7"	9.5	3.20	3.20	1.40	4.0	4.0	2.0	8.0	Q3
TDFN-2×2-6AL	7"	9.5	2.30	2.30	1.10	4.0	4.0	2.0	8.0	Q1

DD0001

PACKAGE INFORMATION

CARTON BOX DIMENSIONS



NOTE: The picture is only for reference. Please make the object as the standard.

KEY PARAMETER LIST OF CARTON BOX

Reel Type	Length (mm)	Width (mm)	Height (mm)	Pizza/Carton
7" (Option)	368	227	224	8
7"	442	410	224	18

DD0002