

GENERAL DESCRIPTION

The SGM2554 is a single channel power distribution switch. The switch operates from a wide range of 2.2V to 5.5V supply voltage, and is controlled by the EN pin. It can be used in USB power distribution applications.

A 95mΩ low R_{ON} N-MOSFET is integrated. The small size and quiescent current make the device very suitable for space limited, battery-powered applications.

A number of protection features are provided in the device including soft-start, current limit of 1.85A and thermal shutdown. The internal reverse-voltage function will protect devices on the input side of the switch.

The SGM2554 is available in a Green SOT-23-5 package and is rated over the -40°C to +85°C temperature range.

FEATURES

- **Input Voltage Range: 2.2V to 5.5V**
- **On-Resistance: 95mΩ (TYP)**
- **Continuous Current: 1.1A**
- **Current Limit: 1.85A**
- **Quiescent Current: 19μA (TYP)**
- **Shutdown Current: 1μA (MAX)**
- **Full Set of Protections**
 - ◆ **Soft-Start**
 - ◆ **Under-Voltage Lockout for VIN**
 - ◆ **No Reversed Leakage Current**
 - ◆ **Thermal Shutdown**
- **Evaluated to IEC 60950-1, Ed 2, Am1, Annex CC, Test Program 1 with CB Report**
- **Available in a Green SOT-23-5 Package**

APPLICATIONS

- Digital TV
- Set-Top Box
- Portable Medical Equipment
- Battery Powered Equipment
- Hot-Plug Power Supply
- Motherboard USB Power Switch
- USB Device Power Switch

TYPICAL APPLICATION

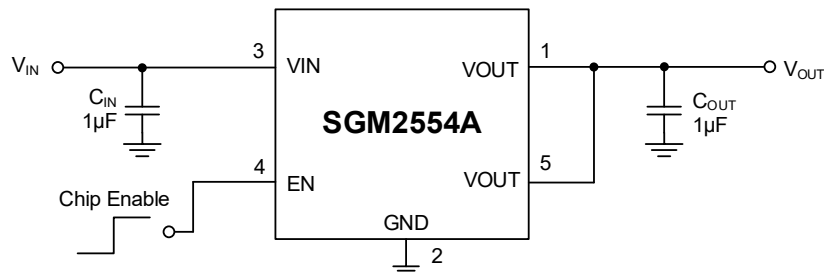

PACKAGE/ORDERING INFORMATION

MODEL	PACKAGE DESCRIPTION	SPECIFIED TEMPERATURE RANGE	ORDERING NUMBER	PACKAGE MARKING	PACKING OPTION
SGM2554A	SOT-23-5	-40°C to +85°C	SGM2554AYN5G/TR	SI4XX	Tape and Reel, 3000
SGM2554B	SOT-23-5	-40°C to +85°C	SGM2554BYN5G/TR	SI5XX	Tape and Reel, 3000

MARKING INFORMATION

NOTE: XX = Date Code.

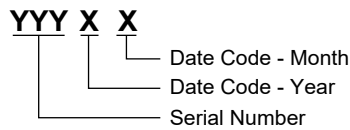

Green (RoHS & HSF): SG Micro Corp defines "Green" to mean Pb-Free (RoHS compatible) and free of halogen substances. If you have additional comments or questions, please contact your SGMICRO representative directly.

ABSOLUTE MAXIMUM RATINGS

- Input Supply Voltage..... 6V
- EN Pin..... -0.3V to 6V
- Operating Temperature Range-40°C to +85°C
- Package Thermal Resistance
- SOT-23-5, θ_{JA} 250°C/W
- Junction Temperature..... +150°C
- Storage Temperature Range-65°C to +150°C
- Lead Temperature (Soldering, 10s)..... +260°C
- ESD Susceptibility
- HBM..... 2000V
- MM..... 300V

OVERSTRESS CAUTION

Stresses beyond those listed in Absolute Maximum Ratings may cause permanent damage to the device. Exposure to absolute maximum rating conditions for extended periods may affect reliability. Functional operation of the device at any conditions beyond those indicated in the Recommended Operating Conditions section is not implied.

ESD SENSITIVITY CAUTION

This integrated circuit can be damaged if ESD protections are not considered carefully. SGMICRO recommends that all integrated circuits be handled with appropriate precautions. Failure to observe proper handling and installation procedures can cause damage. ESD damage can range from subtle performance degradation to complete device failure. Precision integrated circuits may be more susceptible to damage because even small parametric changes could cause the device not to meet the published specifications.

DISCLAIMER

SG Micro Corp reserves the right to make any change in circuit design, or specifications without prior notice.

PIN CONFIGURATIONS

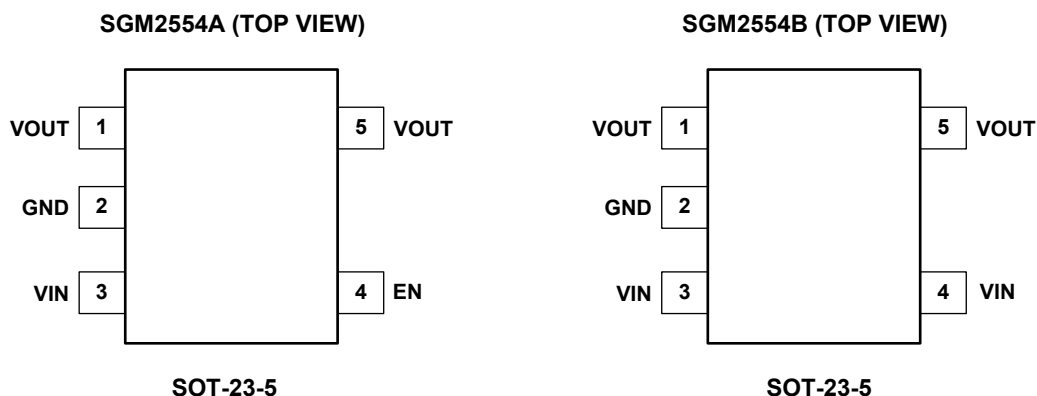

PIN DESCRIPTION

PIN		NAME	FUNCTION
SGM2554A	SGM2554B		
1, 5	1, 5	VOUT	Switch Output.
2	2	GND	Ground.
3	3, 4	VIN	Switch Input.
4	—	EN	Chip Enable Pin. Logic high to enable the device.

FUNCTION BLOCK DIAGRAM

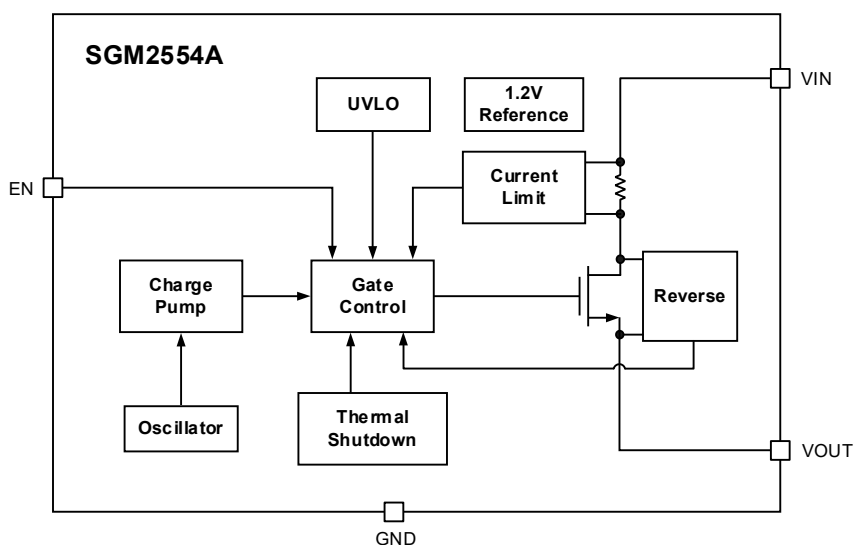

ELECTRICAL CHARACTERISTICS(At $T_A = +25^\circ\text{C}$, $V_{IN} = 5\text{V}$, $C_{IN} = C_{OUT} = 1\mu\text{F}$, unless otherwise noted.)

PARAMETER		SYMBOL	CONDITIONS	MIN	TYP	MAX	UNITS
Input Voltage Range		V_{IN}		2.2		5.5	V
Quiescent Current		I_Q	$V_{IN} = 3\text{V}, V_{EN} = 3\text{V}$		18	27	μA
			$V_{IN} = 5\text{V}, V_{EN} = 5\text{V}$		19	30	
Shutdown Current	SGM2554A	I_{SD}	$V_{EN} = 0\text{V}$		0.1	1	μA
Output Leakage Current	SGM2554A	$I_{LEAKAGE}$	$V_{EN} = 0\text{V}, V_{OUT} = 0\text{V}$		0.1	1	μA
EN Input Threshold	SGM2554A	V_{IH}		1.5			V
		V_{IL}				0.4	
Output Turn-On Delay Time		t_{ON}	$R_L = 30\Omega, C_{OUT} = 1\mu\text{F}$		1.1		ms
Switch Resistance		$R_{DS(ON)}$	$I_L = 1\text{A}$		95	150	$\text{m}\Omega$
Current Limit Threshold	SGM2554A	I_{LIM}	$R_L = 2\Omega$		1.85		A
	SGM2554B		$R_L = 2\Omega$		1.75		
Short-Circuit Output Current	SGM2554A	I_{SHORT}	$V_{OUT} = 0\text{V}, V_{IN} = 3\text{V}$		1.2		A
	SGM2554B		$V_{OUT} = 0\text{V}, V_{IN} = 3\text{V}$		1.1		
Under-Voltage Lockout Threshold		V_{UVLO}	V_{IN} Rising		1.65		V
Under-Voltage Lockout Threshold Hysteresis					50		mV
Thermal Shutdown Threshold		T_{TSD}	T_J increasing		125		$^\circ\text{C}$
Thermal Shutdown Hysteresis		T_{HYS}			20		$^\circ\text{C}$

TEST CIRCUITS

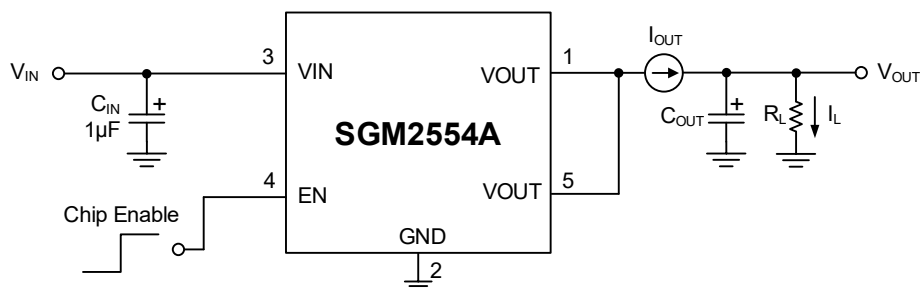

Test Circuit 1

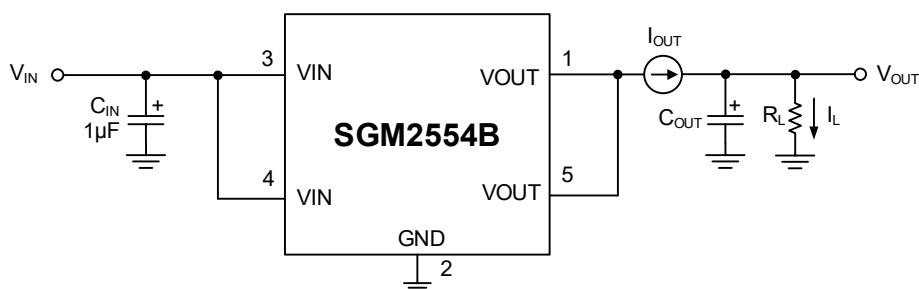

Test Circuit 2

TIMING DIAGRAM

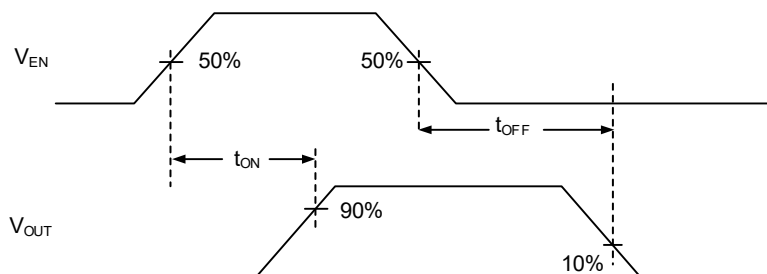

Switch Turn-On or Turn-Off Delay Time

TYPICAL PERFORMANCE CHARACTERISTICS

At $T_A = +25^\circ\text{C}$, $V_{IN} = V_{EN} = 5\text{V}$, $C_{IN} = C_{OUT} = 1\mu\text{F}$, unless otherwise noted.

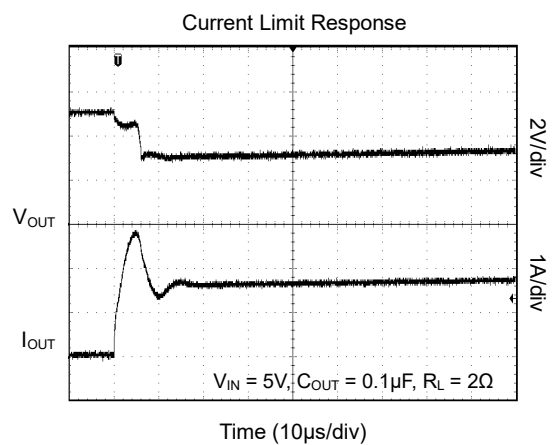
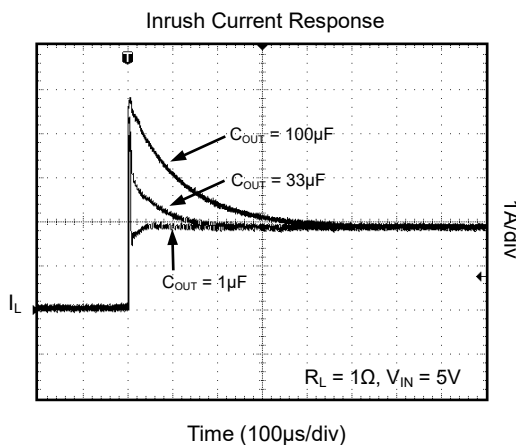
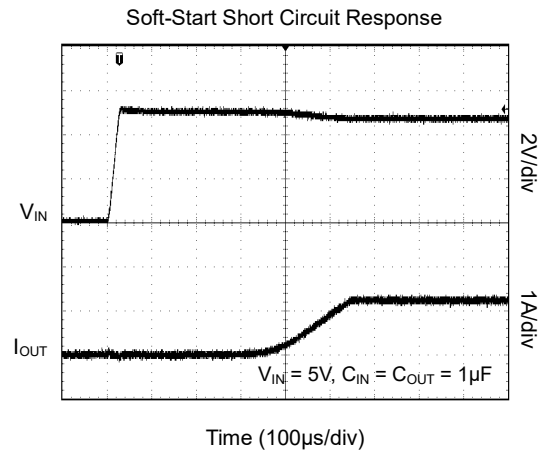
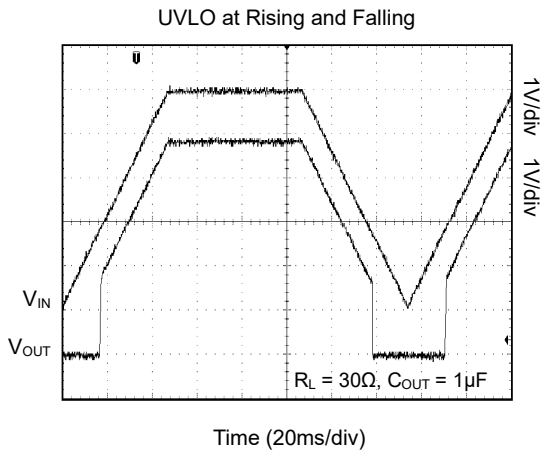
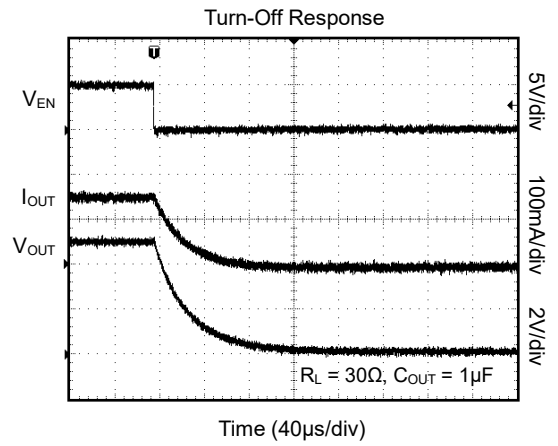
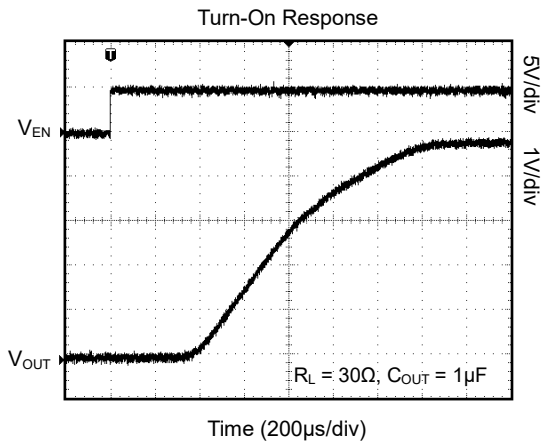

TYPICAL PERFORMANCE CHARACTERISTICS (continued)

At $T_A = +25^\circ\text{C}$, $V_{IN} = V_{EN} = 5\text{V}$, $C_{IN} = C_{OUT} = 1\mu\text{F}$, unless otherwise noted.

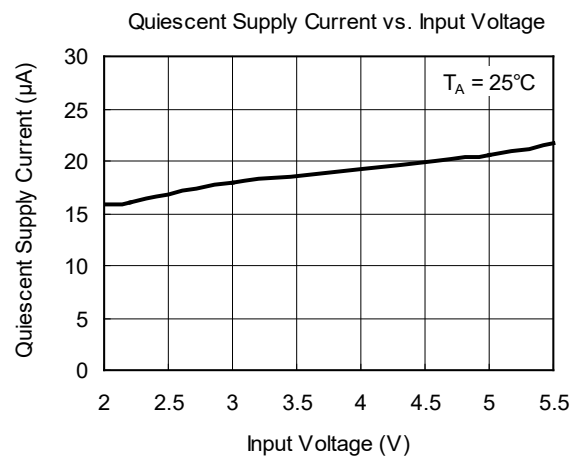
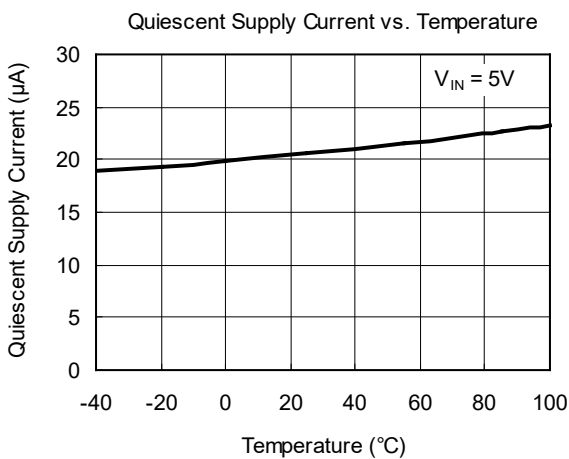
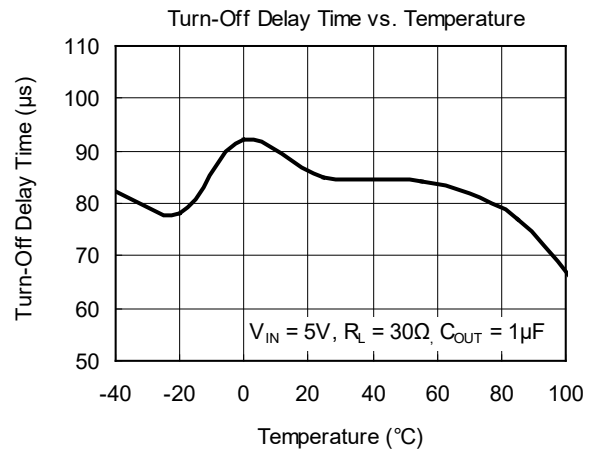
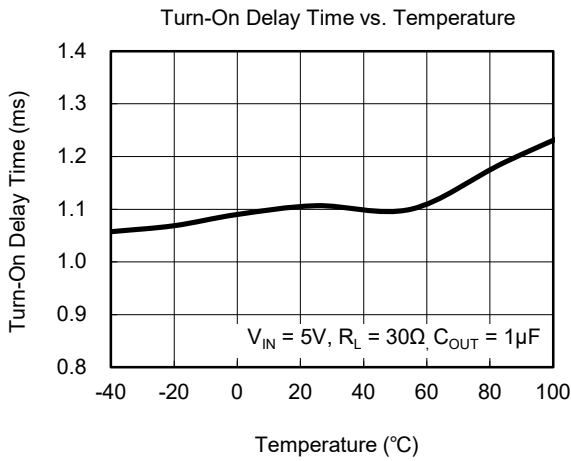
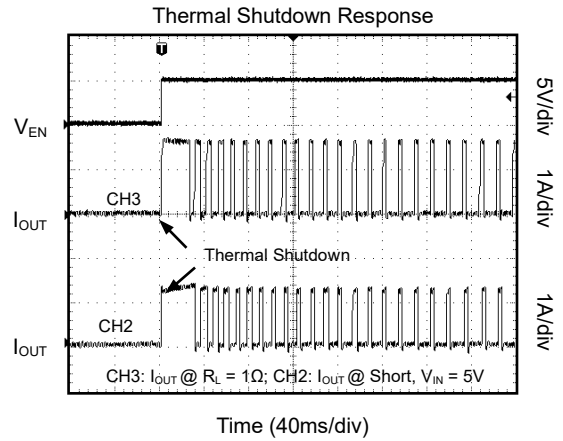
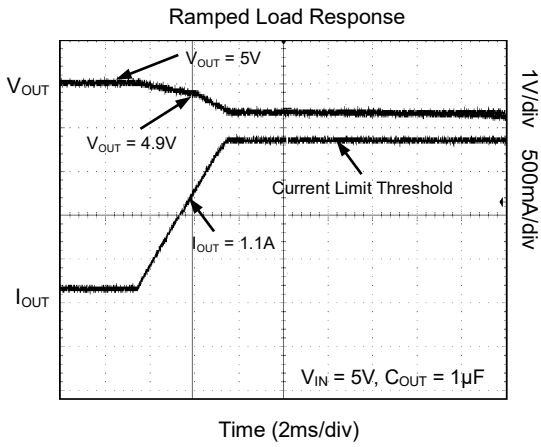

TYPICAL PERFORMANCE CHARACTERISTICS (continued)

At $T_A = +25^\circ\text{C}$, $V_{IN} = V_{EN} = 5\text{V}$, $C_{IN} = C_{OUT} = 1\mu\text{F}$, unless otherwise noted.

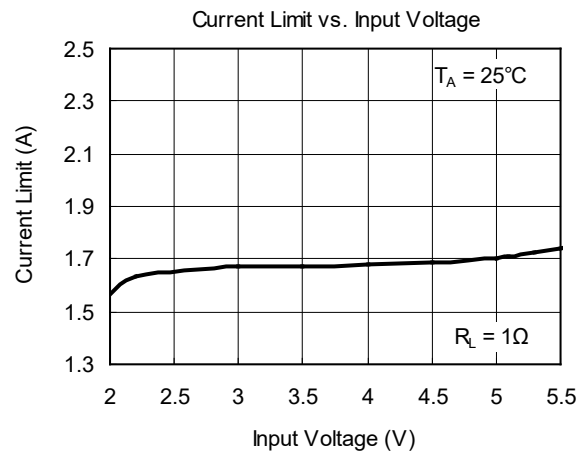
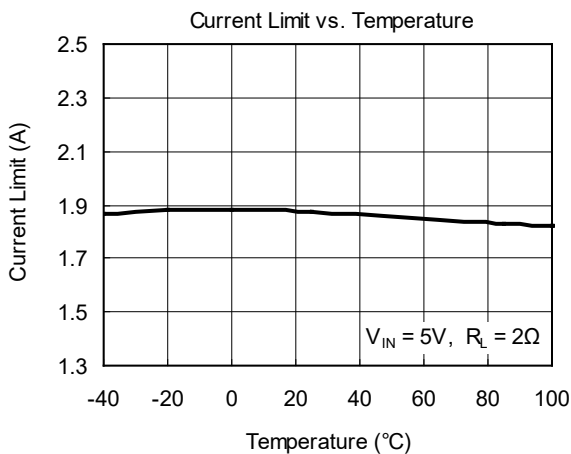
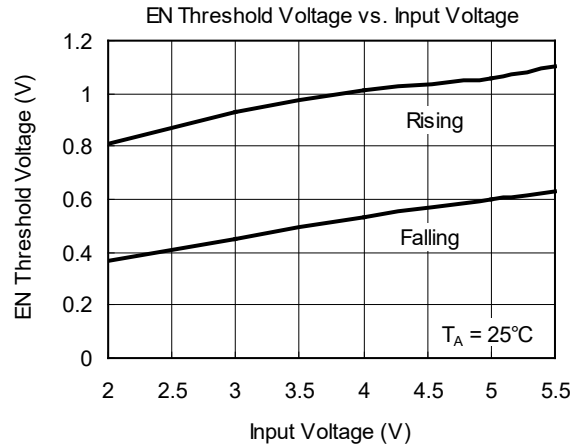
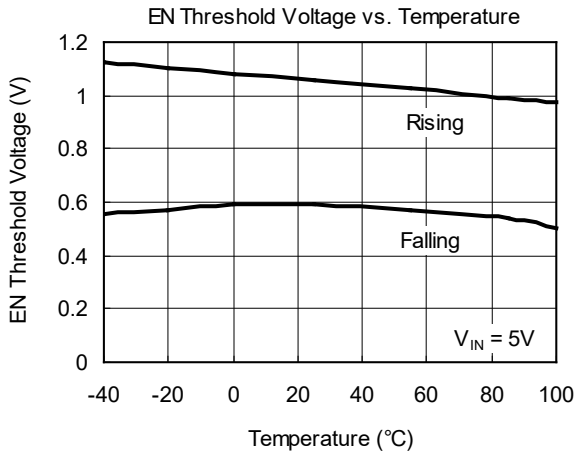
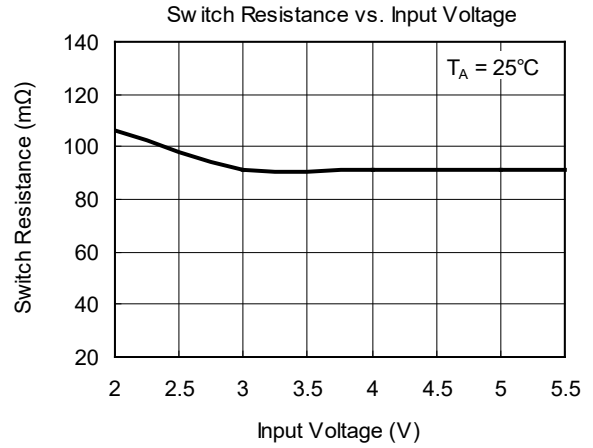
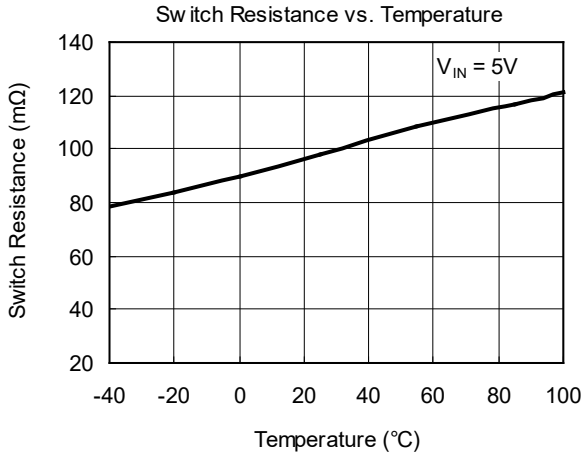

TYPICAL PERFORMANCE CHARACTERISTICS (continued)

At $T_A = +25^\circ\text{C}$, $V_{IN} = V_{EN} = 5\text{V}$, $C_{IN} = C_{OUT} = 1\mu\text{F}$, unless otherwise noted.

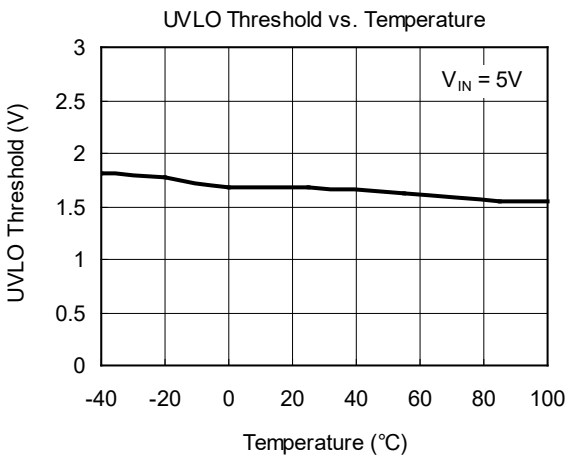
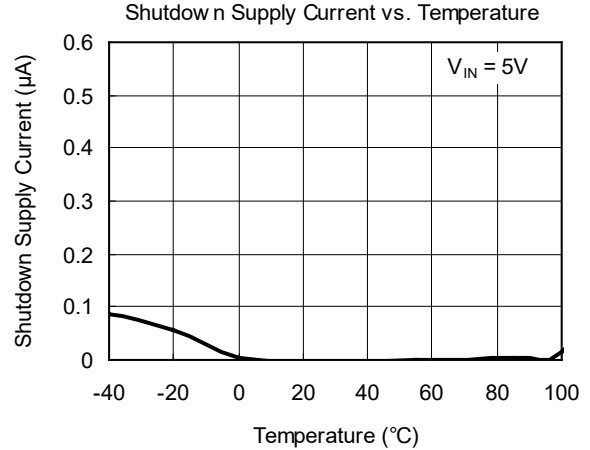
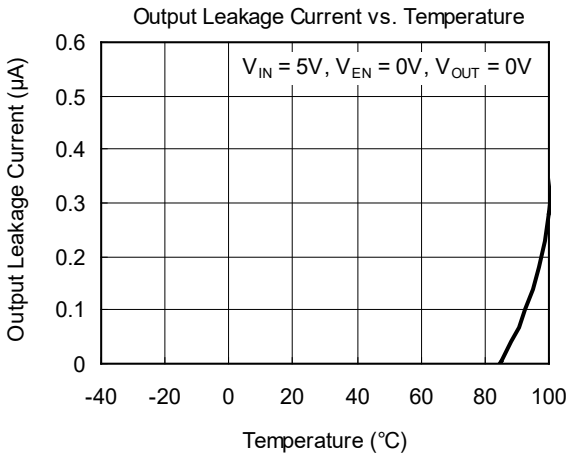
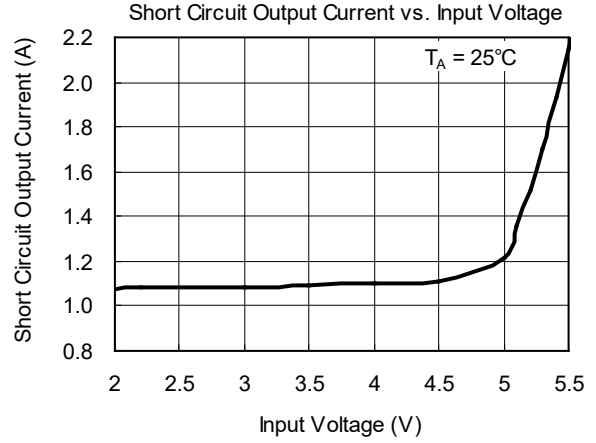
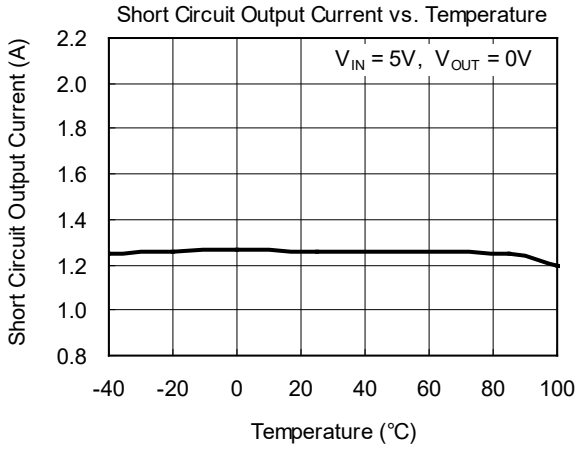

REVISION HISTORY

NOTE: Page numbers for previous revisions may differ from page numbers in the current version.

APRIL 2022 – REV.A.3 to REV.A.4	Page
Update Package Outline Dimensions section	11

DECEMBER 2017 – REV.A.2 to REV.A.3	Page
Update Feature section	1

APRIL 2016 – REV.A.1 to REV.A.2	Page
New version.....	All

JANUARY 2014 – REV.A to REV.A.1	Page
Changed Electrical Characteristics section	4

Changes from Original (MAY 2013) to REV.A	Page
Changed from product preview to production data.....	All

PACKAGE INFORMATION

PACKAGE OUTLINE DIMENSIONS

SOT-23-5

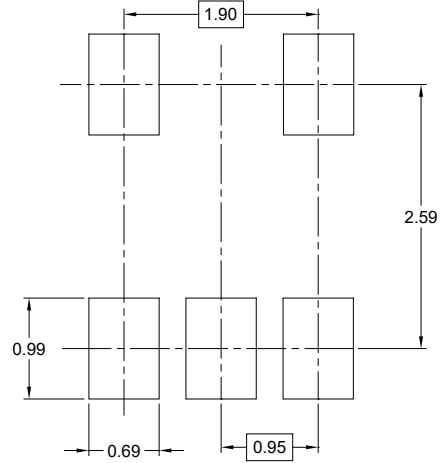
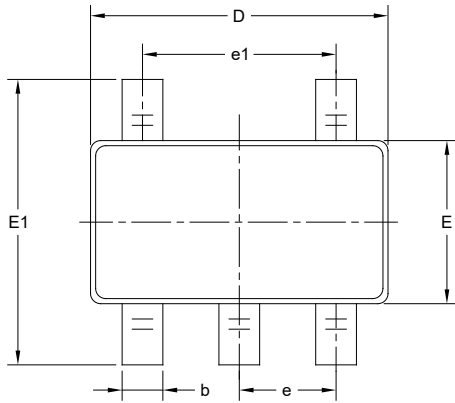

RECOMMENDED LAND PATTERN (Unit: mm)

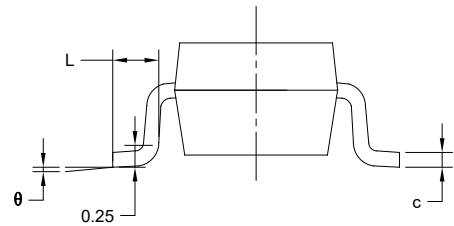
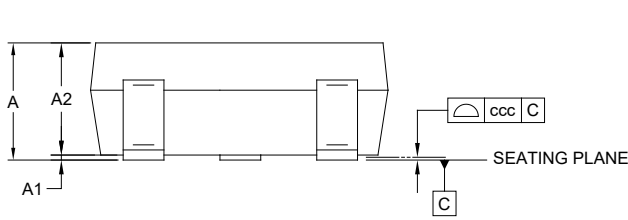

Symbol	Dimensions In Millimeters		
	MIN	MOD	MAX
A	-	-	1.450
A1	0.000	-	0.150
A2	0.900	-	1.300
b	0.300	-	0.500
c	0.080	-	0.220
D	2.750	-	3.050
E	1.450	-	1.750
E1	2.600	-	3.000
e	0.950 BSC		
e1	1.900 BSC		
L	0.300	-	0.600
θ	0°	-	8°
ccc	0.100		

NOTES:

1. This drawing is subject to change without notice.
2. The dimensions do not include mold flashes, protrusions or gate burrs.
3. Reference JEDEC MO-178.

PACKAGE INFORMATION

TAPE AND REEL INFORMATION

REEL DIMENSIONS

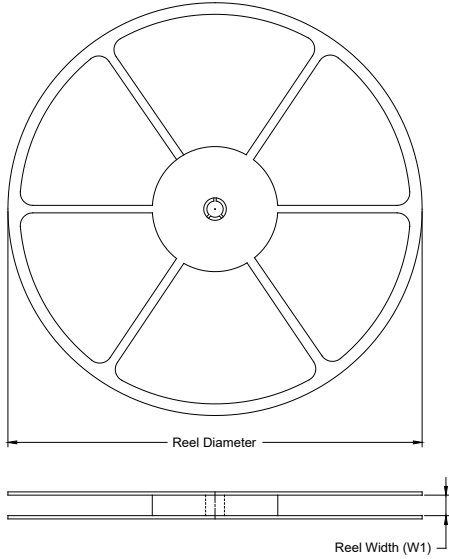

TAPE DIMENSIONS



NOTE: The picture is only for reference. Please make the object as the standard.

KEY PARAMETER LIST OF TAPE AND REEL

Package Type	Reel Diameter	Reel Width W1 (mm)	A0 (mm)	B0 (mm)	K0 (mm)	P0 (mm)	P1 (mm)	P2 (mm)	W (mm)	Pin1 Quadrant
SOT-23-5	7"	9.5	3.20	3.20	1.40	4.0	4.0	2.0	8.0	Q3

DD0001

PACKAGE INFORMATION

CARTON BOX DIMENSIONS



NOTE: The picture is only for reference. Please make the object as the standard.

KEY PARAMETER LIST OF CARTON BOX

Reel Type	Length (mm)	Width (mm)	Height (mm)	Pizza/Carton
7" (Option)	368	227	224	8
7"	442	410	224	18

DD0002