



SGM8610-2/SGM8610-4 8.5MHz, Low Noise, Rail-to-Rail I/O Operational Amplifiers

GENERAL DESCRIPTION

The SGM8610-2 (dual) and SGM8610-4 (quad) are low noise operational amplifiers. These devices are optimized for low voltage operation from 2.5V to 5.5V single supply or $\pm 1.25V$ to $\pm 2.75V$ dual power supplies. They have a 0.9mA typical quiescent current per amplifier. The SGM8610-2/4 support rail-to-rail input and output operation.

The SGM8610-2/4 are unity-gain stable and offer an 8.5MHz gain-bandwidth product and a $4.8V/\mu s$ slew rate. They also offer an ultra-low input bias current.

Furthermore, the SGM8610-2/4 feature high speed and low power. They are designed for a variety of applications, such as battery-powered equipment, portable equipment, sensor interfaces and active filters.

The SGM8610-2 is available in Green UTDFN-2 \times 2-8BL and SOIC-8 packages. The SGM8610-4 is available in Green SOIC-14 and TSSOP-14 packages. They are specified over the extended $-40^{\circ}C$ to $+125^{\circ}C$ temperature range.

FEATURES

- **Low Noise:** $30nV/\sqrt{Hz}$ at 1kHz
- **Low Input Offset Voltage:** $\pm 2mV$ (MAX)
- **Ultra-Low Input Bias Current:** $\pm 5pA$ (TYP)
- **Unity-Gain Stable**
- **Gain-Bandwidth Product:** 8.5MHz
- **High Output Current:** 32mA (TYP)
- **Rail-to-Rail Input and Output**
- **Supply Voltage Range:** 2.5V to 5.5V
- **Low Quiescent Current:** 0.9mA/Amplifier (TYP)
- **$-40^{\circ}C$ to $+125^{\circ}C$ Operating Temperature Range**
- **Small Packaging:**
 - SGM8610-2 Available in Green UTDFN-2 \times 2-8BL and SOIC-8 Packages
 - SGM8610-4 Available in Green SOIC-14 and TSSOP-14 Packages

APPLICATIONS

Battery-Powered Equipment
Portable Equipment
Active Filter
Medical Equipment
Signal Conditioning

PACKAGE/ORDERING INFORMATION

MODEL	PACKAGE DESCRIPTION	SPECIFIED TEMPERATURE RANGE	ORDERING NUMBER	PACKAGE MARKING	PACKING OPTION
SGM8610-2	UTDFN-2×2-8BL	-40°C to +125°C	SGM8610-2XUGD8G/TR	09F XXXX	Tape and Reel, 3000
	SOIC-8	-40°C to +125°C	SGM8610-2XS8G/TR	0J5XS8 XXXXX	Tape and Reel, 4000
SGM8610-4	SOIC-14	-40°C to +125°C	SGM8610-4XS14G/TR	SGM86104XS14 XXXXX	Tape and Reel, 2500
	TSSOP-14	-40°C to +125°C	SGM8610-4XTS14G/TR	SGM86104 XTS14 XXXXX	Tape and Reel, 4000

MARKING INFORMATION

NOTE: XXXX = Date Code, Trace Code and Vendor Code. XXXXX = Date Code, Trace Code and Vendor Code.

UTDFN-2×2-8BL

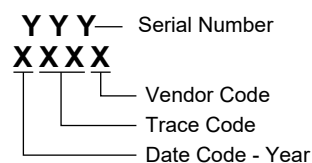

SOIC-8/SOIC-14/TSSOP-14

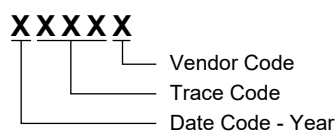

Green (RoHS & HSF): SG Micro Corp defines "Green" to mean Pb-Free (RoHS compatible) and free of halogen substances. If you have additional comments or questions, please contact your SGMICRO representative directly.

ABSOLUTE MAXIMUM RATINGS

Supply Voltage, +V _S to -V _S	6V
Differential Input Voltage, V _{ID}	±V _S
Input Voltage Range, V _{IN}	(-V _S) - 0.3V to (+V _S) + 0.3V
Package Thermal Resistance	
UTDFN-2×2-8BL, θ _{JA}	82°C/W
SOIC-8, θ _{JA}	151°C/W
SOIC-14, θ _{JA}	123.2°C/W
TSSOP-14, θ _{JA}	151.6°C/W
Junction Temperature.....	+150°C
Storage Temperature Range.....	-65°C to +150°C
Lead Temperature (Soldering, 10s).....	+260°C
ESD Susceptibility ⁽¹⁾⁽²⁾	
HBM.....	±5000V
CDM.....	±1000V

NOTES:

1. For human body model (HBM), all pins comply with ANSI/ESDA/JEDEC JS-001 specifications.
2. For charged device model (CDM), all pins comply with ANSI/ESDA/JEDEC JS-002 specifications.

RECOMMENDED OPERATING CONDITIONS

Supply Voltage Range.....	2.5V to 5.5V
Operating Temperature Range.....	-40°C to +125°C

OVERSTRESS CAUTION

Stresses beyond those listed in Absolute Maximum Ratings may cause permanent damage to the device. Exposure to absolute maximum rating conditions for extended periods may affect reliability. Functional operation of the device at any conditions beyond those indicated in the Recommended Operating Conditions section is not implied.

ESD SENSITIVITY CAUTION

This integrated circuit can be damaged if ESD protections are not considered carefully. SGMICRO recommends that all integrated circuits be handled with appropriate precautions. Failure to observe proper handling and installation procedures can cause damage. ESD damage can range from subtle performance degradation to complete device failure. Precision integrated circuits may be more susceptible to damage because even small parametric changes could cause the device not to meet the published specifications.

DISCLAIMER

SG Micro Corp reserves the right to make any change in circuit design, or specifications without prior notice.

PIN CONFIGURATIONS

SGM8610-2 (TOP VIEW)

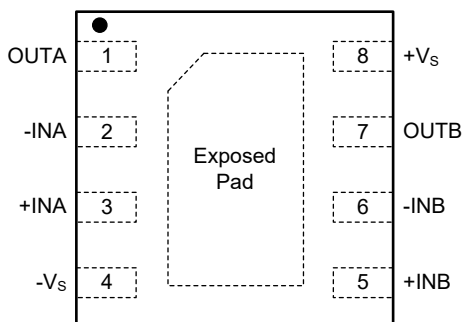

UTDFN-2x2-8BL

SGM8610-2 (TOP VIEW)

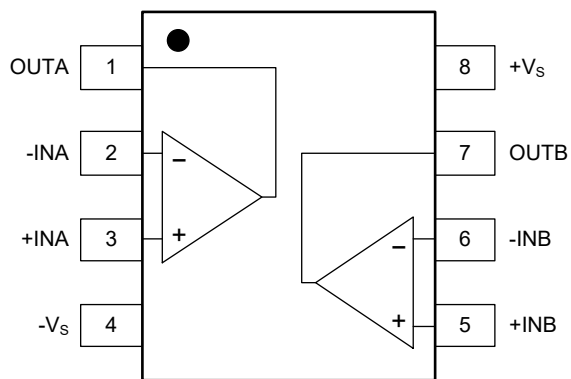

SOIC-8

SGM8610-4 (TOP VIEW)

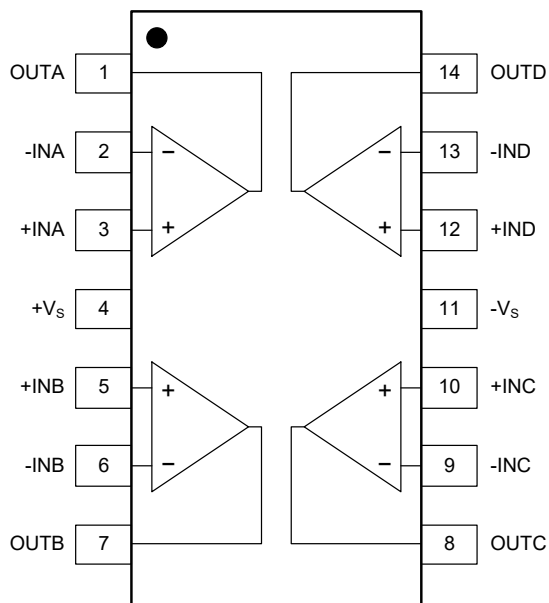

SOIC-14/TSSOP-14

ELECTRICAL CHARACTERISTICS

($V_S = 2.5V$ to $5.5V$, $V_{CM} = V_S/2$, and R_L connected to $V_S/2$, Full = $-40^\circ C$ to $+125^\circ C$, typical values are at $T_A = +25^\circ C$, unless otherwise noted.)

PARAMETER	SYMBOL	CONDITIONS	TEMP	MIN	TYP	MAX	UNITS
Input Characteristics							
Input Offset Voltage	V_{OS}		+25°C	-1.7		1.7	mV
			Full	-2		2	
Input Offset Voltage Drift	$\Delta V_{OS}/\Delta T$		Full		1.2		$\mu V/^\circ C$
Input Offset Current	I_{OS}		+25°C		± 5	± 120	pA
			Full			± 6000	
Input Bias Current	I_B		+25°C		± 5	± 120	pA
			Full			± 6000	
Input Common Mode Voltage Range	V_{CM}		Full	$(-V_S) - 0.1$		$(+V_S) + 0.1$	V
Common Mode Rejection Ratio	CMRR	$V_S = 0V$ to $5.5V$, $-0.1V < V_{CM} < (+V_S) + 0.1V$	+25°C	58	71		dB
			Full	55			
		$V_S = 0V$ to $5.5V$, $-0.1V < V_{CM} < (+V_S) - 1.4V$	+25°C	69	84		
			Full	66			
Large-Signal Voltage Gain	A_V	$R_L = 10k\Omega$, $V_{OUT} = 0.5V$ to $(+V_S) - 0.5V$	+25°C	89	116		dB
			Full	86			
Output Characteristics							
High-Level Output Voltage	$V_S - V_{OH}$	$R_L = 10k\Omega$	+25°C		7	15	mV
			Full			20	
		$R_L = 600\Omega$	+25°C		64	85	
			Full			110	
Low-Level Output Voltage	V_{OL}	$R_L = 10k\Omega$	+25°C		4	15	mV
			Full			20	
		$R_L = 600\Omega$	+25°C		57	80	
			Full			105	
Output Short-Circuit Current	I_{SINK}	$V_{OUT} = V_S$	+25°C	30	44		mA
			Full	20			
	I_{SOURCE}	$V_{OUT} = 0V$	+25°C	21	32		
			Full	12			

ELECTRICAL CHARACTERISTICS (continued)

($V_S = 2.5V$ to $5.5V$, $V_{CM} = V_S/2$, and R_L connected to $V_S/2$, Full = $-40^\circ C$ to $+125^\circ C$, typical values are at $T_A = +25^\circ C$, unless otherwise noted.)

PARAMETER	SYMBOL	CONDITIONS	TEMP	MIN	TYP	MAX	UNITS
Power Supply							
Operating Voltage Range	V_S		Full	2.5		5.5	V
Power Supply Rejection Ratio	PSRR		+25°C	85	100		dB
			Full	82			
Quiescent Current/Amplifier	I_Q	$I_{OUT} = 0A$	+25°C		0.9	1.25	mA
			Full			1.5	
Dynamic Performance							
Gain-Bandwidth Product	GBP	$R_L = 2k\Omega$, $C_L = 100pF$	+25°C		8.5		MHz
Unity-Gain Frequency		$R_L = 2k\Omega$, $C_L = 100pF$	+25°C		8.5		MHz
Phase Margin	ϕ_O	$R_L = 2k\Omega$, $C_L = 100pF$	+25°C		55		°
Gain Margin	G_M	$R_L = 2k\Omega$, $C_L = 100pF$	+25°C		13		dB
Slew Rate	SR	$V_{IN} = (-V_S) + 0.5V$ to $(+V_S) - 0.5V$, $G = +1$, $R_L = 2k\Omega$, $C_L = 100pF$	+25°C		4.8		V/ μs
Settling Time to 0.1%	t_s	$G = -1$, 2V output step	+25°C		0.7		μs
Overload Recovery Time	ORT	$V_{IN} \times G > V_S$	+25°C		0.4		μs
Total Harmonic Distortion + Noise	THD+N	$G = +1$, $f = 1kHz$, $R_L = 2k\Omega$, $BW = 22kHz$, $V_{OUT} = [(+V_S) - 1.6V]V_{P-P}$, $V_{CM} = [(+V_S) - 1.2V]/2$	+25°C		0.0014		%
Noise							
Input Voltage Noise Density	e_n	$f = 1kHz$	+25°C		30		nV/ \sqrt{Hz}
		$f = 10kHz$	+25°C		15		

TYPICAL PERFORMANCE CHARACTERISTICS

At $T_A = +25^\circ\text{C}$, $V_S = 5.5\text{V}$, unless otherwise noted.

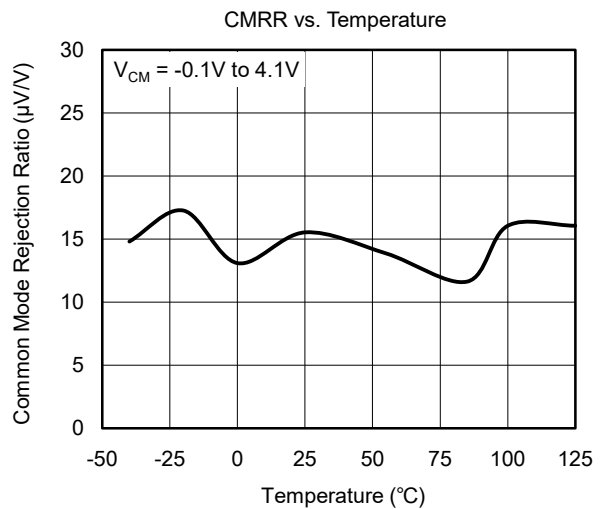
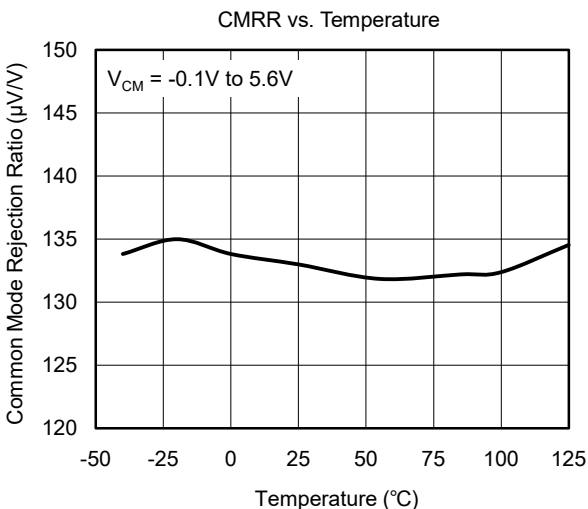
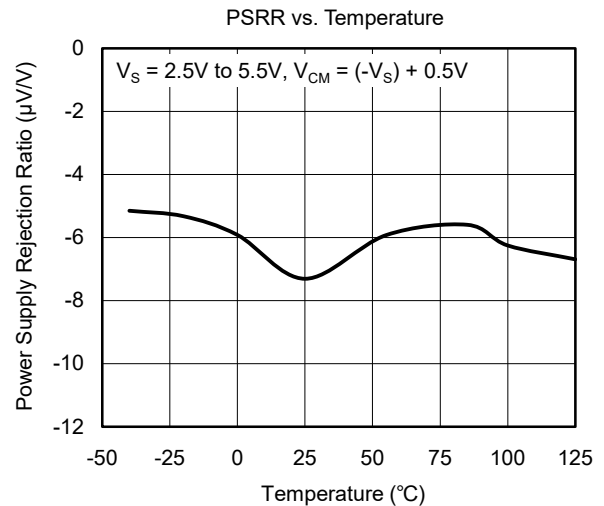
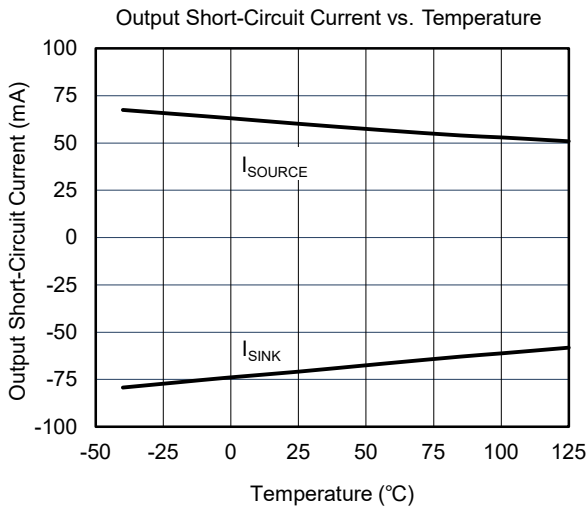
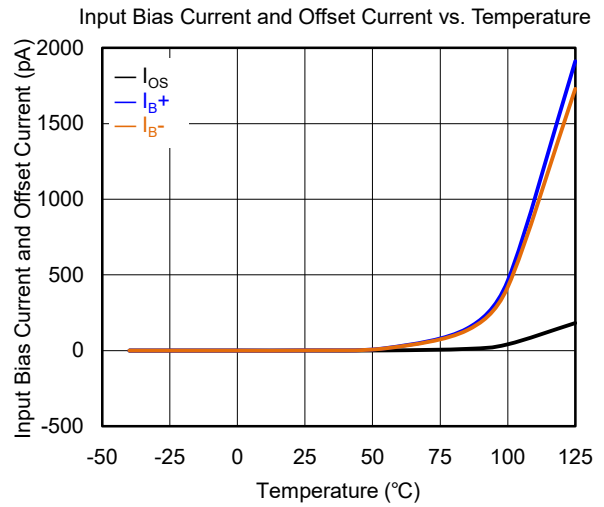
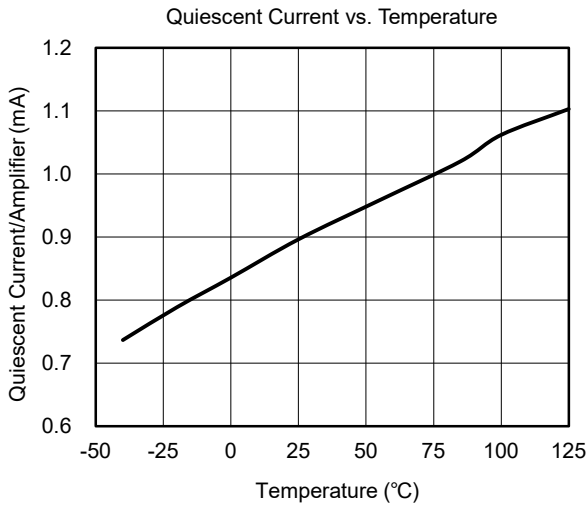

TYPICAL PERFORMANCE CHARACTERISTICS (continued)

At $T_A = +25^\circ\text{C}$, $V_S = 5.5\text{V}$, unless otherwise noted.

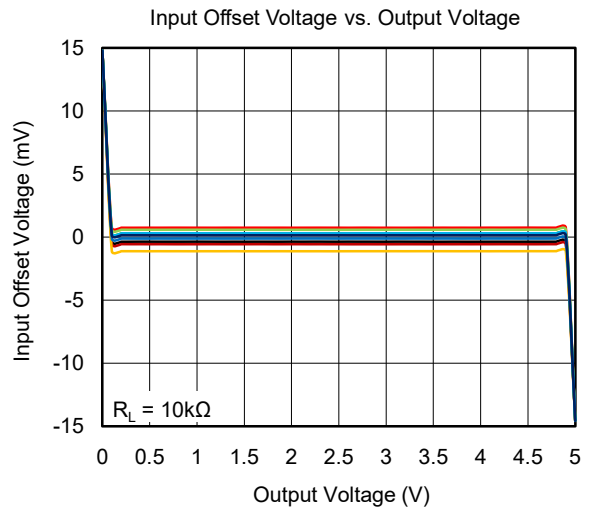
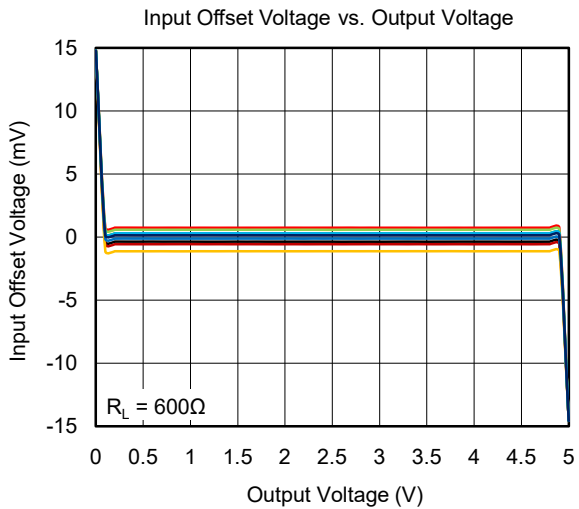
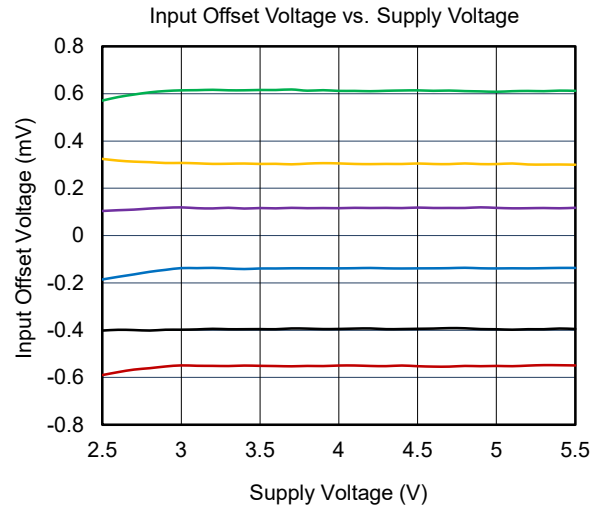
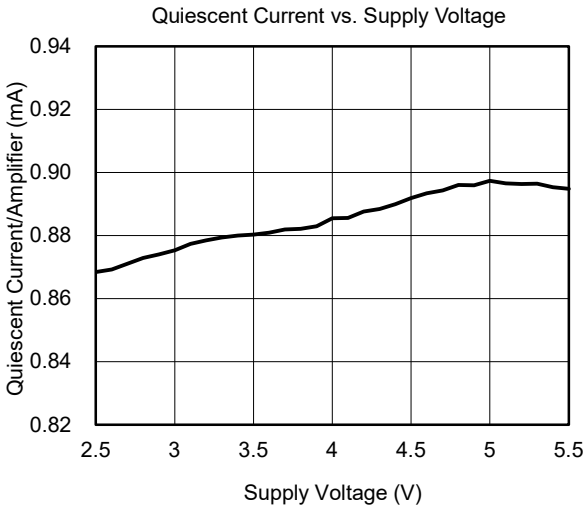
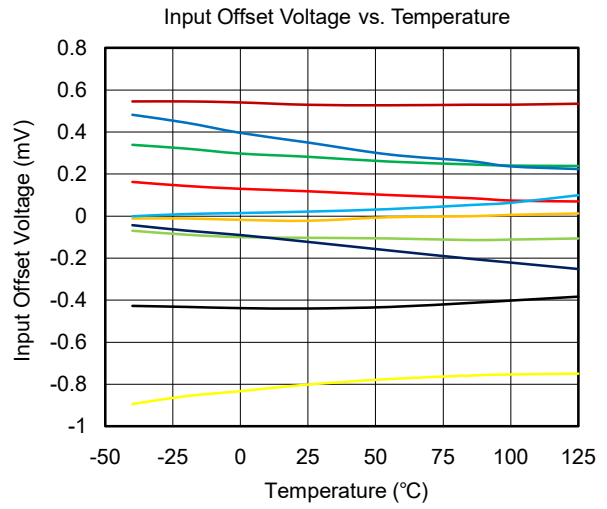
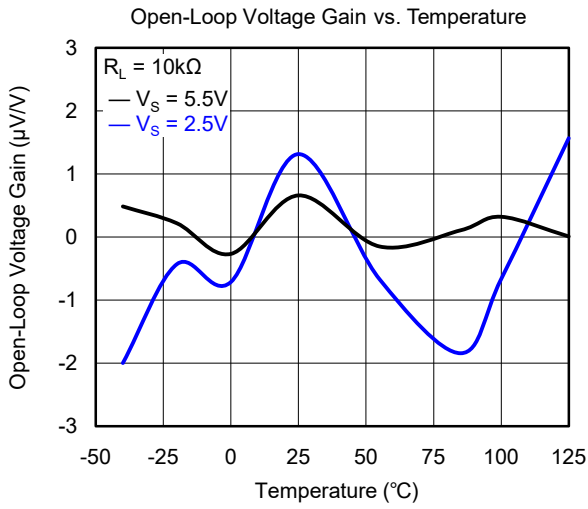

TYPICAL PERFORMANCE CHARACTERISTICS (continued)

At $T_A = +25^\circ\text{C}$, $V_S = 5.5\text{V}$, unless otherwise noted.

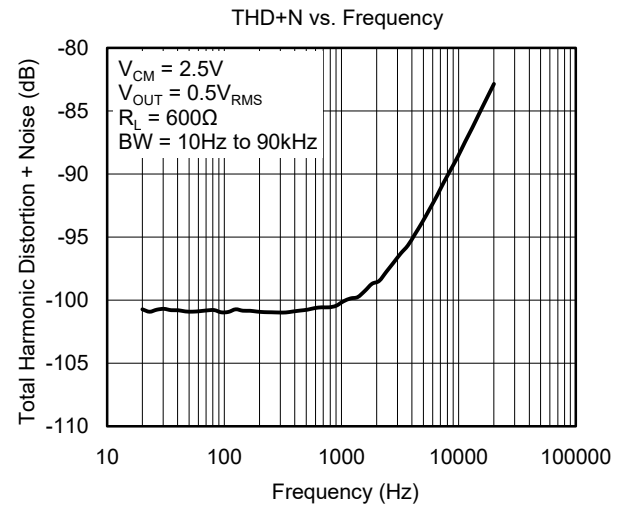
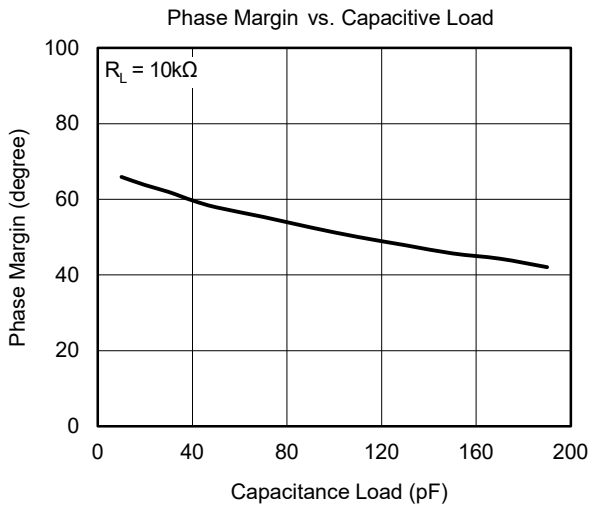
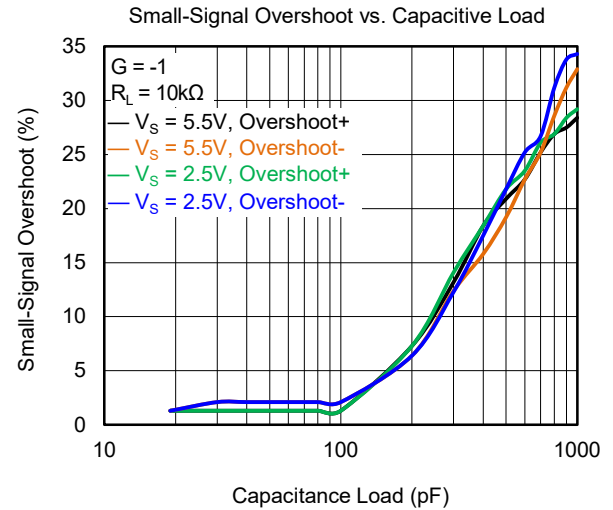
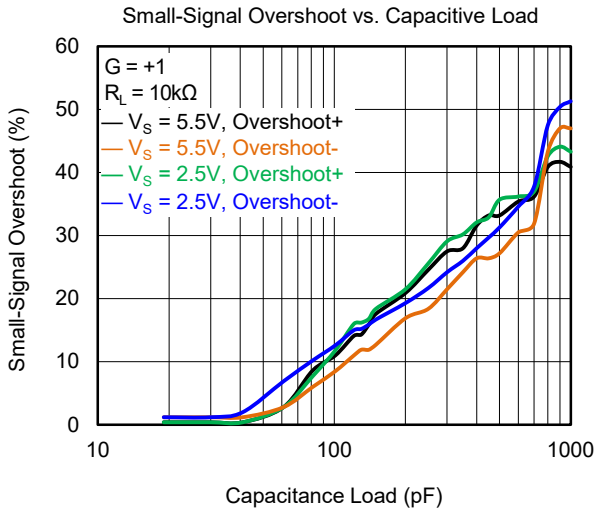
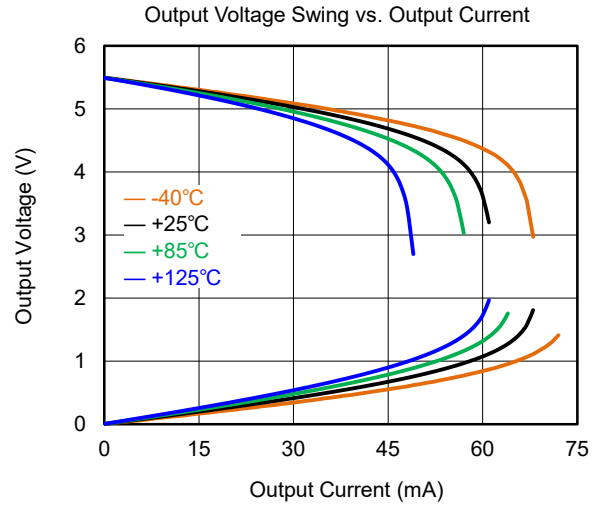
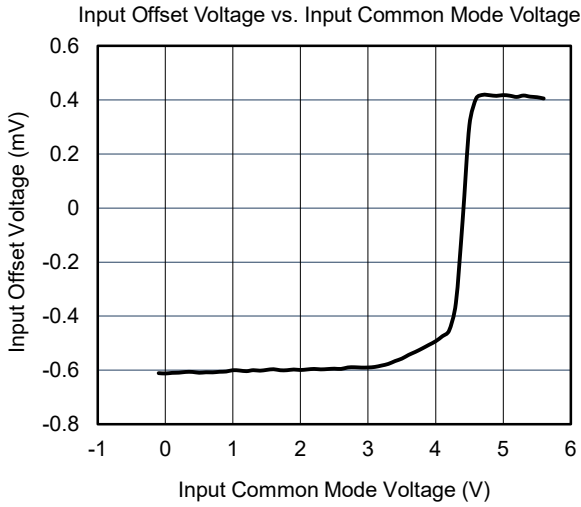

TYPICAL PERFORMANCE CHARACTERISTICS (continued)

At $T_A = +25^\circ\text{C}$, $V_S = 5.5\text{V}$, unless otherwise noted.

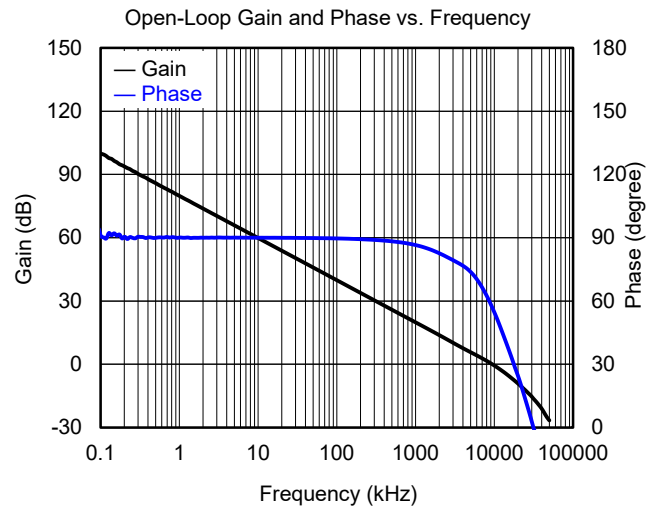
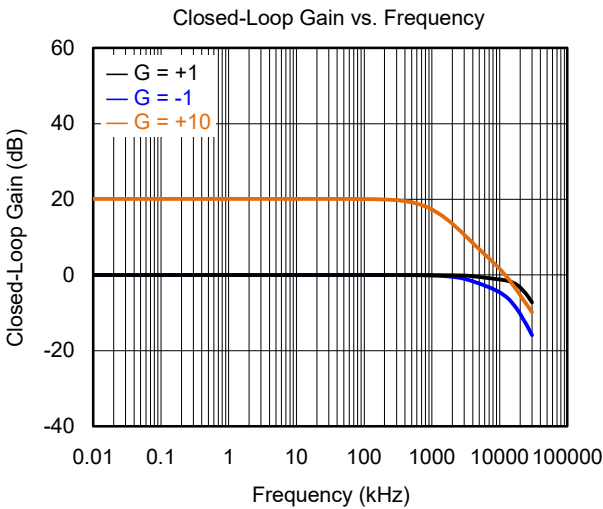
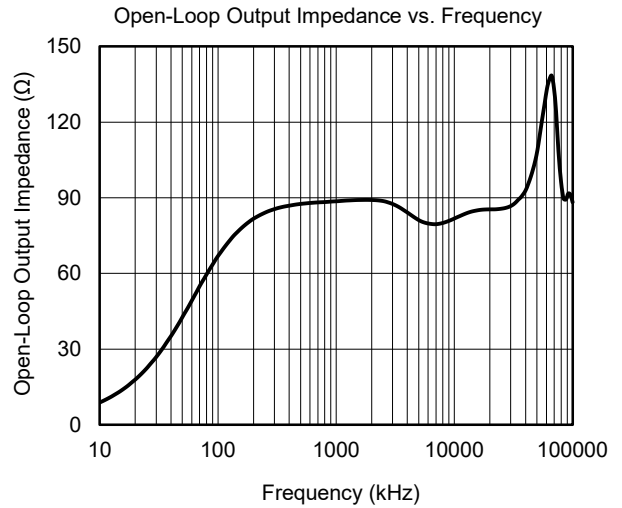
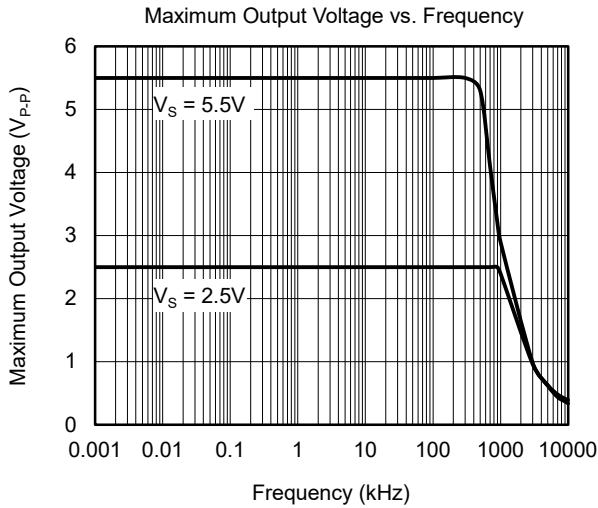
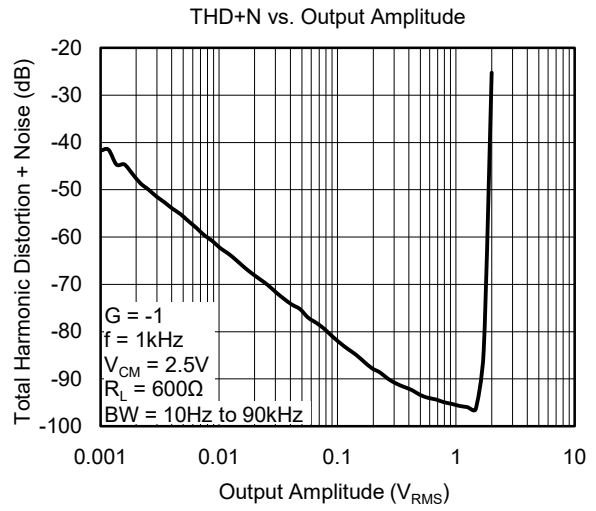
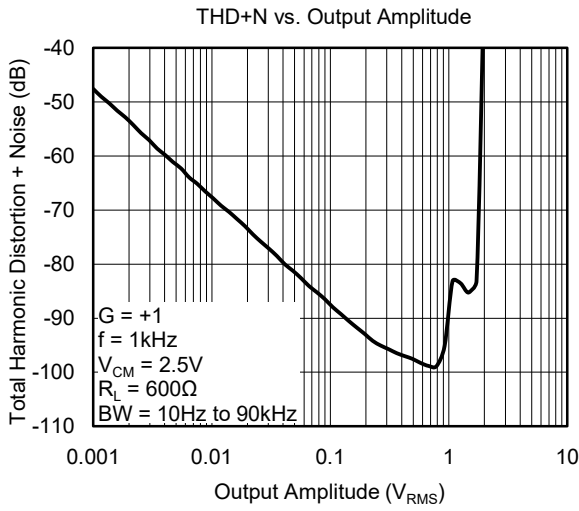

TYPICAL PERFORMANCE CHARACTERISTICS (continued)

At $T_A = +25^\circ\text{C}$, $V_S = 5.5\text{V}$, unless otherwise noted.

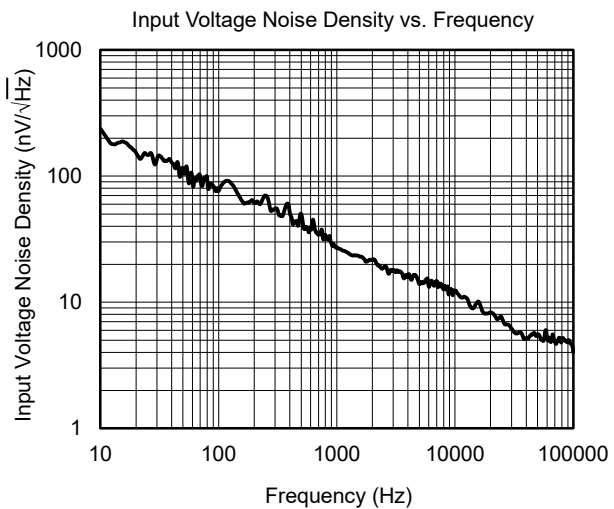
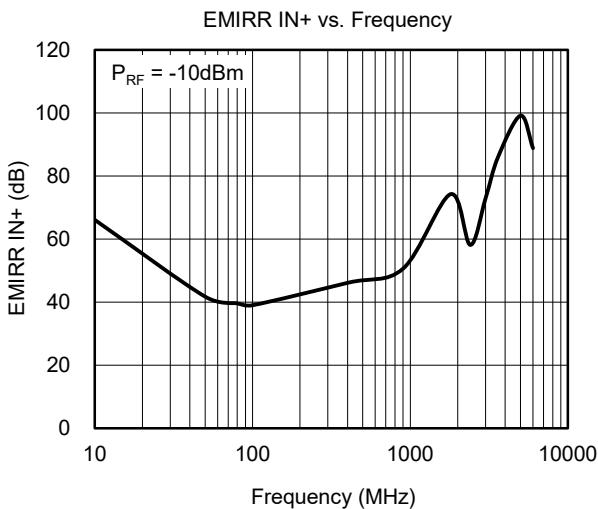
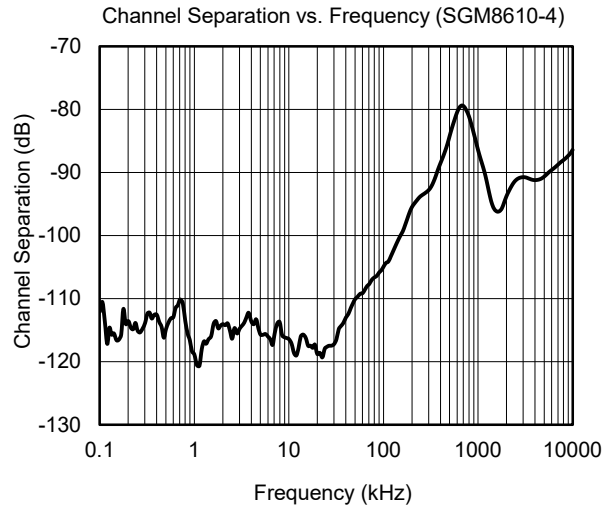
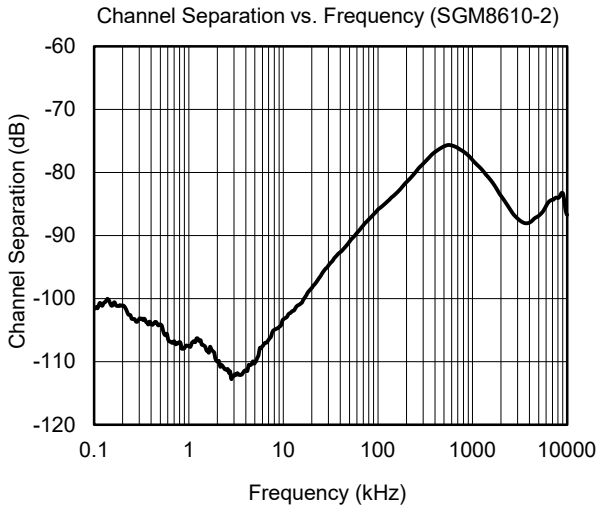
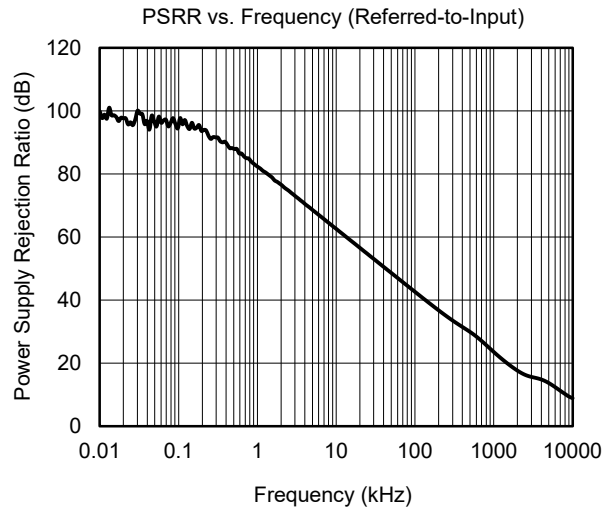
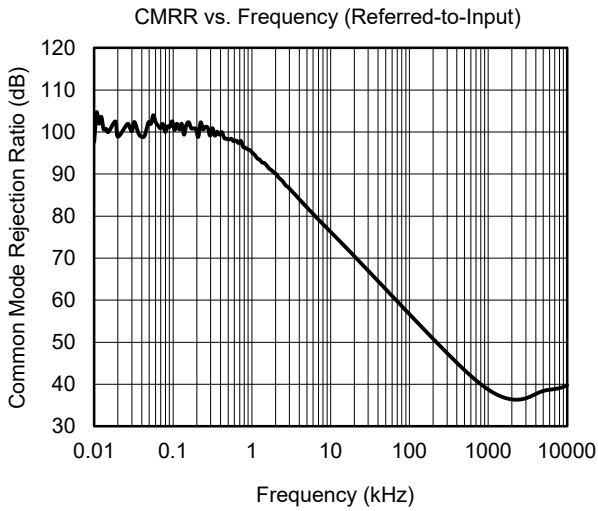

TYPICAL PERFORMANCE CHARACTERISTICS (continued)

At $T_A = +25^\circ\text{C}$, $V_S = 5.5\text{V}$, unless otherwise noted.

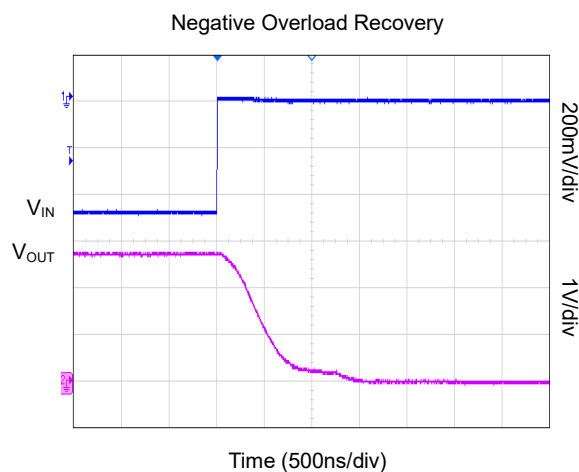
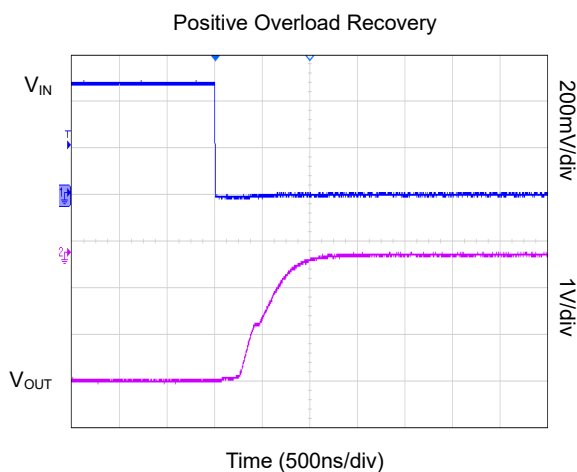
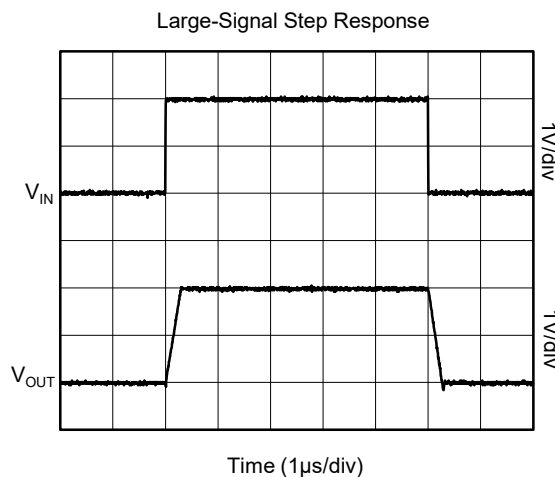
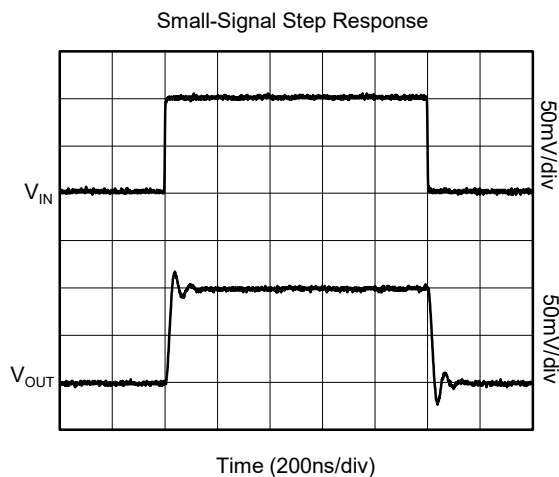
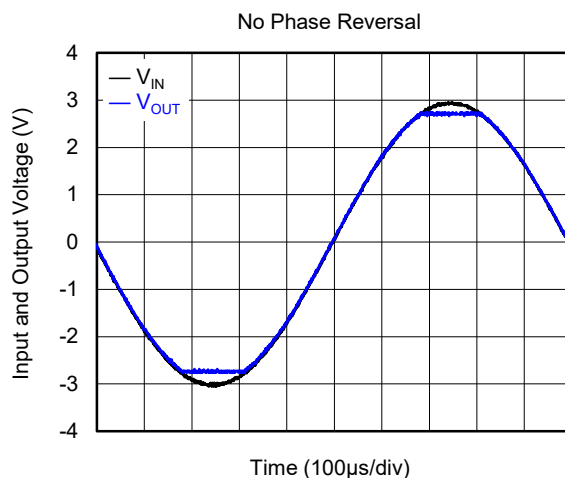
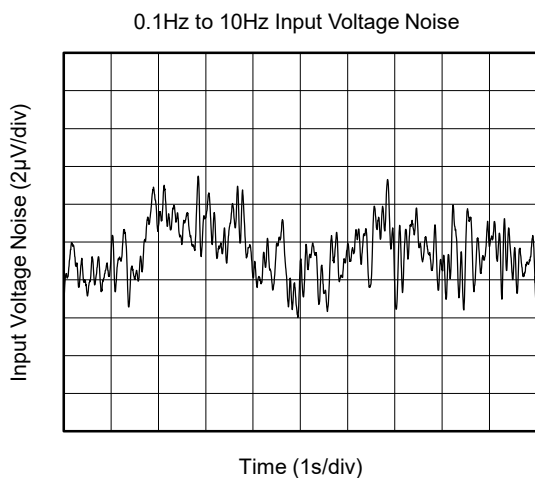

TYPICAL PERFORMANCE CHARACTERISTICS (continued)

At $T_A = +25^\circ\text{C}$, $V_S = 5.5\text{V}$, unless otherwise noted.

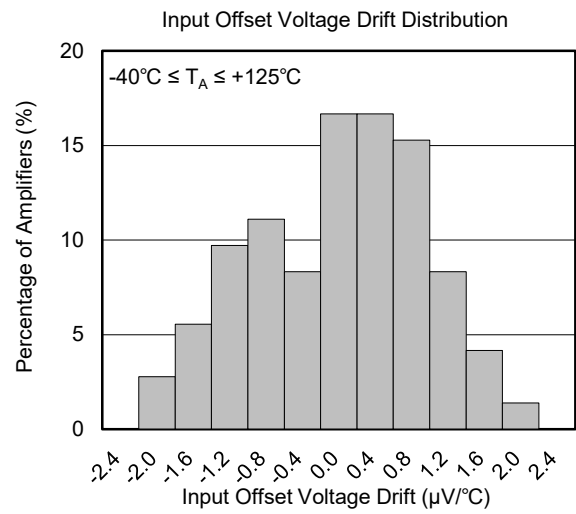
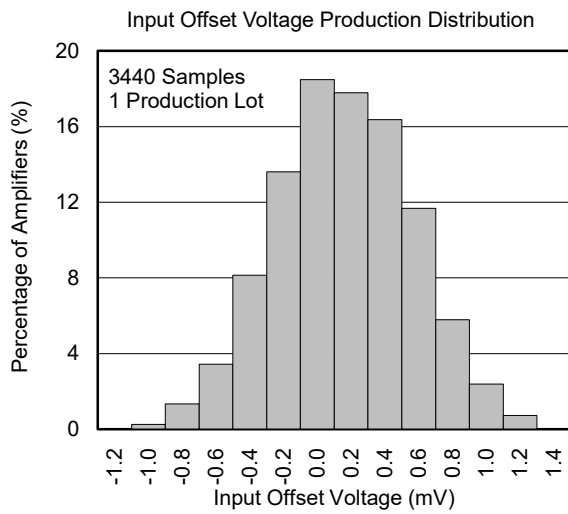

APPLICATION INFORMATION

Rail-to-Rail Input

When SGM8610-2/4 work at the power supply between 2.5V and 5.5V, the input common mode voltage range is from $(-V_S) - 0.1V$ to $(+V_S) + 0.1V$. In Figure 1, the ESD diodes between the inputs and the power supply rails will clamp the input voltage so that it does not exceed the rails.

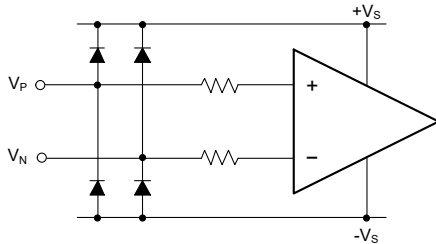

Figure 1. Input Equivalent Circuit

Input Current-Limit Protection

For ESD diode clamping protection, when the current flowing through ESD diode exceeds the maximum rating value, the ESD diode and amplifier will be damaged, so current-limit protection will be added in some applications. One resistor is selected to limit the current not to exceed the maximum rating value. In Figure 2, a series input resistor is used to limit the input current to less than 10mA, but the drawback of this current-limit resistor is that it contributes thermal noise at the amplifier input. If this resistor must be added, its value must be selected as small as possible.

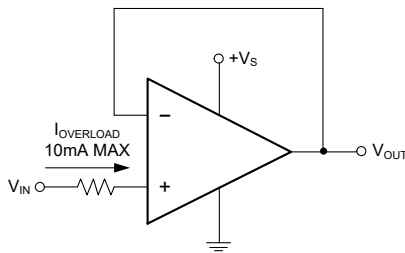

Figure 2. Input Current-Limit Protection

Rail-to-Rail Output

The SGM8610-2/4 support rail-to-rail output operation. In single power supply application, for example, when $+V_S = 5.5V$, $-V_S = GND$, 10kΩ load resistor is tied from OUT pin to $V_S/2$, the typical output swing range is from 0.004V to 5.493V.

Driving Capacitive Loads

The SGM8610-2/4 are designed for driving the 1000pF capacitive load with unity-gain stable. If greater capacitive load must be driven in application, the circuit in Figure 3 can be used. In this circuit, the IR drop voltage generated by R_{ISO} is compensated by feedback loop.

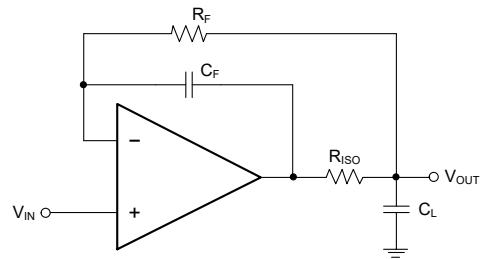

Figure 3. Circuit to Drive Heavy Capacitive Load

Power Supply Decoupling and Layout

A clean and low noise power supply is very important in amplifier circuit design. Besides of input signal noise, the power supply is one of important source of noise to the amplifiers through $+V_S$ and $-V_S$ pins. Power supply bypassing is an effective method to clear up the noise at power supply, and the low impedance path to ground of decoupling capacitor will bypass the noise to GND. In application, 10μF ceramic capacitor paralleled with 0.1μF or 0.01μF ceramic capacitor is used in Figure 4. The ceramic capacitors should be placed as close as possible to $+V_S$ and $-V_S$ power supply pins.

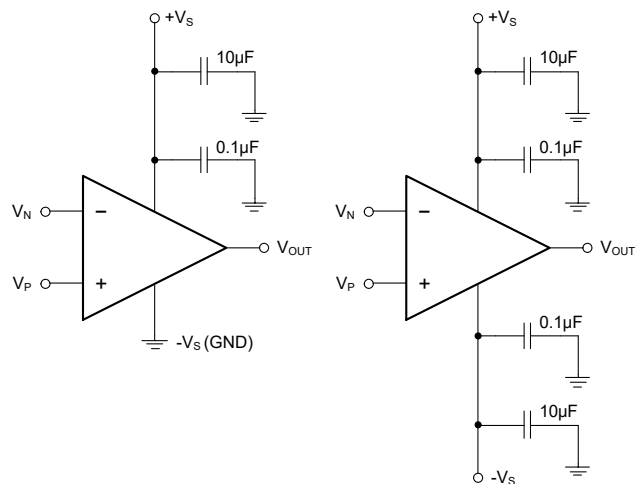

Figure 4. Amplifier Power Supply Bypassing

APPLICATION INFORMATION (continued)

Grounding

In low speed application, one node grounding technique is the simplest and most effective method to eliminate the noise generated by grounding. In high speed application, the general method to eliminate noise is to use a complete ground plane technique, and the whole ground plane will help distribute heat and reduce EMI noise pickup.

Reduce Input-to-Output Coupling

To reduce the input-to-output coupling, the input traces must be placed as far away from the power supply or output traces as possible. The sensitive trace must not be placed in parallel with the noisy trace in the same layer. They must be placed perpendicularly in different layers to reduce the crosstalk. These PCB layout techniques will help to reduce unwanted positive feedback and noise.

Typical Application Circuits

Difference Amplifier

The circuit in Figure 5 is a design example of classical difference amplifier. If $R_4/R_3 = R_2/R_1$, then $V_{OUT} = (V_P - V_N) \times R_2/R_1 + V_{REF}$.

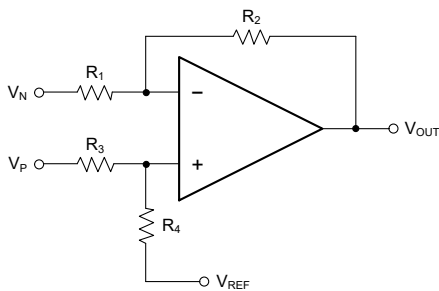

Figure 5. Difference Amplifier

High Input Impedance Difference Amplifier

The circuit in Figure 6 is a design example of high input impedance difference amplifier. The added amplifiers at

the input are used to increase the input impedance and eliminate drawback of low input impedance in Figure 5.

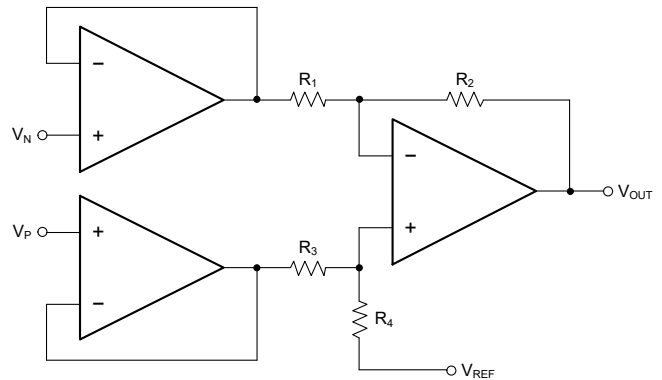

Figure 6. High Input Impedance Difference Amplifier

Active Low-Pass Filter

The circuit in Figure 7 is a design example of active low-pass filter, the DC gain is equal to $-R_2/R_1$ and the -3dB corner frequency is equal to $1/(2\pi R_2 C)$. In this design, the filter bandwidth must be less than the bandwidth of the amplifier, and the resistor values must be selected as low as possible to reduce ringing or oscillation generated by the parasitic parameters in PCB layout.

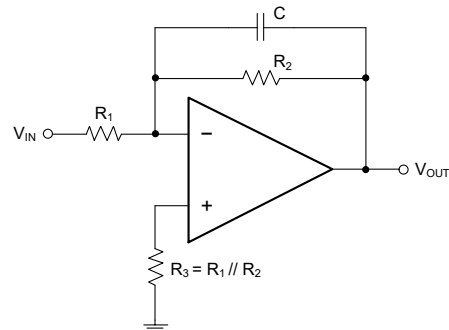

Figure 7. Active Low-Pass Filter

REVISION HISTORY

NOTE: Page numbers for previous revisions may differ from page numbers in the current version.

FEBRUARY 2025 – REV.A.1 to REV.A.2	Page
Updated Package/Ordering Information section	2

FEBRUARY 2025 – REV.A to REV.A.1	Page
Added SGM8610-4.....	All
Updated Electrical Characteristics section	4, 5
Updated Typical Performance Characteristics section	10, 11

Changes from Original (NOVEMBER 2023) to REV.A	Page
Changed from product preview to production data.....	All

PACKAGE OUTLINE DIMENSIONS

UTDFN-2x2-8BL

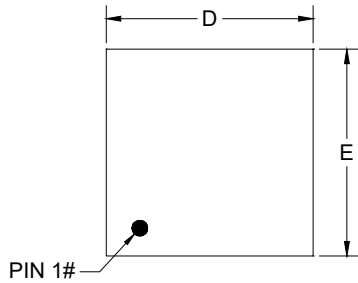

TOP VIEW

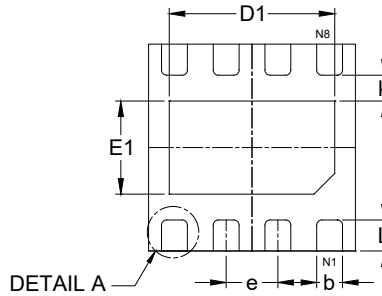

BOTTOM VIEW

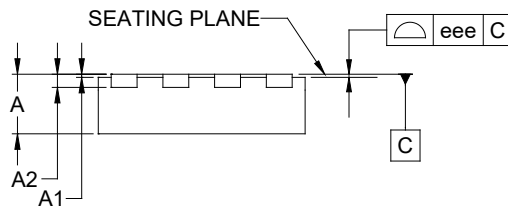

SIDE VIEW

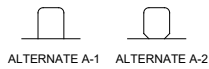

DETAIL A
ALTERNATE TERMINAL
CONSTRUCTION

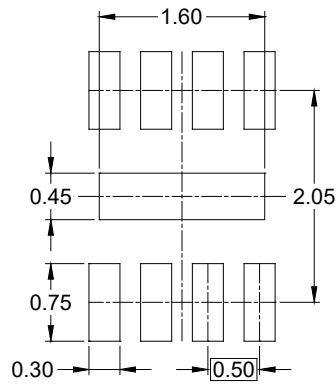

RECOMMENDED LAND PATTERN (Unit: mm)

Symbol	Dimensions In Millimeters		
	MIN	NOM	MAX
A	0.500	-	0.600
A1	0.000	-	0.050
A2	0.127 REF		
b	0.200	-	0.300
D	1.900	-	2.100
E	1.900	-	2.100
D1	1.500	1.600	1.700
E1	0.800	0.900	1.000
e	0.500 BSC		
k	0.250 REF		
L	0.200	-	0.400
eee	0.050		

NOTE: This drawing is subject to change without notice.

PACKAGE OUTLINE DIMENSIONS

SOIC-8

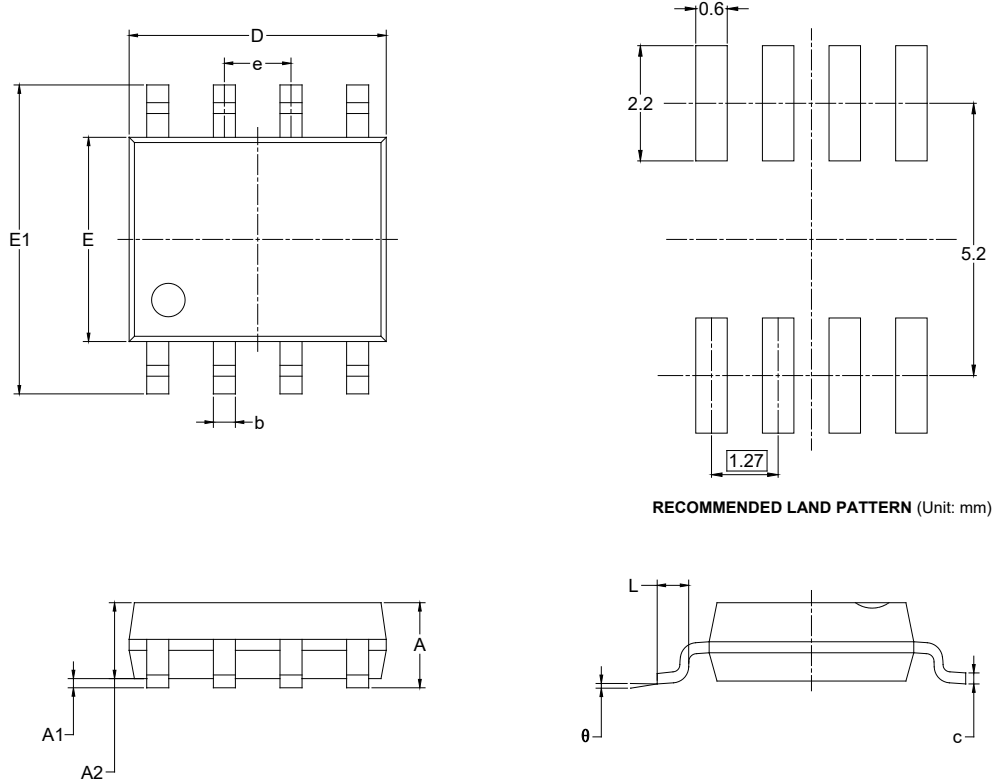

RECOMMENDED LAND PATTERN (Unit: mm)

Symbol	Dimensions In Millimeters		Dimensions In Inches	
	MIN	MAX	MIN	MAX
A	1.350	1.750	0.053	0.069
A1	0.100	0.250	0.004	0.010
A2	1.350	1.550	0.053	0.061
b	0.330	0.510	0.013	0.020
c	0.170	0.250	0.006	0.010
D	4.700	5.100	0.185	0.200
E	3.800	4.000	0.150	0.157
E1	5.800	6.200	0.228	0.244
e	1.27 BSC		0.050 BSC	
L	0.400	1.270	0.016	0.050
θ	0°	8°	0°	8°

- NOTES:
 1. Body dimensions do not include mode flash or protrusion.
 2. This drawing is subject to change without notice.

PACKAGE INFORMATION

PACKAGE OUTLINE DIMENSIONS

SOIC-14

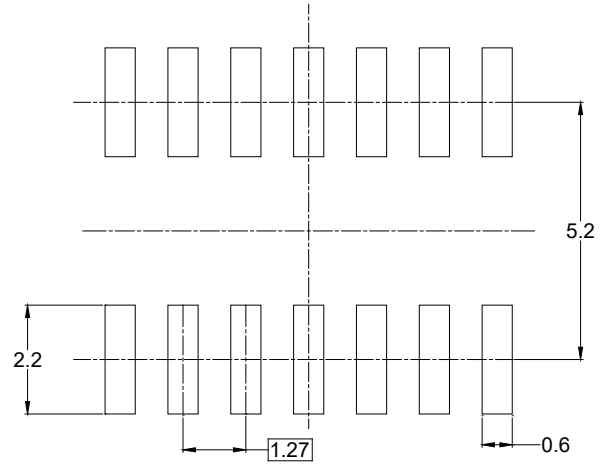
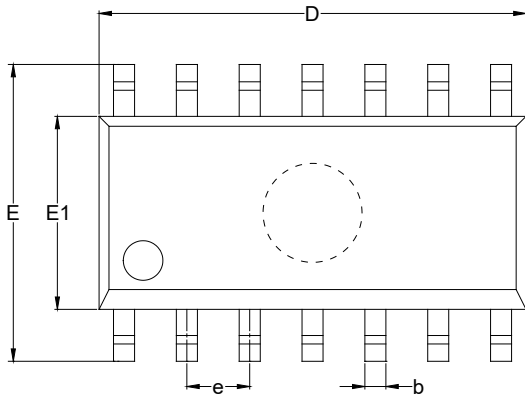

RECOMMENDED LAND PATTERN (Unit: mm)

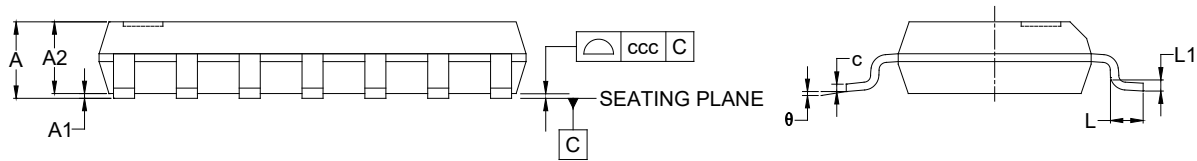

Symbol	Dimensions In Millimeters		
	MIN	NOM	MAX
A	-	-	1.750
A1	0.100	-	0.250
A2	1.250	-	-
b	0.310	-	0.510
c	0.100	-	0.250
D	8.450	-	8.850
E	5.800	-	6.200
E1	3.800	-	4.000
e	1.270 BSC		
L	0.400	-	1.270
L1	0.250 TYP		
θ	0°	-	8°
ccc	0.100		

NOTES:

1. This drawing is subject to change without notice.
2. The dimensions do not include mold flashes, protrusions or gate burrs.
3. Reference JEDEC MS-012.

PACKAGE OUTLINE DIMENSIONS

TSSOP-14

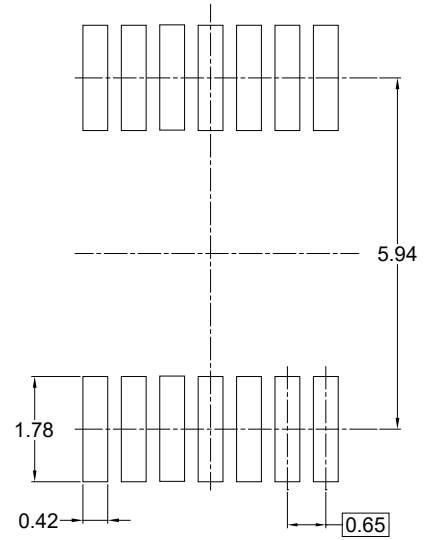
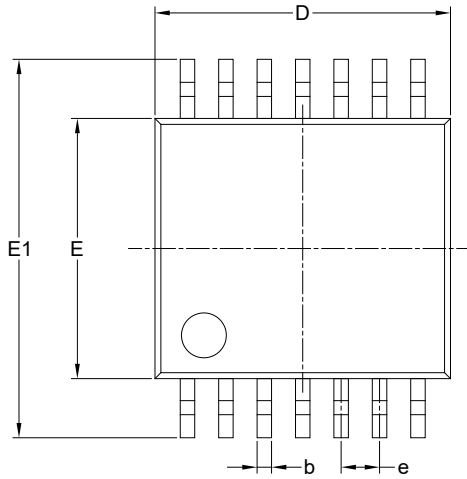

RECOMMENDED LAND PATTERN (Unit: mm)

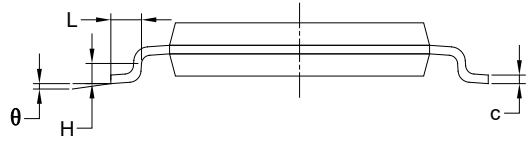
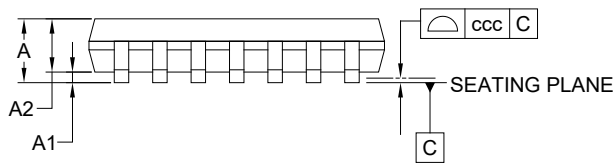

Symbol	Dimensions In Millimeters		
	MIN	NOM	MAX
A	-	-	1.200
A1	0.050	-	0.150
A2	0.800	-	1.050
b	0.190	-	0.300
c	0.090	-	0.200
D	4.860	-	5.100
E	4.300	-	4.500
E1	6.200	-	6.600
e	0.650 BSC		
L	0.450	-	0.750
H	0.250 TYP		
θ	0°	-	8°
ccc	0.100		

NOTES:

1. This drawing is subject to change without notice.
2. The dimensions do not include mold flashes, protrusions or gate burrs.
3. Reference JEDEC MO-153.

PACKAGE INFORMATION

TAPE AND REEL INFORMATION

REEL DIMENSIONS

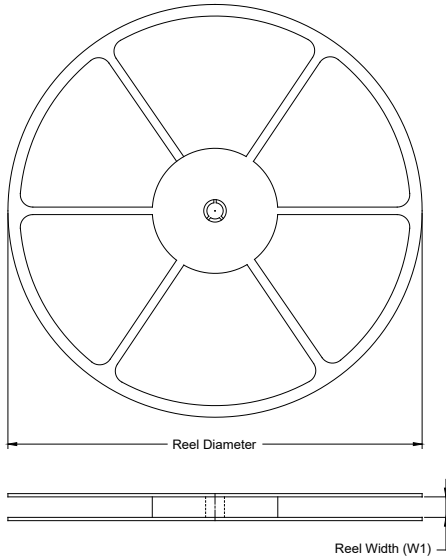

TAPE DIMENSIONS

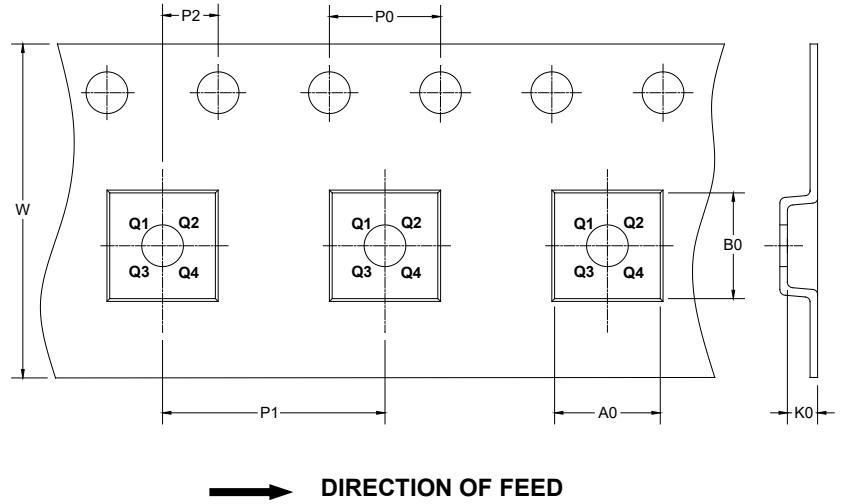

NOTE: The picture is only for reference. Please make the object as the standard.

KEY PARAMETER LIST OF TAPE AND REEL

Package Type	Reel Diameter	Reel Width W1 (mm)	A0 (mm)	B0 (mm)	K0 (mm)	P0 (mm)	P1 (mm)	P2 (mm)	W (mm)	Pin1 Quadrant
UTDFN-2x2-8BL	7"	9.5	2.25	2.25	0.75	4.0	4.0	2.0	8.0	Q2
SOIC-8	13"	12.4	6.40	5.40	2.10	4.0	8.0	2.0	12.0	Q1
SOIC-14	13"	16.4	6.60	9.30	2.10	4.0	8.0	2.0	16.0	Q1
TSSOP-14	13"	12.4	6.80	5.40	1.50	4.0	8.0	2.0	12.0	Q1

000001

PACKAGE INFORMATION

CARTON BOX DIMENSIONS

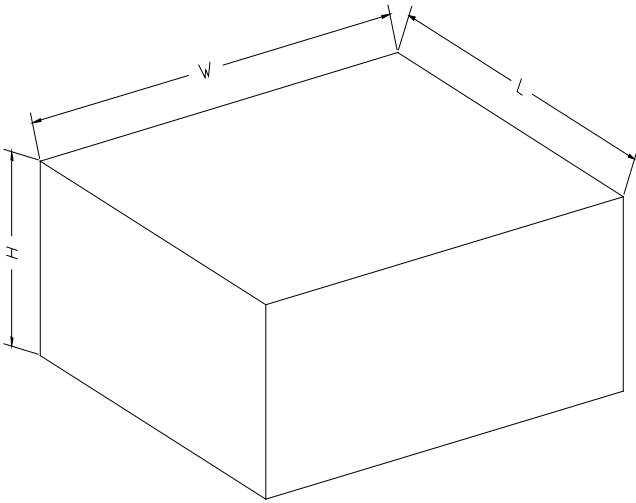

NOTE: The picture is only for reference. Please make the object as the standard.

KEY PARAMETER LIST OF CARTON BOX

Reel Type	Length (mm)	Width (mm)	Height (mm)	Pizza/Carton
7" (Option)	368	227	224	8
7"	442	410	224	18
13"	386	280	370	5

DD0002