



SGM8277-1/SGM8277-2

4MHz, Rail-to-Rail Output, Low Noise, High Voltage, Precision Operational Amplifiers

GENERAL DESCRIPTION

The SGM8277-1/2 are a family of single and dual operational amplifiers, which are optimized for high voltage, high precision, low noise and low power operation. These devices can operate from 4V to 36V single supply or from $\pm 2V$ to $\pm 18V$ dual power supplies, and consume 1100 μA quiescent current per amplifier. The input common mode voltage range is from $(-V_S) + 2V$ to $(+V_S) - 2V$, and the output swing is rail-to-rail with heavy loads.

The SGM8277-1/2 feature a low input offset voltage of $\pm 10\mu V$ (TYP) and a low input bias current of $\pm 10pA$ (TYP). They exhibit a gain-bandwidth product of 4MHz and a slew rate of 3.5V/ μs . They are designed to provide optimal performance in low noise systems. These specifications make the operational amplifiers appropriate for various applications.

The SGM8277-1 is available in Green SOIC-8 and TDFN-3 \times 3-8L packages. The SGM8277-2 is available in Green SOIC-8, MSOP-8 and TDFN-3 \times 3-8L packages. They are specified over the extended industrial temperature range ($-40^{\circ}C$ to $+125^{\circ}C$).

FEATURES

- **Low Offset Voltage:** $\pm 10\mu V$ (TYP)
- **Low Bias Current:** $\pm 10pA$ (TYP)
- **High Open-Loop Voltage Gain:** 140dB (TYP)
- **High PSRR:** 130dB (TYP)
- **High Gain-Bandwidth Product:** 4MHz
- **High Slew Rate:** 3.5V/ μs
- **Settling Time to 0.1% with 10V Step:** 6 μs
- **Overload Recovery Time:** 3 μs
- **Low Noise:** 9nV/ \sqrt{Hz} at 10kHz
- **Rail-to-Rail Output**
- **Support Single or Dual Power Supplies:**
4V to 36V or $\pm 2V$ to $\pm 18V$
- **Input Voltage Range:** $(-V_S) + 2V$ to $(+V_S) - 2V$
- **Low Quiescent Current:** 1100 μA /Amplifier (TYP)
- **$-40^{\circ}C$ to $+125^{\circ}C$ Operating Temperature Range**
- **Small Packaging:**
SGM8277-1 Available in Green SOIC-8 and TDFN-3 \times 3-8L Packages
SGM8277-2 Available in Green SOIC-8, MSOP-8 and TDFN-3 \times 3-8L Packages

APPLICATIONS

- Sensors
- Active Filters
- A/D Converters
- Test Equipment
- Photodiode Amplification
- Battery-Powered Instrumentation

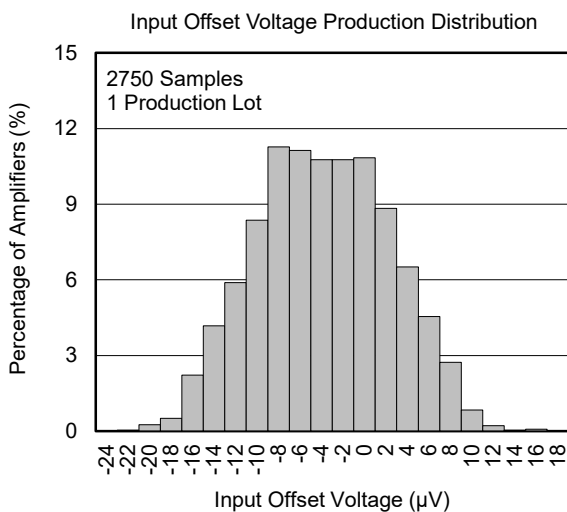

PACKAGE/ORDERING INFORMATION

MODEL	PACKAGE DESCRIPTION	SPECIFIED TEMPERATURE RANGE	ORDERING NUMBER	PACKAGE MARKING	PACKING OPTION
SGM8277-1	SOIC-8	-40°C to +125°C	SGM8277-1XS8G/TR	SGM 82771XS8 XXXXX	Tape and Reel, 4000
	TDFN-3x3-8L	-40°C to +125°C	SGM8277-1XTDB8G/TR	SGM 05BDB XXXXX	Tape and Reel, 4000
SGM8277-2	SOIC-8	-40°C to +125°C	SGM8277-2XS8G/TR	SGM 82772XS8 XXXXX	Tape and Reel, 4000
	MSOP-8	-40°C to +125°C	SGM8277-2XMS8G/TR	SGM05D XMS8 XXXXX	Tape and Reel, 4000
	TDFN-3x3-8L	-40°C to +125°C	SGM8277-2XTDB8G/TR	SGM 05CDB XXXXX	Tape and Reel, 4000

MARKING INFORMATION

NOTE: XXXXX = Date Code, Trace Code and Vendor Code.

XXXXX

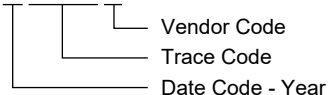

Green (RoHS & HSF): SG Micro Corp defines "Green" to mean Pb-Free (RoHS compatible) and free of halogen substances. If you have additional comments or questions, please contact your SGMICRO representative directly.

ABSOLUTE MAXIMUM RATINGS

Supply Voltage, +V_S to -V_S 38V
 Input Common Mode Voltage Range
 (-V_S) - 0.5V to (+V_S) + 0.5V
 Junction Temperature +150°C
 Storage Temperature Range -65°C to +150°C
 Lead Temperature (Soldering, 10s) +260°C
 ESD Susceptibility
 HBM 4000V
 CDM 1000V

RECOMMENDED OPERATING CONDITIONS

Power Supply Rise Time 200µs (MIN)
 Operating Temperature Range -40°C to +125°C

OVERSTRESS CAUTION

Stresses beyond those listed in Absolute Maximum Ratings may cause permanent damage to the device. Exposure to absolute maximum rating conditions for extended periods may affect reliability. Functional operation of the device at any conditions beyond those indicated in the Recommended Operating Conditions section is not implied.

ESD SENSITIVITY CAUTION

This integrated circuit can be damaged if ESD protections are not considered carefully. SGMICRO recommends that all integrated circuits be handled with appropriate precautions. Failure to observe proper handling and installation procedures can cause damage. ESD damage can range from subtle performance degradation to complete device failure. Precision integrated circuits may be more susceptible to damage because even small parametric changes could cause the device not to meet the published specifications.

DISCLAIMER

SG Micro Corp reserves the right to make any change in circuit design, or specifications without prior notice.

PIN CONFIGURATIONS

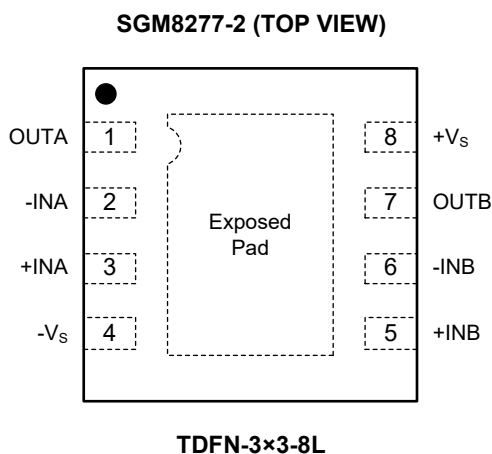
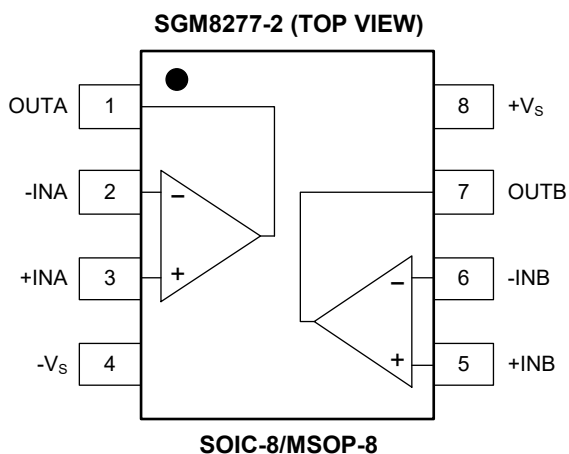
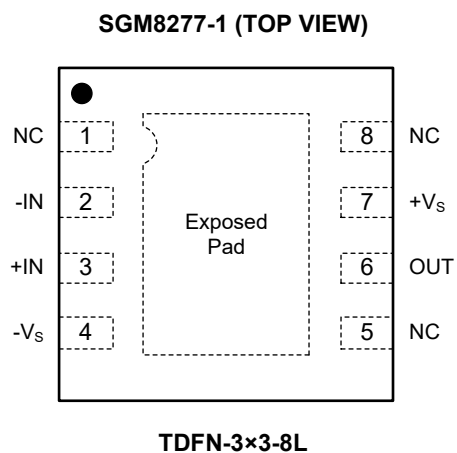
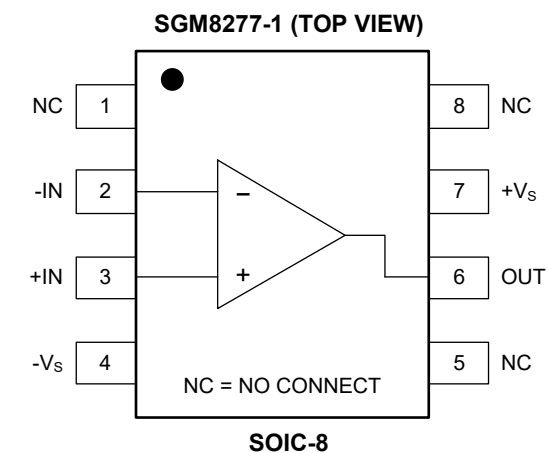

NOTE: For the TDFN-3x3-8L package, exposed pad can be connected to -Vs or left floating.

ELECTRICAL CHARACTERISTICS

($V_S = \pm 2V$ to $\pm 18V$, $V_{CM} = 0V$ and $R_L = 2k\Omega$, Full = $-40^\circ C$ to $+125^\circ C$, typical values are at $T_A = +25^\circ C$, unless otherwise noted.)

PARAMETER		SYMBOL	CONDITIONS	TEMP	MIN	TYP	MAX	UNITS	
Input Characteristics									
Input Offset Voltage	V_{OS}			+25°C		±10	±180	µV	
				Full			±550		
Input Offset Voltage Drift	$\Delta V_{OS}/\Delta T$			Full		1.7		µV/°C	
Input Bias Current	I_B			+25°C		±10	±130	pA	
				Full			±2.6	nA	
Input Offset Current	I_{OS}			+25°C		±10	±130	pA	
				Full			±3.7	nA	
Input Common Mode Voltage Range	V_{CM}			+25°C	$(-V_S) + 2$		$(+V_S) - 2$	V	
Common Mode Rejection Ratio	CMRR			Full	$V_S = 5V, V_{CM} = (-V_S) + 2V$ to $(+V_S) - 2V$	90	120	dB	
				Full	$V_S = 36V, V_{CM} = (-V_S) + 2V$ to $(+V_S) - 2V$	110	130		
Open-Loop Voltage Gain	A_{OL}			Full	$V_S = \pm 2V, V_{OUT} = (-V_S) + 0.5V$ to $(+V_S) - 0.5V$	100	125	dB	
				Full	$V_S = \pm 18V, V_{OUT} = (-V_S) + 0.5V$ to $(+V_S) - 0.5V$	120	140		
Input Impedance	Differential			+25°C		10 5		GΩ pF	
	Common Mode		$V_{CM} = (-V_S) + 2V$ to $(+V_S) - 2V$	+25°C		1 10		TΩ pF	
Output Characteristics									
Output Voltage Swing from Rail	V_{OUT}			Full	$V_S = \pm 2V, R_L = 2k\Omega$		25	50	mV
				Full	$V_S = \pm 18V, R_L = 2k\Omega$		200	380	
				Full	$V_S = \pm 2V, R_L = 10k\Omega$		5	15	
				Full	$V_S = \pm 18V, R_L = 10k\Omega$		40	100	
Output Short-Circuit Current	I_{SC}			Full		±15	±35	mA	
Power Supply									
Operating Voltage Range				Full		±2		±18	V
Power Supply Rejection Ratio	PSRR			Full		110	130		dB
Quiescent Current/Amplifier	I_Q		$V_S = \pm 18V, I_{OUT} = 0A$	+25°C			±1100	±1650	µA
				Full				±2400	
Dynamic Performance									
Gain-Bandwidth Product	GBP		$C_L = 50pF$	+25°C			4		MHz
Phase Margin	ϕ_O		$C_L = 50pF$	+25°C			60		°
Slew Rate	SR			+25°C			3.5		V/µs
Settling Time to 0.1%	t_S		$G = +1, 10V$ output step	+25°C			6		µs
Overload Recovery Time			$V_{IN} \times G = V_S$	+25°C			3		µs
Total Harmonic Distortion + Noise	THD+N		$G = +1, f = 1kHz, V_{OUT} = 3.5V_{RMS}$	+25°C			0.0005		%
Channel Separation (SGM8277-2)			DC	+25°C			0.1		µV/V
Noise Performance									
Input Voltage Noise			$f = 0.1Hz$ to $10Hz$	+25°C			2		µV _{P-P}
Input Voltage Noise Density	e_n		$f = 100Hz$	+25°C			40		nV/√Hz
			$f = 10kHz$	+25°C			9		
Input Current Noise Density	i_n		$f = 1kHz$	+25°C			0.5		fA/√Hz

TYPICAL PERFORMANCE CHARACTERISTICS

At $T_A = +25^\circ\text{C}$, $V_S = 30\text{V}$, $R_L = 2\text{k}\Omega$, unless otherwise noted.

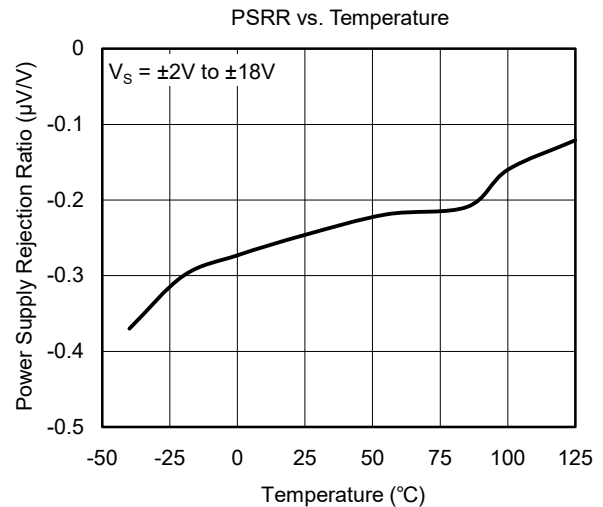
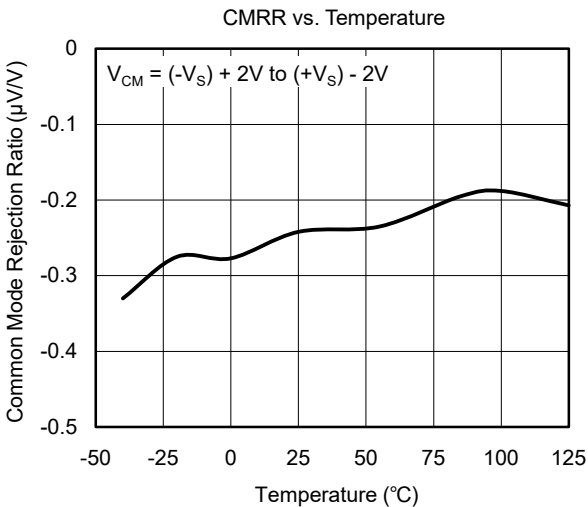
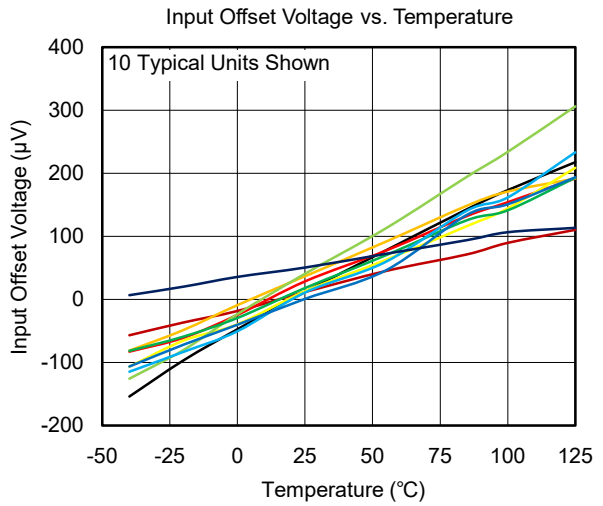
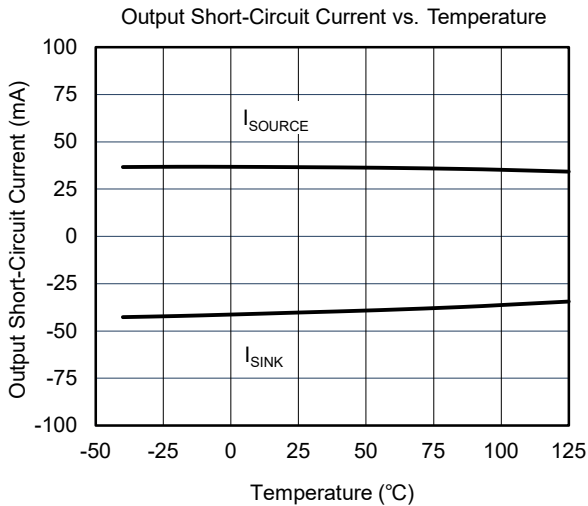
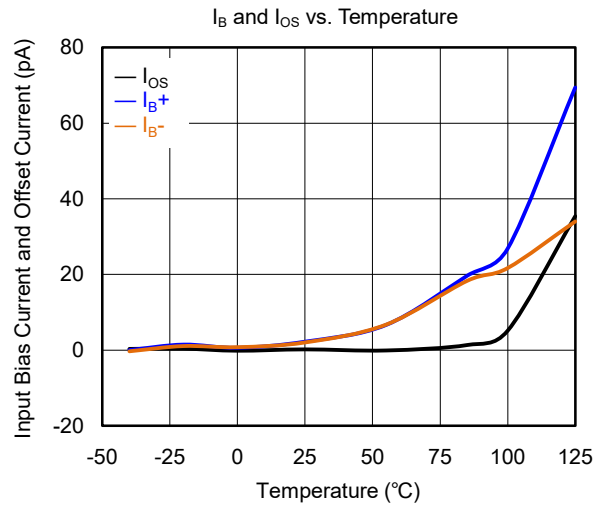
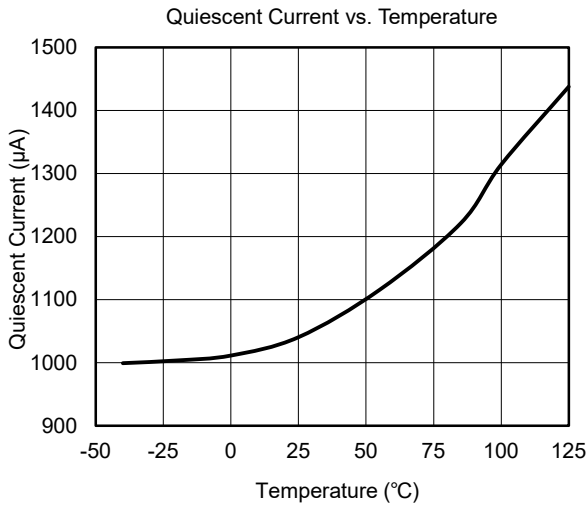

TYPICAL PERFORMANCE CHARACTERISTICS (continued)

At $T_A = +25^\circ\text{C}$, $V_S = 30\text{V}$, $R_L = 2\text{k}\Omega$, unless otherwise noted.

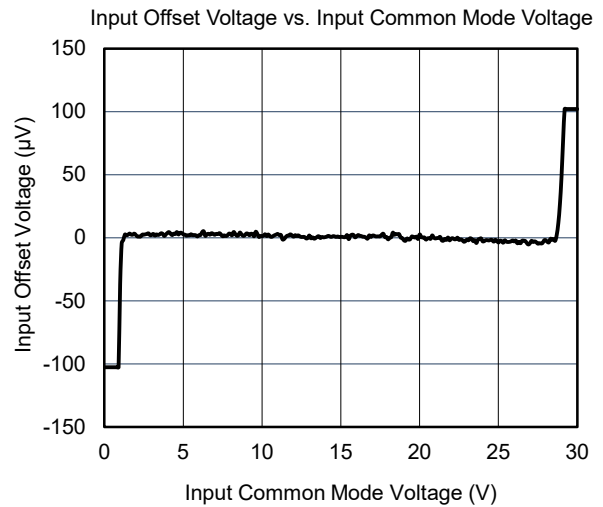
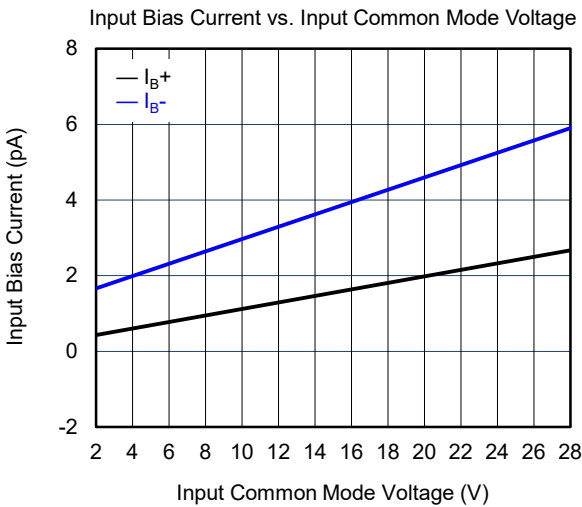
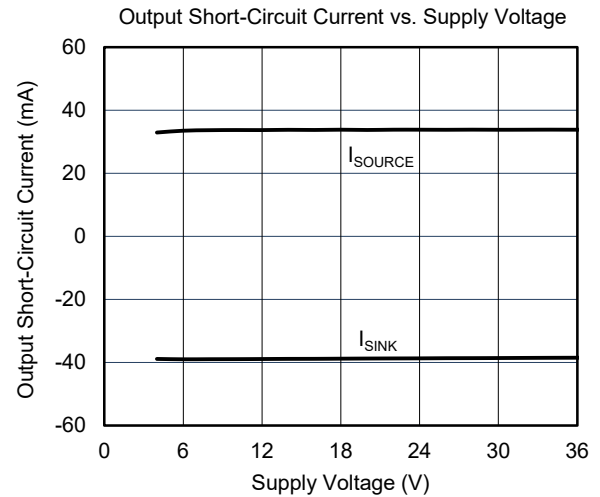
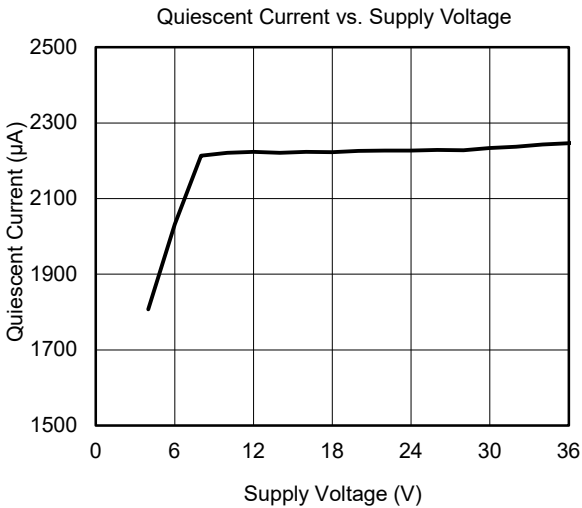
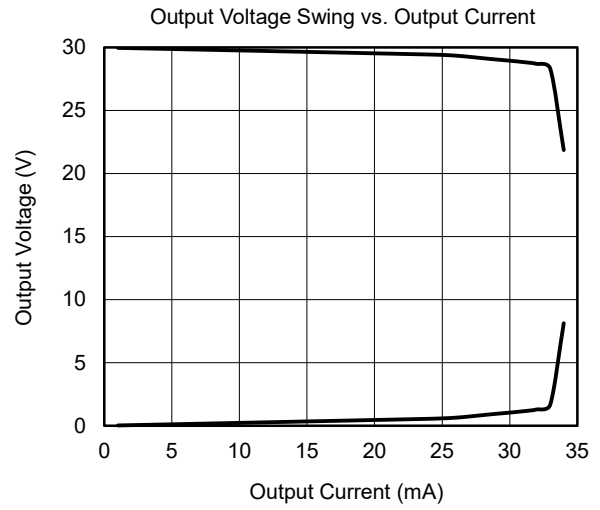
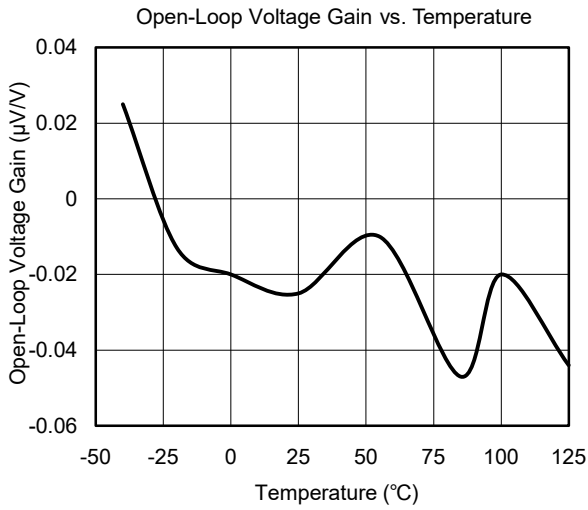

TYPICAL PERFORMANCE CHARACTERISTICS (continued)

At $T_A = +25^\circ\text{C}$, $V_S = 30\text{V}$, $R_L = 2\text{k}\Omega$, unless otherwise noted.

Small-Signal Step Response

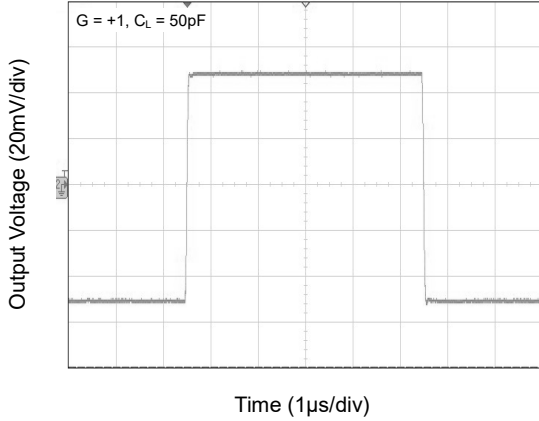

Large-Signal Step Response

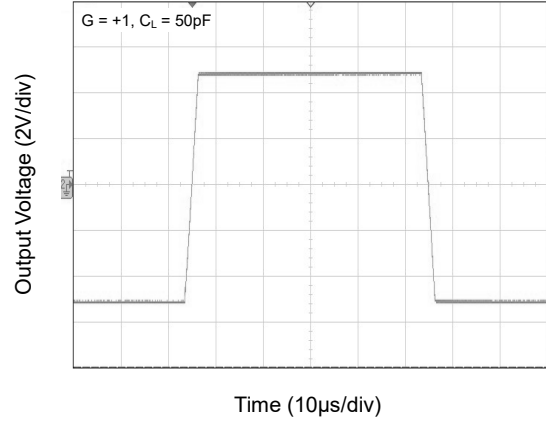

No Phase Reversal

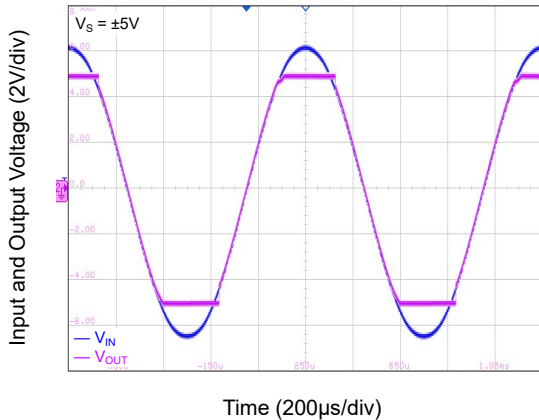

0.1Hz to 10Hz Input Voltage Noise

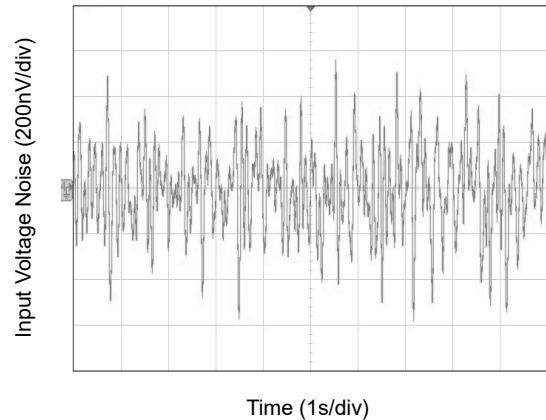

Maximum Output Voltage vs. Frequency

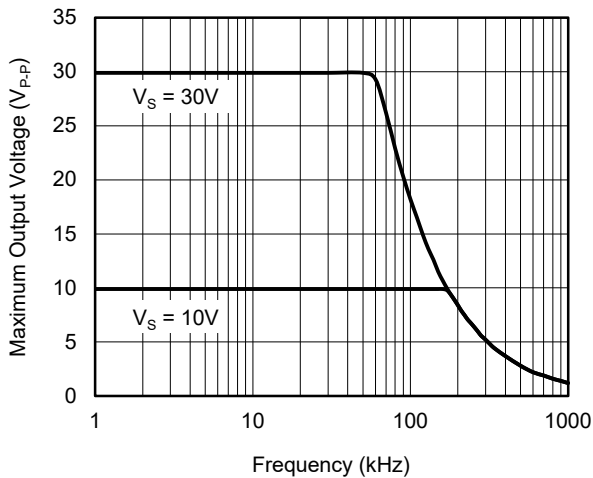

Open-Loop Gain and Phase vs. Frequency

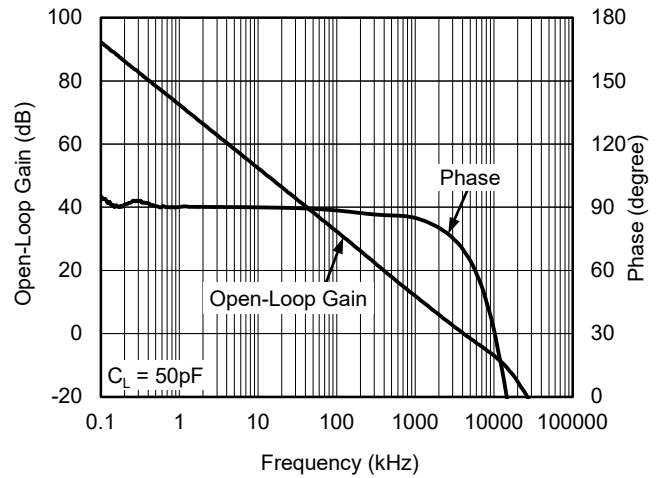

TYPICAL PERFORMANCE CHARACTERISTICS (continued)

At $T_A = +25^\circ\text{C}$, $V_S = 30\text{V}$, $R_L = 2\text{k}\Omega$, unless otherwise noted.

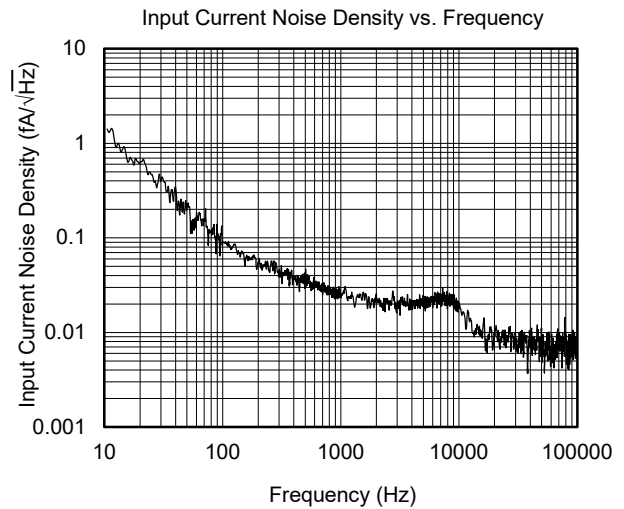
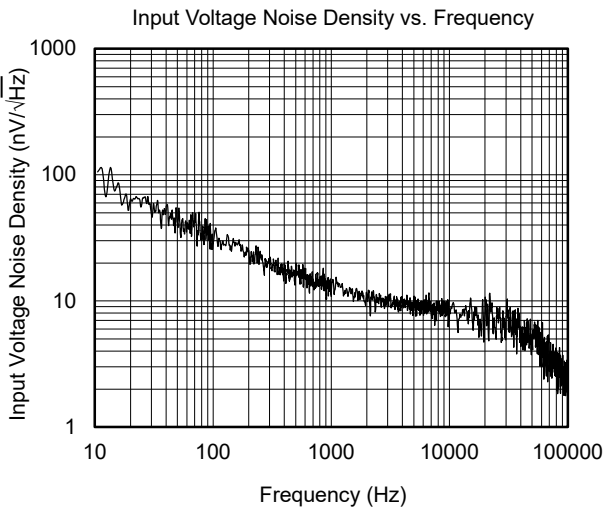
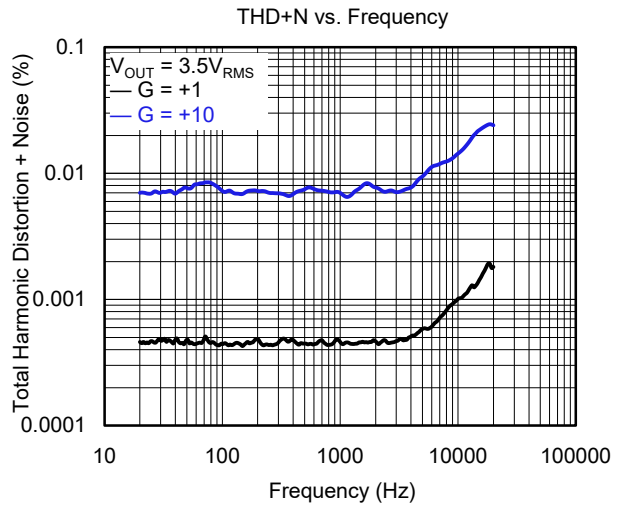
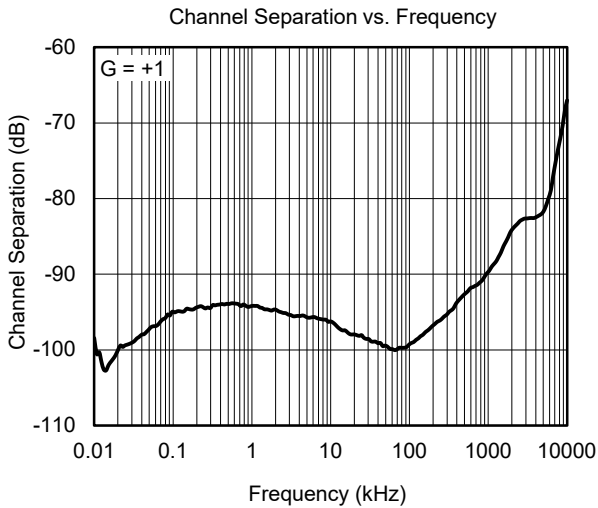
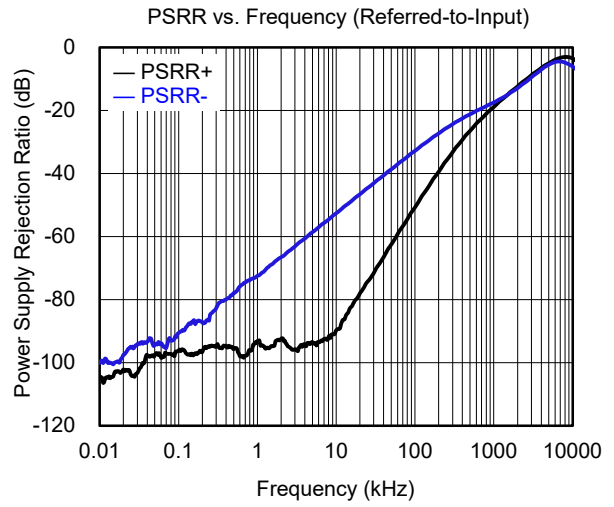
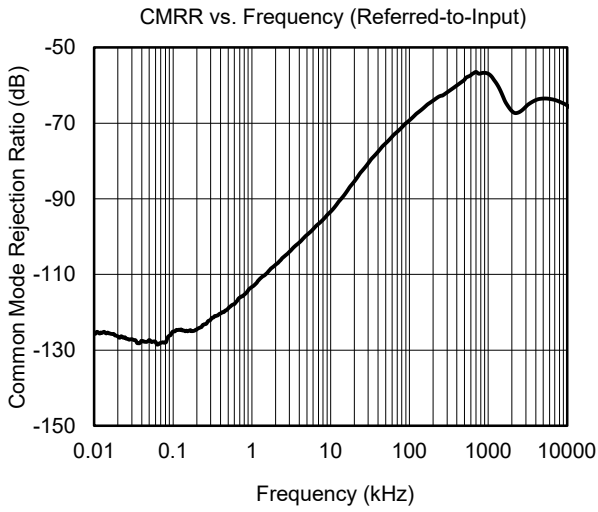

TYPICAL PERFORMANCE CHARACTERISTICS (continued)

At $T_A = +25^\circ\text{C}$, $V_S = 30\text{V}$, $R_L = 2\text{k}\Omega$, unless otherwise noted.

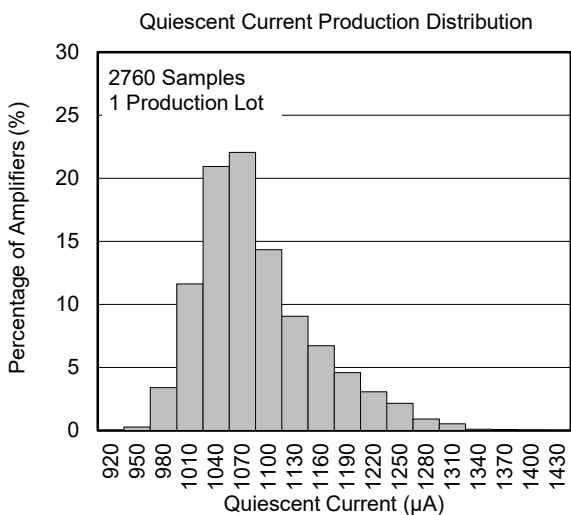
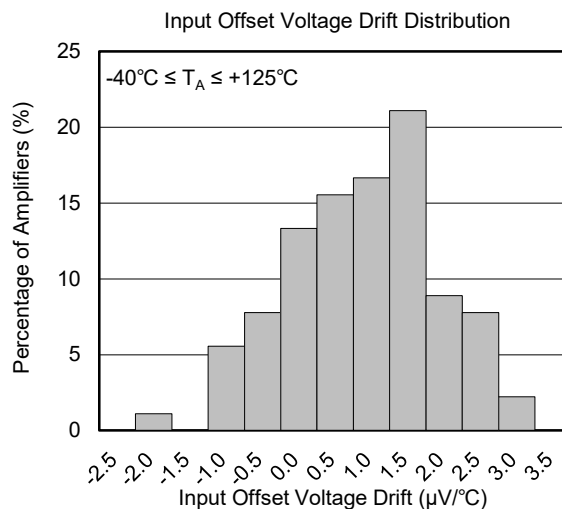
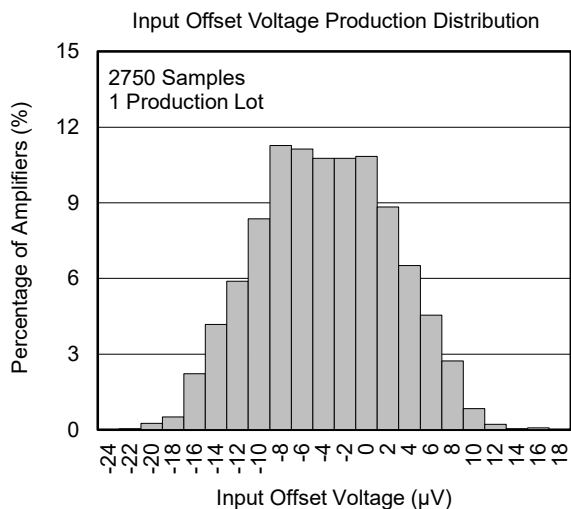

APPLICATION INFORMATION

Rail-to-Rail Output

The SGM8277-1/2 support rail-to-rail output operation. In single power supply application, for example, when $+V_S = 36V$, $-V_S = GND$, $10k\Omega$ load resistor is tied from OUT pin to ground, the typical output swing range is from 0.04V to 35.96V.

Driving Capacitive Loads

The SGM8277-1/2 are designed for driving the 500pF capacitive load with unity-gain stable. If greater capacitive load must be driven in application, the circuit in Figure 1 can be used. In this circuit, the IR drop voltage generated by R_{ISO} is compensated by feedback loop.

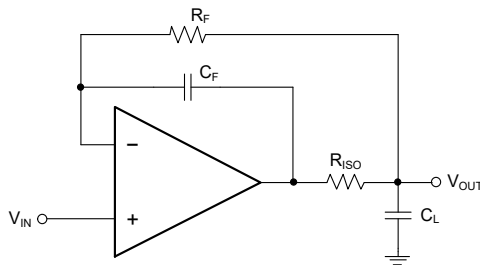

Figure 1. Circuit to Drive Heavy Capacitive Load

Power Supply Decoupling and Layout

A clean and low noise power supply is very important in amplifier circuit design, besides of input signal noise, the power supply is one of important source of noise to the amplifiers through $+V_S$ and $-V_S$ pins. Power supply bypassing is an effective method to clear up the noise at power supply, and the low impedance path to ground of decoupling capacitor will bypass the noise to GND. In application, $10\mu F$ ceramic capacitor paralleled with $0.1\mu F$ or $0.01\mu F$ ceramic capacitor is used in Figure 2. The ceramic capacitors should be placed as close as possible to $+V_S$ and $-V_S$ power supply pins.

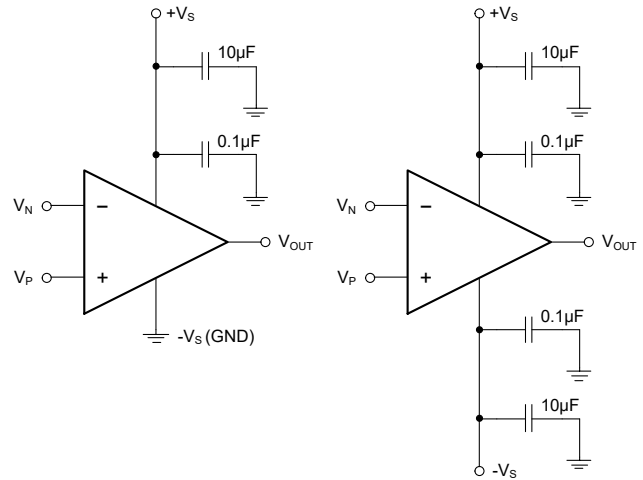

Figure 2. Amplifier Power Supply Bypassing

Grounding

In low speed application, one node grounding technique is the simplest and most effective method to eliminate the noise generated by grounding. In high speed application, the general method to eliminate noise is to use a complete ground plane technique, and the whole ground plane will help distribute heat and reduce EMI noise pickup.

Reduce Input-to-Output Coupling

To reduce the input-to-output coupling, the input traces must be placed as far away from the power supply or output traces as possible. The sensitive trace must not be placed in parallel with the noisy trace in same layer. They must be placed perpendicularly in different layers to reduce the crosstalk. These PCB layout techniques will help to reduce unwanted positive feedback and noise.

APPLICATION INFORMATION (continued)

Typical Application Circuits

Difference Amplifier

The circuit in Figure 3 is a design example of classical difference amplifier. If $R_4/R_3 = R_2/R_1$, then $V_{OUT} = (V_P - V_N) \times R_2/R_1 + V_{REF}$.

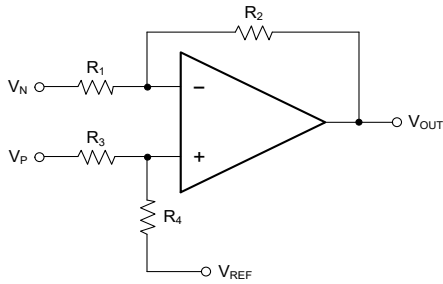

Figure 3. Difference Amplifier

High Input Impedance Difference Amplifier

The circuit in Figure 4 is a design example of high input impedance difference amplifier. The added amplifiers at the input are used to increase the input impedance and eliminate drawback of low input impedance in Figure 3.

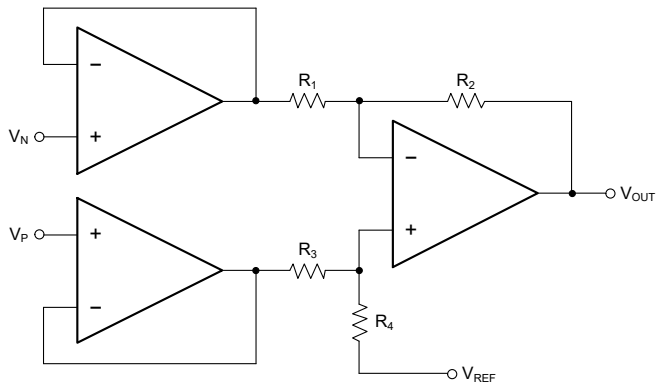

Figure 4. High Input Impedance Difference Amplifier

Active Low-Pass Filter

The circuit in Figure 5 is a design example of active low-pass filter, the DC gain is equal to $-R_2/R_1$ and the -3dB corner frequency is equal to $1/2\pi R_2 C$. In this design, the filter bandwidth must be less than the bandwidth of the amplifier, and the resistor values must be selected as low as possible to reduce ringing or oscillation generated by the parasitic parameters in PCB layout.

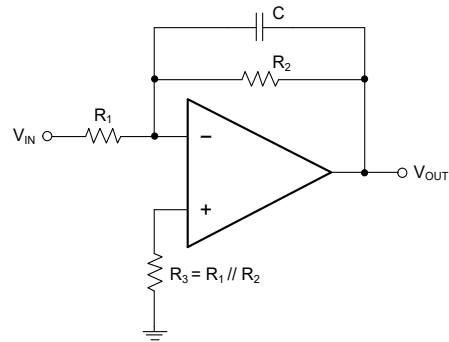

Figure 5. Active Low-Pass Filter

REVISION HISTORY

NOTE: Page numbers for previous revisions may differ from page numbers in the current version.

Changes from Original (NOVEMBER 2023) to REV.A

Page

Changed from product preview to production data.....All

PACKAGE OUTLINE DIMENSIONS

SOIC-8

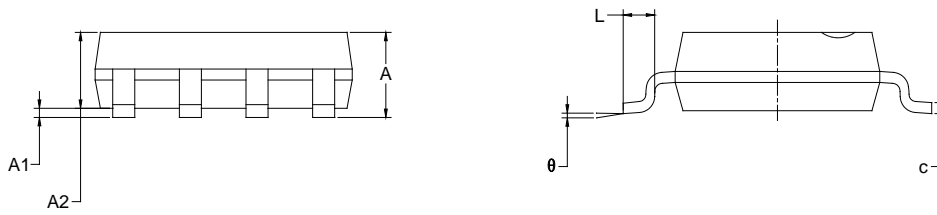
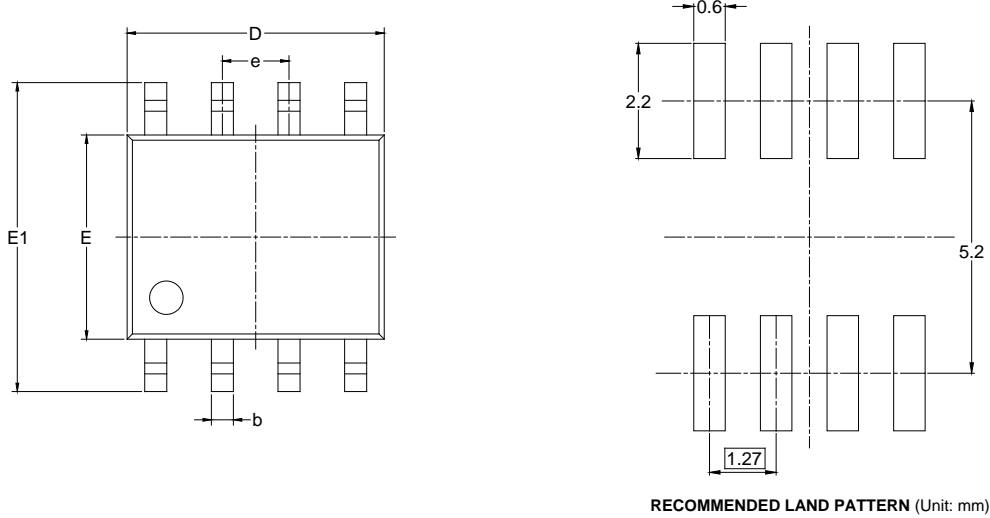

Symbol	Dimensions In Millimeters		Dimensions In Inches	
	MIN	MAX	MIN	MAX
A	1.350	1.750	0.053	0.069
A1	0.100	0.250	0.004	0.010
A2	1.350	1.550	0.053	0.061
b	0.330	0.510	0.013	0.020
c	0.170	0.250	0.006	0.010
D	4.700	5.100	0.185	0.200
E	3.800	4.000	0.150	0.157
E1	5.800	6.200	0.228	0.244
e	1.27 BSC		0.050 BSC	
L	0.400	1.270	0.016	0.050
θ	0°	8°	0°	8°

NOTES:
 1. Body dimensions do not include mode flash or protrusion.
 2. This drawing is subject to change without notice.

PACKAGE OUTLINE DIMENSIONS

MSOP-8

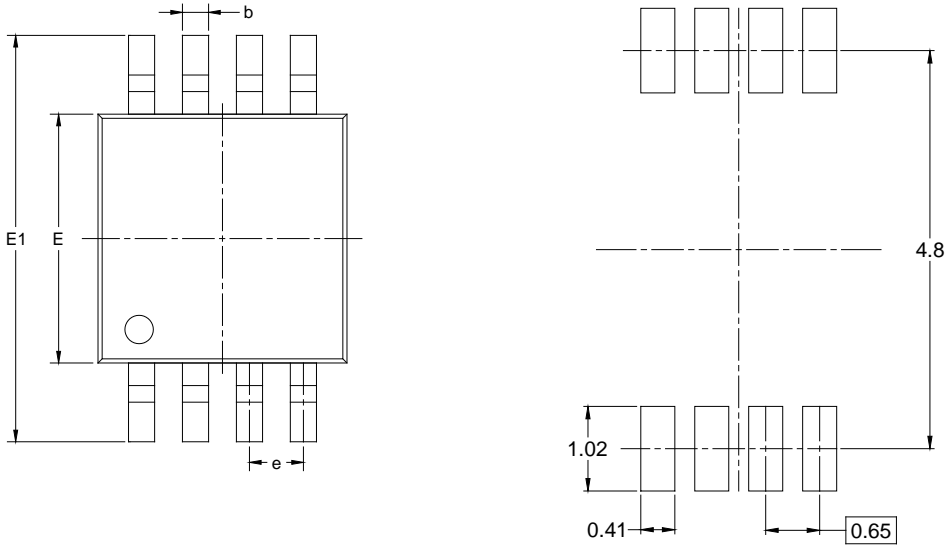

RECOMMENDED LAND PATTERN (Unit: mm)

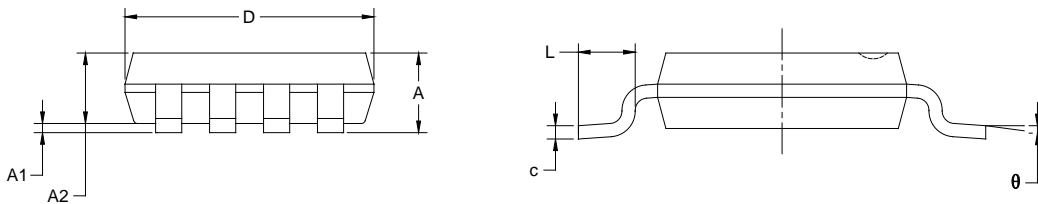

Symbol	Dimensions In Millimeters		Dimensions In Inches	
	MIN	MAX	MIN	MAX
A	0.820	1.100	0.032	0.043
A1	0.020	0.150	0.001	0.006
A2	0.750	0.950	0.030	0.037
b	0.250	0.380	0.010	0.015
c	0.090	0.230	0.004	0.009
D	2.900	3.100	0.114	0.122
E	2.900	3.100	0.114	0.122
E1	4.750	5.050	0.187	0.199
e	0.650 BSC		0.026 BSC	
L	0.400	0.800	0.016	0.031
θ	0°	6°	0°	6°

NOTES:

1. Body dimensions do not include mode flash or protrusion.
2. This drawing is subject to change without notice.

PACKAGE OUTLINE DIMENSIONS

TDFN-3x3-8L

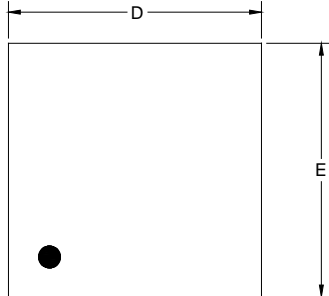

TOP VIEW

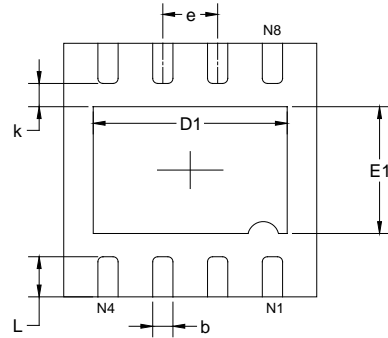

BOTTOM VIEW

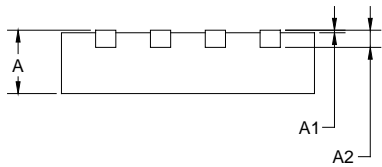

SIDE VIEW

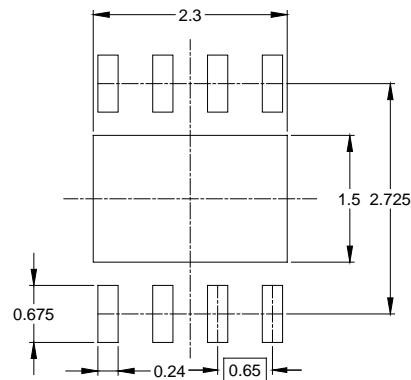

RECOMMENDED LAND PATTERN (Unit: mm)

Symbol	Dimensions In Millimeters		Dimensions In Inches	
	MIN	MAX	MIN	MAX
A	0.700	0.800	0.028	0.031
A1	0.000	0.050	0.000	0.002
A2	0.203 REF		0.008 REF	
D	2.900	3.100	0.114	0.122
D1	2.200	2.400	0.087	0.094
E	2.900	3.100	0.114	0.122
E1	1.400	1.600	0.055	0.063
k	0.200 MIN		0.008 MIN	
b	0.180	0.300	0.007	0.012
e	0.650 TYP		0.026 TYP	
L	0.375	0.575	0.015	0.023

NOTE: This drawing is subject to change without notice.

PACKAGE INFORMATION

TAPE AND REEL INFORMATION

REEL DIMENSIONS



TAPE DIMENSIONS



NOTE: The picture is only for reference. Please make the object as the standard.

KEY PARAMETER LIST OF TAPE AND REEL

Package Type	Reel Diameter	Reel Width W1 (mm)	A0 (mm)	B0 (mm)	K0 (mm)	P0 (mm)	P1 (mm)	P2 (mm)	W (mm)	Pin1 Quadrant
SOIC-8	13"	12.4	6.40	5.40	2.10	4.0	8.0	2.0	12.0	Q1
MSOP-8	13"	12.4	5.20	3.30	1.50	4.0	8.0	2.0	12.0	Q1
TDFN-3×3-8L	13"	12.4	3.35	3.35	1.13	4.0	8.0	2.0	12.0	Q2

DD0001

PACKAGE INFORMATION

CARTON BOX DIMENSIONS



NOTE: The picture is only for reference. Please make the object as the standard.

KEY PARAMETER LIST OF CARTON BOX

Reel Type	Length (mm)	Width (mm)	Height (mm)	Pizza/Carton
13"	386	280	370	5

DD0002