



SGM9126

6-Channel, 5th-Order, Standard Definition Video Filter Driver

GENERAL DESCRIPTION

The SGM9126 is a rail-to-rail, 6-channel, 5th-order output reconstruction filter with input clamps which can operate from 3.3V to 5.5V single power supply, while consuming an ultra-low 44mA quiescent current. The device is optimized for low power, wide range of television and set-top box applications.

The device has a -3dB bandwidth of 8MHz and 35V/ μ s slew rate, allowing DC- or AC-coupled output. SGM9126 can be DC-coupled or AC-coupled with input video signal to eliminate out-of-band noise, such as the output stage of DAC.

The SGM9126 is available in a Green TSSOP-14 package. It operates over an ambient temperature range of -40°C to +85°C.

FEATURES

- **Supply Voltage Range: 3.3V to 5.5V**
- **6-Channel 5th-Order 8MHz (SD) Filter**
- **Transparent Input Clamping**
- **Internal Gain: 6dB**
- **Quiescent Current: 30mA (TYP)**
- **AC- or DC-Coupled Inputs**
- **AC- or DC-Coupled Outputs**
- **Rail-to-Rail Output**
- **-40°C to +85°C Operating Temperature Range**
- **Available in a Green TSSOP-14 Package**

APPLICATIONS

- Video Amplifiers
- Video Recorders
- Video on Demand (VOD)
- Cable and Satellite Set-Top Boxes
- Portable and Handheld Products
- Communication Devices
- TVs

BLOCK DIAGRAM

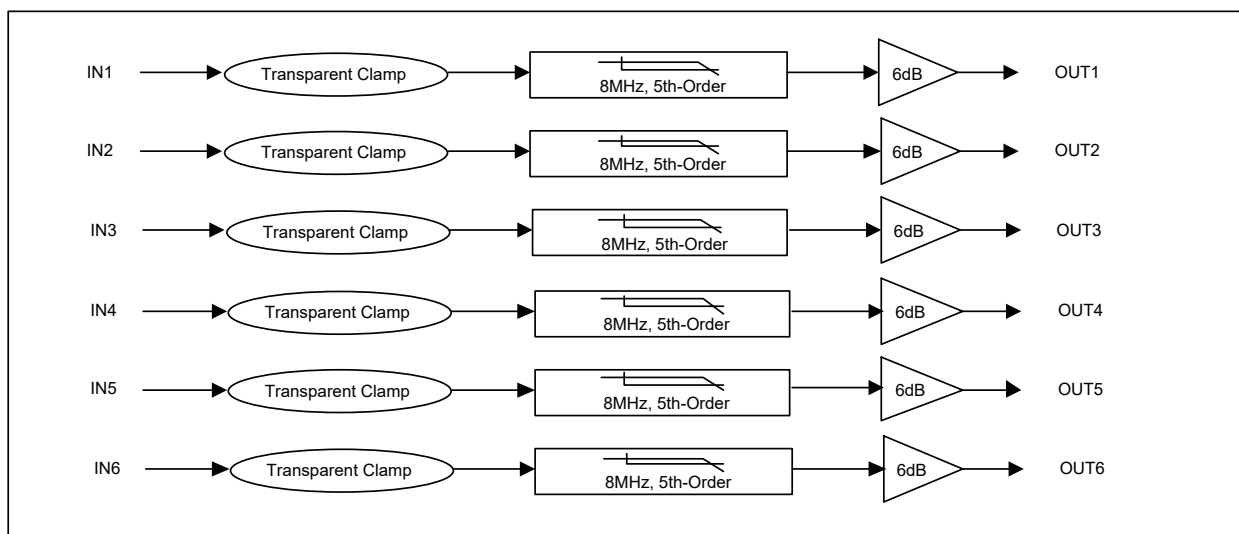

PACKAGE/ORDERING INFORMATION

MODEL	PACKAGE DESCRIPTION	SPECIFIED TEMPERATURE RANGE	ORDERING NUMBER	PACKAGE MARKING	PACKING OPTION
SGM9126	TSSOP-14	-40°C to +85°C	SGM9126YTS14G/TR	SGM9126 YTS14 XXXXX	Tape and Reel, 3000

MARKING INFORMATION

NOTE: XXXXX = Date Code and Vendor Code.

XXXXX

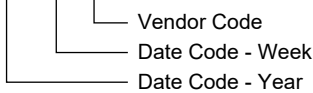

Green (RoHS & HSF): SG Micro Corp defines "Green" to mean Pb-Free (RoHS compatible) and free of halogen substances. If you have additional comments or questions, please contact your SGMICRO representative directly.

ABSOLUTE MAXIMUM RATINGS

- Input Voltage Range GND - 0.3V to $V_{CC} + 0.3V$
- Supply Voltage, V_{CC} 6.0V
- Junction Temperature +150°C
- Storage Temperature Range..... -65°C to +150°C
- Lead Temperature (Soldering, 10s) +260°C
- ESD Susceptibility
- HBM..... 8000V
- MM..... 400V

RECOMMENDED OPERATING CONDITIONS

- Operating Voltage Range..... 3.3V to 5.5V
- Operating Temperature Range -40°C to +85°C

OVERSTRESS CAUTION

Stresses beyond those listed in Absolute Maximum Ratings may cause permanent damage to the device. Exposure to absolute maximum rating conditions for extended periods may affect reliability. Functional operation of the device at any conditions beyond those indicated in the Recommended Operating Conditions section is not implied.

ESD SENSITIVITY CAUTION

This integrated circuit can be damaged if ESD protections are not considered carefully. SGMICRO recommends that all integrated circuits be handled with appropriate precautions. Failure to observe proper handling and installation procedures can cause damage. ESD damage can range from subtle performance degradation to complete device failure. Precision integrated circuits may be more susceptible to damage because even small parametric changes could cause the device not to meet the published specifications.

DISCLAIMER

SG Micro Corp reserves the right to make any change in circuit design, or specifications without prior notice.

PIN CONFIGURATION

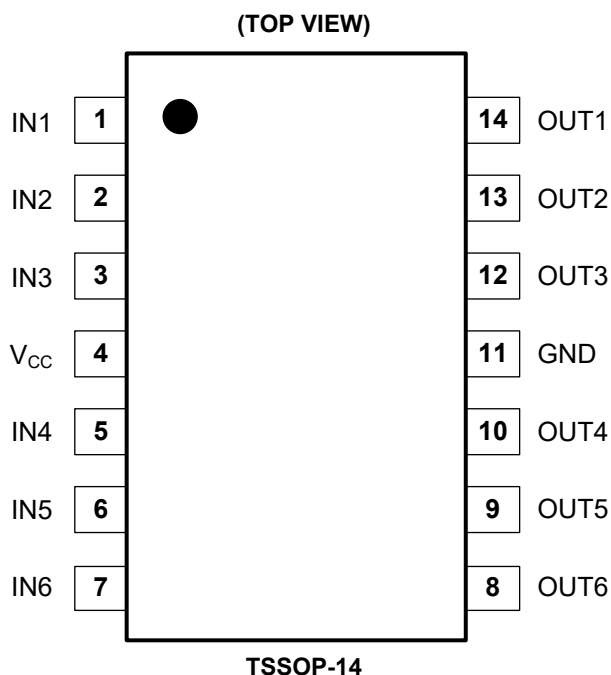

PIN DESCRIPTION

PIN	NAME	FUNCTION
1	IN1	Video Input for Channel 1.
2	IN2	Video Input for Channel 2.
3	IN3	Video Input for Channel 3.
4	V _{cc}	Power Supply.
5	IN4	Video Input for Channel 4.
6	IN5	Video Input for Channel 5.
7	IN6	Video Input for Channel 6.
8	OUT6	Filtered Output for Channel 6.
9	OUT5	Filtered Output for Channel 5.
10	OUT4	Filtered Output for Channel 4.
11	GND	Ground.
12	OUT3	Filtered Output for Channel 3.
13	OUT2	Filtered Output for Channel 2.
14	OUT1	Filtered Output for Channel 1.

ELECTRICAL CHARACTERISTICS

(At $R_L = 150\Omega$ connected to GND, $V_{IN} = 1V_{PP}$ and $C_{IN} = 0.1\mu F$, all outputs AC-coupled with $220\mu F$, referenced to 400kHz, unless otherwise noted.)

PARAMETER	CONDITIONS	TEMP	MIN	TYP	MAX	UNITS
Input Characteristics						
Output Level Shift Voltage (V_{OLS})	$V_{IN} = 0V$, No load	+25°C		396	550	mV
		-40°C to +85°C			752	
Input Voltage Clamp (V_{CLAMP})	$I_{IN} = -3.5mA$	+25°C	-180	-110		mV
		-40°C to +85°C	-270			
Clamp Charge Current	$V_{IN} = V_{CLAMP} - 100mV$	+25°C	-6.0	-4.75		mA
		-40°C to +85°C	-6.5			
Voltage Gain (A_V)	$R_L = 150\Omega$	+25°C	5.7	6	6.4	dB
		-40°C to +85°C	5.6		6.5	
Output Characteristics						
Output Voltage High Swing	$V_{IN} = 3V$, $R_L = 150\Omega$ to GND	+25°C	4.60	4.75		V
		-40°C to +85°C	4.53			
Power Supply						
Operating Voltage Range		+25°C	3.3		5.5	V
Power Supply Rejection Ratio (PSRR)	$V_{CC} = 3.5V$ to $5.0V$	+25°C	44	51		dB
		-40°C to +85°C	37			
Quiescent Current (I_Q)	$V_{IN} = 0.5V$	+25°C		44	55	mA
		-40°C to +85°C			63	
AC Performance						
-0.1dB Bandwidth	$R_L = 150\Omega$	+25°C		5.7		MHz
-3dB Bandwidth	$R_L = 150\Omega$	+25°C		7.7		MHz
Filter Response (Normalized Gain)	$f_{IN} = 27MHz$	+25°C		44		dB
Slew Rate	2V Output step, 80% to 20%	+25°C		35		V/ μs
Differential Gain (DG)	PAL DC-coupled	+25°C		0.19		%
	PAL AC-coupled	+25°C		0.27		%
Differential Phase (DP)	PAL DC-coupled	+25°C		1.03		°
	PAL AC-coupled	+25°C		1.19		°
Group Delay Variation (D/DT)	Difference between 400kHz and 6.5MHz	+25°C		30.5		ns
Crosstalk (channel-to-channel)	$f = 1MHz$	+25°C		-66		dB
Fall Time	2V Output step, 80% to 20%	+25°C		34.2		ns
Rise Time	2V Output step, 80% to 20%	+25°C		35.4		ns

TYPICAL PERFORMANCE CHARACTERISTICS

At $V_{CC} = 5V$, $T_A = +25^{\circ}C$, $R_L = 150\Omega$, all outputs AC-coupled with $220\mu F$, unless otherwise noted.

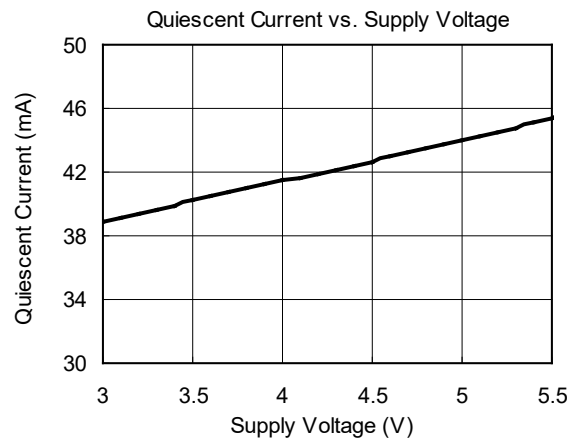
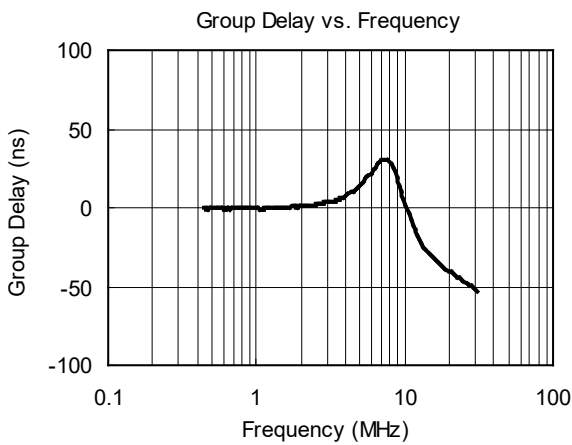
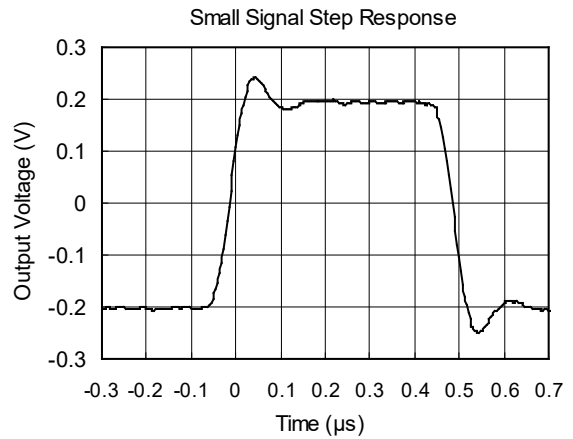
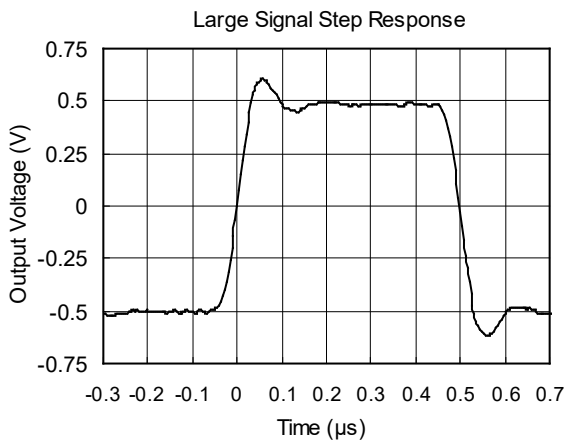
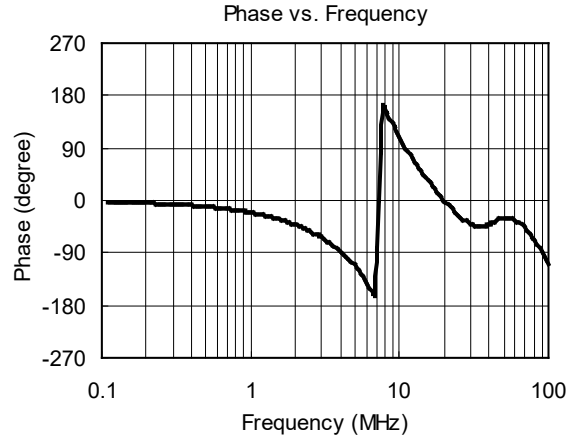
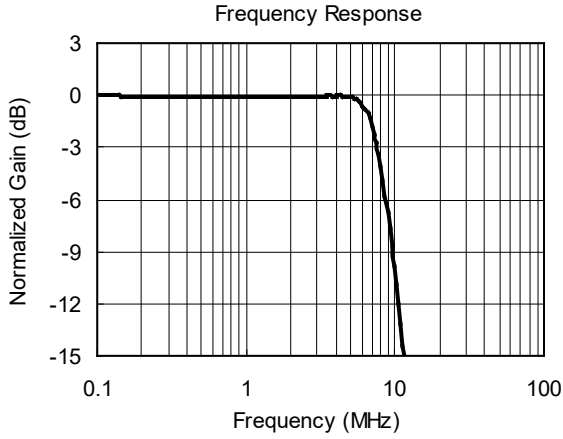

TYPICAL PERFORMANCE CHARACTERISTICS (continued)

At $V_{CC} = 5V$, $T_A = +25^\circ C$, $R_L = 150\Omega$, all outputs AC-coupled with $220\mu F$, unless otherwise noted.

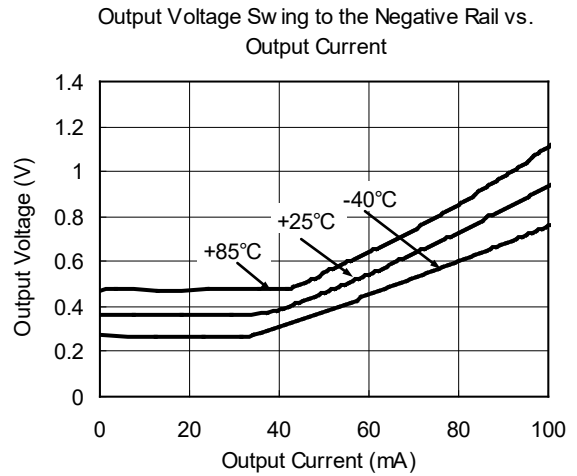
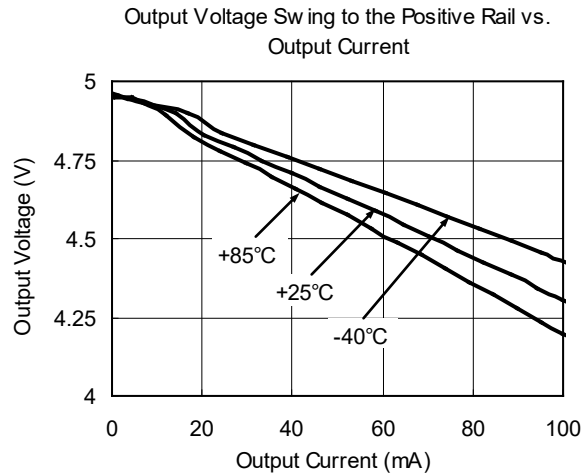
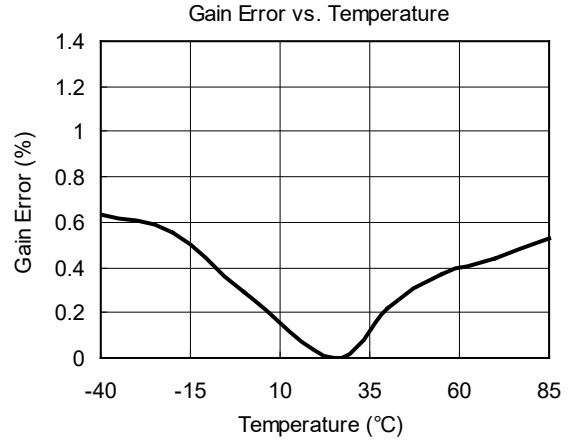
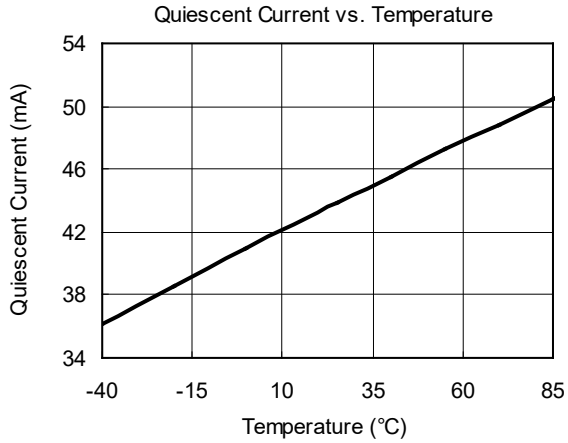

PACKAGE OUTLINE DIMENSIONS

TSSOP-14

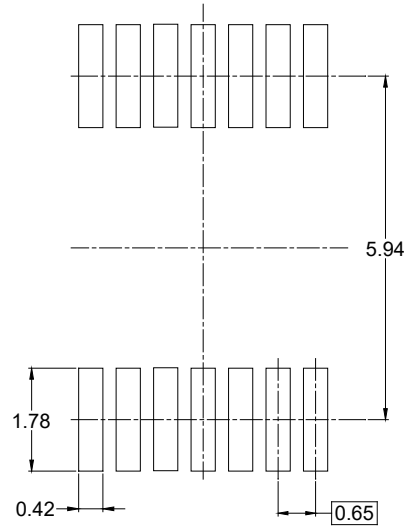
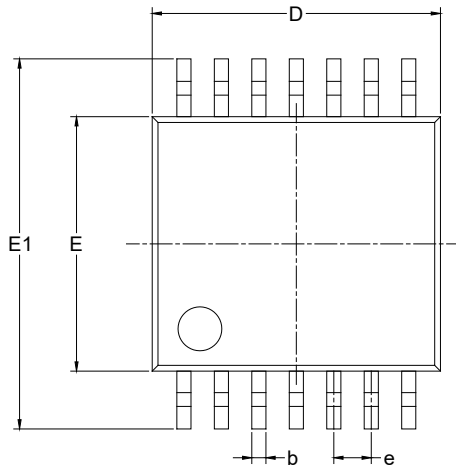

RECOMMENDED LAND PATTERN (Unit: mm)

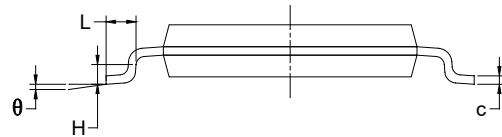
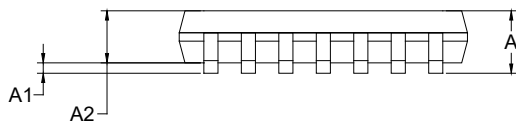

Symbol	Dimensions In Millimeters		Dimensions In Inches	
	MIN	MAX	MIN	MAX
A		1.100		0.043
A1	0.050	0.150	0.002	0.006
A2	0.800	1.000	0.031	0.039
b	0.190	0.300	0.007	0.012
c	0.090	0.200	0.004	0.008
D	4.900	5.100	0.193	0.201
E	4.300	4.500	0.169	0.177
E1	6.250	6.550	0.246	0.258
e	0.650 BSC		0.026 BSC	
L	0.500	0.700	0.02	0.028
H	0.25 TYP		0.01 TYP	
θ	1°	7°	1°	7°

NOTES:

1. Body dimensions do not include mode flash or protrusion.
2. This drawing is subject to change without notice.

PACKAGE INFORMATION

TAPE AND REEL INFORMATION

REEL DIMENSIONS



TAPE DIMENSIONS



NOTE: The picture is only for reference. Please make the object as the standard.

KEY PARAMETER LIST OF TAPE AND REEL

Package Type	Reel Diameter	Reel Width W1 (mm)	A0 (mm)	B0 (mm)	K0 (mm)	P0 (mm)	P1 (mm)	P2 (mm)	W (mm)	Pin1 Quadrant
TSSOP-14	13"	12.4	6.95	5.60	1.20	4.0	8.0	2.0	12.0	Q1

000001

PACKAGE INFORMATION

CARTON BOX DIMENSIONS



NOTE: The picture is only for reference. Please make the object as the standard.

KEY PARAMETER LIST OF CARTON BOX

Reel Type	Length (mm)	Width (mm)	Height (mm)	Pizza/Carton
13"	386	280	370	5

DD0002