



SGM8706

Micro-Power, RRIO, 1.8V, Push-Pull Output Comparator with Integrated Voltage Reference

GENERAL DESCRIPTION

The SGM8706 is a single, rail-to-rail input and output comparator with typical 2.2 μ A low power supply current. The comparator operates from a wide range of 1.8V to 5.5V supply voltage, and is guaranteed to operate at 1.8V and 5V. This feature is suitable for battery-powered applications.

The SGM8706 is optimized for micro-power, single-supply operation. The push-pull output stage supports rail-to-rail output swing and allows the operation with absolute minimum power consumption when driving any capacitive or resistive load. It also has a latch enable input (\overline{LE}) pin.

The product features an uncommitted internal voltage reference, comparator input common-mode around 200mV outside the power supply rails and can be operated from 1.8V to 5.5V. The internal 1.2V series voltage reference offers low 42 μ V/ $^{\circ}$ C drift, is stable at 10nF capacitive load, and can produce output current up to 2mA (TYP).

The SGM8706 is available in Green SOT-23-6, SOT-23-8 and SOIC-8 packages. The small packages make this device ideal for use in hand-held electronics and mobile phone applications. It is rated over the -40 $^{\circ}$ C to +85 $^{\circ}$ C temperature range.

FEATURES

- **Low Quiescent Current:**
2.2 μ A (TYP) at $V_S = 1.8V$
- **Wide Single-Supply Voltage Range: 1.8V to 5.5V**
- **Latch Function Included**
- **Push-Pull Output Current Drive:**
18mA (TYP) at $V_S = 5V$
- **Rail-to-Rail Input and Output**
- **Internal 1.2V Reference Voltage**
- **-40 $^{\circ}$ C to +85 $^{\circ}$ C Operating Temperature Range**
- **Available in Green SOT-23-6, SOT-23-8 and SOIC-8 Packages**

APPLICATIONS

Portable and Battery-Powered Applications
Alarm and Surveillance Circuits
Mobile Phones
RC Timers
Hand-Held Electronics
Window Detectors
IR Receiver

Micro-Power, RRIO, 1.8V, Push-Pull Output Comparator with Integrated Voltage Reference

SGM8706

PACKAGE/ORDERING INFORMATION

MODEL	PACKAGE DESCRIPTION	SPECIFIED TEMPERATURE RANGE	ORDERING NUMBER	PACKAGE MARKING	PACKING OPTION
SGM8706	SOT-23-6	-40°C to +85°C	SGM8706YN6G/TR	SGDXX	Tape and Reel, 3000
	SOT-23-8	-40°C to +85°C	SGM8706YN8G/TR	SGEXX	Tape and Reel, 3000
	SOIC-8	-40°C to +85°C	SGM8706YS8G/TR	SGM 8706YS8 XXXXX	Tape and Reel, 2500

MARKING INFORMATION

NOTE: XX = Date Code. XXXXXX = Date Code and Vendor Code.

SOT-23-6/SOT-23-8

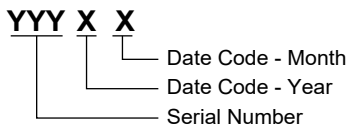

SOIC-8

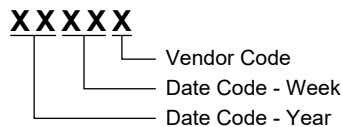

Green (RoHS & HSF): SG Micro Corp defines "Green" to mean Pb-Free (RoHS compatible) and free of halogen substances. If you have additional comments or questions, please contact your SGMICRO representative directly.

ABSOLUTE MAXIMUM RATINGS

Supply Voltage, +V _S to -V _S	6V
V _{IN} Differential	±(+V _S - (-V _S))
Voltage at Input/Output Pins	(-V _S) - 0.3V to (+V _S) + 0.3V
Junction Temperature	+150°C
Storage Temperature Range	-65°C to +150°C
Lead Temperature (Soldering, 10s)	+260°C
ESD Susceptibility	
HBM	4000V
MM	400V

RECOMMENDED OPERATING CONDITIONS

Operating Temperature Range	-40°C to +85°C
-----------------------------------	----------------

OVERSTRESS CAUTION

Stresses beyond those listed in Absolute Maximum Ratings may cause permanent damage to the device. Exposure to absolute maximum rating conditions for extended periods may affect reliability. Functional operation of the device at any conditions beyond those indicated in the Recommended Operating Conditions section is not implied.

ESD SENSITIVITY CAUTION

This integrated circuit can be damaged by ESD if you don't pay attention to ESD protection. SGMICRO recommends that all integrated circuits be handled with appropriate precautions. Failure to observe proper handling and installation procedures can cause damage. ESD damage can range from subtle performance degradation to complete device failure. Precision integrated circuits may be more susceptible to damage because very small parametric changes could cause the device not to meet its published specifications.

DISCLAIMER

SG Micro Corp reserves the right to make any change in circuit design, or specifications without prior notice.

PIN CONFIGURATIONS

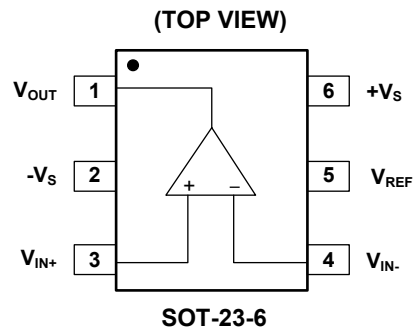
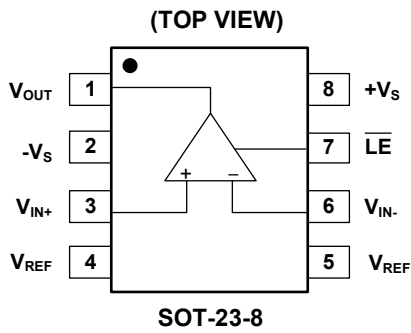
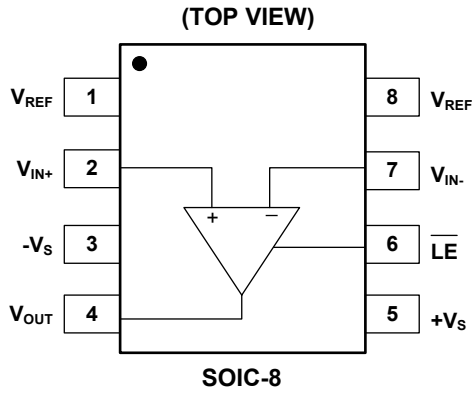

ELECTRICAL CHARACTERISTICS(At $T_A = +25^\circ\text{C}$, $+V_S = 1.8\text{V}$, $-V_S = 0\text{V}$, $V_{LE} = 1.8\text{V}$, $V_{CM} = +V_S/2$, unless otherwise noted.)

PARAMETER	SYMBOL	CONDITIONS	MIN	TYP	MAX	UNITS
Supply Current	I_S	$I_{OUT} = 0$		2.2	3.8	μA
Input Offset Voltage	V_{OS}	$V_{CM} = 0\text{V}$		0.5	3	mV
		$V_{CM} = 1.8\text{V}$		0.5	3	
Input Offset Average Drift				2		$\mu\text{V}/^\circ\text{C}$
Common Mode Rejection Ratio	CMRR	$V_{CM} = 0\text{V}$ to 1.8V	55	68		dB
Power Supply Rejection Ratio	PSRR	$V_S = 1.8\text{V}$ to 5.5V , $V_{CM} = 0\text{V}$	74	102		dB
Power Supply Ramp-Up Rate ⁽¹⁾			5			V/s
Latch Enable Pin High Input Voltage	V_{IH}		1.0			V
Latch Enable Pin Low Input Voltage	V_{IL}				0.25	V
Latch Enable Pin Bias Current	I_{IH} , I_{IL}	$V_{LE} = 0\text{V}$ or $V_{LE} = 1.8\text{V}$, $V_{CM} = 0\text{V}$		3		nA
Large Signal Voltage Gain	A_{VO}			100		dB
Output Swing High	V_{OH}	$I_{OUT} = 500\mu\text{A}$	1.617	1.675		V
		$I_{OUT} = 500\mu\text{A}$, $-40^\circ\text{C} \leq T_A \leq +85^\circ\text{C}$	1.572			
		$I_{OUT} = 1\text{mA}$	1.412	1.525		
		$I_{OUT} = 1\text{mA}$, $-40^\circ\text{C} \leq T_A \leq +85^\circ\text{C}$	1.330			
Output Swing Low	V_{OL}	$I_{OUT} = -500\mu\text{A}$		84	124	mV
		$I_{OUT} = -500\mu\text{A}$, $-40^\circ\text{C} \leq T_A \leq +85^\circ\text{C}$			163	
		$I_{OUT} = -1\text{mA}$		173	249	
		$I_{OUT} = -1\text{mA}$, $-40^\circ\text{C} \leq T_A \leq +85^\circ\text{C}$			347	
Output Current	I_{OUT}	Source	1.15	2		mA
		Source, $-40^\circ\text{C} \leq T_A \leq +85^\circ\text{C}$	1.0			
		Sink		-3.5	-2.0	
		Sink, $-40^\circ\text{C} \leq T_A \leq +85^\circ\text{C}$			-1.4	
Propagation Delay (High to Low)		Overdrive = 10mV		11.7		μs
		Overdrive = 100mV		5.6		
Propagation Delay (Low to High)		Overdrive = 10mV		24.2		μs
		Overdrive = 100mV		14.7		
Rise Time	t_{RISE}	Overdrive = 10mV, $C_L = 30\text{pF}$, $R_L = 1\text{M}\Omega$		168		ns
		Overdrive = 100mV, $C_L = 30\text{pF}$, $R_L = 1\text{M}\Omega$		174		
Fall Time	t_{FALL}	Overdrive = 10mV, $C_L = 30\text{pF}$, $R_L = 1\text{M}\Omega$		75		ns
		Overdrive = 100mV, $C_L = 30\text{pF}$, $R_L = 1\text{M}\Omega$		50		
Noise of V_{REF}		$f = 0.1\text{Hz}$ to 10Hz		0.3		mV_{P-P}
Voltage Reference						
Reference Voltage	V_{REF}	$I_{REF} = 0\text{mA}$	1.182	1.200	1.218	V
Reference Voltage Drift				42		$\mu\text{V}/^\circ\text{C}$
Reference Output Current (Source)				2		mA

ELECTRICAL CHARACTERISTICS (continued)(At $T_A = +25^\circ\text{C}$, $+V_S = 5\text{V}$, $-V_S = 0\text{V}$, $V_{\overline{\text{LE}}} = 5\text{V}$, $V_{\text{CM}} = +V_S/2$, unless otherwise noted.)

PARAMETER	SYMBOL	CONDITIONS	MIN	TYP	MAX	UNITS
Supply Current	I_S	$I_{\text{OUT}} = 0$		2.3	3.9	μA
Input Offset Voltage	V_{OS}	$V_{\text{CM}} = 0\text{V}$		0.5	3	mV
		$V_{\text{CM}} = 5\text{V}$		0.5	3	
Input Offset Average Drift				2		$\mu\text{V}/^\circ\text{C}$
Common Mode Rejection Ratio	CMRR	$V_{\text{CM}} = 0\text{V}$ to 5V	63	76		dB
Power Supply Rejection Ratio	PSRR	$V_S = 1.8\text{V}$ to 5.5V , $V_{\text{CM}} = 0\text{V}$	74	102		dB
Power Supply Ramp-Up Rate ⁽¹⁾			5			V/s
Latch Enable Pin High Input Voltage	V_{IH}		2			V
Latch Enable Pin Low Input Voltage	V_{IL}				0.8	V
Latch Enable Pin Bias Current	$I_{\text{IH}}, I_{\text{IL}}$	$V_{\overline{\text{LE}}} = 0\text{V}$ or $V_{\overline{\text{LE}}} = 5\text{V}$, $V_{\text{CM}} = 0\text{V}$		60		nA
Latch Propagation Delay	t_{LPD}	$V_S = 3\text{V}$		90		ns
Large Signal Voltage Gain	A_{VO}			110		dB
Output Swing High	V_{OH}	$I_{\text{OUT}} = 500\mu\text{A}$	4.935	4.952		V
		$I_{\text{OUT}} = 500\mu\text{A}$, $-40^\circ\text{C} \leq T_A \leq +85^\circ\text{C}$	4.926			
		$I_{\text{OUT}} = 1\text{mA}$	4.874	4.904		
		$I_{\text{OUT}} = 1\text{mA}$, $-40^\circ\text{C} \leq T_A \leq +85^\circ\text{C}$	4.855			
Output Swing Low	V_{OL}	$I_{\text{OUT}} = -500\mu\text{A}$		54	72	mV
		$I_{\text{OUT}} = -500\mu\text{A}$, $-40^\circ\text{C} \leq T_A \leq +85^\circ\text{C}$			79	
		$I_{\text{OUT}} = -1\text{mA}$		106	140	
		$I_{\text{OUT}} = -1\text{mA}$, $-40^\circ\text{C} \leq T_A \leq +85^\circ\text{C}$			154	
Output Current	I_{OUT}	Source	14.0	18		mA
		Source, $-40^\circ\text{C} \leq T_A \leq +85^\circ\text{C}$	10.5			
		Sink		-18	-15.5	
		Sink, $-40^\circ\text{C} \leq T_A \leq +85^\circ\text{C}$			-12.5	
Propagation Delay (High to Low)		Overdrive = 10mV		12.7		μs
		Overdrive = 100mV		5.6		
Propagation Delay (Low to High)		Overdrive = 10mV		38.1		μs
		Overdrive = 100mV		29.5		
Rise Time	t_{RISE}	Overdrive = 10mV, $C_L = 30\text{pF}$, $R_L = 1\text{M}\Omega$		39		ns
		Overdrive = 100mV, $C_L = 30\text{pF}$, $R_L = 1\text{M}\Omega$		40		
Fall Time	t_{FALL}	Overdrive = 10mV, $C_L = 30\text{pF}$, $R_L = 1\text{M}\Omega$		33		ns
		Overdrive = 100mV, $C_L = 30\text{pF}$, $R_L = 1\text{M}\Omega$		30		
Noise of V_{REF}		$f = 0.1\text{Hz}$ to 10Hz		0.32		$\text{mV}_{\text{P-P}}$
Voltage Reference						
Reference Voltage	V_{REF}	$I_{\text{REF}} = 0\text{mA}$	1.182	1.200	1.218	V
Reference Voltage Drift				41		$\mu\text{V}/^\circ\text{C}$
Reference Output Current (Source)				2		mA

NOTE:

1. If the power supply ramp-up rate is lower than 5V/s, the reference voltage output is not guaranteed to start up.

TYPICAL PERFORMANCE CHARACTERISTICS

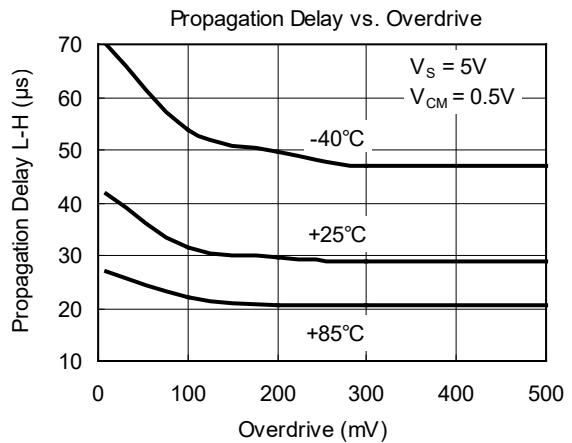
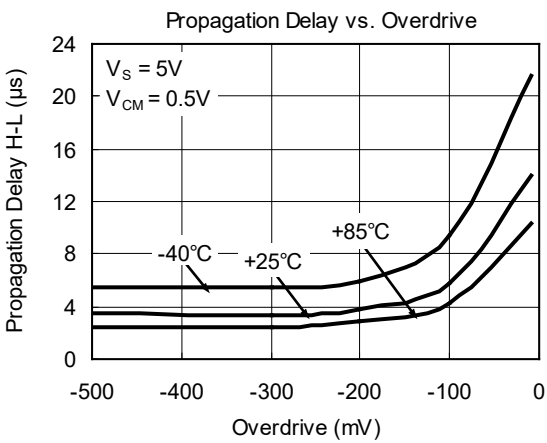
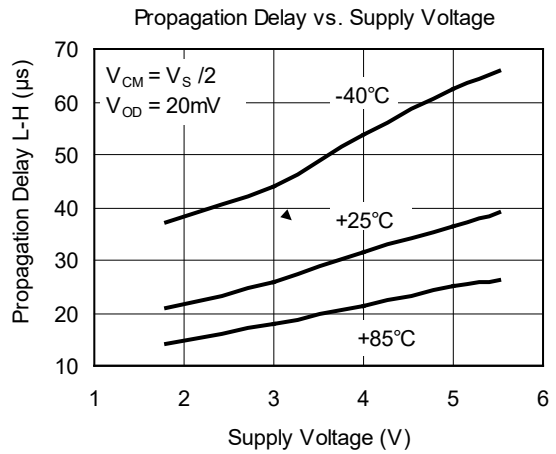
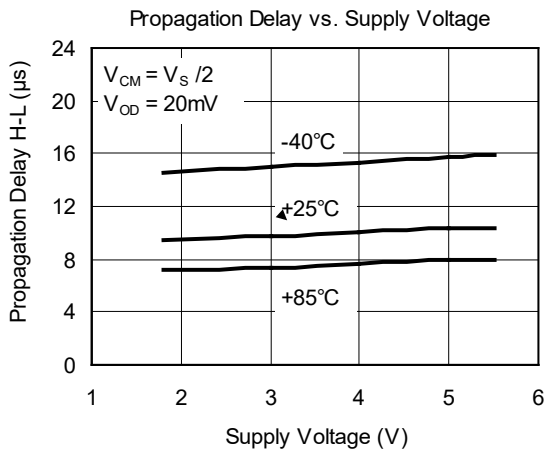
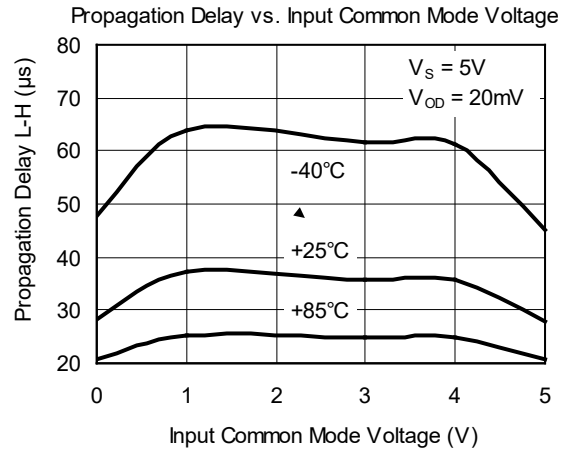
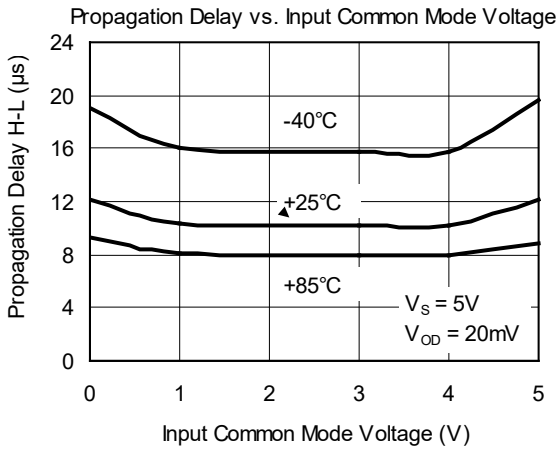

TYPICAL PERFORMANCE CHARACTERISTICS (continued)

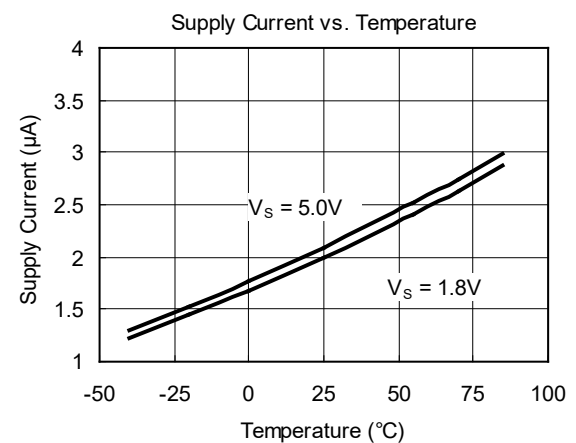
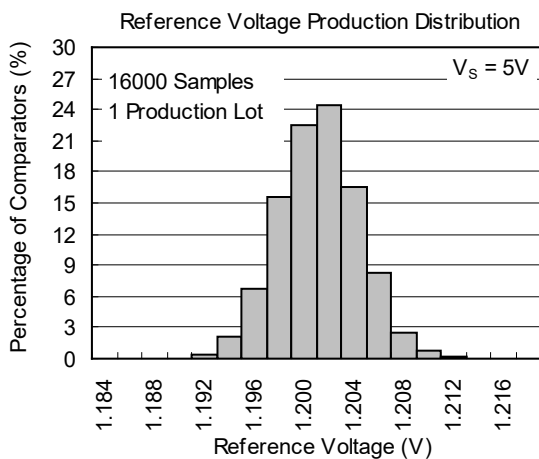
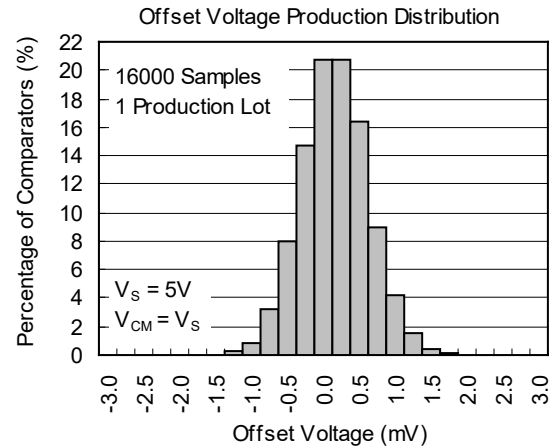
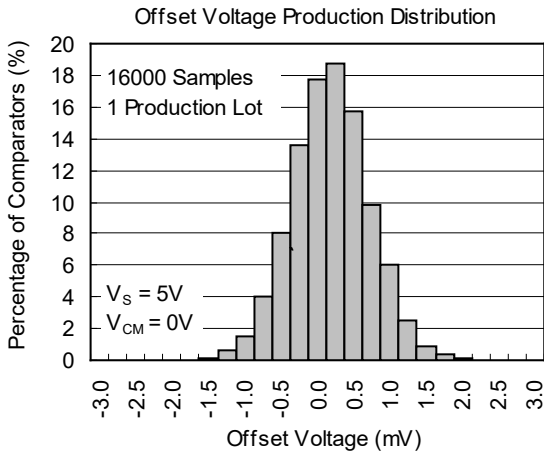
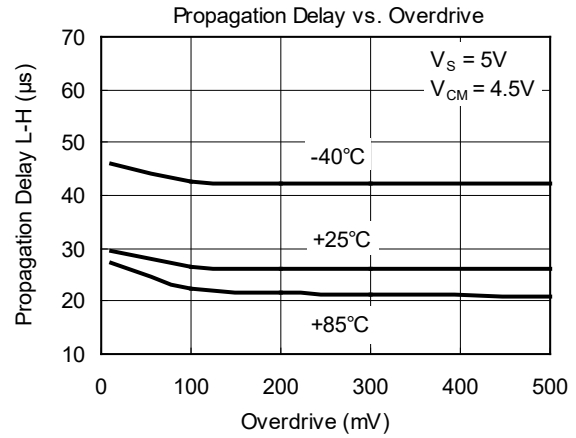
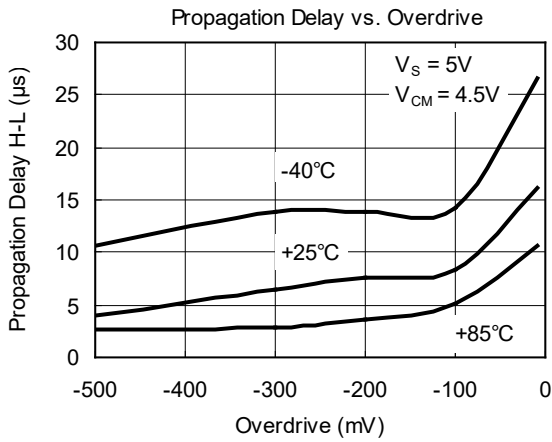

TYPICAL PERFORMANCE CHARACTERISTICS (continued)

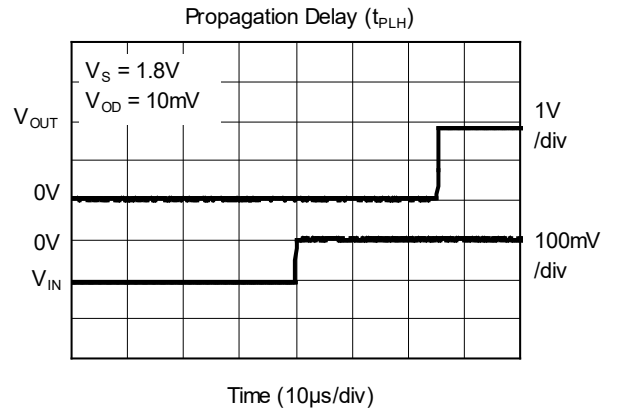
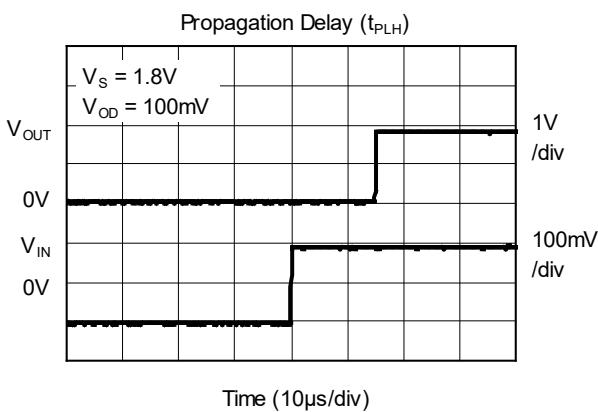
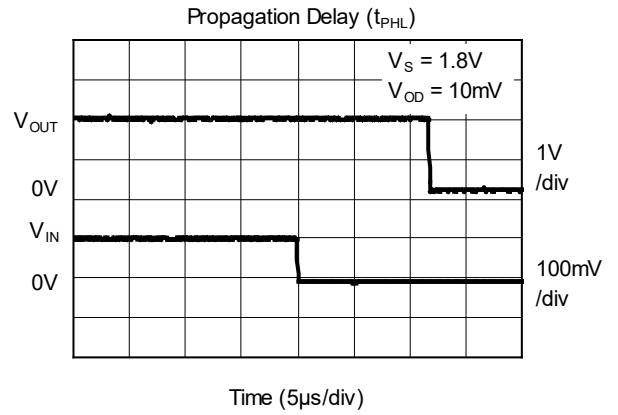
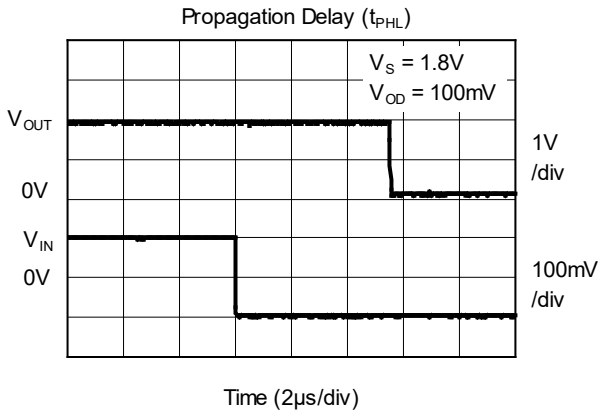
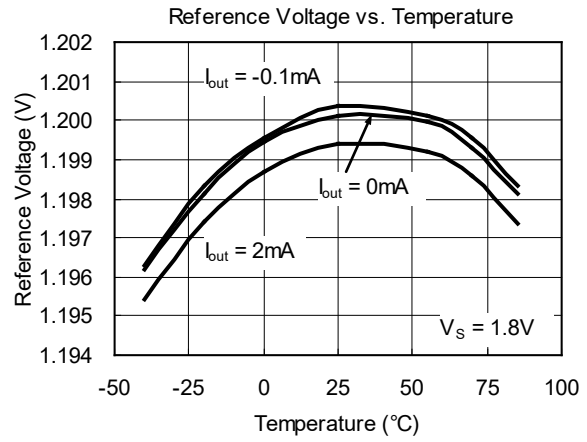
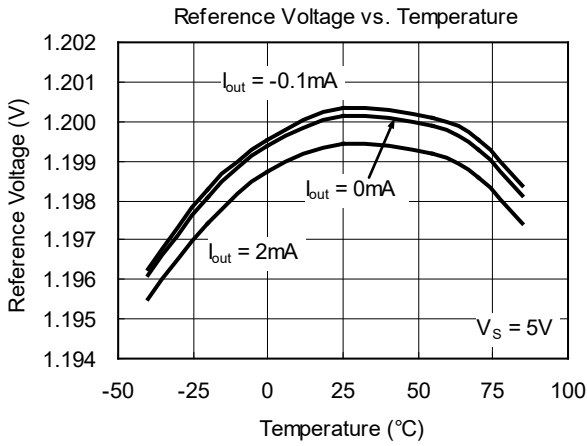

TYPICAL PERFORMANCE CHARACTERISTICS (continued)

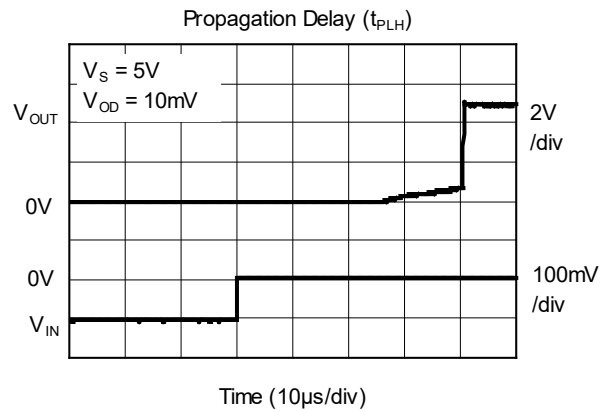
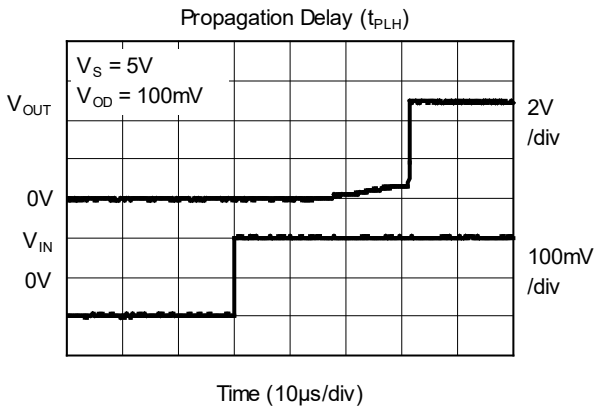
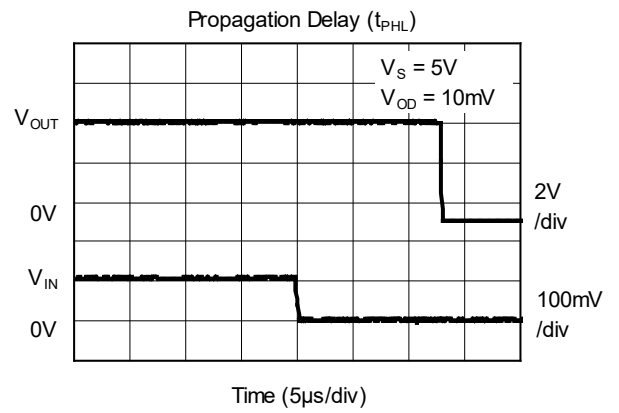
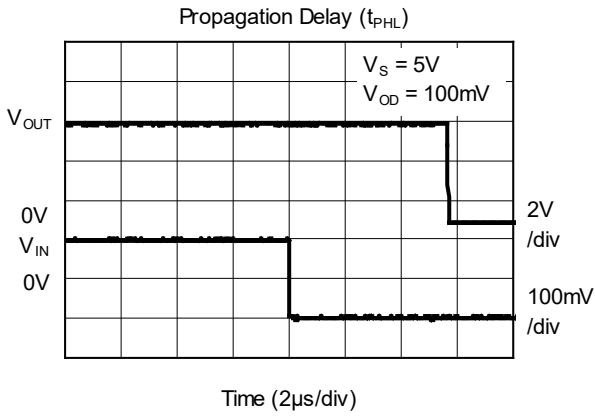

TIMING DIAGRAM

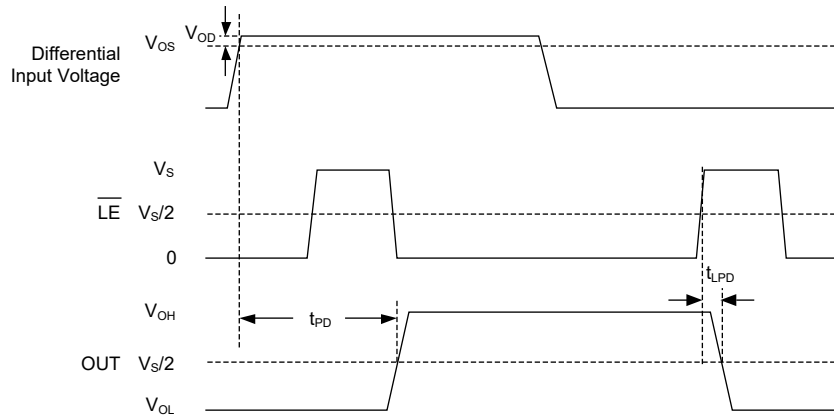

Figure 1. Timing Diagram with Latch Operator

REVISION HISTORY

NOTE: Page numbers for previous revisions may differ from page numbers in the current version.

DECEMBER 2013 – REV.A to REV.A.1	Page
Added Electrical Characteristics section	5
Added Timing Diagram section	10

Changes from Original (NOVEMBER 2012) to REV.A	Page
Changed from product preview to production data	All

PACKAGE OUTLINE DIMENSIONS

SOT-23-6

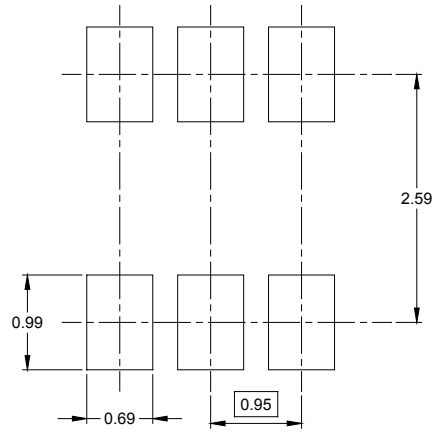
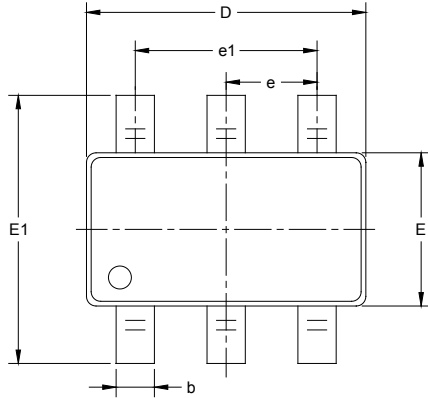

RECOMMENDED LAND PATTERN (Unit: mm)

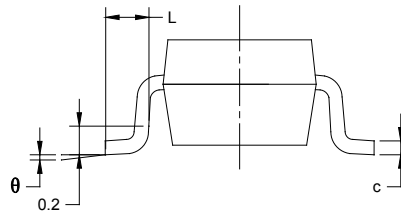
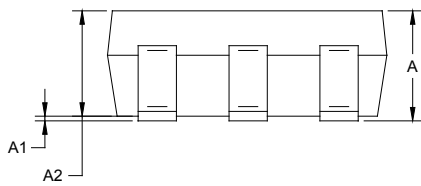

Symbol	Dimensions In Millimeters		Dimensions In Inches	
	MIN	MAX	MIN	MAX
A	1.050	1.250	0.041	0.049
A1	0.000	0.100	0.000	0.004
A2	1.050	1.150	0.041	0.045
b	0.300	0.500	0.012	0.020
c	0.100	0.200	0.004	0.008
D	2.820	3.020	0.111	0.119
E	1.500	1.700	0.059	0.067
E1	2.650	2.950	0.104	0.116
e	0.950 BSC		0.037 BSC	
e1	1.900 BSC		0.075 BSC	
L	0.300	0.600	0.012	0.024
θ	0°	8°	0°	8°

PACKAGE OUTLINE DIMENSIONS

SOT-23-8

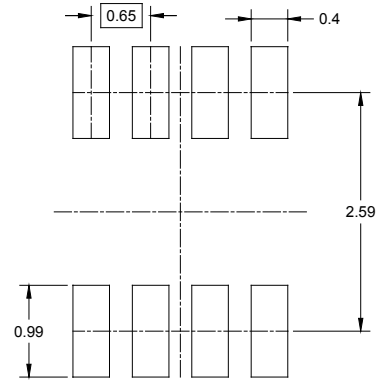
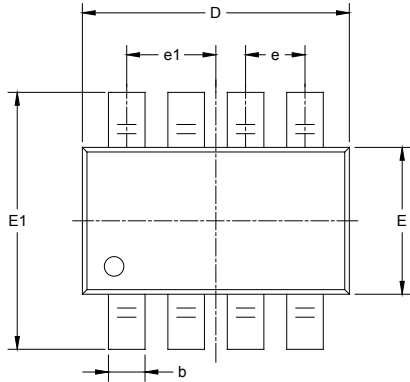

RECOMMENDED LAND PATTERN (Unit: mm)

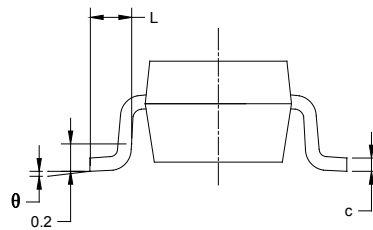
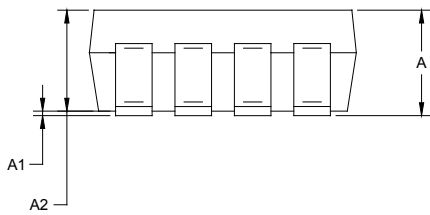

Symbol	Dimensions In Millimeters		Dimensions In Inches	
	MIN	MAX	MIN	MAX
A	1.050	1.250	0.041	0.049
A1	0.000	0.100	0.000	0.004
A2	1.050	1.150	0.041	0.045
b	0.300	0.500	0.012	0.020
c	0.100	0.200	0.004	0.008
D	2.820	3.020	0.111	0.119
E	1.500	1.700	0.059	0.067
E1	2.650	2.950	0.104	0.116
e	0.650 BSC		0.026 BSC	
e1	0.975 BSC		0.038 BSC	
L	0.300	0.600	0.012	0.024
θ	0°	8°	0°	8°

PACKAGE OUTLINE DIMENSIONS

SOIC-8

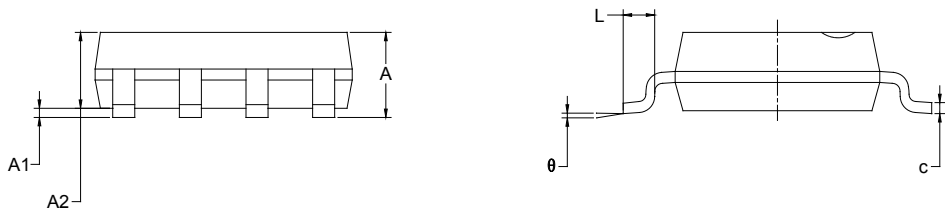
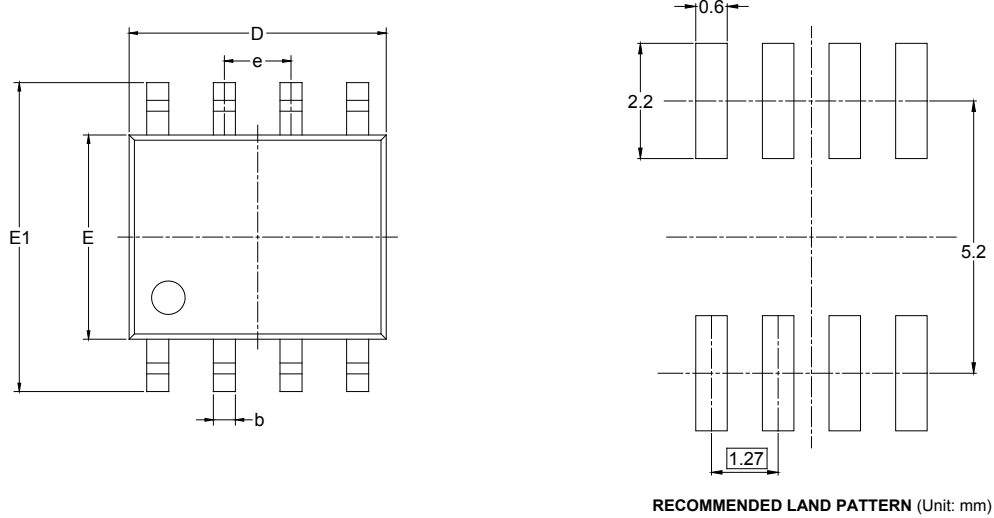

Symbol	Dimensions In Millimeters		Dimensions In Inches	
	MIN	MAX	MIN	MAX
A	1.350	1.750	0.053	0.069
A1	0.100	0.250	0.004	0.010
A2	1.350	1.550	0.053	0.061
b	0.330	0.510	0.013	0.020
c	0.170	0.250	0.006	0.010
D	4.700	5.100	0.185	0.200
E	3.800	4.000	0.150	0.157
E1	5.800	6.200	0.228	0.244
e	1.27 BSC		0.050 BSC	
L	0.400	1.270	0.016	0.050
θ	0°	8°	0°	8°

PACKAGE INFORMATION

TAPE AND REEL INFORMATION

REEL DIMENSIONS



TAPE DIMENSIONS



NOTE: The picture is only for reference. Please make the object as the standard.

KEY PARAMETER LIST OF TAPE AND REEL

Package Type	Reel Diameter	Reel Width W1 (mm)	A0 (mm)	B0 (mm)	K0 (mm)	P0 (mm)	P1 (mm)	P2 (mm)	W (mm)	Pin1 Quadrant
SOT-23-6	7"	9.5	3.17	3.23	1.37	4.0	4.0	2.0	8.0	Q3
SOT-23-8	7"	9.5	3.17	3.23	1.37	4.0	4.0	2.0	8.0	Q3
SOIC-8	13"	12.4	6.40	5.40	2.10	4.0	8.0	2.0	12.0	Q1

DD0001

PACKAGE INFORMATION

CARTON BOX DIMENSIONS



NOTE: The picture is only for reference. Please make the object as the standard.

KEY PARAMETER LIST OF CARTON BOX

Reel Type	Length (mm)	Width (mm)	Height (mm)	Pizza/Carton
7" (Option)	368	227	224	8
7"	442	410	224	18
13"	386	280	370	5

DD0002