

GENERAL DESCRIPTION

The SGM2590 and SGM2590D are single channel power distribution switches. The switch is controlled by the EN pin and operates from 2.5V to 6V supply voltage. It can be used in USB power distribution applications.

The SGM2590 and SGM2590D integrate programmable current limit to protect the upstream power supply from damage during over-current or short-circuit condition. It also has the function of over-temperature protection.

The device is designed with soft-start circuit to cope with inrush currents when large capacitive loads are connected.

The SGM2590D further reduces the total solution size by integrating a 47Ω pull-down resistor for output discharge when the switch is shut down by EN.

SGM2590 and SGM2590D are available in a Green SOT-23-5 package.

APPLICATIONS

General Purpose Power Switching
 USB Bus/Self-Powered Hub
 USB Peripheral
 ACPI Power Distribution
 Smart Phone
 LCD TV

FEATURES

- High-side N-MOSFET
- On-Resistance: 65mΩ (TYP)
- Programmable Current Limit Range: 0.1A to 3A
1.5A at $R_{ILIM} = 4.53k\Omega$
- Input Voltage Range: 2.5V to 6V
- Quiescent Current: 27μA (TYP)
- Shutdown Current: 0.28μA (TYP)
- Soft-Start Function
- Over-Temperature Protection
- Under-Voltage Lockout Protection for VIN
- No Reversed Leakage Current (Reverse Blocking)
- Quick Output Discharge (SGM2590D Only)
- 1.2MΩ Pull-Down Resistor at EN Pin
- Available in a Green SOT-23-5 Package

TYPICAL APPLICATION

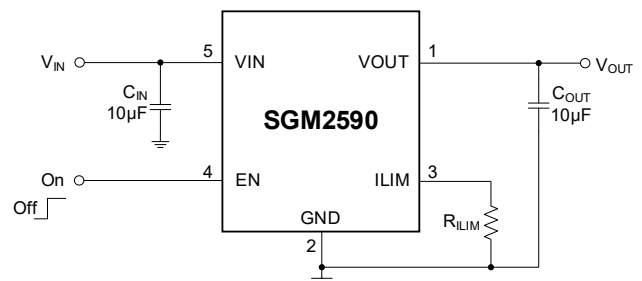
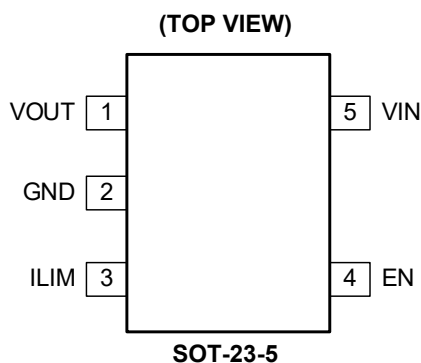

Figure 1. Typical Application Circuit

PIN CONFIGURATION



PIN DESCRIPTION

PIN	NAME	FUNCTION
1	VOUT	Output Voltage.
2	GND	Ground.
3	ILIM	Current Limit Programming Pin. Connect a resistor R_{ILIM} from this pin to GND to set the overload current limit threshold: $I_{LIM} = \frac{6612}{R_{ILIM}^{0.982}} \text{ (A)}$ If the ILIM pin is connected to GND directly, the current limit function is not available.
4	EN	Chip Enable. Active-high for SGM2590 and SGM2590D. They have integrated a 1.2M Ω pull-down resistor at this pin.
5	VIN	Power Input Voltage.

ELECTRICAL CHARACTERISTICS

(T_J = -40°C to +125°C, typical values are at T_J = +25°C, V_{IN} = 5V, unless otherwise noted.)

PARAMETER	SYMBOL	CONDITIONS	MIN	TYP	MAX	UNITS
Input Voltage Range	V _{IN}		2.5		6	V
Under-Voltage Lockout Threshold	V _{UVLO}	V _{IN} rising		2.23	2.40	V
Under-Voltage Lockout Threshold Hysteresis	V _{UVLO_HYS}	V _{IN} falling		100		mV
Quiescent Current	I _Q	Switch on, V _{OUT} = open		27	60	μA
Shutdown Current	I _{SD}	Switch off, V _{OUT} = open		0.28	5	μA
Output Leakage Current	I _{LEAKAGE}	Switch off, V _{OUT} = 6V, V _{IN} = 0V, T _J = -40°C to +85°C		0.21	1.5	μA
		Switch off, V _{OUT} = 6V, V _{IN} = 0V, T _J = -40°C to +125°C		0.21	6	
Enable Input Threshold	V _{IH}		1.2			V
	V _{IL}	T _J = -40°C to +85°C			0.4	
			T _J = -40°C to +125°C			0.3
Pull-Down Resistor at EN Pin	R _{PULL_DOWN}			1.2		MΩ
On-Resistance	R _{DSON}	I _{OUT} = 200mA, T _J = -40°C to +85°C		65	98	mΩ
		I _{OUT} = 200mA, T _J = -40°C to +125°C		65	125	
Output Turn-On Delay Time	t _{ON}	R _L = 100Ω, C _{OUT} = 0.1μF		1.1		ms
Output Turn-Off Delay Time	t _{OFF}	R _L = 100Ω, C _{OUT} = 0.1μF, SGM2590		32		μs
		R _L = 100Ω, C _{OUT} = 0.1μF, SGM2590D		27		
Output Turn-On Rise Time	t _R	R _L = 100Ω, C _{OUT} = 0.1μF		1.3		ms
Output Turn-Off Fall Time	t _F	R _L = 100Ω, C _{OUT} = 0.1μF, SGM2590		27		μs
		R _L = 100Ω, C _{OUT} = 0.1μF, SGM2590D		13		
Current Limit Threshold	I _{LIM}	R _{LIM} = 68kΩ, T _J = -40°C to +125°C	45	105	150	mA
		R _{LIM} = 68kΩ, T _J = +25°C	50	105	140	
		R _{LIM} = 38kΩ, T _J = -40°C to +125°C	115	185	255	
		R _{LIM} = 38kΩ, T _J = +25°C	120	185	250	
		R _{LIM} = 17kΩ, T _J = -40°C to +125°C	320	405	470	
		R _{LIM} = 17kΩ, T _J = +25°C	330	405	465	
		R _{LIM} = 6.8kΩ, T _J = -40°C to +125°C	870	1005	1130	
		R _{LIM} = 6.8kΩ, T _J = +25°C	895	1005	1115	
		R _{LIM} = 4.53kΩ, T _J = -40°C to +125°C	1310	1495	1675	
		R _{LIM} = 4.53kΩ, T _J = +25°C	1340	1495	1655	
		R _{LIM} = 3.4kΩ, T _J = -40°C to +125°C	1735	1980	2210	
		R _{LIM} = 3.4kΩ, T _J = +25°C	1780	1980	2185	
		R _{LIM} = 2.7kΩ, T _J = -40°C to +125°C	2260	2480	2675	
		R _{LIM} = 2.7kΩ, T _J = +25°C	2310	2480	2650	
		R _{LIM} = 2.3kΩ, T _J = -40°C to +125°C	2660	2885	3110	
R _{LIM} = 2.3kΩ, T _J = +25°C	2690	2885	3090			
Reverse Protection Threshold	V _{REV}	V _{OUT} -V _{IN} rising	7	24	39	mV
Reverse Protection Threshold Hysteresis	V _{REV_HYS}	V _{OUT} falling		16		mV
V _{OUT} Shutdown Discharge Resistance (SGM2590D Only)	R _{DIS}	Switch off, sink 2mA into OUT		47		Ω
Thermal Shutdown Temperature	T _{SD}	T _J increasing		156		°C
Thermal Shutdown Hysteresis	T _{HYS}			55		°C

TYPICAL PERFORMANCE CHARACTERISTICS

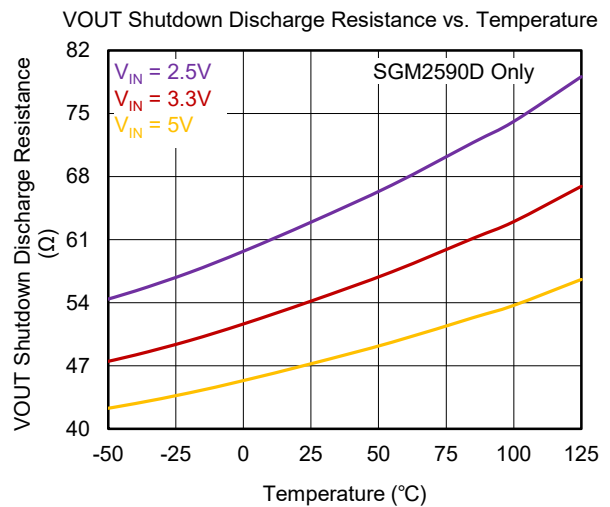
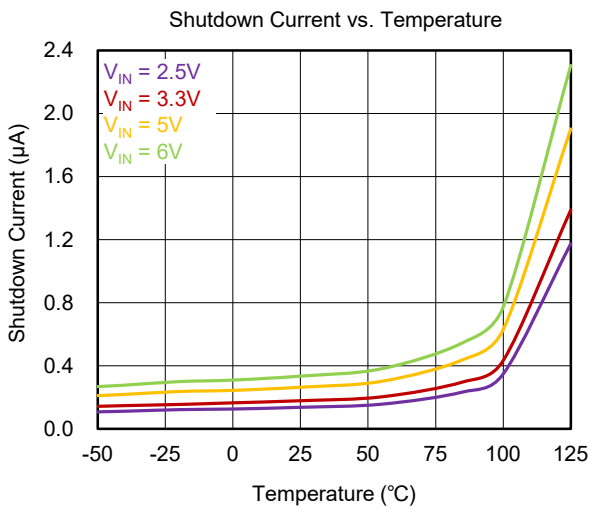
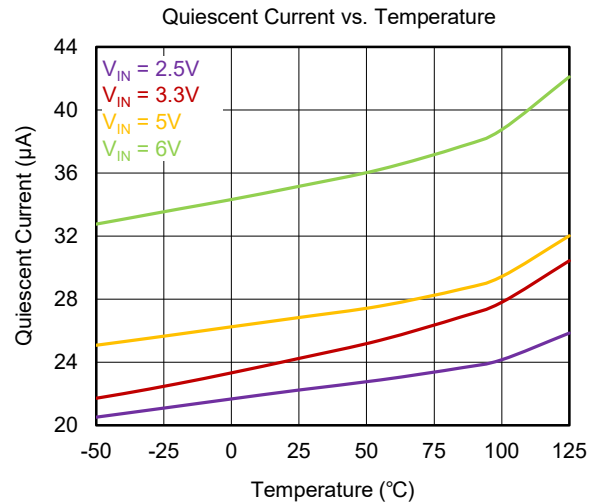
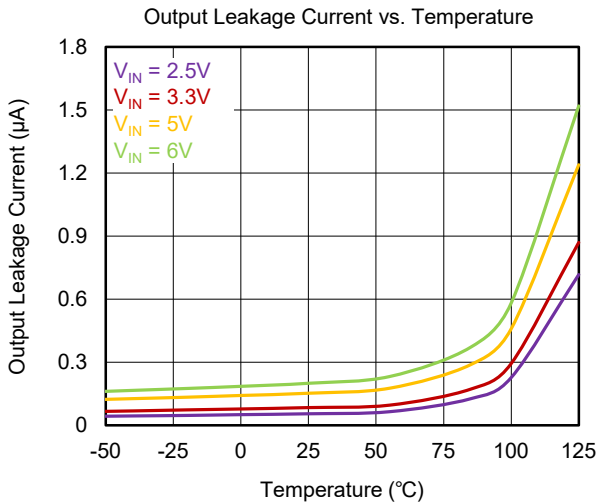
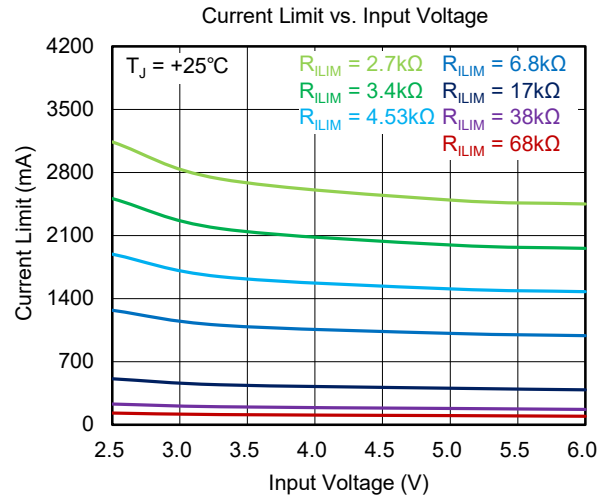
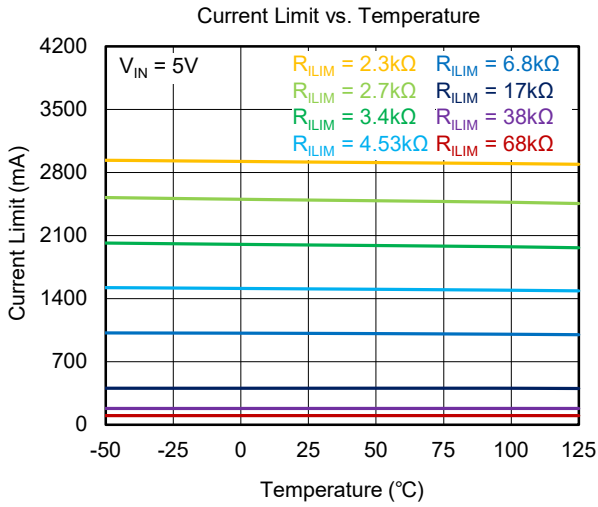

TYPICAL PERFORMANCE CHARACTERISTICS (continued)

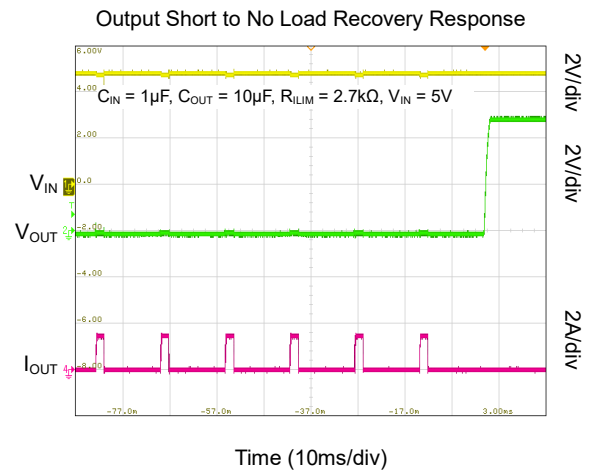
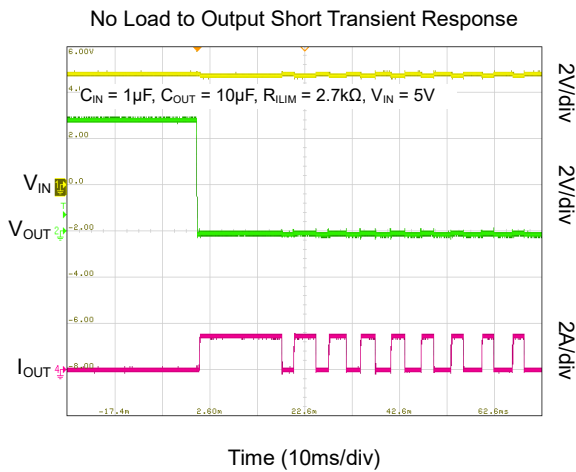
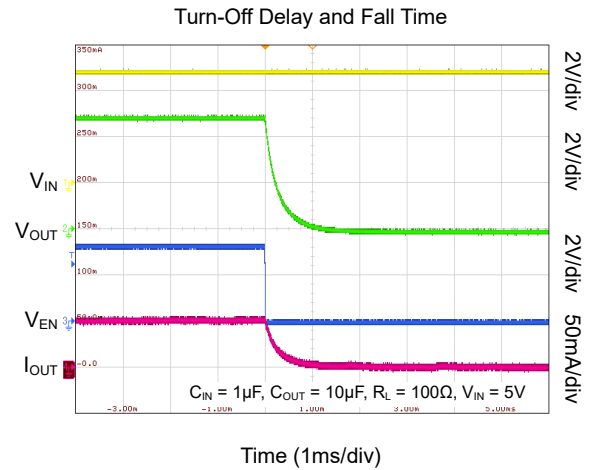
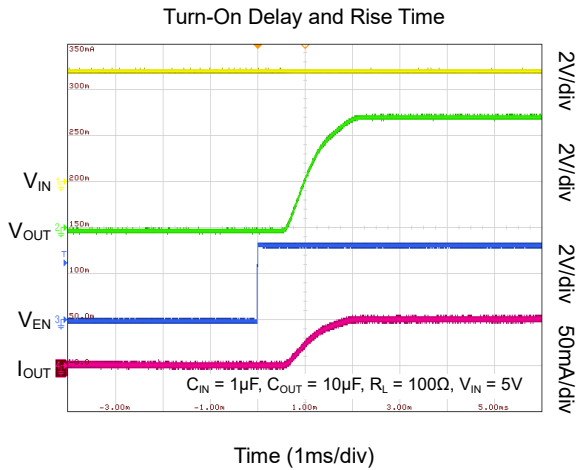
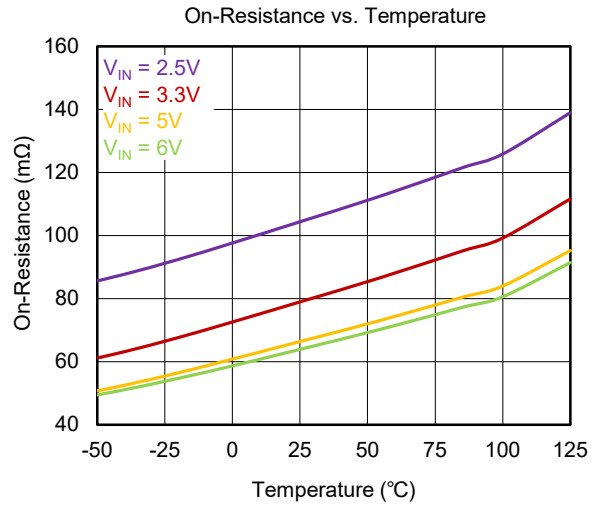
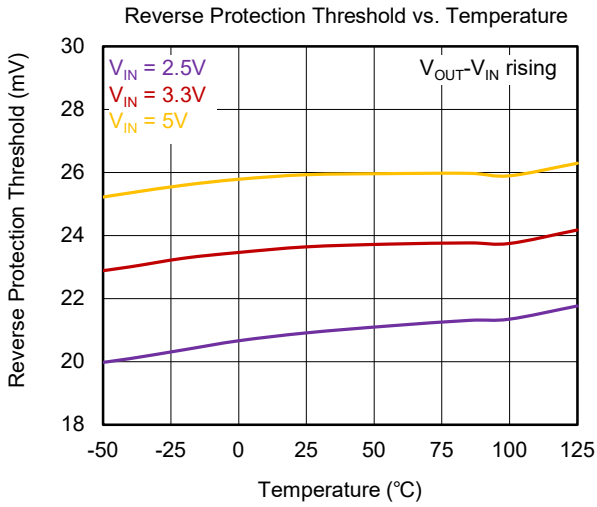

FUNCTIONAL BLOCK DIAGRAM

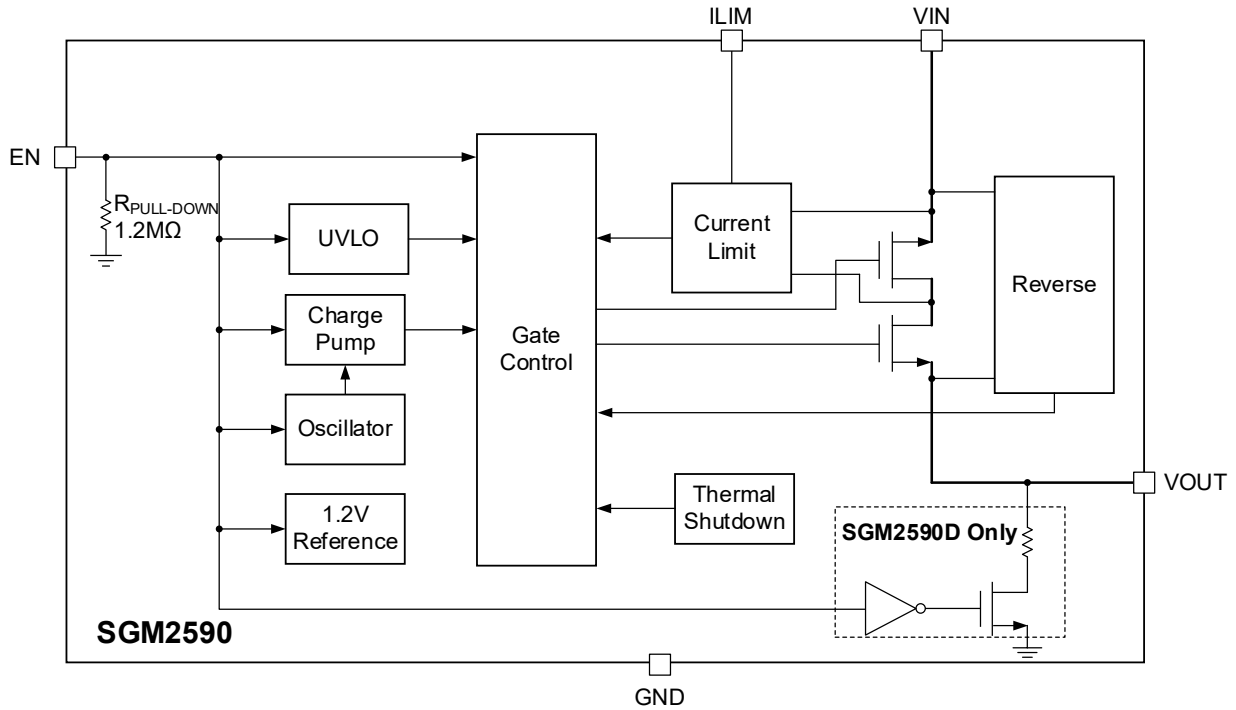

Figure 2. SGM2590 Block Diagram

TIMING DIAGRAM

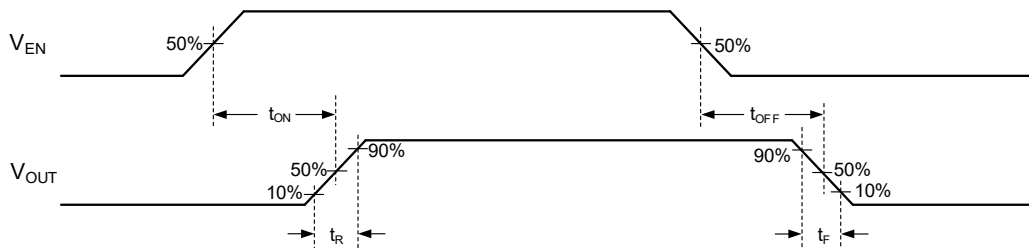

Figure 3. Switch Turn-On and Turn-Off Times

DETAILED DESCRIPTION

Input and Output

VIN should be connected to the power source that is the power supply of the internal logic circuitry and loads. Normally, load current flows from VIN to VOUT. The output MOSFET and driver circuit are designed to allow the voltage of VOUT is higher than VIN, when the device is turned off.

Thermal Shutdown (TSD)

The thermal shutdown threshold is +156°C with 55°C hysteresis.

Soft-Start

The soft-start feature is used to limit inrush current during start-up or hot-plug events so that the device can cope with inrush current when connected to large capacitive loads.

Under-Voltage Lockout (UVLO)

If the voltage on the VIN pin falls below its under-voltage lockout threshold, the device will be disabled. The device resumes operation when the power supply goes back above the UVLO threshold.

Current Limit and Short-Circuit Protection

The current limit protection circuit is designed to protect the upstream power supply by limiting the output current to the current limit threshold set by the R_{ILIM} from ILIM to GND.

If the short-circuit state persists, the device will cycle on and off under thermal protection as a result of power dissipation.

Reverse-Voltage Protection

When the output voltage exceeds the input voltage by 24mV (TYP), the device turns off the internal N-MOSFET to avoid the reverse current from the output to input. Its hysteresis voltage is 16mV (TYP).

Output Discharge

The SGM2590D integrates the output discharge feature. When the EN pin is pulled low (below V_{IL}), a discharge resistance with a typical value of 47Ω is connected between the VOUT and GND. This resistance pulls down the output and prevents it from floating when the device is disabled.

APPLICATION INFORMATION

Current Limit Programming

An external resistor (R_{ILIM}) placed between the ILIM pin and GND sets the switch current limit threshold (I_{LIM}). The ILIM pin voltage is regulated by an internal control loop. The current limit threshold is proportional to the current pulled from the ILIM pin by the resistor. Use short trace routes for the R_{ILIM} on the PCB to minimize the impact of parasitics and noise on the accuracy of the current limit setting.

$$I_{LIM} = \frac{6612}{R_{ILIM}^{0.982}} \quad (1)$$

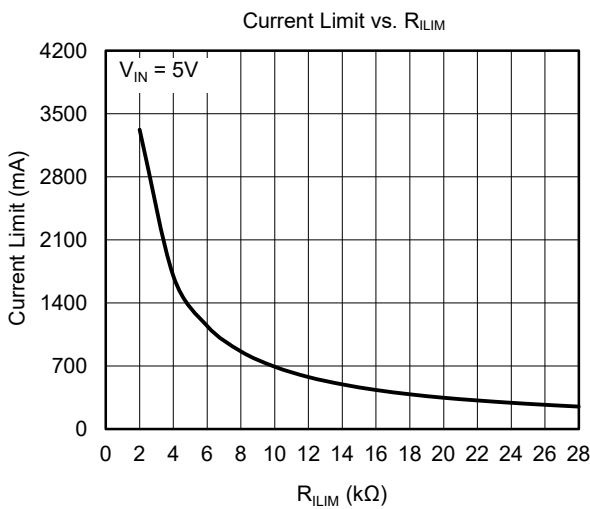

Figure 4. Current Limit Threshold (I_{LIM}) vs. Current Limit Programming Resistor (R_{ILIM})

Power Dissipation

Assuming a given ambient temperature and an output current, the maximum allowable power dissipation is calculated by:

$$P_{D(MAX)} = \frac{T_{J(MAX)} - T_A}{\theta_{JA}} \quad (2)$$

where:

- ♦ $P_{D(MAX)}$ is the maximum power dissipation.
- ♦ $T_{J(MAX)}$ is the maximum operating junction temperature.
- ♦ T_A is the operating ambient temperature.
- ♦ θ_{JA} is junction to air thermal impedance.

Please note that the thermal vias are placed under the exposed pad of the device, thus allowing for thermal dissipation away from the device.

Supply Filter Capacitor

It is recommended to use a 10μF capacitor between VIN and GND close to the device pins. It can limit the voltage drop of the input supply. Larger C_{IN} can reduce voltage dip in high current applications. Without an input capacitor, short-circuit at the output will cause the input voltage to ring, which may destroy the chip's internal circuitry when the input transient voltage exceeds the absolute maximum supply voltage (6.5V).

Output Filter Capacitor

To reduce EMI, improve the transient performance, and minimize negative effects of resistance and inductance between the bypass capacitor and the downstream connector, a low-ESR 10μF ceramic capacitor between VOUT and GND standard bypass methods are recommended. If the output port is connected to the load through a long cable, the parasitic inductance of the cable may cause voltage to ring, whose negative ringing may damage the chip, so an anti-parallel Schottky diode such as BAT54 is recommended to connect in parallel with the output.

PCB Layout Guide

A reasonable PCB layout is critical to the stable performance of the device. For best results, follow the guidelines below.

- ♦ Keep the power traces as short and wide as possible, and use at least 2 ounces of copper.
- ♦ Placing a ground plane under all circuits to reduce resistance and inductance will improve DC and transient performances.
- ♦ Ensure that the input decoupling capacitors on VIN have a minimal trace length to VIN and GND.
- ♦ Place the output capacitors as close to the device as possible to minimize the effect of PCB parasitic inductance.

REVISION HISTORY

NOTE: Page numbers for previous revisions may differ from page numbers in the current version.

NOVEMBER 2023 – REV.A to REV.A.1	Page
Updated Electrical Characteristics section	4

Changes from Original (NOVEMBER 2023) to REV.A	Page
Changed from product preview to production data.....	All

PACKAGE INFORMATION

PACKAGE OUTLINE DIMENSIONS

SOT-23-5

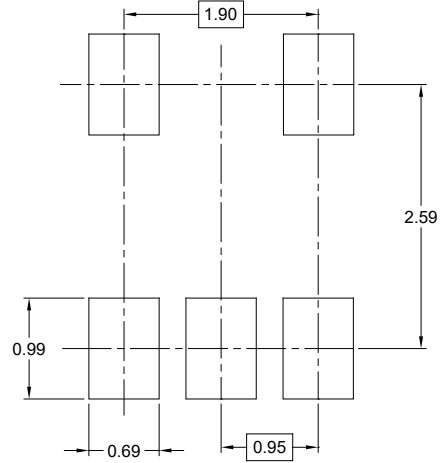
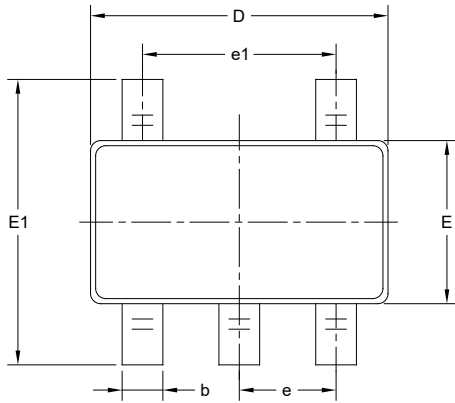

RECOMMENDED LAND PATTERN (Unit: mm)

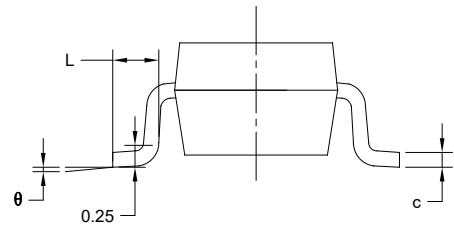
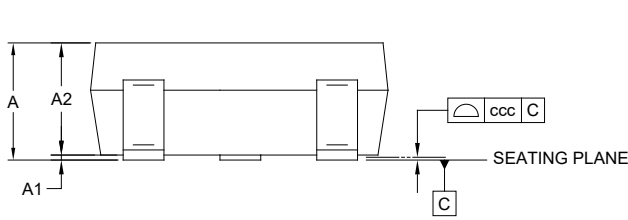

Symbol	Dimensions In Millimeters		
	MIN	MOD	MAX
A	-	-	1.450
A1	0.000	-	0.150
A2	0.900	-	1.300
b	0.300	-	0.500
c	0.080	-	0.220
D	2.750	-	3.050
E	1.450	-	1.750
E1	2.600	-	3.000
e	0.950 BSC		
e1	1.900 BSC		
L	0.300	-	0.600
θ	0°	-	8°
ccc	0.100		

NOTES:

1. This drawing is subject to change without notice.
2. The dimensions do not include mold flashes, protrusions or gate burrs.
3. Reference JEDEC MO-178.

PACKAGE INFORMATION

TAPE AND REEL INFORMATION

REEL DIMENSIONS



TAPE DIMENSIONS



NOTE: The picture is only for reference. Please make the object as the standard.

KEY PARAMETER LIST OF TAPE AND REEL

Package Type	Reel Diameter	Reel Width W1 (mm)	A0 (mm)	B0 (mm)	K0 (mm)	P0 (mm)	P1 (mm)	P2 (mm)	W (mm)	Pin1 Quadrant
SOT-23-5	7"	9.5	3.20	3.20	1.40	4.0	4.0	2.0	8.0	Q3

DD0001

PACKAGE INFORMATION

CARTON BOX DIMENSIONS



NOTE: The picture is only for reference. Please make the object as the standard.

KEY PARAMETER LIST OF CARTON BOX

Reel Type	Length (mm)	Width (mm)	Height (mm)	Pizza/Carton
7" (Option)	368	227	224	8
7"	442	410	224	18

DD0002