



# SGM7224X

## High-Speed USB 2.0 (480Mbps) DPDT Analog Switch

### GENERAL DESCRIPTION

The SGM7224X is a DPDT (double-pole/double-throw) analog switch. It operates from a 1.8V to 5.5V single power supply. Each switch of the SGM7224X is bidirectional, which can ensure that the high speed signals have little or no attenuation at the outputs.

Other features include high speed, low bit-to-bit skew and wide bandwidth. These high performances make it very suitable for multiple applications, such as cellular phones and computer peripherals, etc.

The SGM7224X has power-off and power-on protections. Because of the special circuitry on the D+/D- pins, the device will not be damaged even if  $V_{BUS}$  short-circuit occurs during data transmission. In addition, it can prevent accidental from leaking and ensure system reliability under power-down and over-voltage conditions.

The SGM7224X is available in Green MSOP-10 and UTQFN-1.8×1.4-10L packages. It operates over an ambient temperature range of -40°C to +125°C.

### FEATURES

- **Single Supply Voltage Range: 1.8V to 5.5V**
- **On-Resistance: 6Ω (TYP) at 3V**
- **-3dB Bandwidth: 850MHz**
- **Low Bit-to-Bit Skew: 0.5ns (TYP)**
- **Fast Switching Times at 3.3V:**
  - $t_{ON}$ : 28ns
  - $t_{OFF}$ : 18ns
- **Off-Isolation: -22dB ( $R_L = 50\Omega$ ,  $f = 250\text{MHz}$ )**
- **Low Crosstalk: -26dB ( $R_L = 50\Omega$ ,  $f = 250\text{MHz}$ )**
- **Power-Off and Power-On Protections**
- **Rail-to-Rail Input and Output Operation**
- **Break-Before-Make Switching**
- **-40°C to +125°C Operating Temperature Range**
- **Available in Green UTQFN-1.8×1.4-10L and MSOP-10 Packages**

### APPLICATIONS

Cellular Phones  
Digital Cameras  
Portable Equipment  
Computer Peripherals  
Battery-Powered Systems  
Routes Signals for USB 2.0 Full-Speed

**PACKAGE/ORDERING INFORMATION**

MODEL	PACKAGE DESCRIPTION	SPECIFIED TEMPERATURE RANGE	ORDERING NUMBER	PACKAGE MARKING	PACKING OPTION
SGM7224X	UTQFN-1.8x1.4-10L	-40°C to +125°C	SGM7224XUWQ10G/TR	R9E XXX	Tape and Reel, 3000
	MSOP-10	-40°C to +125°C	SGM7224XMS10G/TR	SGM7224 XMS10 XXXXX	Tape and Reel, 4000

**MARKING INFORMATION**

NOTE: XXX = Date Code and Trace Code. XXXXX = Date Code, Trace Code and Vendor Code.

**UTQFN-1.8x1.4-10L**

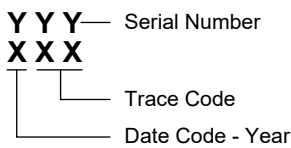

**MSOP-10**

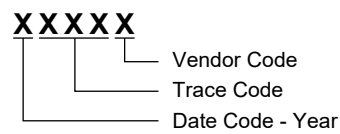

Green (RoHS & HSF): SG Micro Corp defines "Green" to mean Pb-Free (RoHS compatible) and free of halogen substances. If you have additional comments or questions, please contact your SGMICRO representative directly.

**ABSOLUTE MAXIMUM RATINGS**

V <sub>CC</sub> to GND .....	0V to 6V
Analog, Digital Voltage Range .....	-0.3V to (V <sub>CC</sub> + 0.3V)
Continuous Current HSDn or Dn .....	±50mA
Peak Current HSDn or Dn .....	±100mA
Junction Temperature .....	+150°C
Storage Temperature Range .....	-65°C to +150°C
Lead Temperature (Soldering, 10s) .....	+260°C
ESD Susceptibility	
HBM .....	4000V
CDM .....	1000V

**RECOMMENDED OPERATING CONDITIONS**

Operating Temperature Range .....	-40°C to +125°C
-----------------------------------	-----------------

**OVERSTRESS CAUTION**

Stresses beyond those listed in Absolute Maximum Ratings may cause permanent damage to the device. Exposure to absolute maximum rating conditions for extended periods

may affect reliability. Functional operation of the device at any conditions beyond those indicated in the Recommended Operating Conditions section is not implied.

**ESD SENSITIVITY CAUTION**

This integrated circuit can be damaged if ESD protections are not considered carefully. SGMICRO recommends that all integrated circuits be handled with appropriate precautions. Failure to observe proper handling and installation procedures can cause damage. ESD damage can range from subtle performance degradation to complete device failure. Precision integrated circuits may be more susceptible to damage because even small parametric changes could cause the device not to meet the published specifications.

**DISCLAIMER**

SG Micro Corp reserves the right to make any change in circuit design, or specifications without prior notice.

**PIN CONFIGURATIONS**

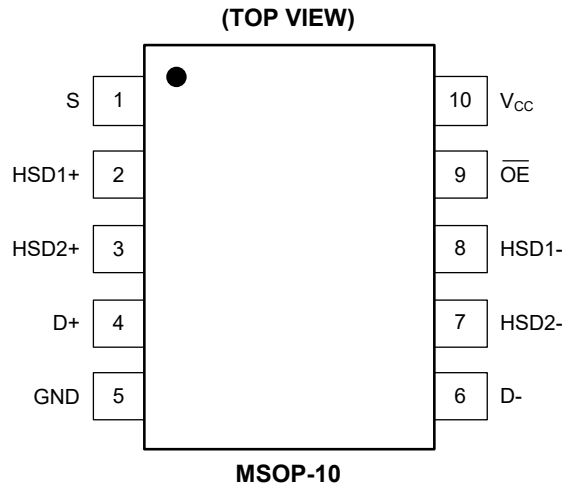
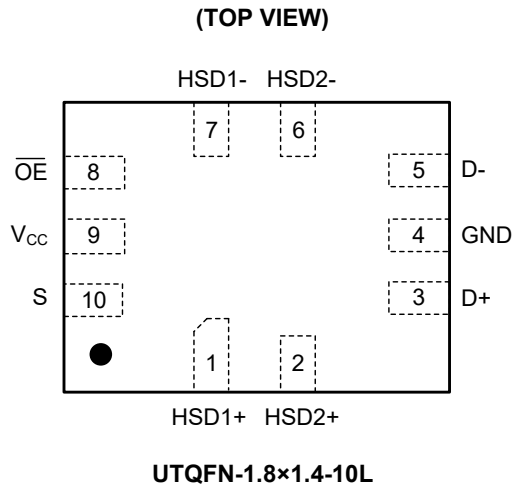

**PIN DESCRIPTION**

PIN		NAME	FUNCTION
UTQFN-1.8x1.4-10L	MSOP-10		
1, 2	2, 3	HSD1+, HSD2+	Data Ports.
3, 5	4, 6	D+, D-	
7, 6	8, 7	HSD1-, HSD2-	
4	5	GND	Ground.
8	9	$\overline{OE}$	Output Enable Control Pin.
9	10	V <sub>CC</sub>	Positive Power Supply Pin.
10	1	S	Select Input Pin.

PACKAGE OUTLINE DIMENSIONS

UTQFN-1.8x1.4-10L

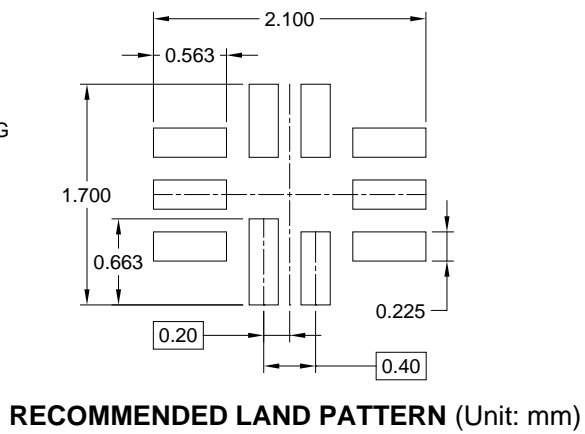
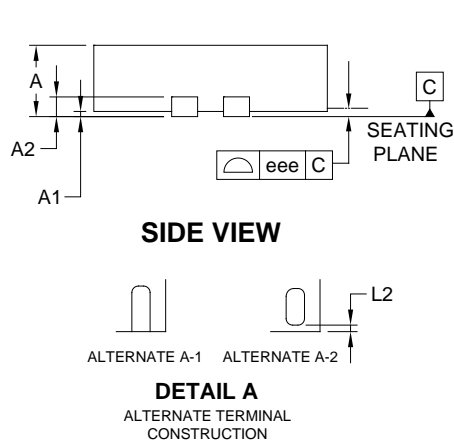
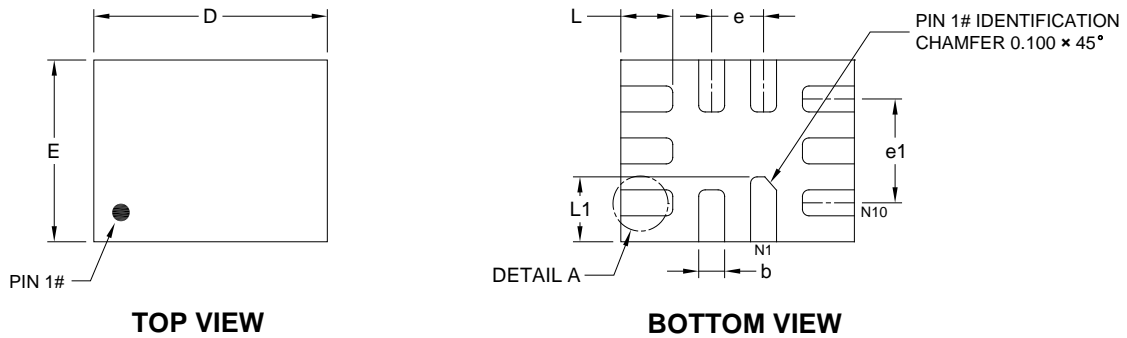

Symbol	Dimensions In Millimeters		
	MIN	MOD	MAX
A	0.450	-	0.600
A1	0.000	-	0.050
A2	0.152 REF		
b	0.150	0.200	0.250
D	1.750	1.800	1.850
E	1.350	1.400	1.450
e	0.400 TYP		
e1	0.800 REF		
L	0.350	0.400	0.450
L1	0.450	0.500	0.550
L2	0.000	-	0.100
eee	-	0.080	-

NOTE: This drawing is subject to change without notice.

PACKAGE OUTLINE DIMENSIONS

MSOP-10

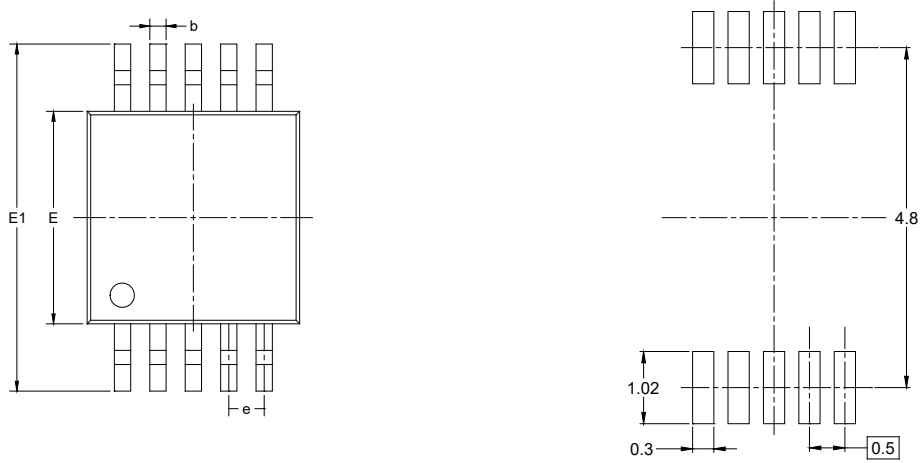

RECOMMENDED LAND PATTERN (Unit: mm)

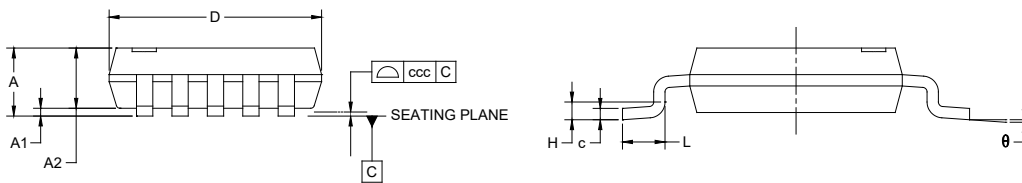

Symbol	Dimensions In Millimeters		
	MIN	MOD	MAX
A	-	-	1.100
A1	0.000	-	0.150
A2	0.750	-	0.950
b	0.170	-	0.330
c	0.080	-	0.230
D	2.900	-	3.100
E	2.900	-	3.100
E1	4.750	-	5.050
e	0.500 BSC		
H	0.250 TYP		
L	0.400	-	0.800
$\theta$	0°	-	8°
ccc	0.100		

NOTES:

1. This drawing is subject to change without notice.
2. The dimensions do not include mold flashes, protrusions or gate burrs.
3. Reference JEDEC MO-187.

## TAPE AND REEL INFORMATION

### REEL DIMENSIONS

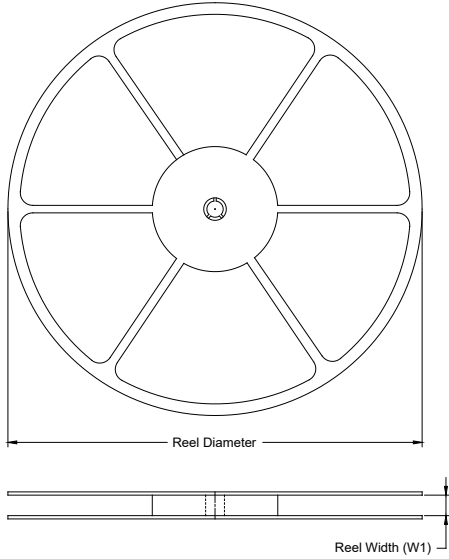

### TAPE DIMENSIONS

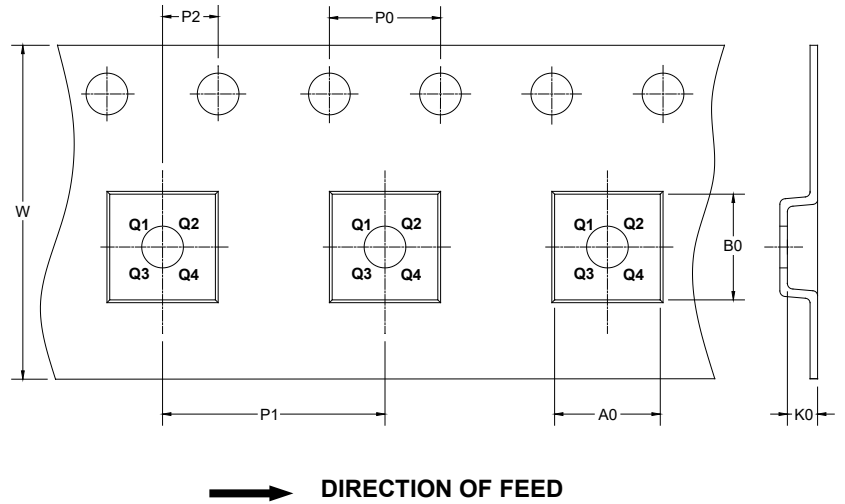

NOTE: The picture is only for reference. Please make the object as the standard.

### KEY PARAMETER LIST OF TAPE AND REEL

Package Type	Reel Diameter	Reel Width W1 (mm)	A0 (mm)	B0 (mm)	K0 (mm)	P0 (mm)	P1 (mm)	P2 (mm)	W (mm)	Pin1 Quadrant
UTQFN-1.8×1.4-10L	7"	9.0	1.75	2.10	0.7	4.0	4.0	2.0	8.0	Q1
MSOP-10	13"	12.4	5.20	3.30	1.50	4.0	8.0	2.0	12.0	Q1

D00001

# PACKAGE INFORMATION

## CARTON BOX DIMENSIONS



NOTE: The picture is only for reference. Please make the object as the standard.

## KEY PARAMETER LIST OF CARTON BOX

Reel Type	Length (mm)	Width (mm)	Height (mm)	Pizza/Carton
7" (Option)	368	227	224	8
7"	442	410	224	18
13"	386	280	370	5

DD0002