

GENERAL DESCRIPTION

The SGM2531C is a single-channel load switch with controlled slew rate. The V_{OUT} rise time can be programmed by setting an additional capacitor to the SS pin, which can minimize inrush current. The device contains an N-MOSFET that can operate over an input voltage range of 4.5V to 22V. With precision 5% current limit, the device can provide excellent accuracy and be well applied to many system protection applications.

Programmable under-voltage lockout or over-voltage protection is used to turn off the device if the V_{IN} drops below or raises over a threshold value, 3% threshold accuracy ensures tight that the downstream circuitry is not damaged by unintended power supply. Fault conditions are indicated by the nFLT pin.

The SGM2531C is available in Green SOIC-8 (Exposed Pad) and TDFN-2x3-8BL packages.

FEATURES

- **Wide Input Voltage Range from 4.5V to 22V with Surge up to 30V**
- **Low On-Resistance:**
 - ◆ **SOIC-8 (Exposed Pad): 60mΩ**
 - ◆ **TDFN-2x3-8BL: 50mΩ**
- **Programmable Output Ramp Time**
- **Programmable Current Limit: 100mA to 3A**
- **5% Current Limit Accuracy at 1A**
- **Enable Interface Pin**
- **Full Set of Protections**
 - ◆ **Short-Circuit Protection**
 - ◆ **Over-Voltage Protection**
 - ◆ **Under-Voltage Lockout**
 - ◆ **Fault Condition Indication Pin (nFLT)**
- **Thermal Shutdown: Auto-Retry**
- **-40°C to +125°C Junction Temperature Range**
- **Available in Green SOIC-8 (Exposed Pad) and TDFN-2x3-8BL Packages**

TYPICAL APPLICATION

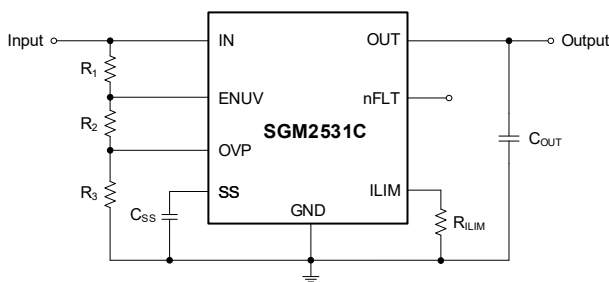

Figure 1. Typical Application Circuit

APPLICATIONS

- Set-Top Boxes, Gaming Consoles
- HDD and SSD Drives
- Smart E-Meters
- eFuse/USB Switches
- Adapter Power Cables

PACKAGE/ORDERING INFORMATION

MODEL	PACKAGE DESCRIPTION	SPECIFIED TEMPERATURE RANGE	ORDERING NUMBER	PACKAGE MARKING	PACKING OPTION
SGM2531C	SOIC-8 (Exposed Pad)	-40°C to +125°C	SGM2531CXPS8G/TR	SGM 2531CXPS8 XXXXX	Tape and Reel, 4000
	TDFN-2×3-8BL	-40°C to +125°C	SGM2531CXTDC8G/TR	0TQ XXXX	Tape and Reel, 3000

MARKING INFORMATION

NOTE: XXXXX = Date Code, Trace Code and Vendor Code. XXXX = Date Code, Trace Code and Vendor Code.

SOIC-8 (Exposed Pad)

XXXXX

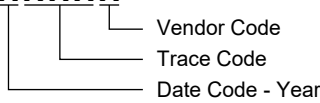

TDFN-2×3-8BL

XXXX

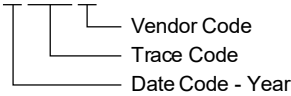

Green (RoHS & HSF): SG Micro Corp defines "Green" to mean Pb-Free (RoHS compatible) and free of halogen substances. If you have additional comments or questions, please contact your SGMICRO representative directly.

ABSOLUTE MAXIMUM RATINGS

IN, OUT, ENUV, nFLT, OVP to GND.....	-0.3V to 24V
IN, OUT to GND (Transient < 100µs)	-0.3V to 30V
SS, ILIM to GND	-0.3V to 6V
Junction Temperature	+150°C
Storage Temperature Range.....	-65°C to +150°C
Lead Temperature (Soldering, 10s)	+260°C
Package Thermal Resistance	
SOIC-8 (Exposed Pad), θ _{JA}	41.9°C/W
SOIC-8 (Exposed Pad), θ _{JB}	17.9°C/W
SOIC-8 (Exposed Pad), θ _{JC (TOP)}	42.9°C/W
SOIC-8 (Exposed Pad), θ _{JC (BOT)}	9.9°C/W
TDFN-2×3-8BL, θ _{JA}	48.3°C/W
TDFN-2×3-8BL, θ _{JB}	22.5°C/W
TDFN-2×3-8BL, θ _{JC (TOP)}	62.4°C/W
TDFN-2×3-8BL, θ _{JC (BOT)}	7.3°C/W
ESD Susceptibility	
HBM.....	4000V
CDM	1000V

RECOMMENDED OPERATING CONDITIONS

Supply Voltage.....	4.5V to 22V
Operating Junction Temperature Range.....	-40°C to +125°C

OVERSTRESS CAUTION

Stresses beyond those listed in Absolute Maximum Ratings may cause permanent damage to the device. Exposure to absolute maximum rating conditions for extended periods may affect reliability. Functional operation of the device at any conditions beyond those indicated in the Recommended Operating Conditions section is not implied.

ESD SENSITIVITY CAUTION

This integrated circuit can be damaged if ESD protections are not considered carefully. SGMICRO recommends that all integrated circuits be handled with appropriate precautions. Failure to observe proper handling and installation procedures can cause damage. ESD damage can range from subtle performance degradation to complete device failure. Precision integrated circuits may be more susceptible to damage because even small parametric changes could cause the device not to meet the published specifications.

DISCLAIMER

SG Micro Corp reserves the right to make any change in circuit design, or specifications without prior notice.

PIN CONFIGURATIONS

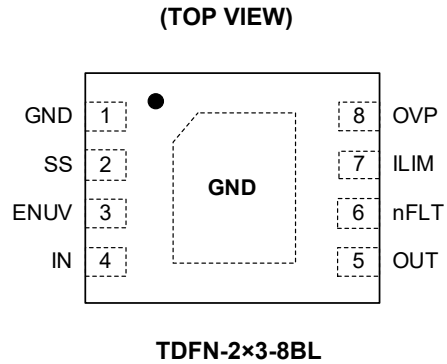
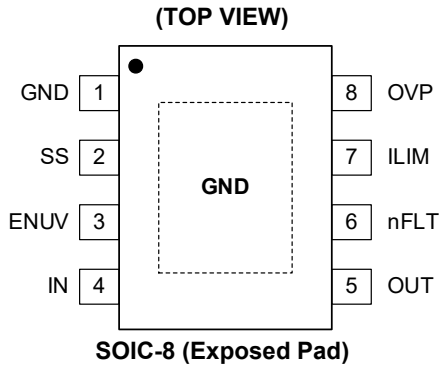

PIN	NAME	FUNCTION
1	GND	Ground.
2	SS	Soft-Start Pin. The capacitor between SS and GND pins will set the slew rate according to the application requirements.
3	ENUV	Enable and Under-Voltage Lockout Input. Asserting ENUV pin high enables the device. As a UVLO pin, the UVLO threshold is programmed by an external resistor divider.
4	IN	Input Supply Voltage. Connect to a 4.5V to 22V power source.
5	OUT	Output of the Device.
6	nFLT	Alert Open-Drain Output Pin. Fault conditions (over-voltage, overload, fast-trip or thermal shutdown condition) are indicated by the nFLT pin.
7	ILIM	Programming Current Limit Pin. A resistor between this pin and GND sets the overload and short-circuit current limit levels. Do not leave this pin floating.
8	OVP	Over-Voltage Protection Pin. The over-voltage threshold is programmed by the resistor divider from the power supply to the OVP terminal to GND. If a voltage on the OVP pin is higher than V_{OVPR} , the internal MOSFET will be turned off and protect the downstream load.
Exposed Pad	GND	Ground.

ELECTRICAL CHARACTERISTICS

(T_J = -40°C to +125°C, V_{IN} = 4.5V to 22V, V_{ENUV} = 2V, V_{OVP} = 0V, R_{ILIM} = 95.3kΩ, C_{SS} = Open, nFLT = Open, typical values are at T_J = +25°C, unless otherwise noted.)

PARAMETER	SYMBOL	CONDITIONS	MIN	TYP	MAX	UNITS	
Input Supply (IN)							
Input Voltage Range	V _{IN}		4.5		22	V	
UVLO Threshold Voltage	V _{UVR}	Rising	2.3	2.36	2.45	V	
UVLO Hysteresis	V _{UVHYS}		70	95	120	mV	
Supply Quiescent Current	I _{Q_ON}	V _{ENUV} = 2V, V _{IN} = 12V	100	170	250	μA	
Supply Disabled Current	I _{Q_OFF}	V _{ENUV} = 0V, V _{IN} = 12V		1	2.5	μA	
Over-Voltage Protection (OVP)							
Over-Voltage Threshold Voltage	V _{OVP}	Rising	1.35	1.39	1.43	V	
	V _{OVPF}	Falling	1.3	1.34	1.38	V	
OVP Input Leakage Current	I _{OVP}	0V ≤ V _{OVP} ≤ 22V	-100		100	nA	
Enable and Under-Voltage Lockout (ENUV)							
ENUV Threshold Voltage	V _{ENR}	Rising	1.35	1.39	1.43	V	
	V _{ENF}	Falling	1.3	1.34	1.38	V	
ENUV Threshold Voltage to Reset Thermal Fault, Falling	V _{ENF_RST}		0.46			V	
ENUV Input Leakage Current	I _{ENUV}	0 ≤ V _{ENUV} ≤ 22V	-100		100	nA	
Soft-Start: Output Ramp Control (SS)							
SS Charging Current	I _{SS}	V _{SS} = 0V	0.82	1	1.25	μA	
SS Discharging Resistance	R _{SS}	V _{ENUV} = 0V, I _{SS} = 10mA sinking	280	350	420	Ω	
		V _{ENUV} = 1V, I _{SS} = 10mA sinking		145			
SS Maximum Capacitor Voltage	V _{SSMAX}			5.3		V	
SS to OUT Gain	GAIN _{SS}	ΔV _{OUT} /ΔV _{SS}	4.95	5.06	5.20	V/V	
Current Limit Programming (ILIM)							
ILIM Pin Bias Current	I _{ILIM}		4.3	5.02	5.7	μA	
Current Limit	I _{LIMIT}	SOIC-8 (Exposed Pad)	R _{ILIM} = 35.7kΩ, T _J = -40°C to +85°C	0.330	0.384	0.440	A
			R _{ILIM} = 45.3kΩ, T _J = -40°C to +85°C	0.425	0.484	0.545	
			R _{ILIM} = 95.3kΩ, T _A = T _J = +25°C	0.95	1	1.05	
			R _{ILIM} = 95.3kΩ, T _J = -40°C to +85°C	0.92	1	1.08	
			R _{ILIM} = 150kΩ, T _J = -40°C to +85°C	1.41	1.56	1.70	
		TDFN-2×3-8BL	R _{ILIM} = 35.7kΩ, T _J = -40°C to +85°C	0.330	0.390	0.455	
			R _{ILIM} = 45.3kΩ, T _J = -40°C to +85°C	0.42	0.49	0.56	
			R _{ILIM} = 95.3kΩ, T _A = T _J = +25°C	0.95	1	1.05	
			R _{ILIM} = 95.3kΩ, T _J = -40°C to +85°C	0.92	1	1.08	
			R _{ILIM} = 150kΩ, T _J = -40°C to +85°C	1.420	1.575	1.720	
Fast-Trip Comparator Threshold	I _{FAST-TRIP}	R _{ILIM} in kΩ	1.65 × I _{LIMIT}			A	
On-Resistance (IN - OUT)							
FET On-Resistance	R _{DSON}	SOIC-8 (Exposed Pad)	25	60	110	mΩ	
		TDFN-2×3-8BL	20	50	85		
Pass FET Output (OUT)							
OUT Bias Current in Off-State	I _{LKG_OUT}	V _{ENUV} = 0V, V _{OUT} = 0V (sourcing)	-2	0	2	μA	
	I _{SINK_OUT}	V _{ENUV} = 0V, V _{OUT} = 300mV (sinking)	-1	0	1		
Fault Flag (nFLT): Active-Low							
nFLT Pull-Down Resistance	R _{nFLT}	Device in fault condition, V _{OVP} = high, I _{nFLT} = 100mA	5	17	35	Ω	
nFLT Input Leakage Current	I _{nFLT}	Device not in fault condition, V _{nFLT} = 0V, 22V	-0.5	0	0.5	μA	
Thermal Shutdown (TSD)							
Thermal Shutdown Threshold	T _{SD}	Rising		150		°C	
Thermal Shutdown Hysteresis	T _{HYS}			20		°C	

TIMING REQUIREMENTS

($T_J = -40^{\circ}\text{C}$ to $+125^{\circ}\text{C}$, $V_{IN} = 4.5\text{V}$ to 22V , $V_{ENUV} = 2\text{V}$, $V_{OVP} = 0\text{V}$, $R_{LIM} = 95.3\text{k}\Omega$, $C_{SS} = \text{Open}$, $nFLT = \text{Open}$, typical values are at $T_J = +25^{\circ}\text{C}$, unless otherwise noted.)

PARAMETER	SYMBOL	CONDITIONS	MIN	TYP	MAX	UNITS
Enable and Under-Voltage Lockout (ENUV)						
Turn-On Delay	t_{ON_DLY}	ENUV \uparrow to $V_{OUT} = 1\text{V}$, $C_{SS} = \text{Open}$		90		μs
Turn-Off Delay	t_{OFF_DLY}	ENUV \downarrow to $V_{OUT}\downarrow$		2		μs
Over-Voltage Protection (OVP)						
OVP Disable Delay	t_{OVP_DLY}	OVP \uparrow to nFLT \downarrow		3		μs
Soft-Start: Output Ramp Control (SS)						
Output Ramp Time	t_{SS}	ENUV \uparrow to $V_{OUT} = 11\text{V}$, with $C_{SS} = \text{Open}$, $C_{OUT} = 2.2\mu\text{F}$	0.12	0.24	0.38	ms
		ENUV \uparrow to $V_{OUT} = 11\text{V}$, with $C_{SS} = 1.2\text{nF}$, $C_{OUT} = 2.2\mu\text{F}$	2.3	2.8	3.4	
Current Limit Programming (I_{LIM})						
Fast-Trip Comparator Delay	$t_{FAST_TRIP_DLY}$	$I_{OUT} > I_{FAST_TRIP}$		3		μs
Thermal Shutdown (TSD)						
Retry Delay after Thermal Shutdown Recovery, $T_J < [T_{SD} - 20^{\circ}\text{C}]$	t_{SD_DLY}	$V_{IN} = 12\text{V}$		800		ms
		$V_{IN} = 4.5\text{V}$		800		ms

PARAMETRIC MEASUREMENT INFORMATION

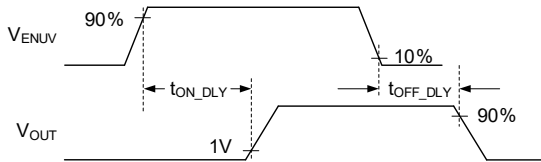

Figure 2. t_{ON_DLY} and t_{OFF_DLY} Waveforms

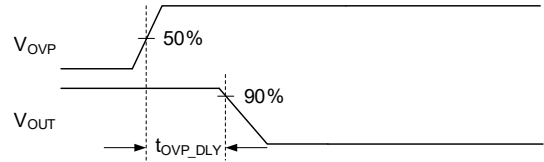

Figure 3. t_{OVP_DLY} Waveforms

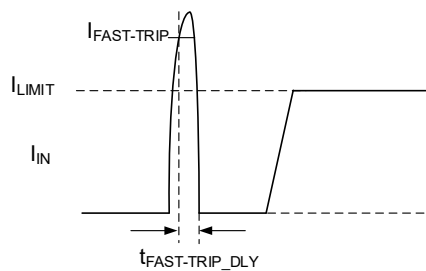
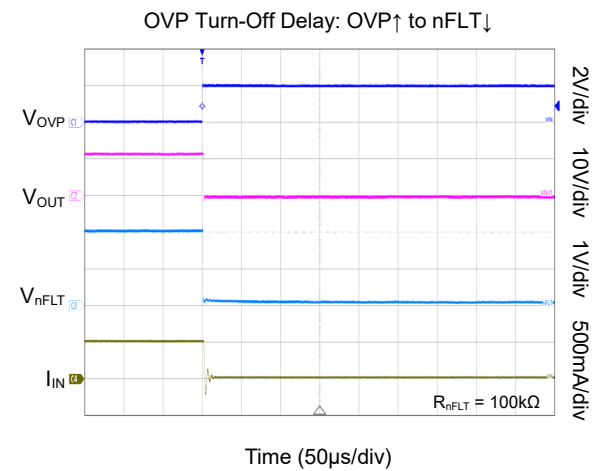
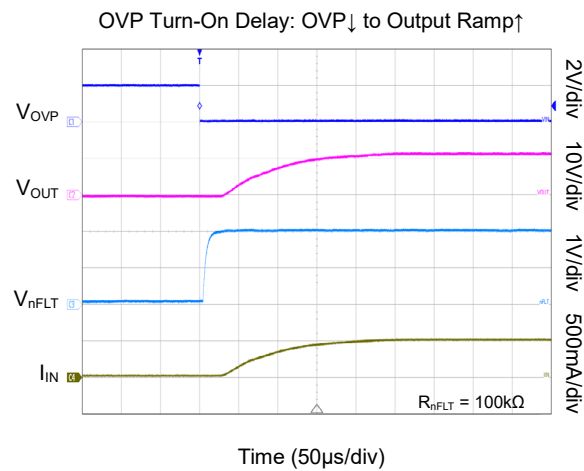
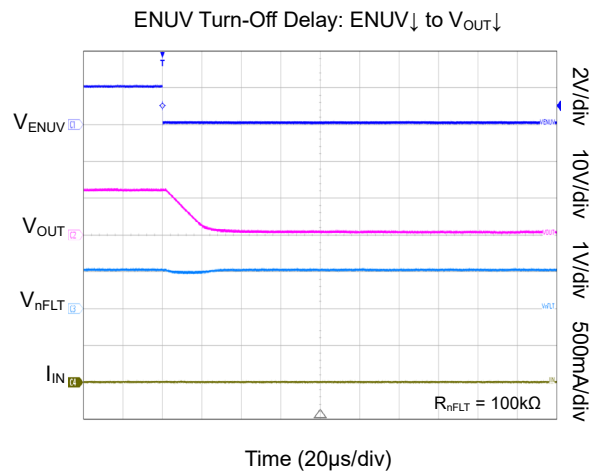
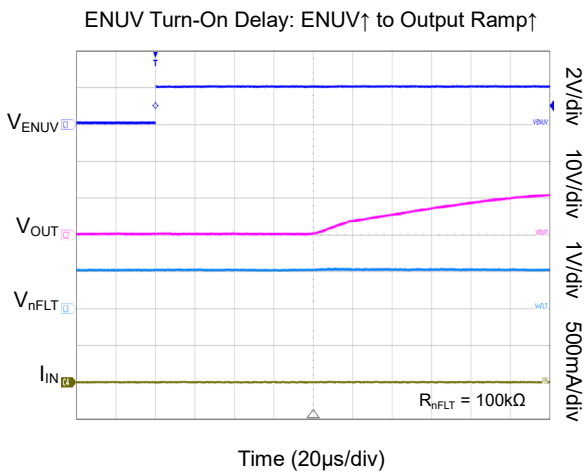
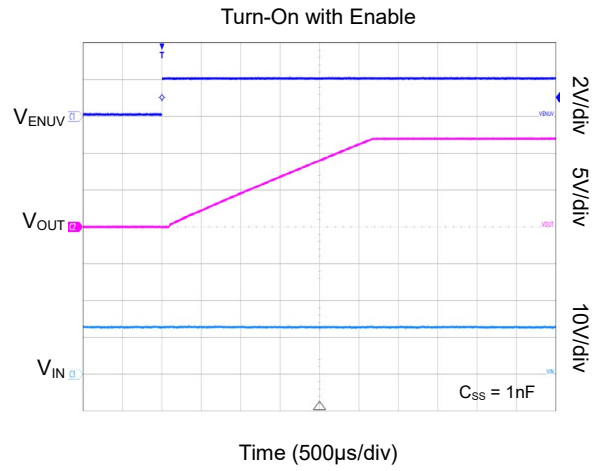
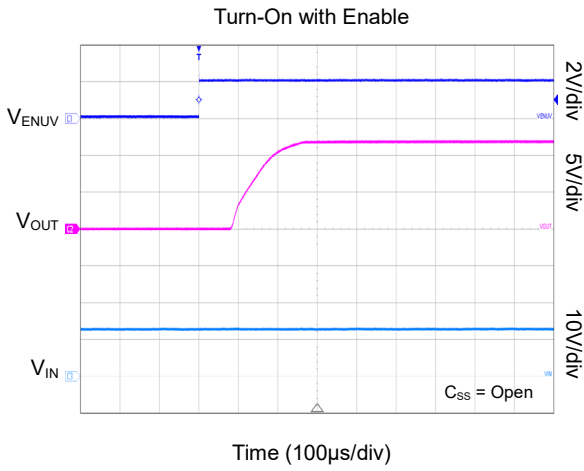

Figure 4. $t_{FAST_TRIP_DLY}$ Waveforms

TYPICAL PERFORMANCE CHARACTERISTICS

$V_{IN} = 12V$, $C_{IN} = 10\mu F$, $C_{SS} = \text{Open}$, typical values are at $T_J = +25^\circ C$, unless otherwise noted.



TYPICAL PERFORMANCE CHARACTERISTICS (continued)

$V_{IN} = 12V$, $C_{IN} = 10\mu F$, $C_{SS} = \text{Open}$, typical values are at $T_J = +25^\circ C$, unless otherwise noted.

Hot-Short: Fast-Trip Response and Current Regulation

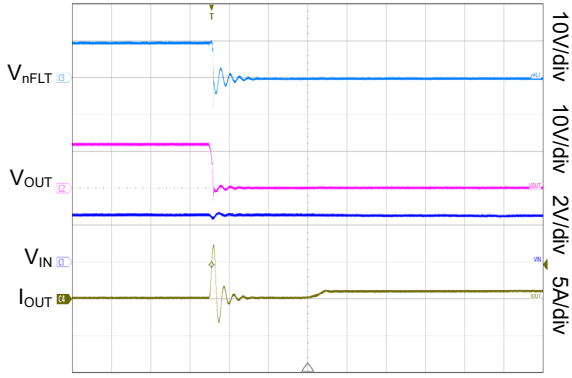

Time (20µs/div)

Hot-Short: Fast-Trip Response (Zoomed)

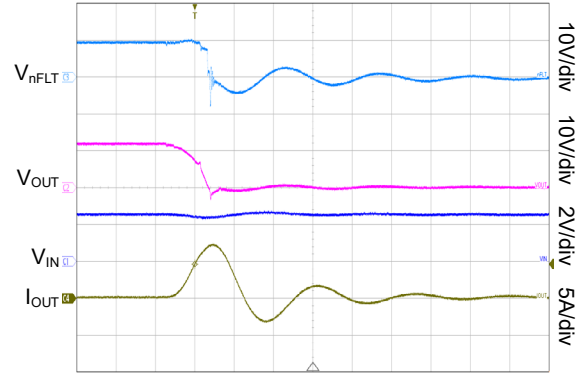

Time (2µs/div)

Current Regulation (CR Load)

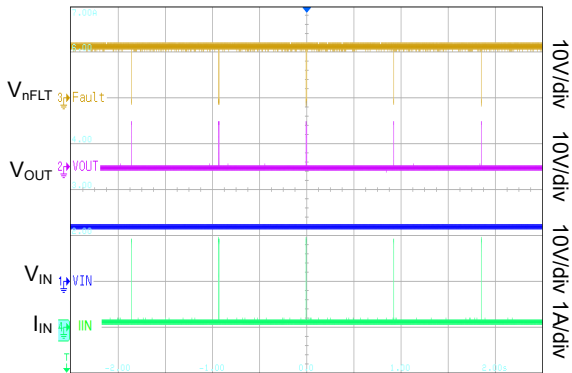

Time (500ms/div)

Current Regulation (CR Load) (Zoomed)

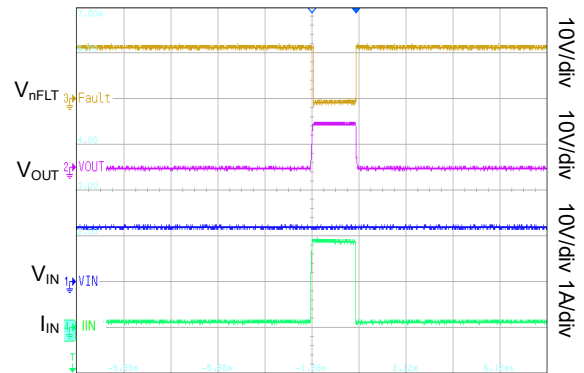

Time (2ms/div)

Supply Current vs. Input Voltage

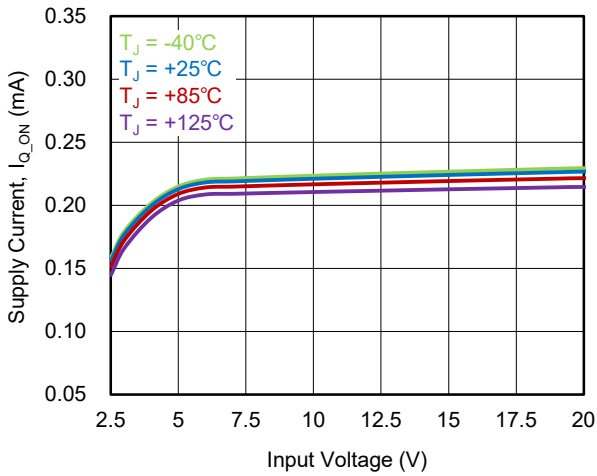

Supply Current vs. Input Voltage

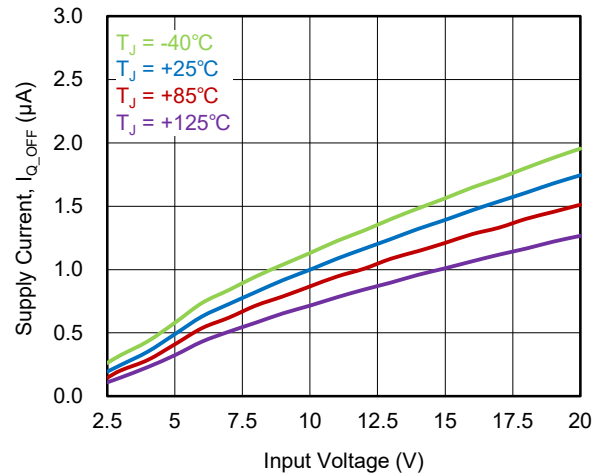

TYPICAL PERFORMANCE CHARACTERISTICS (continued)

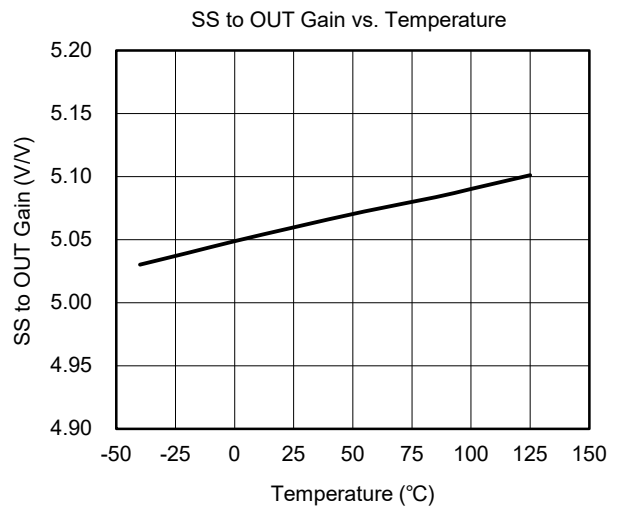
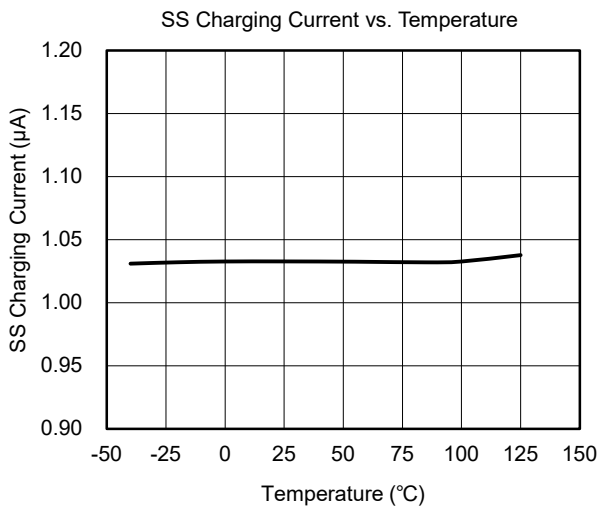
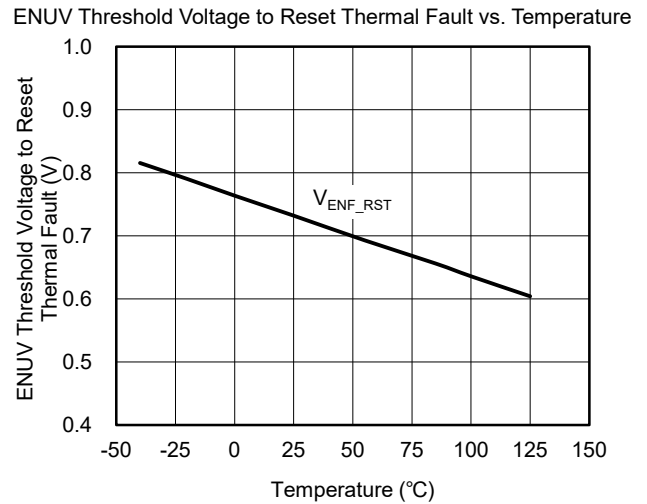
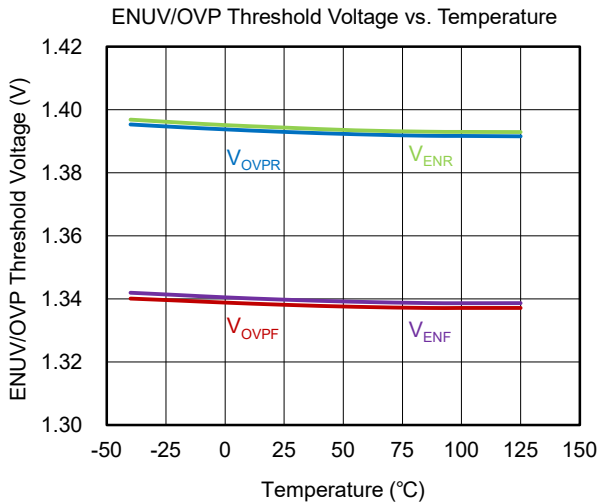
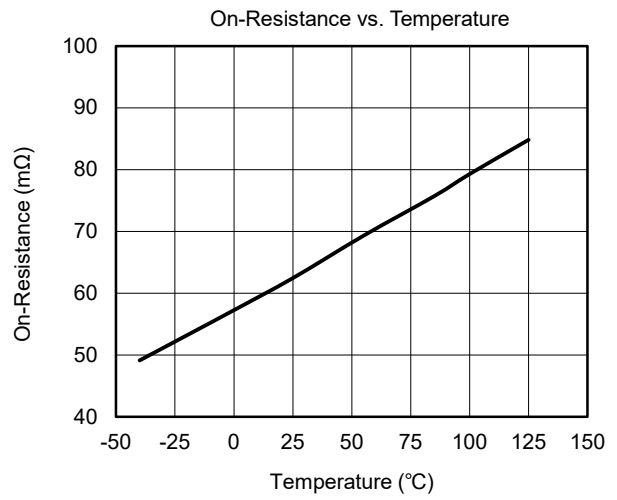
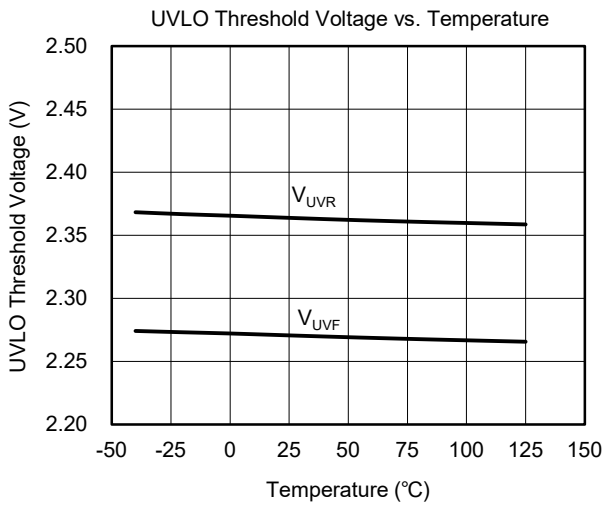

TYPICAL PERFORMANCE CHARACTERISTICS (continued)

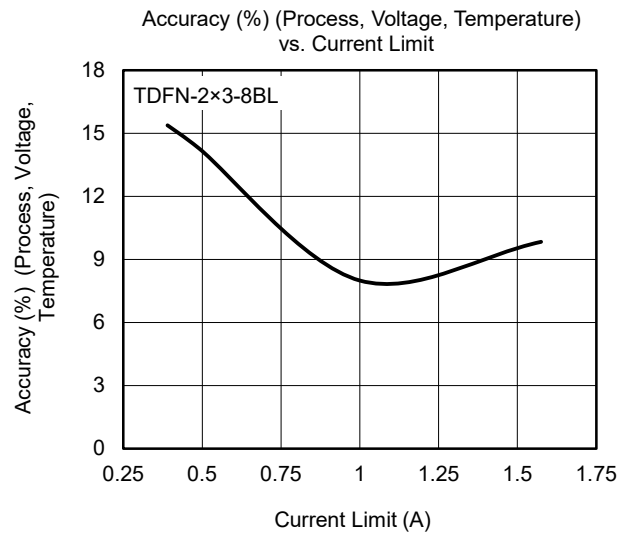
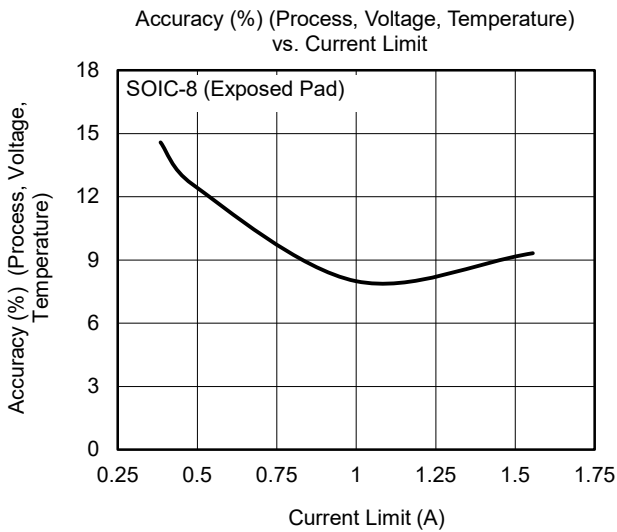
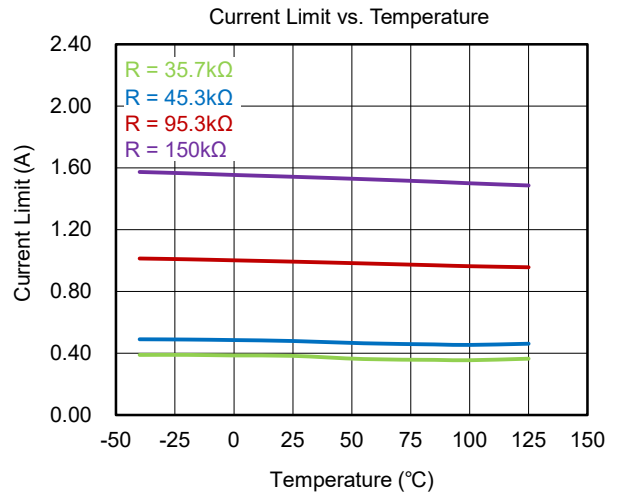
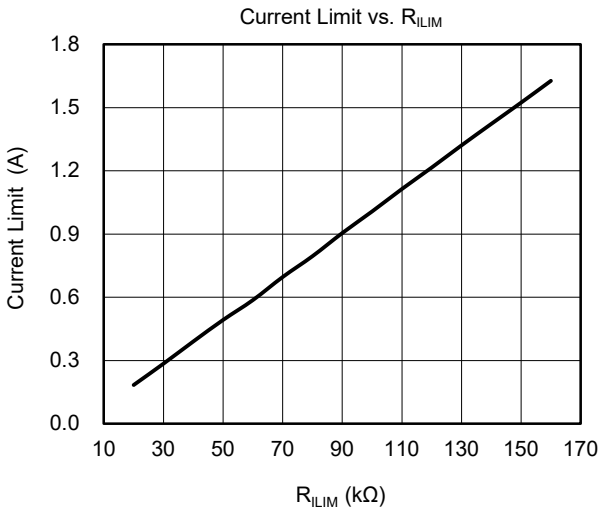
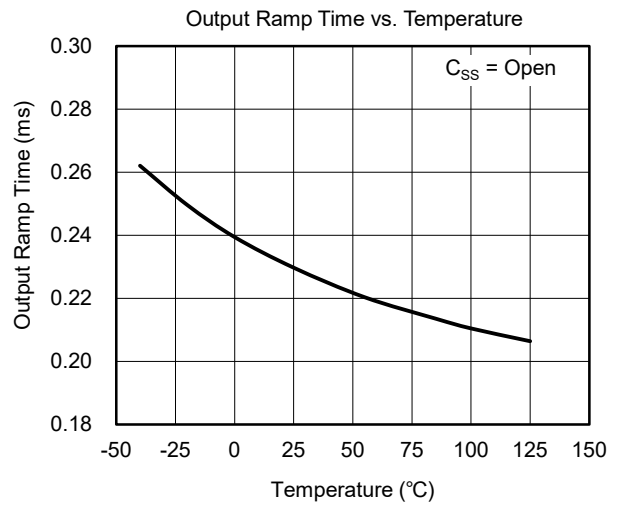
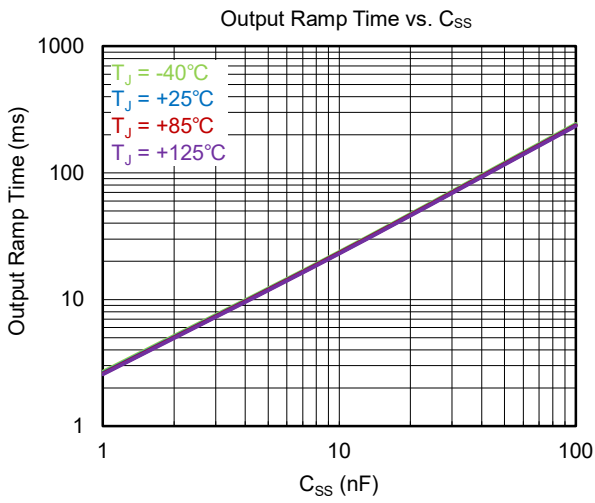

FUNCTIONAL BLOCK DIAGRAM

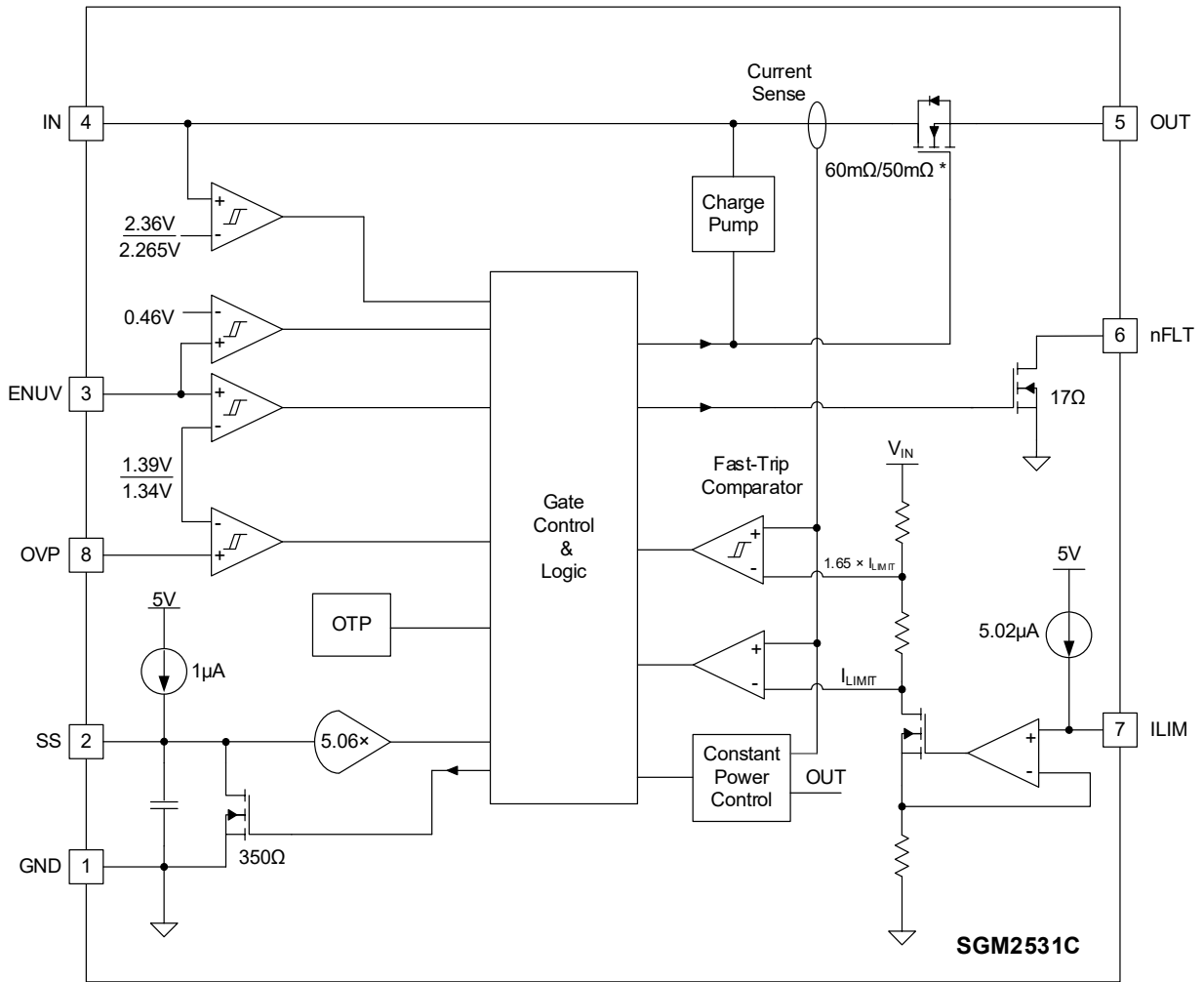

NOTE *: 60mΩ for SOIC-8 (Exposed Pad) Package.
50mΩ for TDFN-2x3-8BL Package.

Figure 5. Block Diagram

DETAILED DESCRIPTION

The SGM2531C is an 8-pin, 4.5V to 22V eFuse with thermal shutdown. To reduce voltage drop for low voltage and high current rails, the device implements a low on-resistance N-MOSFET which reduces the dropout voltage across the device.

The configurable rise time of the device greatly reduces inrush current caused by large bulk load capacitances or hot-plug boards, thereby reducing or eliminating power supply drop. The current limit threshold can be programmed between 0.1A and 3A through an external resistor.

When the output load exceeds the current limit threshold or a short-circuit event is present, the device limits the output current to a safe level by increasing the on-resistance of the power switch. Continuous heavy overloads and short-circuits that increase power dissipation of the switch can cause the junction temperature to rise, in which case thermal protection circuit will shut off the switch to prevent damage.

The device starts its operation by monitoring the V_{IN} bus. When V_{IN} exceeds the under-voltage lockout threshold, the device samples the ENUV pin. A high level on this pin enables the internal N-MOSFET. When V_{IN} exceeds UVLO threshold and V_{ENUV} exceeds 1.39V, the internal N-MOSFET of the device starts conducting and allows current to flow from IN to OUT. When V_{ENUV} is held low (below V_{ENF}), internal N-MOSFET is turned off. When the voltage of OVP pin is more than V_{OVPR} , the internal N-MOSFET is turned off and protects the downstream load. The device also features a fault flag output (nFLT) pin to monitor system status and control downstream load. The device has a thermal protection feature to protect itself against thermal damage due to over-temperature.

Adjustable Enable and Under-Voltage Lockout (UVLO)

The ENUV pin controls the state of the switch. In its high state, the internal N-MOSFET is enabled. A low level on this pin turns off the internal N-MOSFET. High and low levels are specified in the electrical characteristics of the datasheet.

It is recommended to add an external bypass capacitor between ENUV and GND pins to avoid the noise of instability power or probabilistic power failure. The ENUV falling edge deglitch delay is 1µs (TYP).

As an under-voltage lockout pin, the UVLO threshold is programmed by an external resistor divider, as shown in Figure 6.

Once the input rail is under-voltage, the N-MOSFET will be turned off quickly. If this function is not needed, connect the ENUV pin to the V_{IN} rail to avoid it. Do not leave the ENUV pin floating.

The device implements the input UVLO and sets two UVLOs in combination with ENUV. If $V_{IN} < V_{UVF}$, the device is disabled and ENUV can set the V_{IN} rise threshold, so the device can set the section active voltage to avoid the input rail fluctuation.

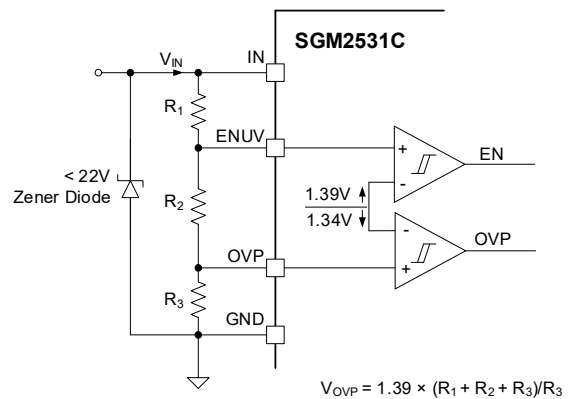

Figure 6. ENUV and Input OVP Set by R_1 , R_2 and R_3

Input Rail Over-Voltage Protection (OVP)

The SGM2531C features over-voltage protection function. The over-voltage threshold is programmed by the resistor divider from the power supply to the OVP terminal and to GND, as shown in Figure 6. If the voltage of OVP pin is higher than V_{OVPR} , the device turns off the internal N-MOSFET. If not used, connect this pin to GND.

DETAILED DESCRIPTION (continued)

Hot-Plug and Inrush Current Restrict

In the use of hot-plug boards, the surge current limits the voltage drop of the backplane power supply voltage and will lead to the unintended resets of the system power supply. The capacitor between SS and GND pins will set the slew rate according to the application requirements. An approximate formula for the relationship between C_{SS} and slew rate is shown in Equation 1:

$$I_{SS} = \frac{C_{SS}}{GAIN_{SS}} \times \frac{dV_{OUT}}{dt} \tag{1}$$

where:

$I_{SS} = 1\mu A$ (TYP)

$dV_{OUT}/dt =$ Target output slew rate

$GAIN_{SS} = \Delta V_{OUT}/\Delta V_{SS} = 5.06$

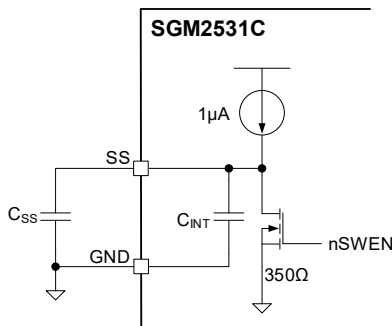

Figure 7. Output Ramp Time (t_{SS}) is Set by C_{SS}

Equation 2 shows how to calculate the total output ramp time (t_{SS}) when the output rises from 0V to V_{IN} :

$$t_{SS} = 19.5 \times 10^4 \times V_{IN} \times C_{SS} \tag{2}$$

where C_{SS} is in F.

The inrush current (I_{INRUSH}) can be calculated as:

$$I_{INRUSH} = C_{OUT} \times \frac{V_{IN}}{t_{SS}} \tag{3}$$

Rise time can be calculated by multiplying the input voltage by the slew rate. If floating this pin, the slew rate of the output obtains a default value $\sim 50V/ms$ (minimum t_{SS}).

Over-Current and Short-Circuit Protections

The device limits current to the output in case of output shorts and overloads. If an event occurs, device goes into current limit action, and the value of the current limit (I_{LIMIT}) is set by R_{ILIM} resistor:

$$I_{LIMIT} = 10.3 \times 10^{-3} \times R_{ILIM} + 0.017 \tag{4}$$

$$R_{ILIM} = \frac{I_{LIMIT} - 0.017}{10.3 \times 10^{-3}} \tag{5}$$

where:

I_{LIMIT} is the value of overload current limit in A.

R_{ILIM} is the current limit programming resistor in $k\Omega$.

In addition to the general over-current protection, the SGM2531C also integrates fast-trip over-current protection with quicker response time.

Overload Protection

When the output load exceeds the current limit threshold, the internal current limit amplifier limits the output current to the predetermined value by increasing the on-resistance of the power switch. When the over-current limit condition lasts more than 2ms, the SGM2531C enters the hiccup mode with 2ms on-time and 800ms off-time. When heavy overloads increase the power dissipation in the switch, causing the junction temperature reach the thermal shutdown threshold within 2ms, the internal N-MOSFET is turned off. The fault pin (nFLT) is asserted and will be pulled low to indicate a fault until the thermal shutdown condition is released.

DETAILED DESCRIPTION (continued)

Short-Circuit Protection

A transient short-circuit occurs, due to the limited bandwidth of the current limit amplifier, which cannot respond quickly to this event. The SGM2531C contains a fast-trip comparator with a threshold ($I_{FAST-TRIP}$). If $I_{OUT} > I_{FAST-TRIP}$, the comparator turns off the N-MOSFET and terminates the short-circuit peak current across the N-MOSFET rapidly. The fast-trip threshold is 1.65 times the overload current limit. The fast-trip comparator can terminate the transient short-circuit peak current, and then the current limit function limits the output current to I_{LIMIT} .

$$I_{FAST-TRIP} = 1.65 \times I_{LIMIT} \tag{6}$$

The $I_{FAST-TRIP}$ is fast-trip current limit. To prevent the input voltage spike from damaging the device, a Zener diode should be added. If the switching voltage of SGM2531C is more than 15V, the diode no more than 22V (> 0.5W) is needed, as shown in Figure 6.

Startup with Output Shorted

For systems with short-circuit during startup, the current is limited to I_{LIMIT} . When the power dissipation of the MOSFET is greater than 15W, it will be limited to 15W, and the I_{LIMIT} will be decreased. After this, power dissipation will lead to device thermal protection.

IN, OUT and GND Pins

To limit the voltage drop on the input supply caused by transient inrush current when the switch turns on into a discharged load capacitor, a capacitor needs to be placed between IN and GND pins. Use a bypass capacitor as close as possible between IN and GND pins. Due to the integrated body diode in the N-MOSFET, a C_{IN} greater than C_{OUT} is highly recommended. When the system power supply is removed, C_{OUT} greater than C_{IN} will cause V_{OUT} to exceed V_{IN} .

This will result in current flow through the body diode from V_{OUT} to V_{IN} . A C_{IN} to C_{OUT} ratio of 10 to 1 is recommended for minimizing V_{IN} dip caused by inrush currents during startup. In the on-state condition, V_{OUT} can be calculated using the Equation 7:

$$V_{OUT} = V_{IN} - (R_{DS(ON)} \times I_{OUT}) \tag{7}$$

where $R_{DS(ON)}$ is the on-resistance of internal N-MOSFET.

Fault Response

The SGM2531C has a fault output signal to indicate the operation state of the device. When any of over-voltage, over-current or thermal shutdown occurs, the nFLT pin is pulled low. The nFLT pin is open-drain output which can be connected to OUT or another external voltage through an external pull-up resistor. If not used, leave it floating or connect it to GND.

Thermal Shutdown (TSD)

Thermal shutdown protects the device from excessive temperature. Once the device is shut down due to TSD fault, it would restart automatically after T_J drops below $[T_{SD} - 20^\circ C]$ and retry delay.

Shutdown Control

The device has a built-in over-temperature shutdown circuitry designed to protect the internal N-MOSFETs if the junction temperature exceeds T_{SD} . The internal N-MOSFET can be remotely turned off by taking the ENUV pin below its 1.34V threshold as shown in Figure 8. Upon releasing the ENUV pin, the device turns on with soft-start cycle.

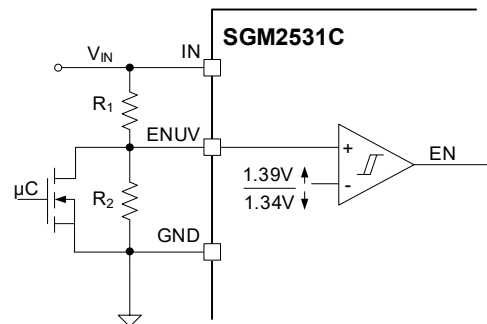

Figure 8. Shutdown Control

DETAILED DESCRIPTION (continued)

Operational Overview

The device function is shown in Table 1.

Table 1. Operational Overview of Device Functions

Device	SGM2531C
Startup	Inrush ramp controlled by SS pin via an external capacitor.
	Limit inrush current to I_{LIMIT} level.
	If $T_J > T_{SD}$, the device is shut down.
Over-Current Response	Current is limited to I_{LIMIT} level.
	Power dissipation increases as $(V_{IN} - V_{OUT})$ increases. When the power dissipation exceeds 15W, it will be limited to 15W.
	$T_J > T_{SD}$ or at most 2ms, the device is turned off. The SGM2531C will attempt restart t_{SD_DLY} after $T_J < [T_{SD} - 20^{\circ}C]$ and retry delay.
Short-Circuit Response	Fast turn-off when $I_{LOAD} > I_{FAST-TRIP}$.
	According to the standard startup cycle, fast refresh and limit the current to I_{LIMIT} .

Smart Load Switch

The SGM2531C can be used as a smart power switch with wide input voltage range from 4.5V to 22V. The devices provide soft-start, current limit, over-temperature protection, a fault indicate, and over- or under-voltage lockout.

Figure 9 shows the typical implementation and usage as a load switch. It is recommended to add a freewheeling diode across the load when load is highly inductive.

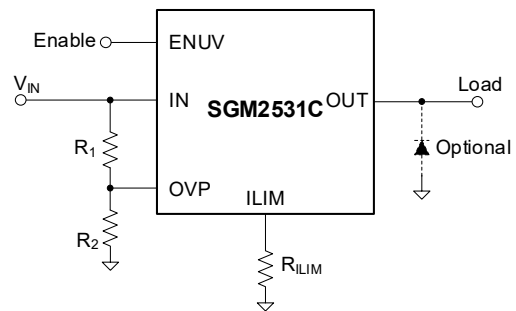

Figure 9. Smart Load Switch Implementation

REVISION HISTORY

NOTE: Page numbers for previous revisions may differ from page numbers in the current version.

Changes from Original (APRIL 2024) to REV.A	Page
Changed from product preview to production data.....	All

PACKAGE OUTLINE DIMENSIONS

SOIC-8 (Exposed Pad)

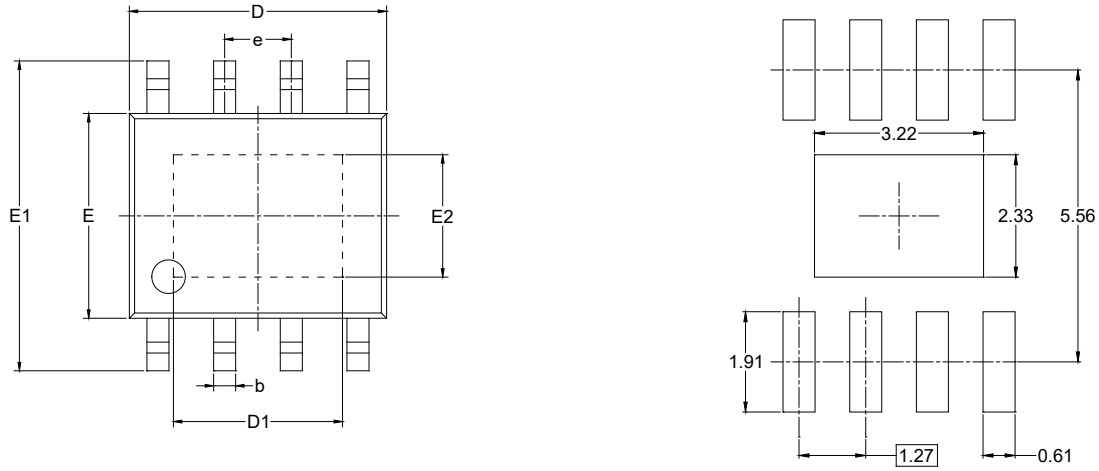

RECOMMENDED LAND PATTERN (Unit: mm)

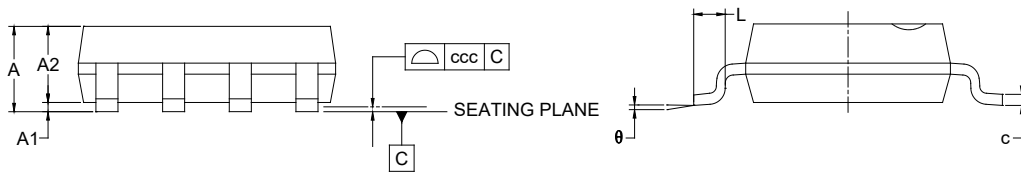

Symbol	Dimensions In Millimeters		
	MIN	MOD	MAX
A			1.700
A1	0.000	-	0.150
A2	1.250	-	1.650
b	0.330	-	0.510
c	0.170	-	0.250
D	4.700	-	5.100
D1	3.020	-	3.420
E	3.800	-	4.000
E1	5.800	-	6.200
E2	2.130	-	2.530
e	1.27 BSC		
L	0.400	-	1.270
θ	0°	-	8°
ccc	0.100		

NOTES:

1. This drawing is subject to change without notice.
2. The dimensions do not include mold flashes, protrusions or gate burrs.
3. Reference JEDEC MS-012.

PACKAGE OUTLINE DIMENSIONS

TDFN-2x3-8BL

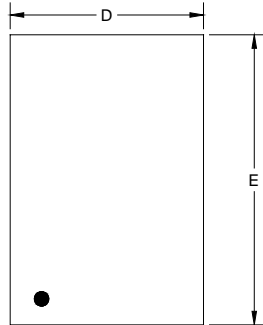

TOP VIEW

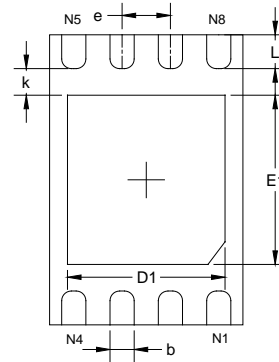

BOTTOM VIEW

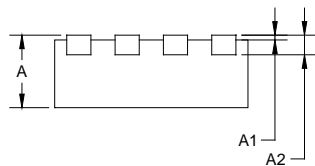

SIDE VIEW

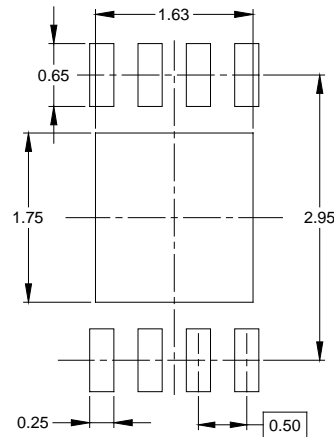

RECOMMENDED LAND PATTERN (Unit: mm)

Symbol	Dimensions In Millimeters		Dimensions In Inches	
	MIN	MAX	MIN	MAX
A	0.700	0.800	0.028	0.031
A1	0.000	0.050	0.000	0.002
A2	0.203 REF		0.008 REF	
D	1.950	2.050	0.077	0.081
D1	1.530	1.730	0.060	0.068
E	2.950	3.050	0.116	0.120
E1	1.650	1.850	0.065	0.073
b	0.200	0.300	0.008	0.012
e	0.500 BSC		0.020 BSC	
k	0.250 REF		0.010 REF	
L	0.300	0.450	0.012	0.018

NOTE: This drawing is subject to change without notice.

TAPE AND REEL INFORMATION

REEL DIMENSIONS



TAPE DIMENSIONS



NOTE: The picture is only for reference. Please make the object as the standard.

KEY PARAMETER LIST OF TAPE AND REEL

Package Type	Reel Diameter	Reel Width W1 (mm)	A0 (mm)	B0 (mm)	K0 (mm)	P0 (mm)	P1 (mm)	P2 (mm)	W (mm)	Pin1 Quadrant
SOIC-8 (Exposed Pad)	13"	12.4	6.40	5.40	2.10	4.0	8.0	2.0	12.0	Q1
TDFN-2×3-8BL	7"	9.5	2.30	3.30	1.10	4.0	4.0	2.0	8.0	Q2

DD0001

PACKAGE INFORMATION

CARTON BOX DIMENSIONS



NOTE: The picture is only for reference. Please make the object as the standard.

KEY PARAMETER LIST OF CARTON BOX

Reel Type	Length (mm)	Width (mm)	Height (mm)	Pizza/Carton
7" (Option)	368	227	224	8
7"	442	410	224	18
13"	386	280	370	5

DD0002