



# SGM8740X

## 42ns, 3V/5V, Single-Supply, Low Power, Rail-to-Rail I/O Comparator

---

### GENERAL DESCRIPTION

The SGM8740X is a single, high speed, low power comparator, which features a fast 42ns propagation delay. The device is optimized for low voltage operation on 3V or 5V supply, and consumes only 155 $\mu$ A supply current.

The SGM8740X supports rail-to-rail input and output operation. The input common mode voltage range is from -0.1V to  $(+V_S) + 0.1V$ , and the output voltage swing is within 210mV of the rails without external pull-up or pull-down resistor. The device can be compatible with CMOS and TTL logics. Any input or output pin has a continuous short-circuit protection to both power supply rails. The SGM8740X has an internal hysteresis for reducing comparator sensitivity to noise, even when the input signals move slowly.

The SGM8740X is available in Green SOT-23-5 and SC70-5 packages. It is rated over the -40 $^{\circ}$ C to +125 $^{\circ}$ C temperature range.

### FEATURES

- **High Speed: 42ns Propagation Delay (10mV Overdrive)**
- **Low Supply Current: 155 $\mu$ A (TYP) at  $V_S = 3V$**
- **Low Offset Voltage: 5.5mV (MAX)**
- **Rail-to-Rail Input and Output**
- **Supply Voltage Range: 2.7V to 5.5V**
- **Optimized for 3V and 5V Applications**
- **Output Swing within 210mV from Rails with 4mA Output Current**
- **Supports CMOS or TTL Logic**
- **Internal Hysteresis for Reducing Comparator Sensitivity to Noise**
- **-40 $^{\circ}$ C to +125 $^{\circ}$ C Operating Temperature Range**
- **Available in Green SOT-23-5 and SC70-5 Packages**

### APPLICATIONS

3V or 5V Applications  
Portable/Battery-Powered Equipment  
Mobile Phones  
Zero-Crossing Detectors  
Threshold Detectors  
Line Receiver Units

**PACKAGE/ORDERING INFORMATION**

MODEL	PACKAGE DESCRIPTION	SPECIFIED TEMPERATURE RANGE	ORDERING NUMBER	PACKAGE MARKING	PACKING OPTION
SGM8740X	SOT-23-5	-40°C to +125°C	SGM8740XN5G/TR	MCFXX	Tape and Reel, 3000
	SC70-5	-40°C to +125°C	SGM8740XC5G/TR	MCGXX	Tape and Reel, 3000

**MARKING INFORMATION**

NOTE: XX = Date Code.

**YYY X X**

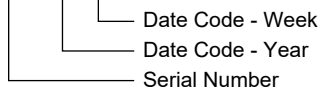

Green (RoHS & HSF): SG Micro Corp defines "Green" to mean Pb-Free (RoHS compatible) and free of halogen substances. If you have additional comments or questions, please contact your SGMICRO representative directly.

**ABSOLUTE MAXIMUM RATINGS**

- Supply Voltage, +V<sub>S</sub> to -V<sub>S</sub> ..... 6V
- Differential Input Voltage, |V<sub>ID</sub>| ..... V<sub>S</sub>
- Voltage at Input/Output Pins ..... (-V<sub>S</sub>) - 0.3V to (+V<sub>S</sub>) + 0.3V
- Junction Temperature ..... +150°C
- Storage Temperature Range ..... -65°C to +150°C
- Lead Temperature (Soldering, 10s) ..... +260°C
- ESD Susceptibility
- HBM ..... 2000V
- CDM ..... 1000V

Failure to observe proper handling and installation procedures can cause damage. ESD damage can range from subtle performance degradation to complete device failure. Precision integrated circuits may be more susceptible to damage because even small parametric changes could cause the device not to meet the published specifications.

**RECOMMENDED OPERATING CONDITIONS**

- Operating Temperature Range ..... -40°C to +125°C

**DISCLAIMER**

SG Micro Corp reserves the right to make any change in circuit design, or specifications without prior notice.

**OVERSTRESS CAUTION**

Stresses beyond those listed in Absolute Maximum Ratings may cause permanent damage to the device. Exposure to absolute maximum rating conditions for extended periods may affect reliability. Functional operation of the device at any conditions beyond those indicated in the Recommended Operating Conditions section is not implied.

**PIN CONFIGURATIONS**

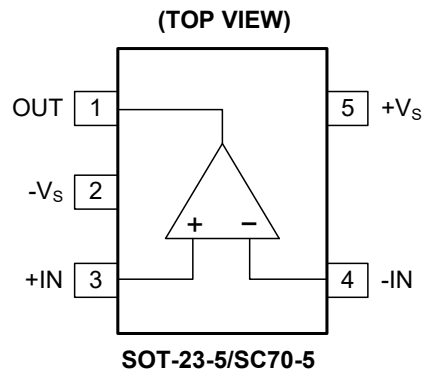

**ESD SENSITIVITY CAUTION**

This integrated circuit can be damaged if ESD protections are not considered carefully. SGMICRO recommends that all integrated circuits be handled with appropriate precautions.

**ELECTRICAL CHARACTERISTICS**(V<sub>S</sub> = 5V, V<sub>CM</sub> = 0V, Full = -40°C to +125°C, typical values are at T<sub>A</sub> = +25°C, unless otherwise noted.)

PARAMETER	SYMBOL	CONDITIONS	TEMP	MIN	TYP	MAX	UNITS
<b>Input Characteristics</b>							
Input Offset Voltage	V <sub>OS</sub>	V <sub>CM</sub> = 0V	+25°C		1	5.5	mV
			Full			6	
Input Bias Current	I <sub>B</sub>	V <sub>S</sub> = 2.7V to 5.5V, V <sub>CM</sub> = V <sub>S</sub> /2	+25°C		10	200	pA
			Full			7000	
Input Offset Current	I <sub>OS</sub>	V <sub>S</sub> = 2.7V to 5.5V, V <sub>CM</sub> = V <sub>S</sub> /2	+25°C		10	200	pA
			Full			1000	
Input Common Mode Voltage Range <sup>(1)</sup>	V <sub>CM</sub>		Full	-0.1		(+V <sub>S</sub> ) + 0.1	V
Common Mode Rejection Ratio	CMRR	V <sub>CM</sub> = 0V to 5V	+25°C	65	78		dB
			Full	62			
Input Hysteresis	V <sub>HYST</sub>	V <sub>CM</sub> = 0V	+25°C		1.2		mV
<b>Output Characteristics</b>							
Output Voltage Swing from Rail	V <sub>OH</sub>	V <sub>CM</sub> = V <sub>S</sub> /2, V <sub>OD</sub> = 100mV, I <sub>OUT</sub> = 4mA	+25°C		210	285	mV
			Full			330	
	V <sub>OL</sub>	V <sub>CM</sub> = V <sub>S</sub> /2, V <sub>OD</sub> = 100mV, I <sub>OUT</sub> = -4mA	+25°C		180	235	
			Full			280	
Output Short-Circuit Current	I <sub>SOURCE</sub>	V <sub>CM</sub> = V <sub>S</sub> /2, V <sub>OD</sub> = 100mV, Out to V <sub>S</sub> /2	+25°C	20	32		mA
			Full	15			
	I <sub>SINK</sub>		+25°C	22	32		
			Full	16			
<b>Power Supply</b>							
Operating Supply Voltage	V <sub>S</sub>		Full	2.7		5.5	V
Power Supply Rejection Ratio	PSRR	V <sub>S</sub> = 2.7V to 5.5V, V <sub>CM</sub> = 0V	+25°C	65	75		dB
			Full	58			
Supply Current	I <sub>S</sub>	V <sub>S</sub> = 3V, V <sub>CM</sub> = V <sub>S</sub> /2, V <sub>OD</sub> = 100mV, V <sub>OUT</sub> = L, I <sub>OUT</sub> = 0mA	+25°C		155	215	μA
			Full			250	
		V <sub>S</sub> = 5V, V <sub>CM</sub> = V <sub>S</sub> /2, V <sub>OD</sub> = 100mV, V <sub>OUT</sub> = L, I <sub>OUT</sub> = 0mA	+25°C		160	230	
			Full			270	

## NOTE:

1. This value is from PD test. For the range of common mode voltage, the maximum input common mode voltage can reach (+V<sub>S</sub>) + 0.1V without any damage to SGM8740X.

**SWITCHING CHARACTERISTICS**(V<sub>S</sub> = 3V, V<sub>CM</sub> = 0V, Full = -40°C to +125°C, typical values are at T<sub>A</sub> = +25°C, unless otherwise noted.)

PARAMETER	SYMBOL	CONDITIONS	TEMP	MIN	TYP	MAX	UNITS
Propagation Delay (High to Low)	t <sub>PHL</sub>	V <sub>OD</sub> = 10mV	+25°C		42		ns
		V <sub>OD</sub> = 100mV	+25°C		24		
Propagation Delay (Low to High)	t <sub>PLH</sub>	V <sub>OD</sub> = 10mV	+25°C		37		ns
		V <sub>OD</sub> = 100mV	+25°C		29		
Rise Time	t <sub>RISE</sub>	V <sub>OD</sub> = 10mV	+25°C		8		ns
		V <sub>OD</sub> = 100mV	+25°C		7		
Fall Time	t <sub>FALL</sub>	V <sub>OD</sub> = 10mV	+25°C		6		ns
		V <sub>OD</sub> = 100mV	+25°C		6		

TYPICAL PERFORMANCE CHARACTERISTICS

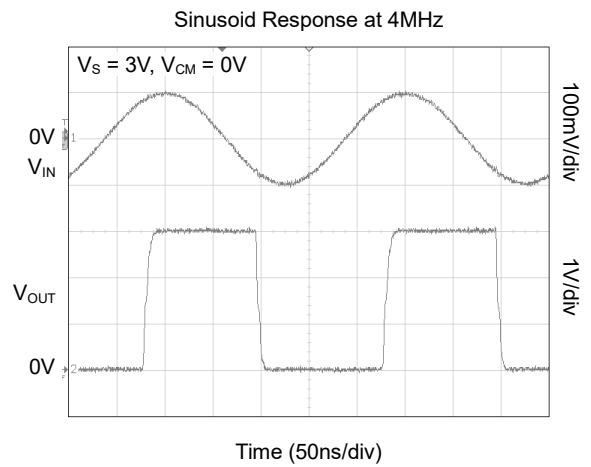
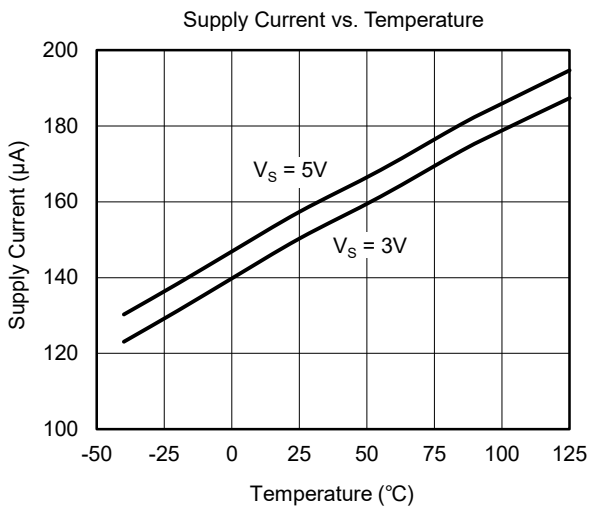
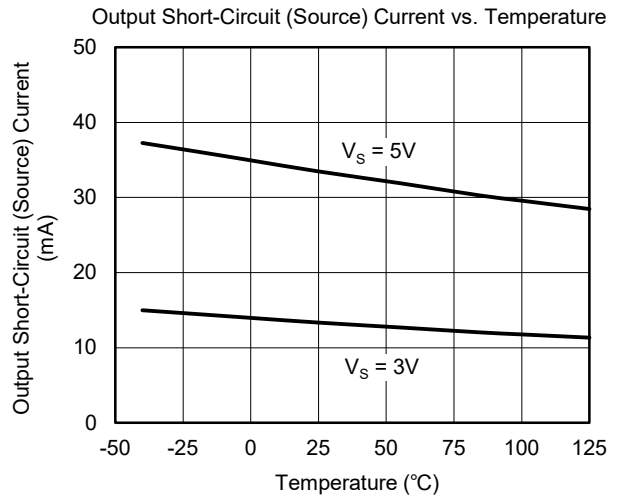
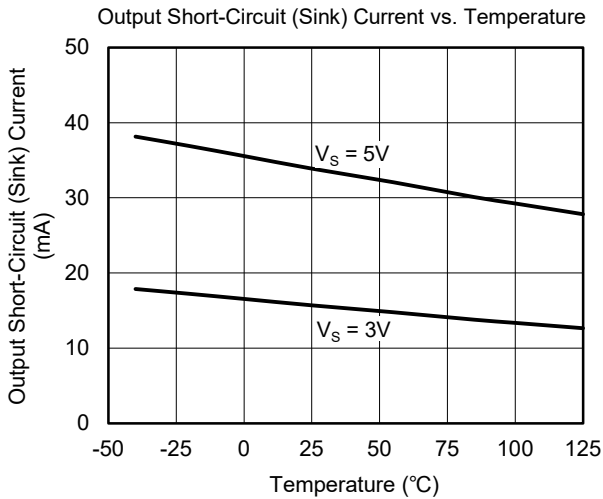
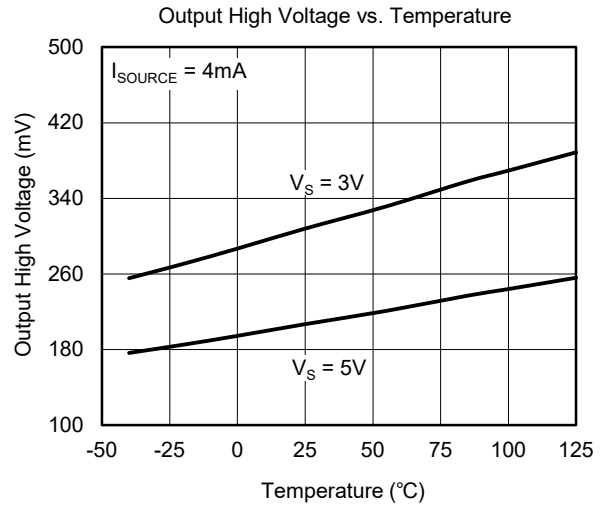
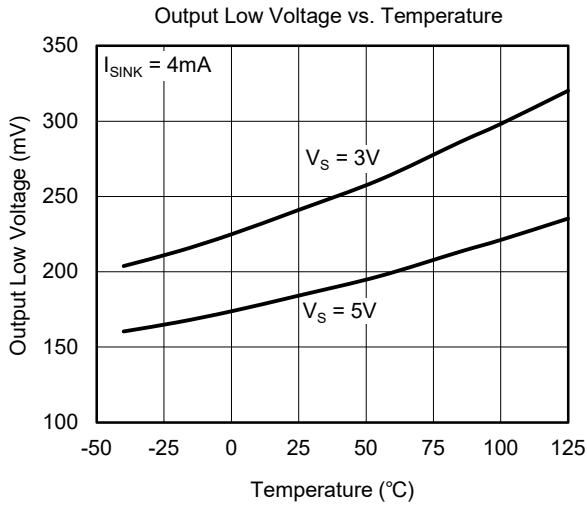

TYPICAL PERFORMANCE CHARACTERISTICS (continued)

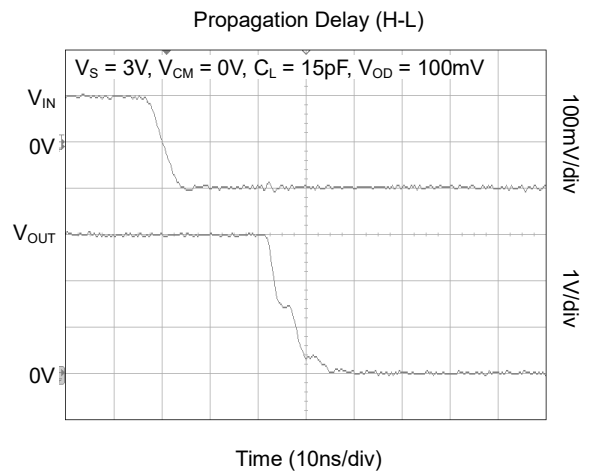
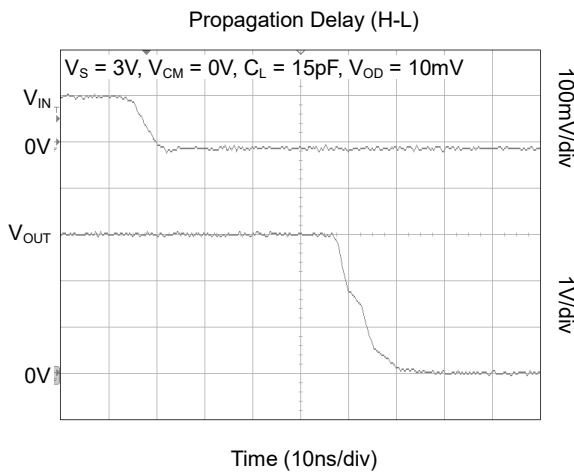
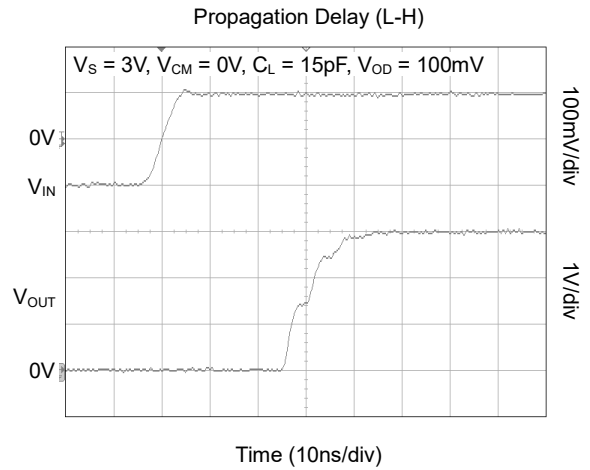
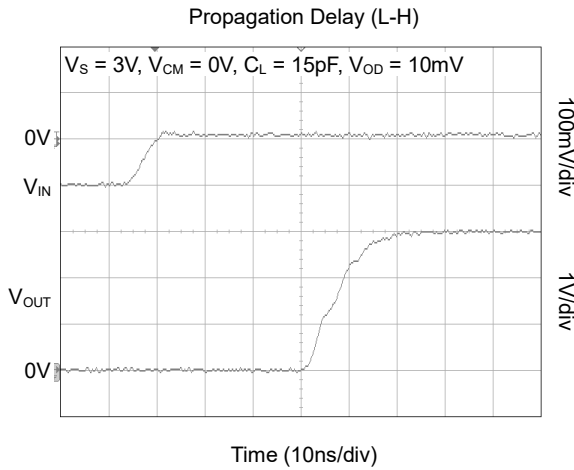
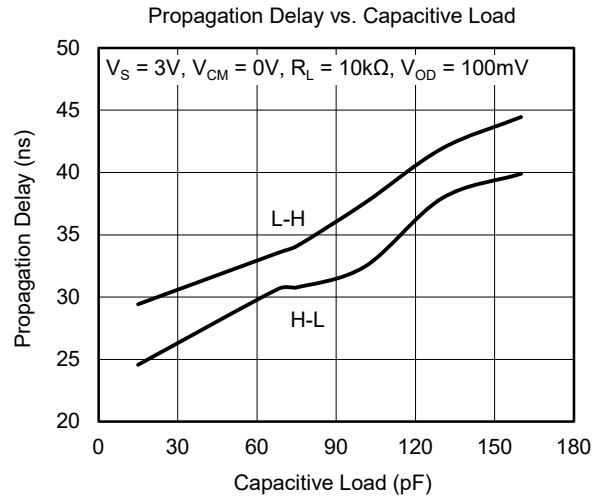
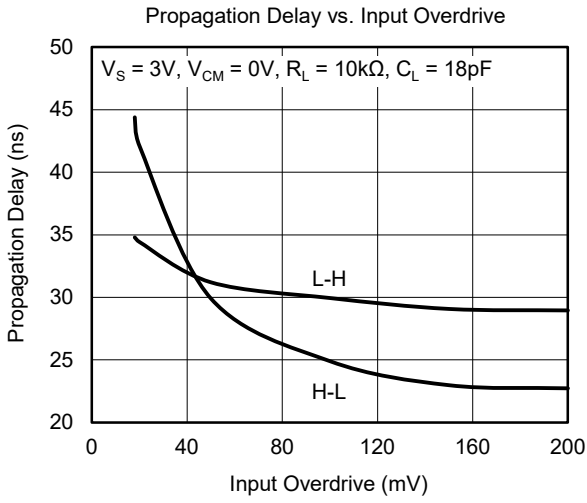

TYPICAL PERFORMANCE CHARACTERISTICS (continued)

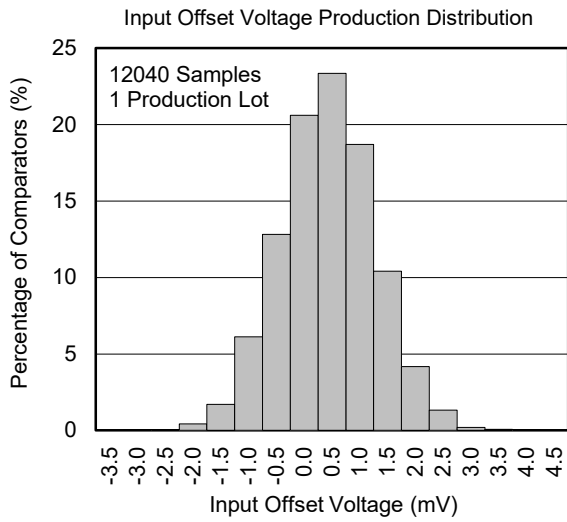

**DETAILED DESCRIPTION**

The SGM8740X is a single, high speed, low power comparator with internal hysteresis. The device is optimized for low voltage operation from 2.7V to 5.5V single supply. It supports rail-to-rail input and output operation. With 4mA output current, the output voltage swing is within 210mV of the rails without external pull-up or pull-down circuitry. The SGM8740X is suitable for portable equipment. It can be compatible with CMOS and TTL logics.

There are a lot of comparators switched frequently for the linear region as the effect of noise and parasitic parameters, and the condition of this negative situation is when the one input of the comparator tends to reach the other input voltage. In order to ease the effect of noise and parasitic parameter, there is a 1.2mV internal hysteresis inside the comparator.

There are two trip points which are made by the comparator: the trip points when rising edge occurs and the trip points when falling edge occurs. And the gap between two trip points is the hysteresis of the comparator. The offset voltage  $V_{OS}$  is defined as the average value of the two trip points. For the condition which two inputs of the comparator are nearly equal, the internal hysteresis will launch to avoid the frequently switching at this case. For the normal comparator other than SGM8740X, the users usually use external resistors connected at +IN pin to provide hysteresis, while the internal hysteresis of SGM8740X can provide internal hysteresis without any external component. However, if users need more hysteresis to reject the influence of noise or parasitic parameters, please add the external resistors at +IN pin to increase the hysteresis.

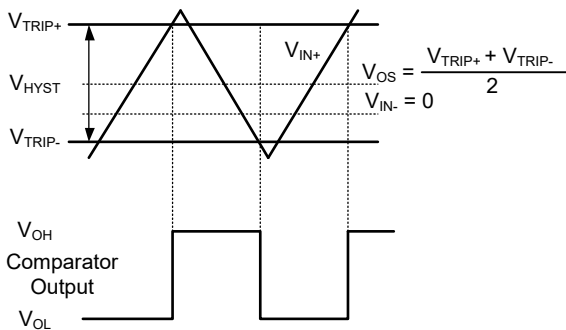

Figure 1. The Waveform for Input and Output, Non-Inverting Input Varied

On the condition shown in Figure 1, the -IN is fixed while +IN is varied, and the corresponding output is shown under the figure of input signal. However, if +IN is fixed while -IN is varied, the output will be inverted.

**Output Structure**

In Figure 2, the SGM8740X has a push-pull output stage. When output is changed from logic high/low to low/high, the changed sink/source current pulls/pushes output pin to logic low/high. Beginning this transition, larger sink/source current is used to create a high slew rate transit from high/low to low/high. Once the output voltage reaches  $V_{OL}/V_{OH}$ , it will reduce the sink/source current to a just right value to maintain the  $V_{OL}/V_{OH}$  static condition. This current-driven push-pull output stage will significantly reduce the power consumption in application system.

If low slew rate transition is needed in system design, adjusting the load capacitance will change the slew rate. The heavier capacitive load will slow down the output voltage transition. This feature will be used to reduce the interference generated by fast edge of transition between 1 and 0 in noise-sensitive system.

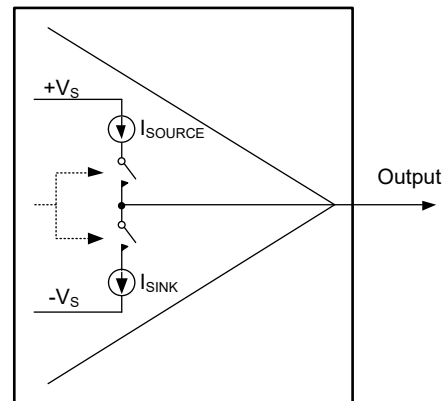
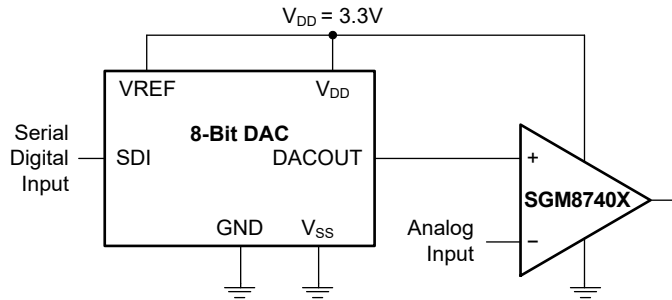

Figure 2. Push-Pull Output Structure



**APPLICATION INFORMATION**

**Application Circuits**



**Figure 3. A Threshold Detector Controlled by 8-Bit DAC**

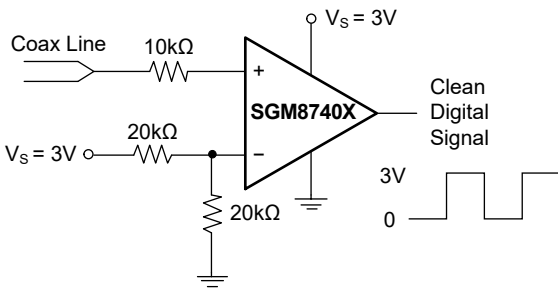

**Figure 4. The Application of Line Receiver**

**Layout and Bypassing**

Good power supply decoupling, layout and grounding are very important for SGM8740X to realize the full high-speed capabilities in system, following skills will be used:

- ◆ A 0.1μF to 4.7μF range ceramic capacitor is used to provide good power supply decoupling. This ceramic capacitor must be placed as close to +V<sub>S</sub> pin as possible.
- ◆ For grounding, unbroken and low-inductance ground plane is a good choice.
- ◆ For Layout, use short PCB trace to avoid unwanted parasitic feedback around the comparator. SGM8740X must be soldered directly to the PCB and the socket is not recommended.

**REVISION HISTORY**

NOTE: Page numbers for previous revisions may differ from page numbers in the current version.

<b>JUNE 2023 – REV.A to REV.A.1</b>	<b>Page</b>
Updated Switching Characteristics section .....	4

---

<b>Changes from Original (NOVEMBER 2022) to REV.A</b>	<b>Page</b>
Changed from product preview to production data.....	All

---

# PACKAGE INFORMATION

## PACKAGE OUTLINE DIMENSIONS

### SOT-23-5

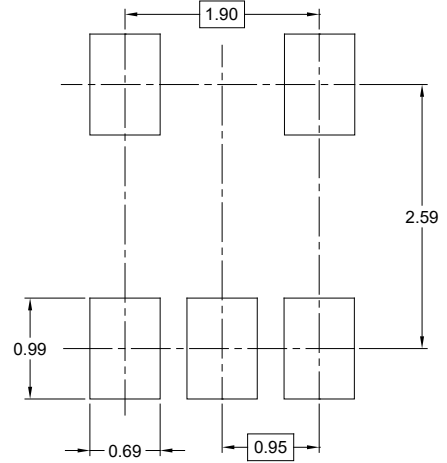
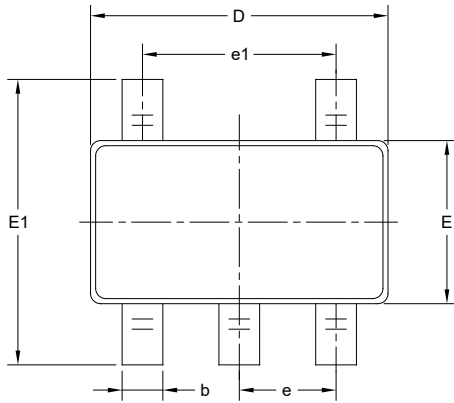

RECOMMENDED LAND PATTERN (Unit: mm)

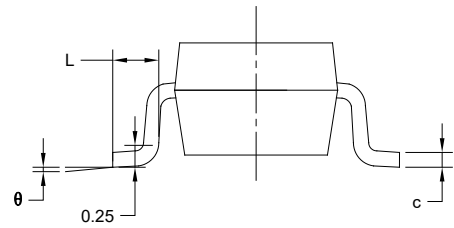
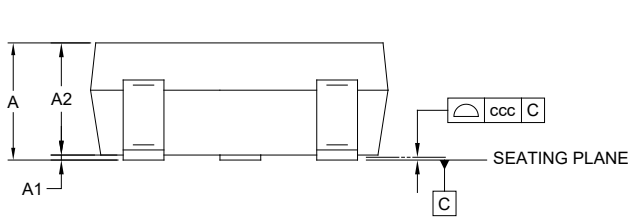

Symbol	Dimensions In Millimeters		
	MIN	MOD	MAX
A	-	-	1.450
A1	0.000	-	0.150
A2	0.900	-	1.300
b	0.300	-	0.500
c	0.080	-	0.220
D	2.750	-	3.050
E	1.450	-	1.750
E1	2.600	-	3.000
e	0.950 BSC		
e1	1.900 BSC		
L	0.300	-	0.600
$\theta$	0°	-	8°
ccc	0.100		

NOTES:

1. This drawing is subject to change without notice.
2. The dimensions do not include mold flashes, protrusions or gate burrs.
3. Reference JEDEC MO-178.

PACKAGE OUTLINE DIMENSIONS

SC70-5

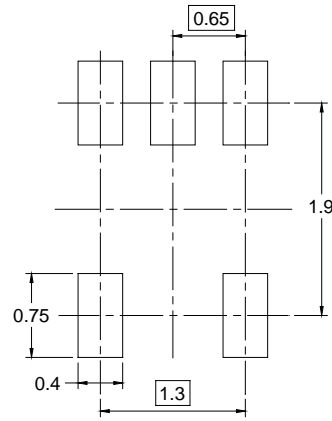
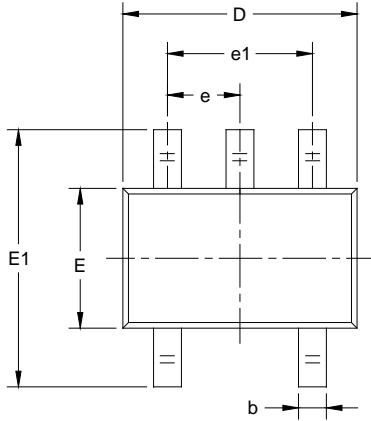

RECOMMENDED LAND PATTERN (Unit: mm)

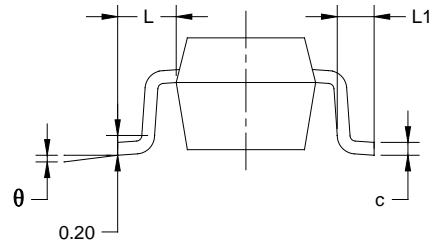
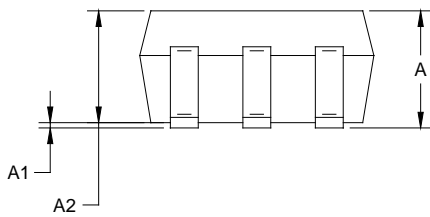

Symbol	Dimensions In Millimeters		Dimensions In Inches	
	MIN	MAX	MIN	MAX
A	0.800	1.100	0.031	0.043
A1	0.000	0.100	0.000	0.004
A2	0.800	1.000	0.031	0.039
b	0.150	0.350	0.006	0.014
c	0.080	0.220	0.003	0.009
D	2.000	2.200	0.079	0.087
E	1.150	1.350	0.045	0.053
E1	2.150	2.450	0.085	0.096
e	0.65 TYP		0.026 TYP	
e1	1.300 BSC		0.051 BSC	
L	0.525 REF		0.021 REF	
L1	0.260	0.460	0.010	0.018
$\theta$	0°	8°	0°	8°

NOTES:

1. Body dimensions do not include mode flash or protrusion.
2. This drawing is subject to change without notice.

## TAPE AND REEL INFORMATION

### REEL DIMENSIONS



### TAPE DIMENSIONS



NOTE: The picture is only for reference. Please make the object as the standard.

### KEY PARAMETER LIST OF TAPE AND REEL

Package Type	Reel Diameter	Reel Width W1 (mm)	A0 (mm)	B0 (mm)	K0 (mm)	P0 (mm)	P1 (mm)	P2 (mm)	W (mm)	Pin1 Quadrant
SOT-23-5	7"	9.5	3.20	3.20	1.40	4.0	4.0	2.0	8.0	Q3
SC70-5	7"	9.5	2.40	2.50	1.20	4.0	4.0	2.0	8.0	Q3

DD0001

# PACKAGE INFORMATION

## CARTON BOX DIMENSIONS



NOTE: The picture is only for reference. Please make the object as the standard.

## KEY PARAMETER LIST OF CARTON BOX

Reel Type	Length (mm)	Width (mm)	Height (mm)	Pizza/Carton
7" (Option)	368	227	224	8
7"	442	410	224	18

DD0002