

### GENERAL DESCRIPTION

The SGM2560 is a dual-channel power distribution switch. The switch operates from a wide range of 2.7V to 5.5V supply voltage, and is controlled by the EN pin. It can be used in USB power distribution applications.

A 90m $\Omega$  low R<sub>ON</sub> N-MOSFET is integrated. The small size and quiescent current make the device very suitable for space limited, battery-powered applications.

A number of protection features are provided in the device including soft-start, current limit and thermal shutdown. The internal reverse-voltage function will protect devices on the input side of the switch. Fault conditions are indicated by the  $\overline{\text{FAULT}}$  pin. Transient faults are filtered internally.

The SGM2560 is available in Green SOIC-8 and TDFN-3 $\times$ 3-8L packages. It is rated over the -40 $^{\circ}$ C to +85 $^{\circ}$ C temperature range.

### FEATURES

- **Input Voltage Range: 2.7V to 5.5V**
- **On-Resistance: 90m $\Omega$  (TYP)**
- **1.1A Current Limit**
- **Quiescent Current: 28 $\mu$ A (Dual-Channel)**
- **1.8V Logic-Controlled Inputs**
- **Full Set of Protections**
  - ◆ **Soft-Start**
  - ◆ **Under-Voltage Lockout for V<sub>IN</sub>**
  - ◆ **No Reversed Leakage Current**
  - ◆ **Short-Circuit Protection**
  - ◆ **Thermally Isolated Channels**
  - ◆ **Fault Status Flag with 4ms Filter Eliminates False Assertions**
- **Evaluated to IEC 60950-1, Ed 2, Am1, Annex CC, Test Program 1 with CB Report**
- **Available in the Green SOIC-8 and TDFN-3 $\times$ 3-8L Packages**

### APPLICATIONS

Hot-Plug Power Supply  
Motherboard USB Power Switch  
Accessories  
Portable Medical Equipment

**PACKAGE/ORDERING INFORMATION**

MODEL	PACKAGE DESCRIPTION	SPECIFIED TEMPERATURE RANGE	ORDERING NUMBER	PACKAGE MARKING	PACKING OPTION
SGM2560A (Active High)	SOIC-8	-40°C to +85°C	SGM2560AYS8G/TR	SGM 2560AYS8 XXXXX	Tape and Reel, 2500
	TDFN-3×3-8L	-40°C to +85°C	SGM2560AYTDB8G/TR	SGM 2560ADB XXXXX	Tape and Reel, 4000
SGM2560B (Active Low)	SOIC-8	-40°C to +85°C	SGM2560BYS8G/TR	SGM 2560BYS8 XXXXX	Tape and Reel, 2500
	TDFN-3×3-8L	-40°C to +85°C	SGM2560BYTDB8G/TR	SGM 2560BDB XXXXX	Tape and Reel, 4000

**MARKING INFORMATION**

NOTE: XXXXX = Date Code and Vendor Code.

**XXXXX**

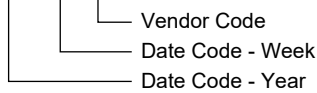

Green (RoHS & HSF): SG Micro Corp defines "Green" to mean Pb-Free (RoHS compatible) and free of halogen substances. If you have additional comments or questions, please contact your SGMICRO representative directly.

**ABSOLUTE MAXIMUM RATINGS**

Input Supply Voltage Range .....	-0.3V to 6V
FAULT Voltage .....	6V
FAULT Current .....	25mA
Output Voltage .....	6V
Output Current .....	Internally Limited
Enable Input .....	-0.3V to $V_{IN}$
Operating Temperature Range .....	-40°C to +85°C
Package Thermal Resistance	
SOIC-8, $\theta_{JA}$ .....	160°C/W
TDFN-3×3-8L, $\theta_{JA}$ .....	65°C/W
Junction Temperature .....	+150°C
Storage Temperature Range .....	-65°C to +150°C
Lead Temperature (Soldering, 10s) .....	+260°C
ESD Susceptibility	
HBM .....	2000V
MM .....	200V

**OVERSTRESS CAUTION**

Stresses beyond those listed in Absolute Maximum Ratings may cause permanent damage to the device. Exposure to absolute maximum rating conditions for extended periods may affect reliability. Functional operation of the device at any conditions beyond those indicated in the Recommended Operating Conditions section is not implied.

**ESD SENSITIVITY CAUTION**

This integrated circuit can be damaged if ESD protections are not considered carefully. SGMICRO recommends that all integrated circuits be handled with appropriate precautions. Failure to observe proper handling and installation procedures can cause damage. ESD damage can range from subtle performance degradation to complete device failure. Precision integrated circuits may be more susceptible to damage because even small parametric changes could cause the device not to meet the published specifications.

**DISCLAIMER**

SG Micro Corp reserves the right to make any change in circuit design, or specifications without prior notice.

PIN CONFIGURATIONS

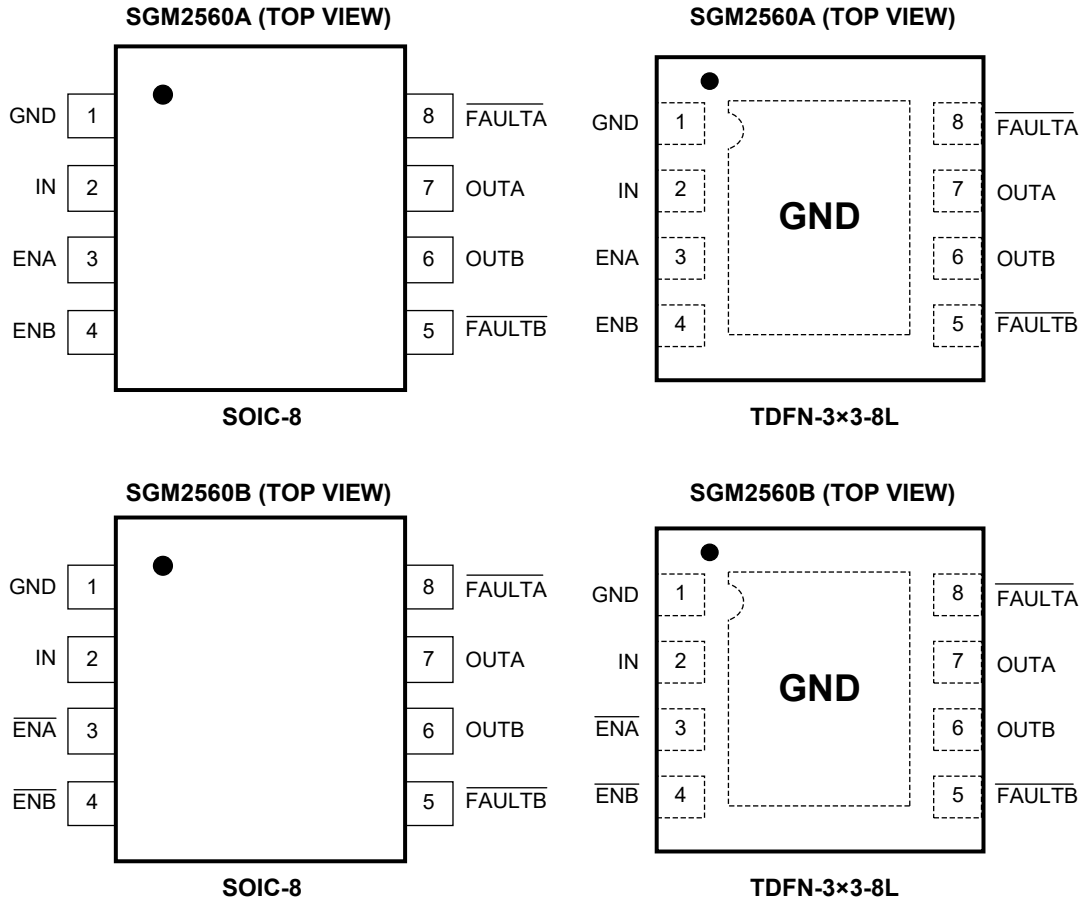

PIN DESCRIPTION

PIN	NAME	FUNCTION
1	GND	Ground.
2	IN	Switch Input.
3	ENA/ $\overline{\text{ENA}}$	Channel A Enable Input. Logic high to enable the SGM2560A (ENA) and logic low to enable the SGM2560B ( $\overline{\text{ENA}}$ ).
4	ENB/ $\overline{\text{ENB}}$	Channel B Enable Input. Logic high to enable the SGM2560A (ENB) and logic low to enable the SGM2560B ( $\overline{\text{ENB}}$ ).
5	$\overline{\text{FAULTB}}$	Fault Flag B. Fault conditions (over-current, thermal shutdown conditions) are indicated by the $\overline{\text{FAULTB}}$ pin. Over-current conditions must last longer than $t_D$ in order to assert $\overline{\text{FAULTB}}$ .
6	OUTB	Channel B Switch Output Pin.
7	OUTA	Channel A Switch Output Pin.
8	$\overline{\text{FAULTA}}$	Fault Flag A. Fault conditions (over-current, thermal shutdown conditions) are indicated by the $\overline{\text{FAULTA}}$ pin. Over-current conditions must last longer than $t_D$ in order to assert $\overline{\text{FAULTA}}$ .

## ELECTRICAL CHARACTERISTICS

(V<sub>IN</sub> = 5V, Full = -40°C to +85°C. Typical values are at T<sub>A</sub> = +25°C, unless otherwise noted.)

PARAMETER	SYMBOL	CONDITIONS	TEMP	MIN	TYP	MAX	UNITS
Input Voltage Range	V <sub>IN</sub>		+25°C	2.7		5.5	V
Quiescent Supply Current	I <sub>Q</sub>	Switch on, OUT = open	+25°C		28	55	μA
Shutdown Supply Current	I <sub>SD</sub>	Switch off, OUT = open	Full		0.1	1	μA
Output Leakage Current	I <sub>LEAKAGE</sub>	Switch off, V <sub>OUT</sub> = 0V	+25°C		0.1	18	μA
Off Current in Latched Thermal Shutdown		Output current during thermal shutdown state	+25°C		30		μA
Enable Input Threshold	V <sub>IH</sub>		+25°C	1.6			V
	V <sub>IL</sub>					0.6	
Enable Input Current	I <sub>EN</sub>	V <sub>ENA</sub> = V <sub>ENB</sub> = 0V to 5V	Full		0.1	1.6	μA
Switch Resistance	R <sub>DS(ON)</sub>	V <sub>IN</sub> = 5V, I <sub>OUT</sub> = 500mA	TDFN-3×3-8L	Full	90	150	mΩ
		V <sub>IN</sub> = 3.3V, I <sub>OUT</sub> = 500mA		Full	95	155	
		V <sub>IN</sub> = 5V, I <sub>OUT</sub> = 500mA	SOIC-8	Full	100	160	
		V <sub>IN</sub> = 3.3V, I <sub>OUT</sub> = 500mA		Full	105	165	
Output Turn-On Delay Time	t <sub>ON</sub>	R <sub>L</sub> = 10Ω, C <sub>OUT</sub> = 1μF, Figure 1	Full		1.9	3.9	ms
Output Turn-On Rise Time	t <sub>R</sub>	R <sub>L</sub> = 10Ω, C <sub>OUT</sub> = 1μF, Figure 2	Full		1.4	2.7	ms
		R <sub>L</sub> = 10Ω, C <sub>OUT</sub> = 1μF, V <sub>IN</sub> = 3.3V, Figure 2	+25°C		1.5		
Output Turn-Off Delay Time	t <sub>OFF</sub>	R <sub>L</sub> = 10Ω, C <sub>OUT</sub> = 1μF, Figure 1	Full		45	90	μs
Output Turn-Off Fall Time	t <sub>F</sub>	R <sub>L</sub> = 10Ω, C <sub>OUT</sub> = 1μF, Figure 2	Full		25	60	μs
Current Limit Threshold	I <sub>LIM</sub>	Ramped Load	+25°C	0.75	1.10	1.45	A
Short-Circuit Output Current	I <sub>SHORT</sub>	V <sub>OUT</sub> = 0V, enabled into short-circuit	+25°C	0.6	0.9	1.2	A
Short-Circuit Response Time	t <sub>SHORT</sub>	V <sub>OUT</sub> = 0V to I <sub>OUT</sub> = I <sub>SHORT</sub> , when output is short-circuited	+25°C		16		μs
Over-Current $\overline{\text{FAULT}}$ Response Delay Time	t <sub>D</sub>	V <sub>IN</sub> = 5V, apply V <sub>OUT</sub> = 0V until $\overline{\text{FAULT}}$ Low	+25°C	1.7	4	6.5	ms
Under-Voltage Lockout Threshold	UVLO	V <sub>IN</sub> Rising	Full	2.25	2.4	2.55	V
		V <sub>IN</sub> Falling	Full	2	2.15	2.3	
$\overline{\text{FAULT}}$ Output Resistance	R <sub>FAULT</sub>	V <sub>IN</sub> = V <sub>FAULT</sub> = 5V, I <sub>FAULT_SINK</sub> = 10mA	+25°C		15		Ω
		V <sub>IN</sub> = V <sub>FAULT</sub> = 3.3V, I <sub>FAULT_SINK</sub> = 10mA	Full		16	35	
$\overline{\text{FAULT}}$ Leakage Current	I <sub>FAULT</sub>	V <sub>IN</sub> = V <sub>FAULT</sub> = 5V	Full		0.1	2	μA
Channel Thermal Shutdown in Current Limit		T <sub>J</sub> increasing			140		°C
Channel Thermal Shutdown in Current Limit Hysteresis					20		
Both Channels Thermal Shutdown Threshold		T <sub>J</sub> increasing, if either channel T <sub>J</sub> > 160°C, both channel outputs will be shut off.			160		
Both Channels Thermal Shutdown Hysteresis					15		

TYPICAL PERFORMANCE CHARACTERISTICS

At  $T_A = +25^\circ\text{C}$ ,  $V_{IN} = 5\text{V}$ , unless otherwise noted.

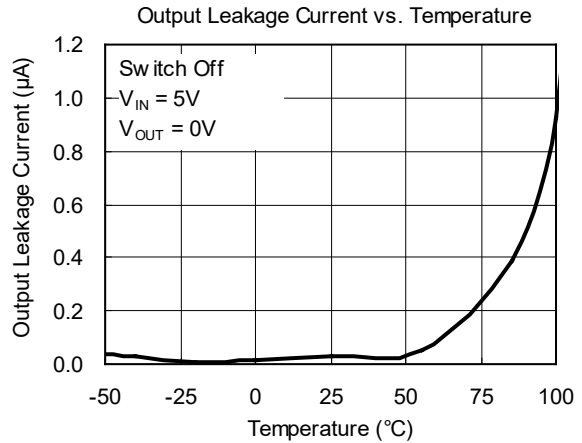
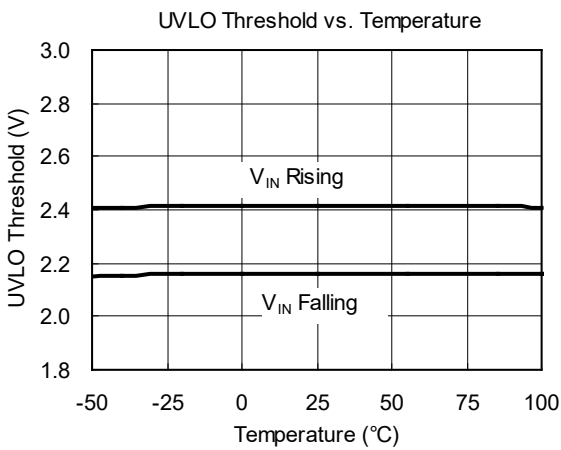
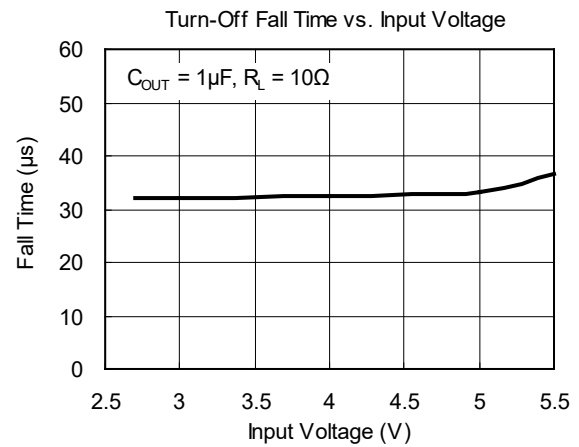
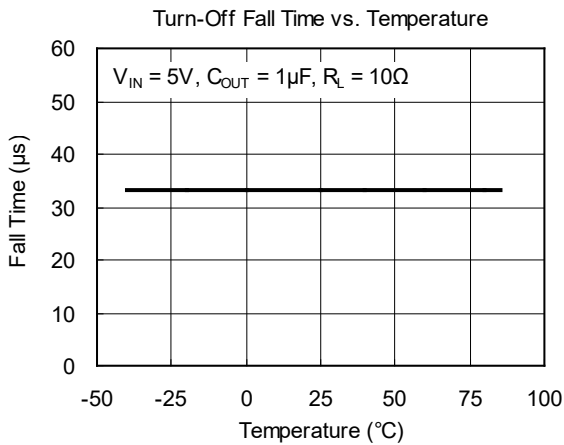
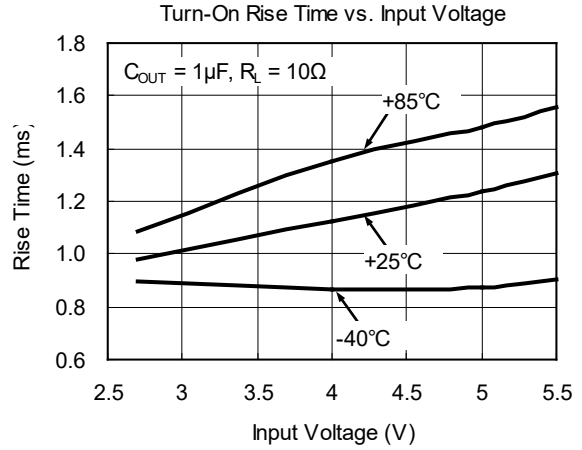
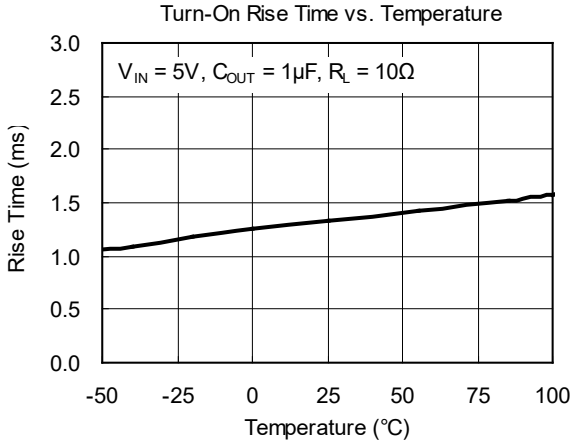

TYPICAL PERFORMANCE CHARACTERISTICS (continued)

At  $T_A = +25^\circ\text{C}$ ,  $V_{IN} = 5\text{V}$ , unless otherwise noted.

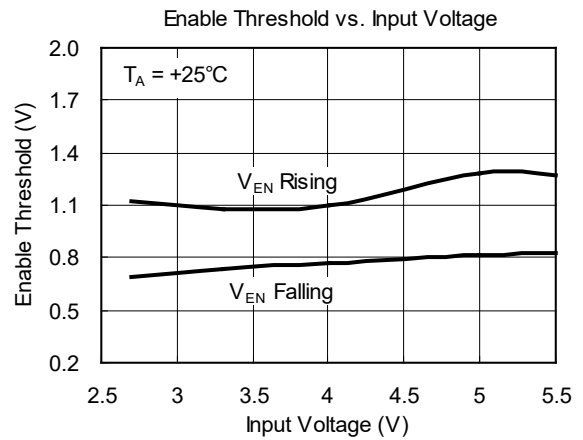
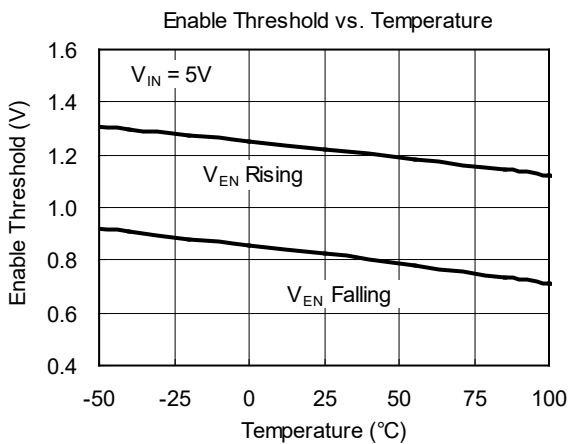
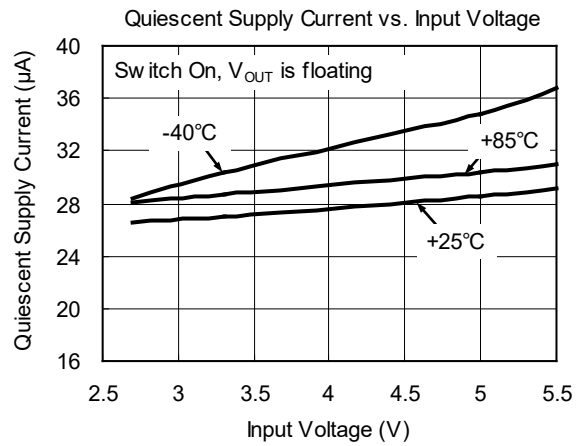
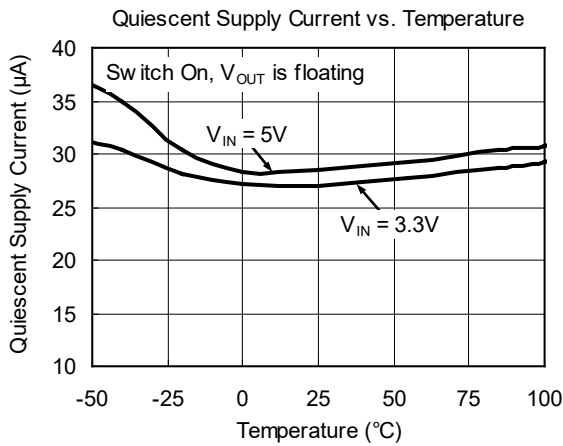
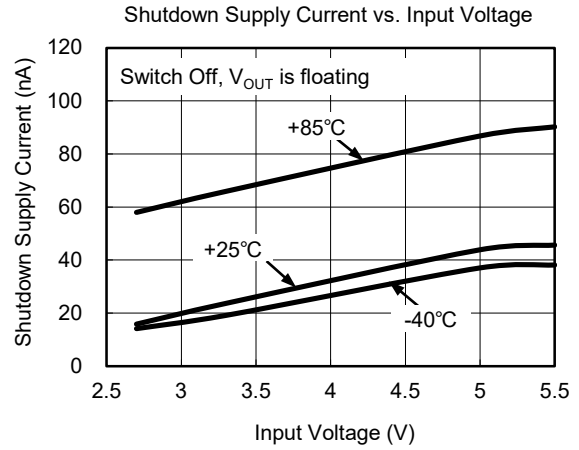
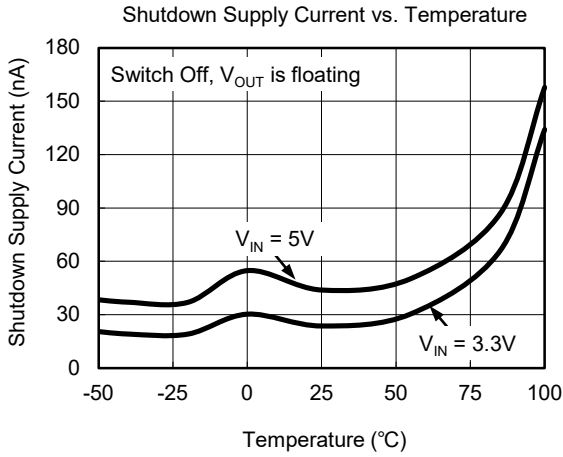

TYPICAL PERFORMANCE CHARACTERISTICS (continued)

At  $T_A = +25^\circ\text{C}$ ,  $V_{IN} = 5\text{V}$ , unless otherwise noted.

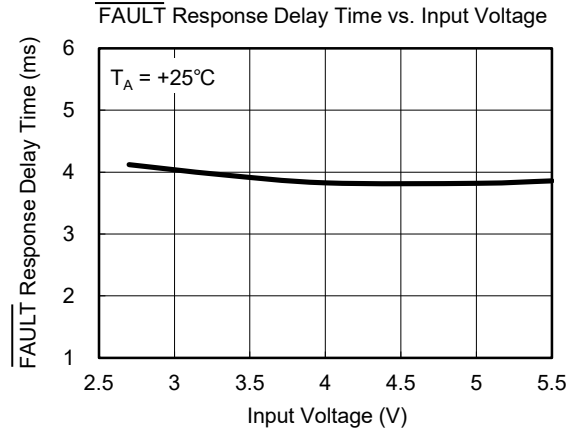
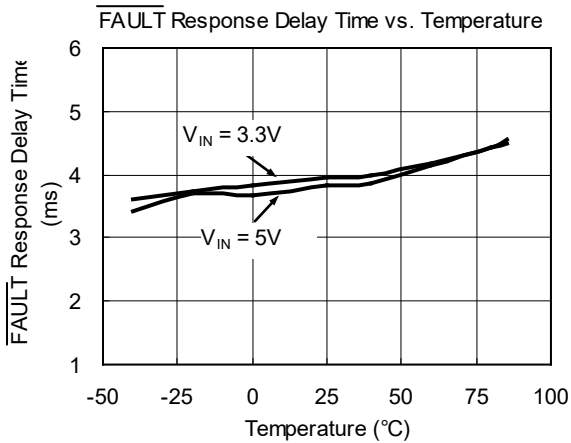
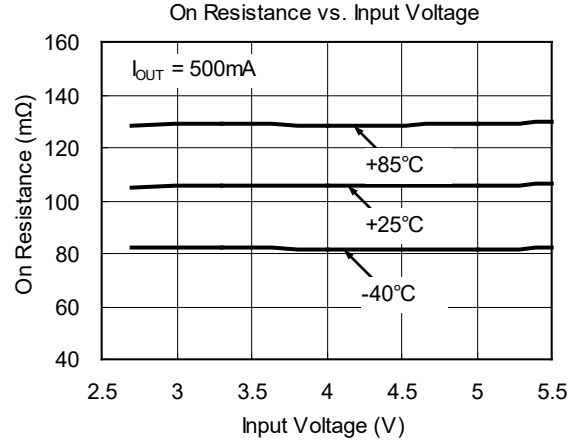
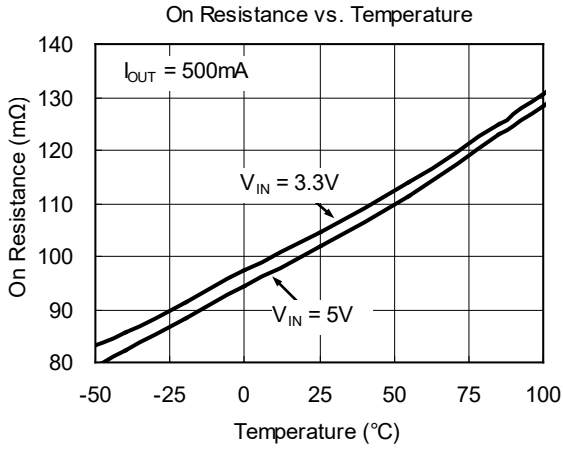

TYPICAL PERFORMANCE CHARACTERISTICS (continued)

At  $T_A = +25^\circ\text{C}$ ,  $V_{IN} = 5\text{V}$ , unless otherwise noted.

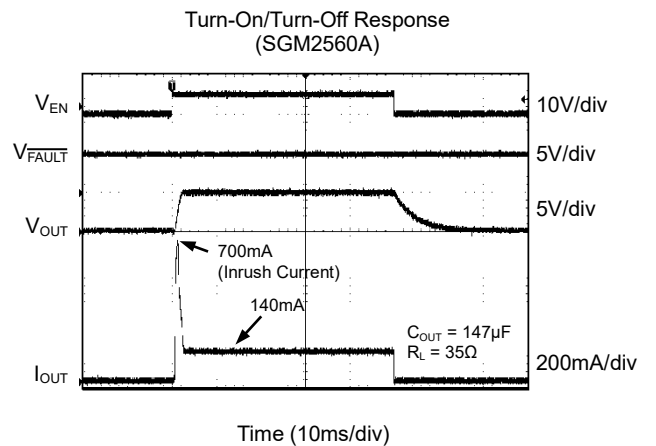
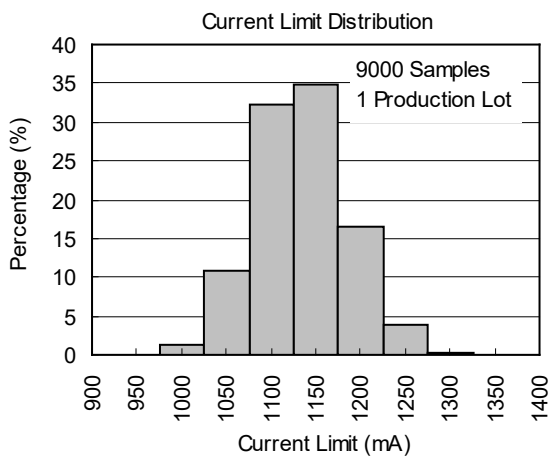
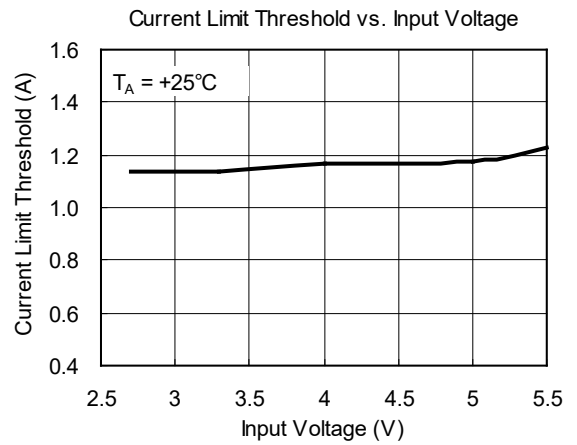
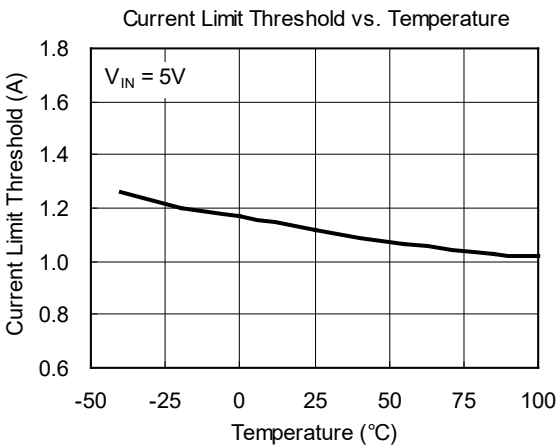
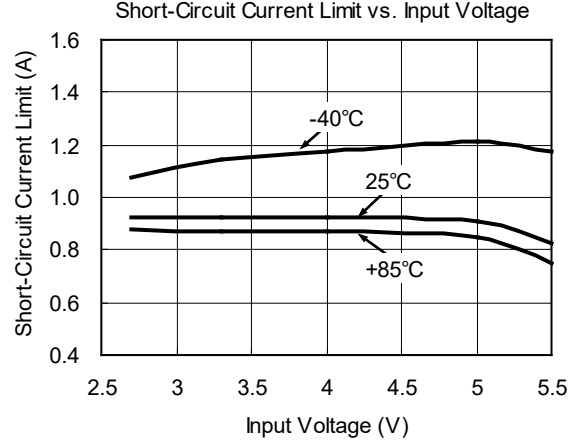
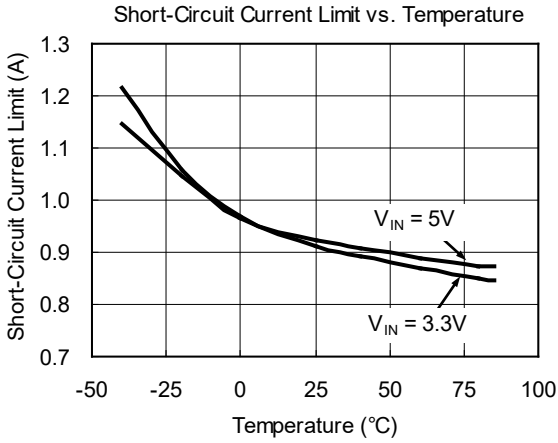



TYPICAL PERFORMANCE CHARACTERISTICS (continued)

At  $T_A = +25^\circ\text{C}$ ,  $V_{IN} = 5\text{V}$ , unless otherwise noted.

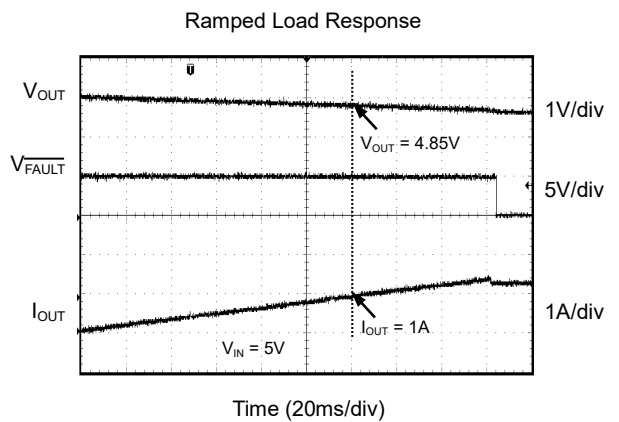
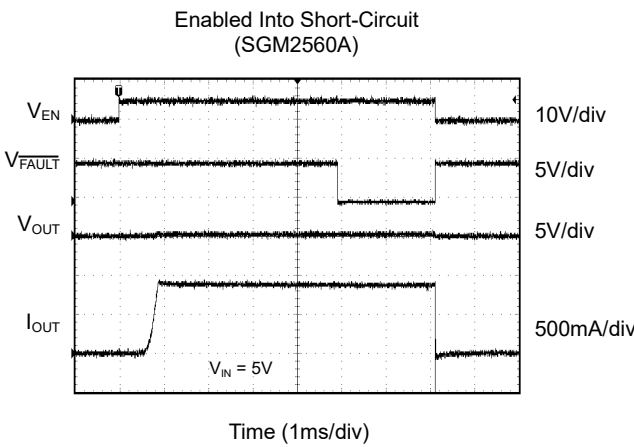
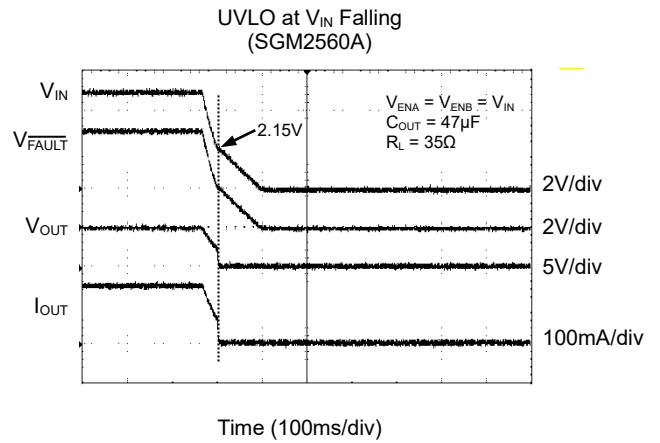
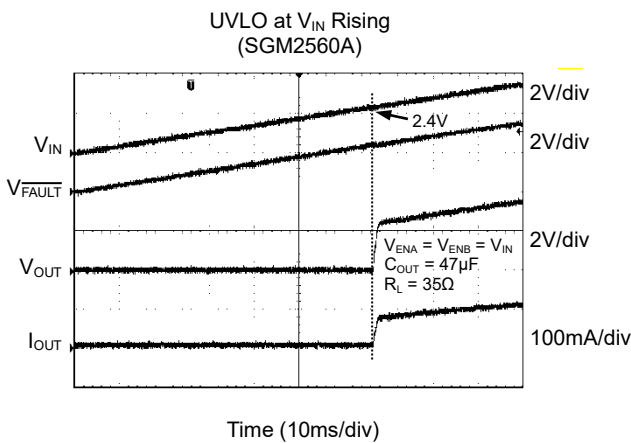
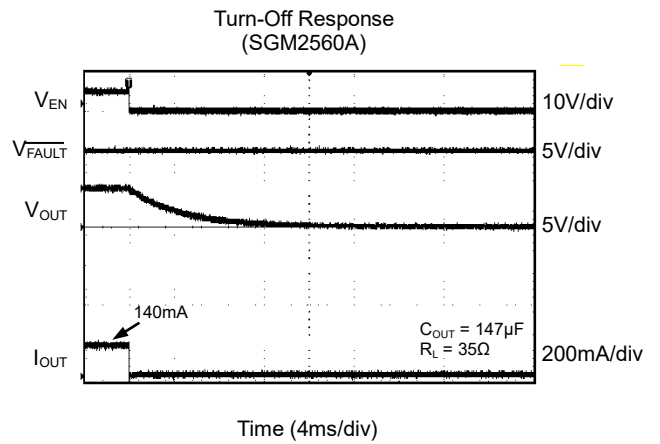
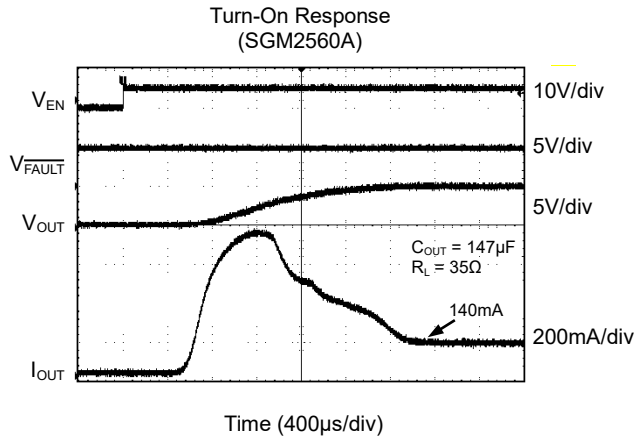

TYPICAL PERFORMANCE CHARACTERISTICS (continued)

At  $T_A = +25^\circ\text{C}$ ,  $V_{IN} = 5\text{V}$ , unless otherwise noted.

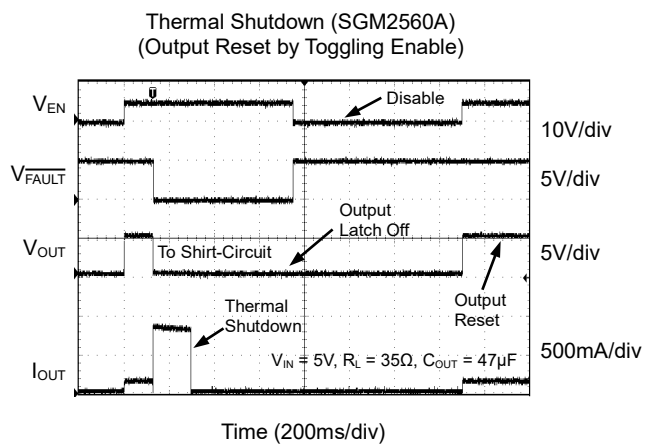
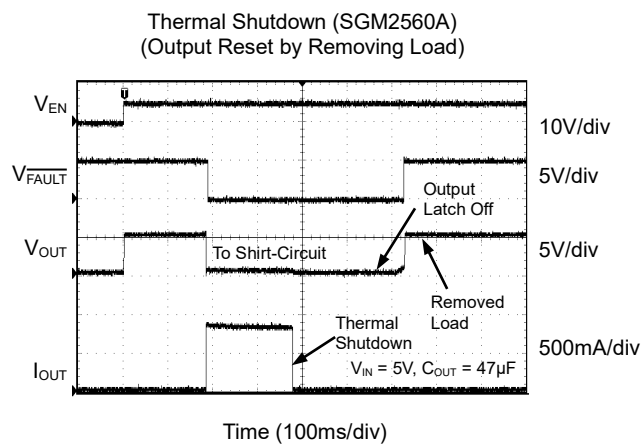
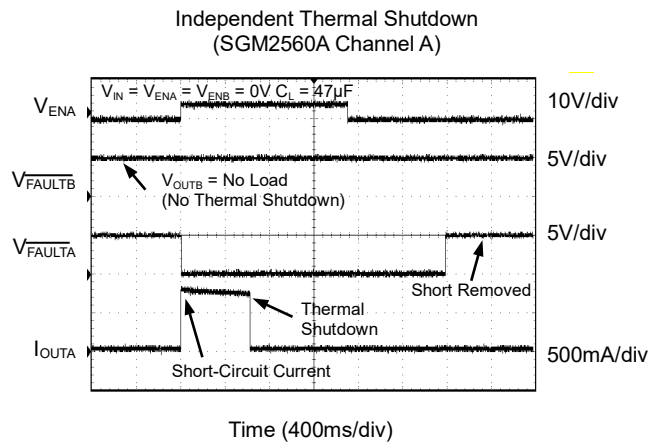
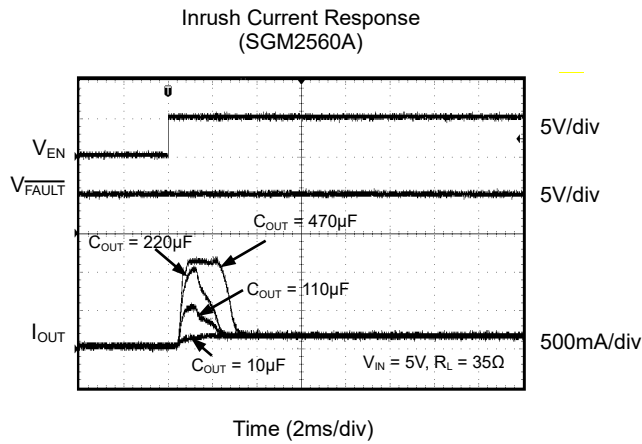
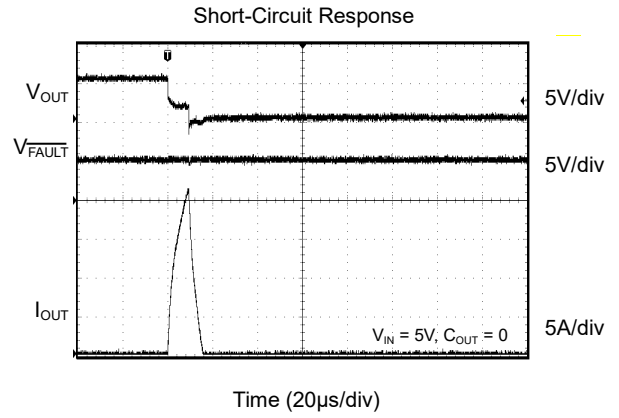
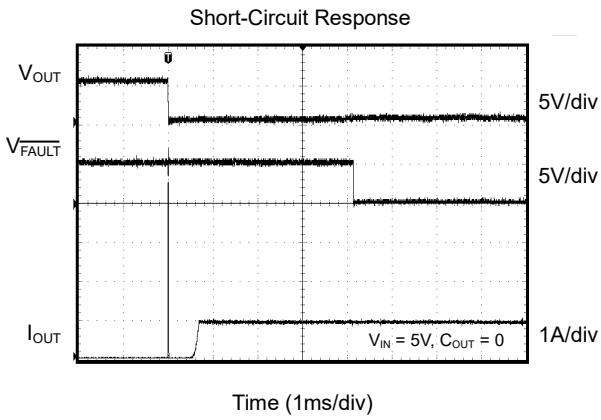

FUNCTIONAL BLOCK DIAGRAM

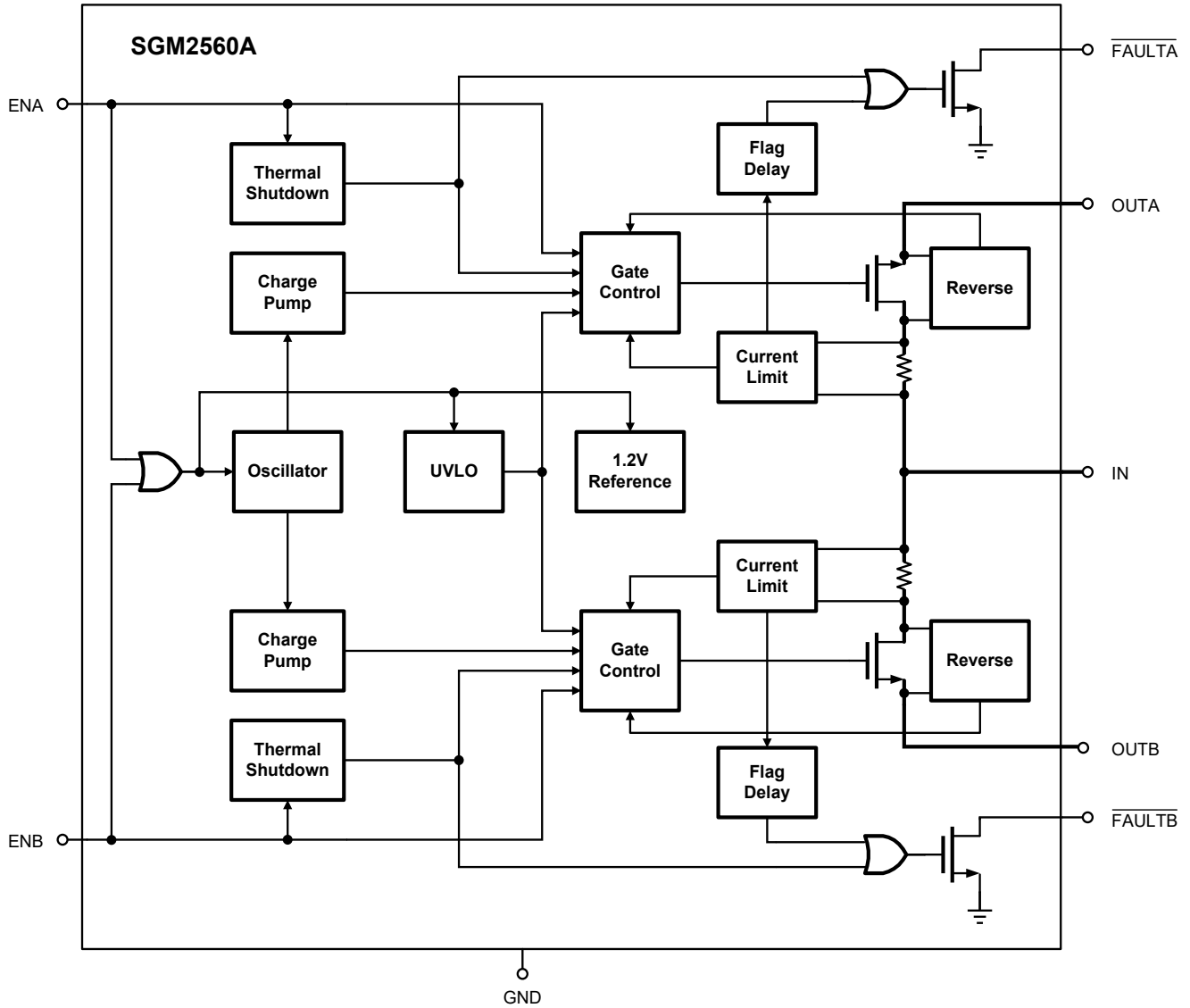

---

**REVISION HISTORY**

NOTE: Page numbers for previous revisions may differ from page numbers in the current version.

**DECEMBER 2017 – REV.A.2 to REV.A.3**

---

Update Feature section ..... 1

---

**AUGUST 2014 – REV.A.1 to REV.A.2**

---

Added SGM2560B..... All

---

**APRIL 2014 – REV.A to REV.A.1**

---

Changed Electrical Characteristics section ..... 4

---

**Changes from Original (FEBRUARY 2014) to REV.A**

---

Changed from product preview to production data..... All

---

PACKAGE OUTLINE DIMENSIONS

SOIC-8

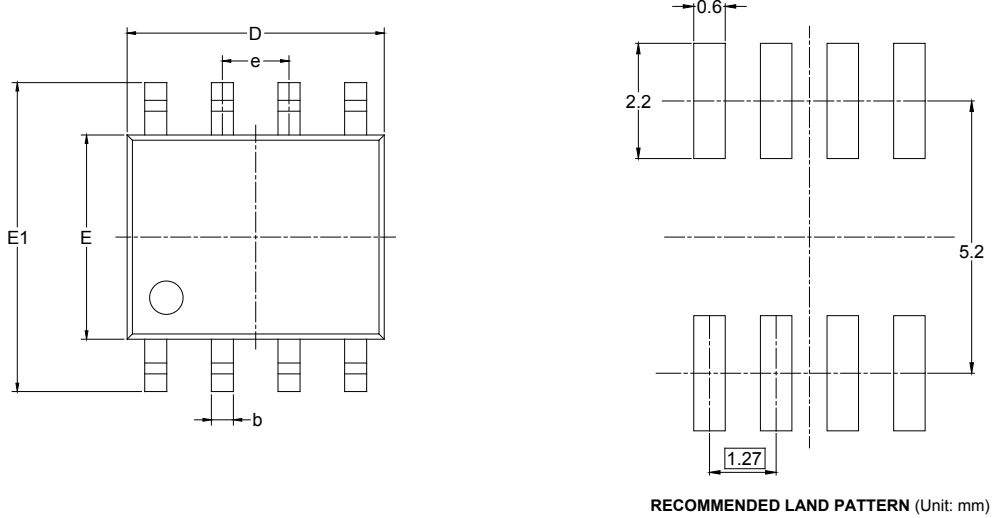

Symbol	Dimensions In Millimeters		Dimensions In Inches	
	MIN	MAX	MIN	MAX
A	1.350	1.750	0.053	0.069
A1	0.100	0.250	0.004	0.010
A2	1.350	1.550	0.053	0.061
b	0.330	0.510	0.013	0.020
c	0.170	0.250	0.006	0.010
D	4.700	5.100	0.185	0.200
E	3.800	4.000	0.150	0.157
E1	5.800	6.200	0.228	0.244
e	1.27 BSC		0.050 BSC	
L	0.400	1.270	0.016	0.050
$\theta$	0°	8°	0°	8°

PACKAGE OUTLINE DIMENSIONS

TDFN-3x3-8L

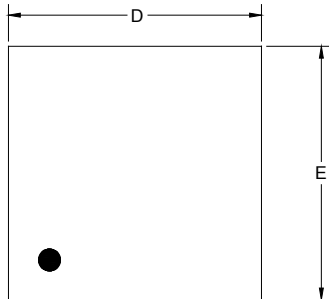

TOP VIEW

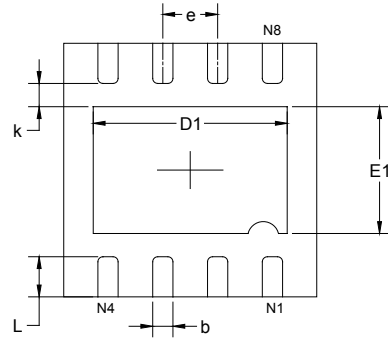

BOTTOM VIEW

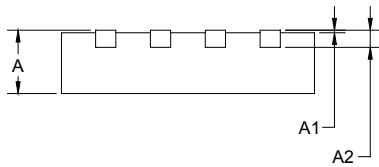

SIDE VIEW

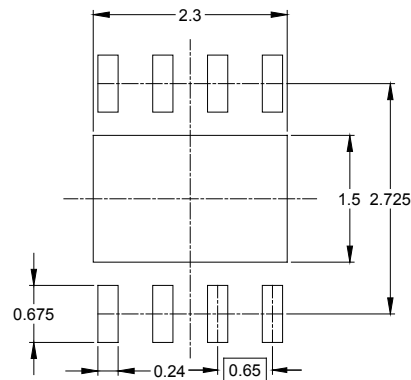

RECOMMENDED LAND PATTERN (Unit: mm)

Symbol	Dimensions In Millimeters		Dimensions In Inches	
	MIN	MAX	MIN	MAX
A	0.700	0.800	0.028	0.031
A1	0.000	0.050	0.000	0.002
A2	0.203 REF		0.008 REF	
D	2.900	3.100	0.114	0.122
D1	2.200	2.400	0.087	0.094
E	2.900	3.100	0.114	0.122
E1	1.400	1.600	0.055	0.063
k	0.200 MIN		0.008 MIN	
b	0.180	0.300	0.007	0.012
e	0.650 TYP		0.026 TYP	
L	0.375	0.575	0.015	0.023

## TAPE AND REEL INFORMATION

### REEL DIMENSIONS



### TAPE DIMENSIONS



NOTE: The picture is only for reference. Please make the object as the standard.

### KEY PARAMETER LIST OF TAPE AND REEL

Package Type	Reel Diameter	Reel Width W1 (mm)	A0 (mm)	B0 (mm)	K0 (mm)	P0 (mm)	P1 (mm)	P2 (mm)	W (mm)	Pin1 Quadrant
SOIC-8	13"	12.4	6.40	5.40	2.10	4.0	8.0	2.0	12.0	Q1
TDFN-3×3-8L	13"	12.4	3.35	3.35	1.13	4.0	8.0	2.0	12.0	Q1

DD0001

# PACKAGE INFORMATION

## CARTON BOX DIMENSIONS



NOTE: The picture is only for reference. Please make the object as the standard.

## KEY PARAMETER LIST OF CARTON BOX

Reel Type	Length (mm)	Width (mm)	Height (mm)	Pizza/Carton
13"	386	280	370	5

DD0002