



SGM8275-1/SGM8275-2 600kHz, Low Noise, High Voltage, Precision Operational Amplifiers

GENERAL DESCRIPTION

The SGM8275-1/2 are a family of single and dual operational amplifiers, which are optimized for high voltage, low noise and low offset voltage operation. These devices can operate from 3.6V to 36V single supply or from $\pm 1.8V$ to $\pm 18V$ dual power supplies, while consuming 0.75mA quiescent current per amplifier.

The SGM8275-1/2 feature a 150 μV maximum input offset voltage. The output swing is rail-to-rail with heavy loads. They exhibit a gain-bandwidth product of 600kHz and a slew rate of 3V/ μs . These specifications make the operational amplifiers appropriate for various applications.

The SGM8275-1 is available in a Green SOT-23-5 package. The SGM8275-2 is available in a Green SOIC-8 package. They are specified over the extended $-40^{\circ}C$ to $+125^{\circ}C$ temperature range.

FEATURES

- **Low Offset Voltage:** 35 μV (TYP), 150 μV (MAX)
- **Low Bias Current:** $\pm 1nA$ (TYP)
- **High Open-Loop Voltage Gain:** 130dB at $V_S = \pm 15V$
- **High PSRR:** 135dB
- **Gain-Bandwidth Product:** 600kHz
- **Low Noise:** 8.5nV/ \sqrt{Hz} at 1kHz
- **Rail-to-Rail Output**
- **Supply Voltage Range:**
3.6V to 36V or $\pm 1.8V$ to $\pm 18V$
- **Input Common Mode Voltage Range:**
 $(-V_S) + 1.5V$ to $(+V_S) - 2V$
- **Low Quiescent Current:** 0.75mA/Amplifier (TYP)
- **$-40^{\circ}C$ to $+125^{\circ}C$ Operating Temperature Range**
- **Small Packaging:**
SGM8275-1 Available in a Green SOT-23-5 Package
SGM8275-2 Available in a Green SOIC-8 Package

APPLICATIONS

Sensors
Audio
Active Filters
A/D Converters
Communications
Test Equipment
Cellular and Cordless Phones
Laptops and PDAs
Photodiode Amplification

PACKAGE/ORDERING INFORMATION

MODEL	PACKAGE DESCRIPTION	SPECIFIED TEMPERATURE RANGE	ORDERING NUMBER	PACKAGE MARKING	PACKING OPTION
SGM8275-1	SOT-23-5	-40°C to +125°C	SGM8275-1XN5G/TR	G05XX	Tape and Reel, 3000
SGM8275-2	SOIC-8	-40°C to +125°C	SGM8275-2XS8G/TR	SGM 82752XS8 XXXXX	Tape and Reel, 2500

MARKING INFORMATION

NOTE: XX = Date Code. XXXXX = Date Code and Vendor Code.

SOT-23-5

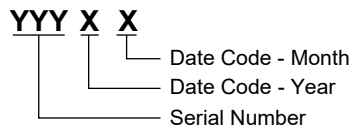

SOIC-8

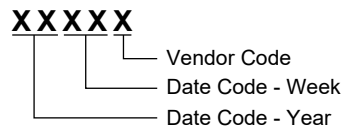

Green (RoHS & HSF): SG Micro Corp defines "Green" to mean Pb-Free (RoHS compatible) and free of halogen substances. If you have additional comments or questions, please contact your SGMICRO representative directly.

ABSOLUTE MAXIMUM RATINGS

- Supply Voltage, +V_S to -V_S 40V
- Input Common Mode Voltage Range (-V_S) - 0.3V to (+V_S) + 0.3V
- Junction Temperature +150°C
- Storage Temperature Range -65°C to +150°C
- Lead Temperature (Soldering, 10s) +260°C
- ESD Susceptibility
- HBM 4000V
- CDM 1000V

ESD SENSITIVITY CAUTION

This integrated circuit can be damaged if ESD protections are not considered carefully. SGMICRO recommends that all integrated circuits be handled with appropriate precautions. Failure to observe proper handling and installation procedures can cause damage. ESD damage can range from subtle performance degradation to complete device failure. Precision integrated circuits may be more susceptible to damage because even small parametric changes could cause the device not to meet the published specifications.

RECOMMENDED OPERATING CONDITIONS

- Supply Voltage Range 3.6V to 36V
- Operating Temperature Range -40°C to +125°C

DISCLAIMER

SG Micro Corp reserves the right to make any change in circuit design, or specifications without prior notice.

OVERSTRESS CAUTION

Stresses beyond those listed in Absolute Maximum Ratings may cause permanent damage to the device. Exposure to absolute maximum rating conditions for extended periods may affect reliability. Functional operation of the device at any conditions beyond those indicated in the Recommended Operating Conditions section is not implied.

PIN CONFIGURATIONS

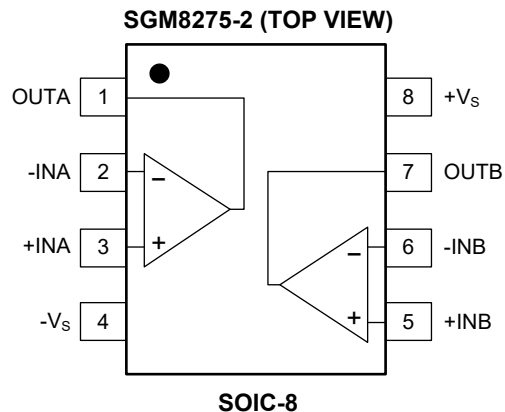
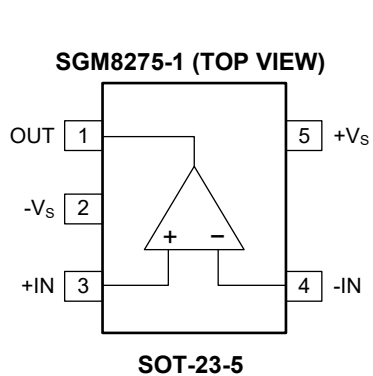

ELECTRICAL CHARACTERISTICS

($V_S = \pm 5V$ to $\pm 15V$, $V_{CM} = 0V$ and $R_L = 2k\Omega$ connected to $0V$, Full = $-40^\circ C$ to $+125^\circ C$, typical values are at $T_A = +25^\circ C$, unless otherwise noted.)

PARAMETER	SYMBOL	CONDITIONS	TEMP	MIN	TYP	MAX	UNITS
Input Characteristics							
Input Offset Voltage	V_{OS}		+25°C		35	150	μV
			Full			250	
Input Offset Voltage Drift	$\Delta V_{OS}/\Delta T$		Full		0.3		$\mu V/^\circ C$
Input Bias Current	I_B		+25°C		± 1	± 12	nA
			Full			± 60	
Input Offset Current	I_{OS}		+25°C		± 1	± 12	nA
			Full			± 35	
Input Common Mode Voltage Range	V_{CM}		Full	$(-V_S) + 1.5$		$(+V_S) - 2$	V
Common Mode Rejection Ratio	CMRR	$(-V_S) + 1.5V \leq V_{CM} \leq (+V_S) - 2V$	+25°C	120	140		dB
			Full	115			
Open-Loop Voltage Gain	A_{OL}	$V_S = \pm 5V, V_{OUT} = \pm 2.5V, R_L = 10k\Omega$	+25°C	115	135		dB
			Full	112			
		$V_S = \pm 15V, V_{OUT} = \pm 10V, R_L = 10k\Omega$	+25°C	120	135		
			Full	117			
		$V_S = \pm 5V, V_{OUT} = \pm 2.5V, R_L = 2k\Omega$	+25°C	110	124		
			Full	105			
		$V_S = \pm 15V, V_{OUT} = \pm 10V, R_L = 2k\Omega$	+25°C	120	130		
			Full	112			
Output Characteristics							
Output Voltage Swing from Rail		$V_S = \pm 15V, R_L = 10k\Omega$	+25°C		90	120	mV
			Full			165	
		$V_S = \pm 15V, R_L = 2k\Omega$	+25°C		450	600	
			Full			820	
Output Short-Circuit Current	I_{SC}	$V_S = \pm 15V$	+25°C	± 21	± 34		mA
Power Supply							
Operating Voltage Range	V_S		Full	3.6		36	V
Quiescent Current/Amplifier	I_Q	$I_{OUT} = 0A$	+25°C		0.75	0.9	mA
			Full			1	
Power Supply Rejection Ratio	PSRR	$V_S = 3V$ to $38V$	+25°C	123	135		dB
			Full	120			
Dynamic Performance							
Gain-Bandwidth Product	GBP	$V_{OUT} = 100mV_{P-P}, C_L = 10pF$	+25°C		600		kHz
Phase Margin	ϕ_O	$V_{OUT} = 100mV_{P-P}, C_L = 10pF$	+25°C		60		°
Slew Rate	SR	$R_L = 2k\Omega$	+25°C		3		V/ μs
Settling Time to 0.1%	t_s	$V_{IN} = 1V$ step, $G = +1$	+25°C		3.5		μs
Overload Recovery Time		$V_{IN} \times G = V_S$	+25°C		1.5		μs
Total Harmonic Distortion + Noise	THD+N	$V_{IN} = 1V_{RMS}, G = +1, f = 1kHz$	+25°C		0.0008		%
Noise							
Input Voltage Noise		$f = 0.1Hz$ to $10Hz$	+25°C		300		nV_{P-P}
Input Voltage Noise Density	e_n	$f = 1kHz$	+25°C		8.5		nV/\sqrt{Hz}
Input Current Noise Density	i_n	$f = 1kHz$	+25°C		1.5		pA/\sqrt{Hz}

TYPICAL PERFORMANCE CHARACTERISTICS

At $T_A = +25^\circ\text{C}$, $V_S = \pm 15\text{V}$ and $R_L = 2\text{k}\Omega$, unless otherwise noted.

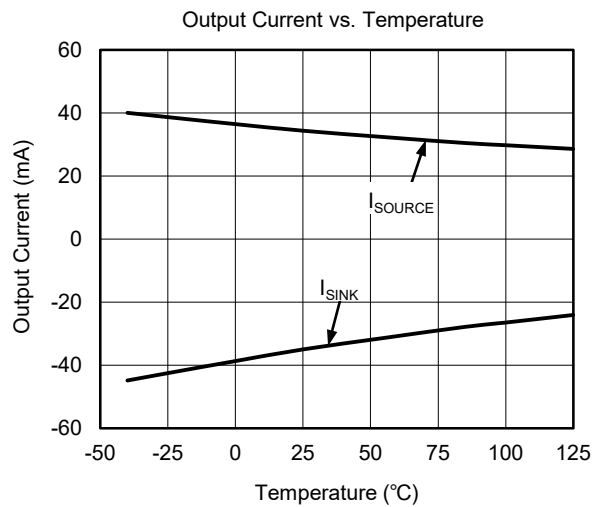
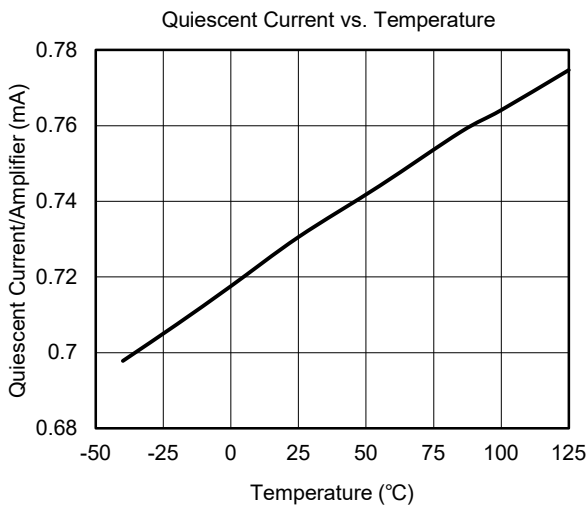
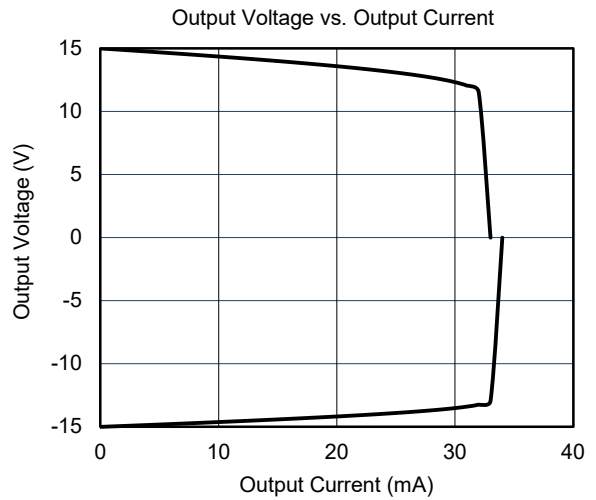
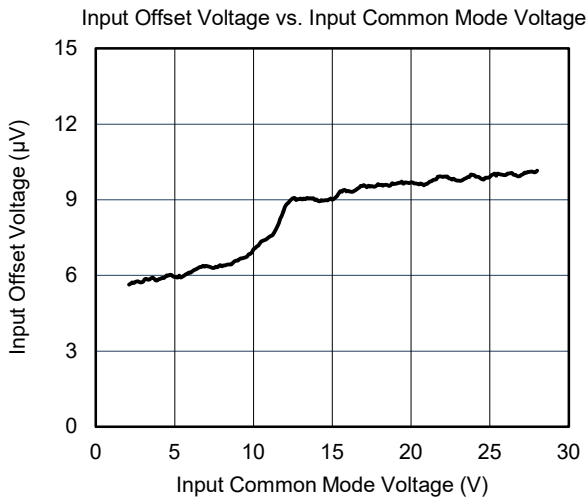
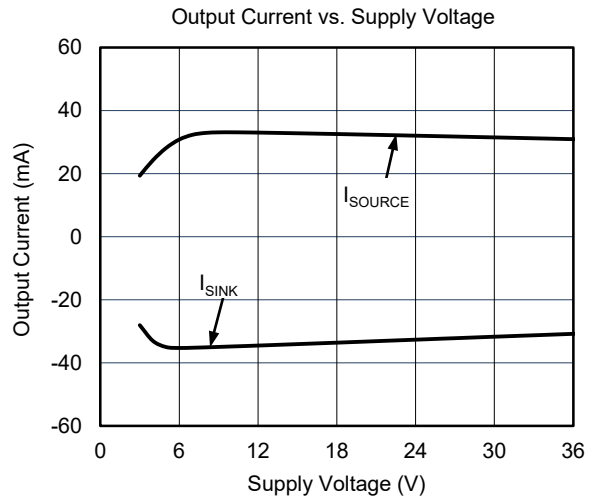
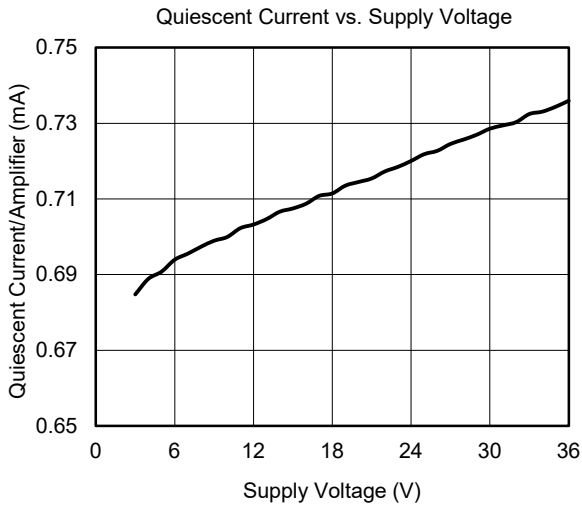

TYPICAL PERFORMANCE CHARACTERISTICS (continued)

At $T_A = +25^\circ\text{C}$, $V_S = \pm 15\text{V}$ and $R_L = 2\text{k}\Omega$, unless otherwise noted.

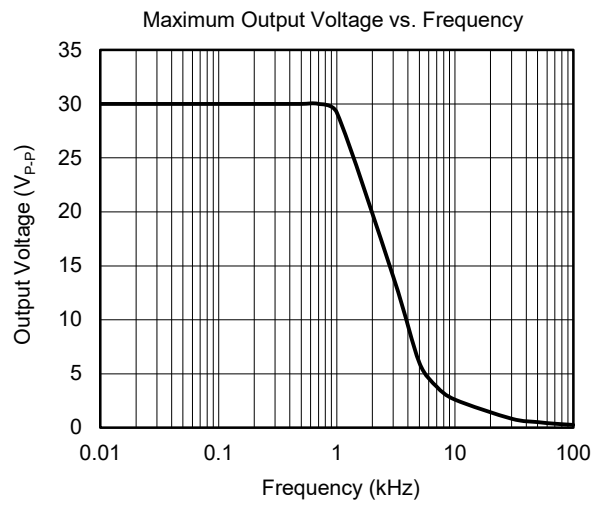
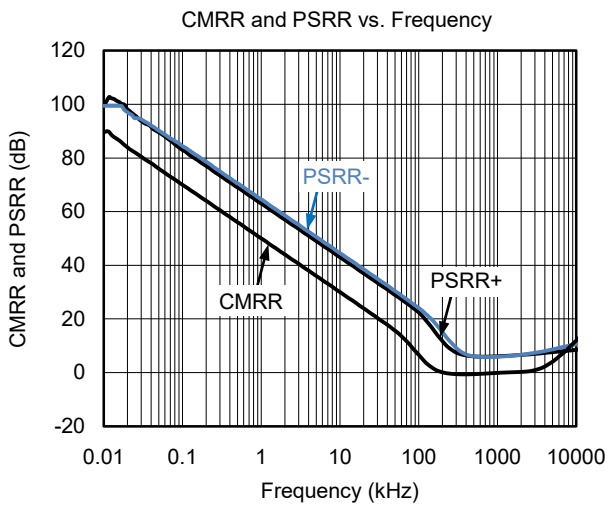
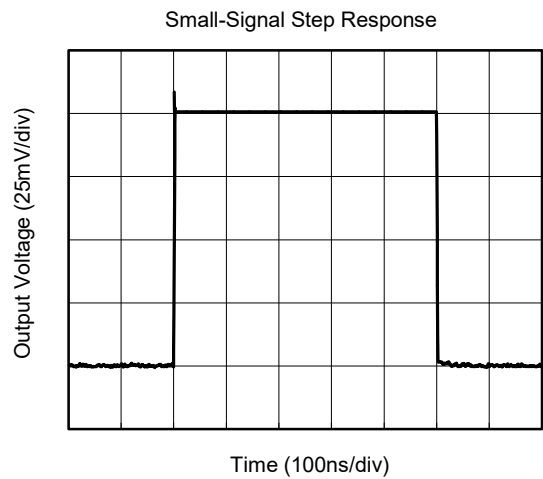
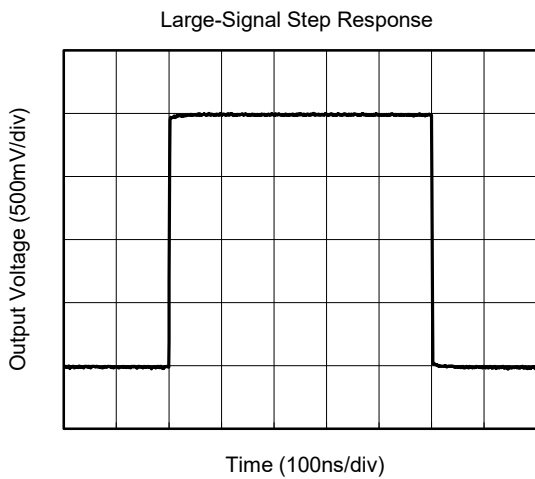
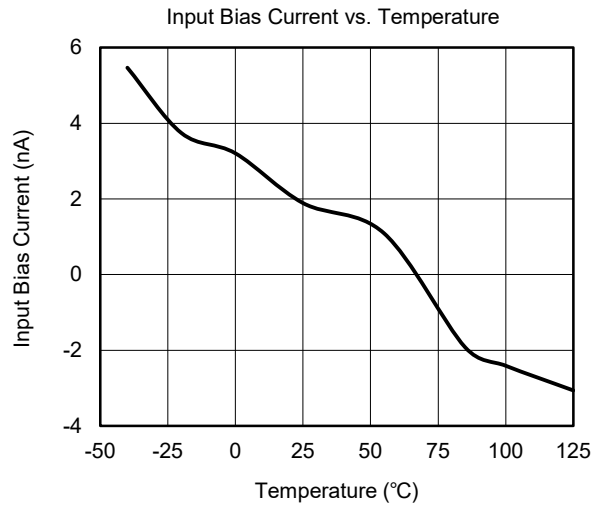
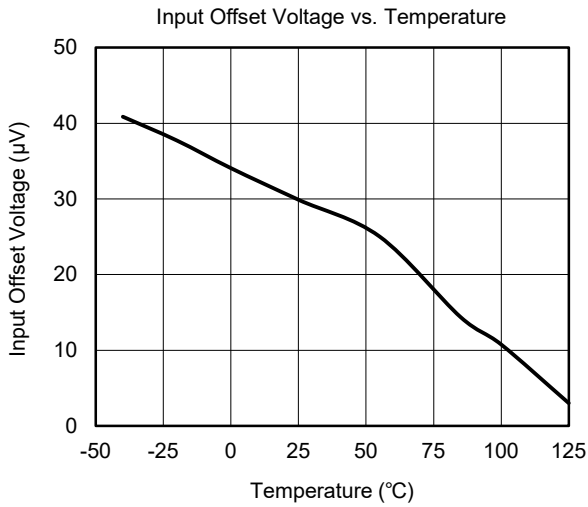

TYPICAL PERFORMANCE CHARACTERISTICS (continued)

At $T_A = +25^\circ\text{C}$, $V_S = \pm 15\text{V}$ and $R_L = 2\text{k}\Omega$, unless otherwise noted.

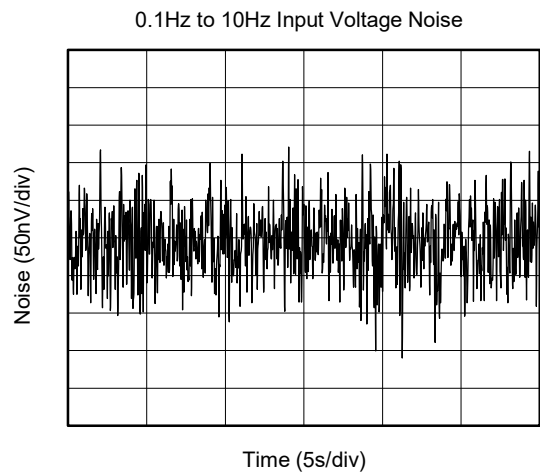
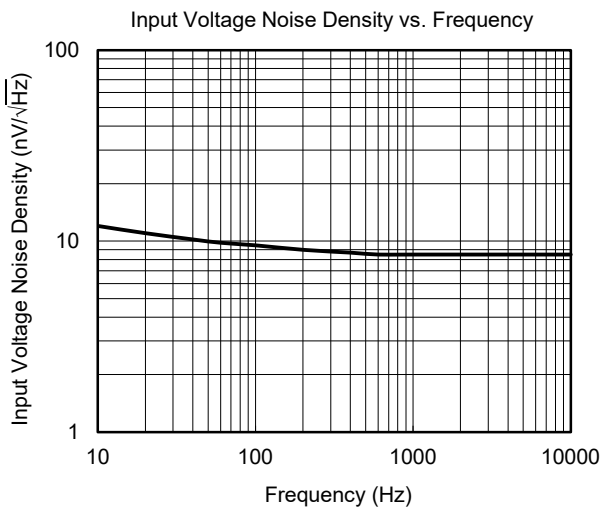
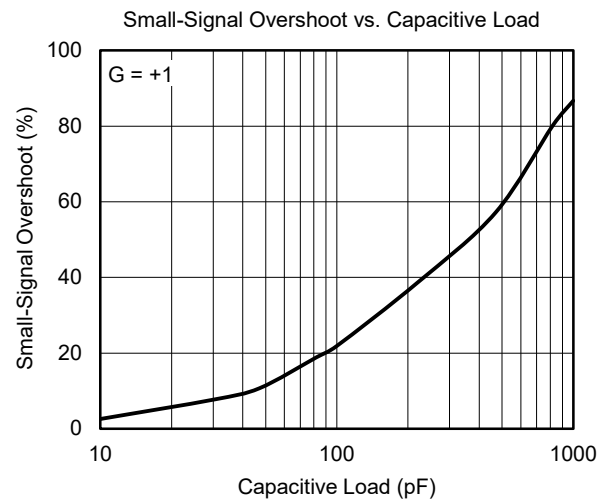
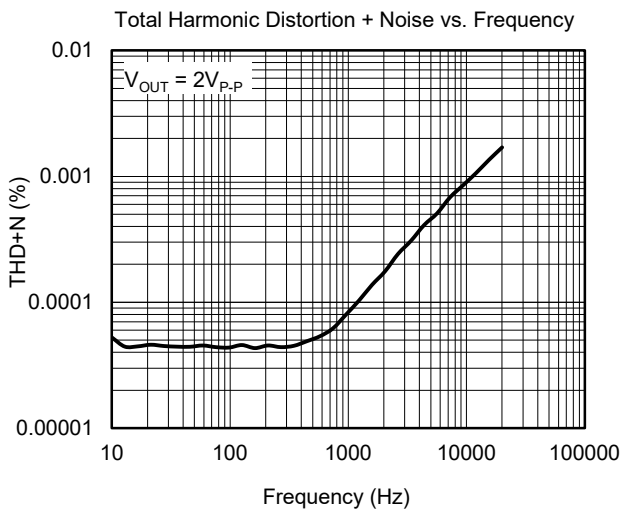
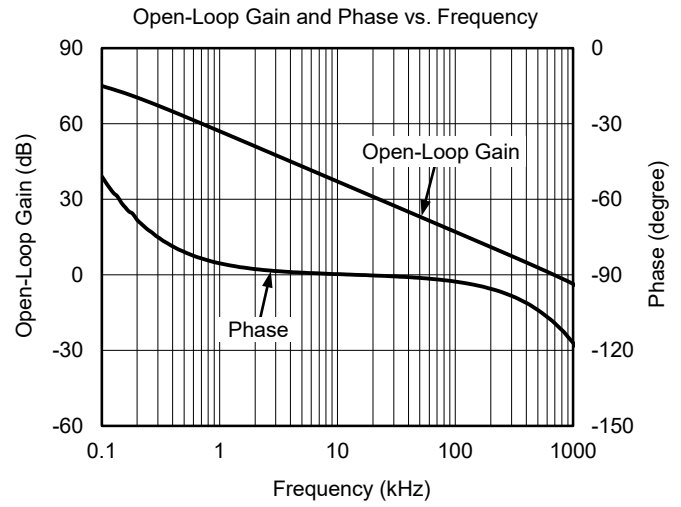
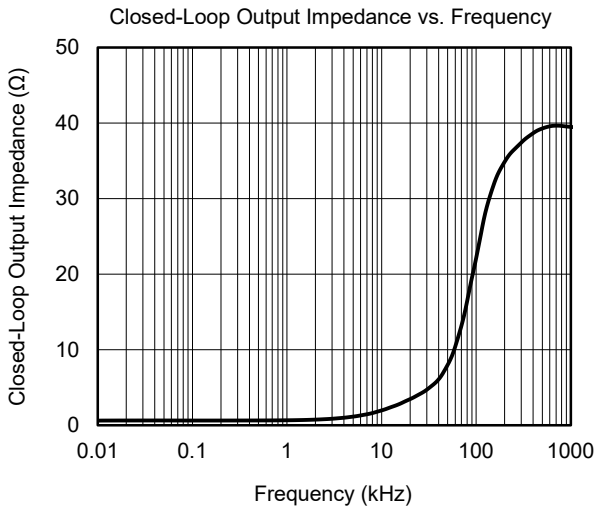

TYPICAL PERFORMANCE CHARACTERISTICS (continued)

At $T_A = +25^\circ\text{C}$, $V_S = \pm 15\text{V}$ and $R_L = 2\text{k}\Omega$, unless otherwise noted.

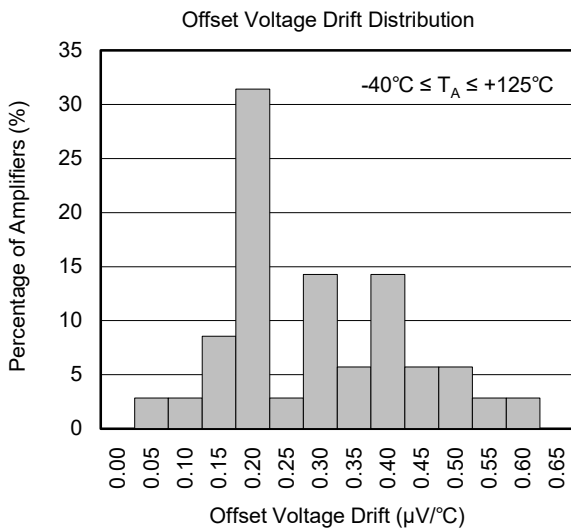
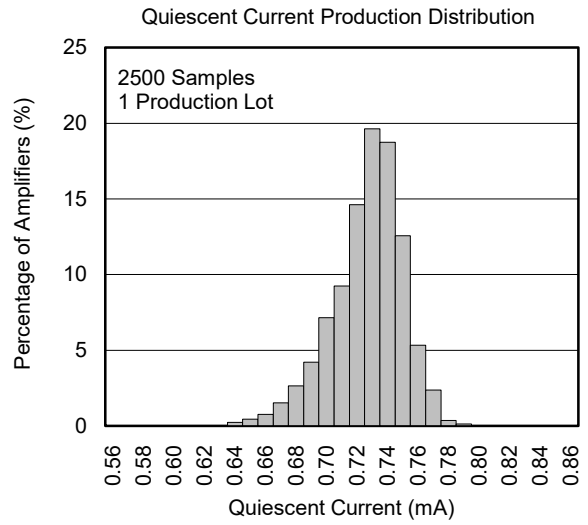
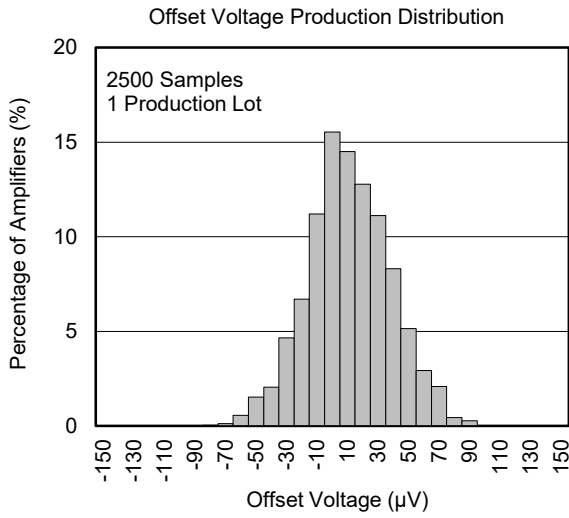

APPLICATION INFORMATION

Power Supply Decoupling and Layout

A clean and low noise power supply is very important in amplifier circuit design, besides of input signal noise, the power supply is one of important source of noise to the amplifier through +V_S and -V_S pins. Power supply bypassing is an effective method to clear up the noise at power supply, and the low impedance path to ground of decoupling capacitor will bypass the noise to GND. In application, 10μF ceramic capacitor paralleled with 0.1μF or 0.01μF ceramic capacitor is used in Figure 1. The ceramic capacitors should be placed as close as possible to +V_S and -V_S power supply pins.

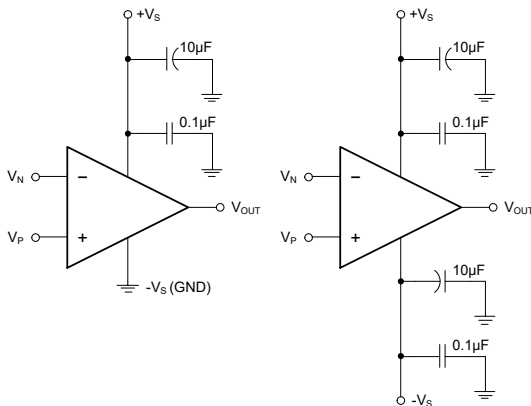

Figure 1. Amplifier Power Supply Bypassing

Grounding

In low speed application, one node grounding technique is the simplest and most effective method to eliminate the noise generated by grounding. In high speed application, the general method to eliminate noise is to use a complete ground plane technique, and the whole ground plane will help distribute heat and reduce EMI noise pickup.

Reduce Input-to-Output Coupling

To reduce the input-to-output coupling, the input traces must be placed as far away from the power supply or output traces as possible. The sensitive trace must not be placed in parallel with the noisy trace in same layer. They must be placed perpendicularly in different layers to reduce the crosstalk. These PCB layout techniques will help to reduce unwanted positive feedback and noise.

Typical Application Circuits

Difference Amplifier

The circuit in Figure 2 is a design example of classical difference amplifier. If $R_4/R_3 = R_2/R_1$, then $V_{OUT} = (V_P - V_N) \times R_2/R_1 + V_{REF}$.

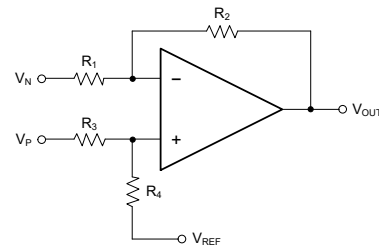

Figure 2. Difference Amplifier

High Input Impedance Difference Amplifier

The circuit in Figure 3 is a design example of high input impedance difference amplifier, the added amplifiers at the input are used to increase the input impedance and eliminate drawback of low input impedance in Figure 2.

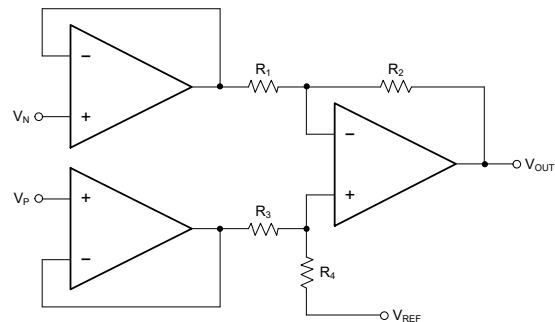

Figure 3. High Input Impedance Difference Amplifier

Active Low-Pass Filter

The circuit in Figure 4 is a design example of active low-pass filter, the DC gain is equal to $-R_2/R_1$ and the -3dB corner frequency is equal to $1/2\pi R_2 C$. In this design, the filter bandwidth must be less than the bandwidth of the amplifier, the resistor values must be selected as low as possible to reduce ringing or oscillation generated by the parasitic parameters in PCB layout.

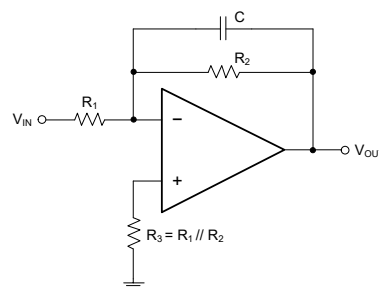

Figure 4. Active Low-Pass Filter

REVISION HISTORY

NOTE: Page numbers for previous revisions may differ from page numbers in the current version.

Changes from Original (MAY 2021) to REV.B

Page

Changed from product preview to production data.....	All
--	-----

PACKAGE INFORMATION

PACKAGE OUTLINE DIMENSIONS

SOT-23-5

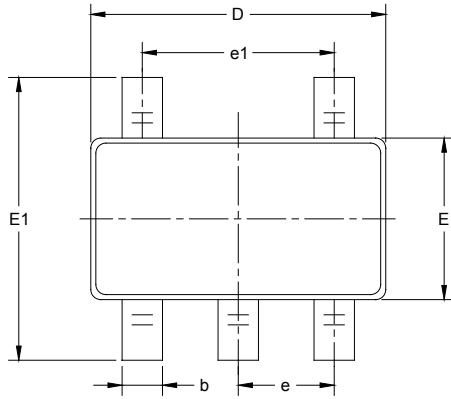

RECOMMENDED LAND PATTERN (Unit: mm)

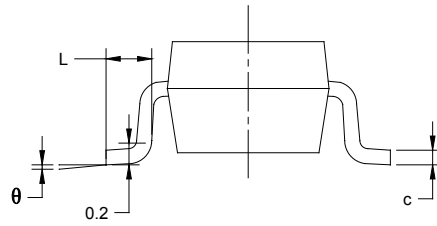
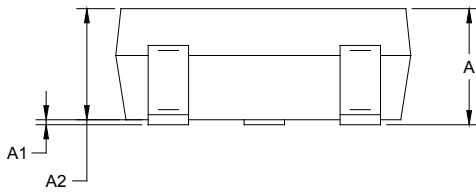

Symbol	Dimensions In Millimeters		Dimensions In Inches	
	MIN	MAX	MIN	MAX
A	1.050	1.250	0.041	0.049
A1	0.000	0.100	0.000	0.004
A2	1.050	1.150	0.041	0.045
b	0.300	0.500	0.012	0.020
c	0.100	0.200	0.004	0.008
D	2.820	3.020	0.111	0.119
E	1.500	1.700	0.059	0.067
E1	2.650	2.950	0.104	0.116
e	0.950 BSC		0.037 BSC	
e1	1.900 BSC		0.075 BSC	
L	0.300	0.600	0.012	0.024
θ	0°	8°	0°	8°

PACKAGE OUTLINE DIMENSIONS

SOIC-8

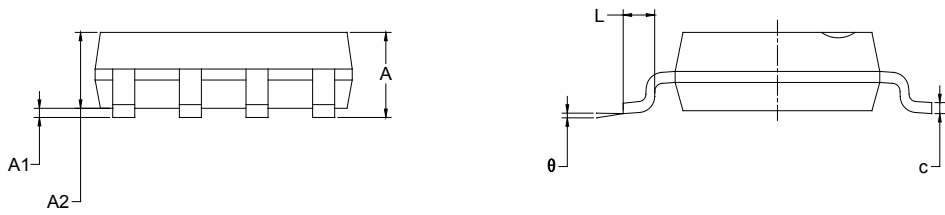
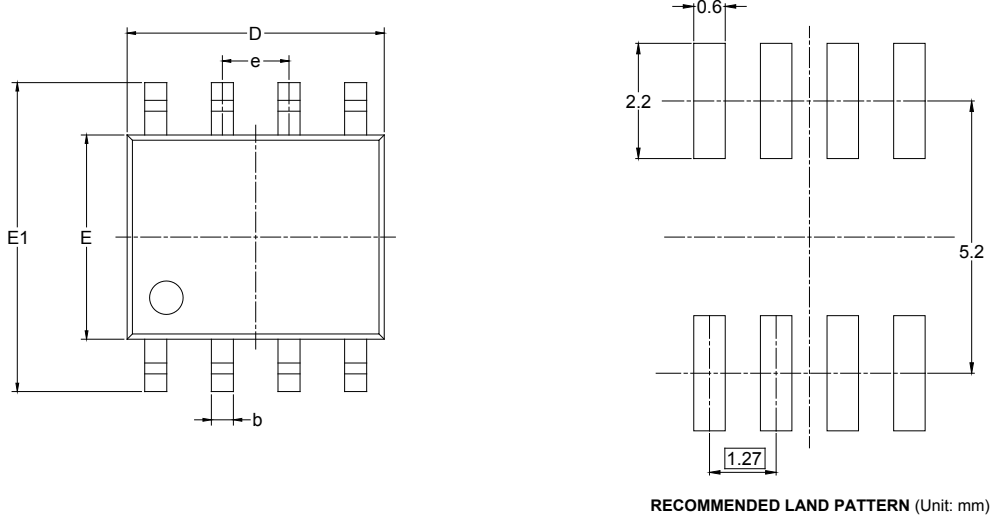

Symbol	Dimensions In Millimeters		Dimensions In Inches	
	MIN	MAX	MIN	MAX
A	1.350	1.750	0.053	0.069
A1	0.100	0.250	0.004	0.010
A2	1.350	1.550	0.053	0.061
b	0.330	0.510	0.013	0.020
c	0.170	0.250	0.006	0.010
D	4.700	5.100	0.185	0.200
E	3.800	4.000	0.150	0.157
E1	5.800	6.200	0.228	0.244
e	1.27 BSC		0.050 BSC	
L	0.400	1.270	0.016	0.050
θ	0°	8°	0°	8°

TAPE AND REEL INFORMATION

REEL DIMENSIONS



TAPE DIMENSIONS



NOTE: The picture is only for reference. Please make the object as the standard.

KEY PARAMETER LIST OF TAPE AND REEL

Package Type	Reel Diameter	Reel Width W1 (mm)	A0 (mm)	B0 (mm)	K0 (mm)	P0 (mm)	P1 (mm)	P2 (mm)	W (mm)	Pin1 Quadrant
SOT-23-5	7"	9.5	3.20	3.20	1.40	4.0	4.0	2.0	8.0	Q3
SOIC-8	13"	12.4	6.40	5.40	2.10	4.0	8.0	2.0	12.0	Q1

D00001

PACKAGE INFORMATION

CARTON BOX DIMENSIONS



NOTE: The picture is only for reference. Please make the object as the standard.

KEY PARAMETER LIST OF CARTON BOX

Reel Type	Length (mm)	Width (mm)	Height (mm)	Pizza/Carton
7" (Option)	368	227	224	8
7"	442	410	224	18
13"	386	280	370	5

DD0002