

## GENERAL DESCRIPTION

The SGM61014 and SGM61014D are high efficiency and miniature size synchronous Buck converters with an input voltage range of 2.3V to 5.5V, optimized for low input voltage applications. This 5.8MHz high frequency device does not need external compensation and is a perfect solution for compact designs. Output voltage is fixed internally and output voltage resistor divider is no longer required. Only 470nH inductor and 10μF capacitor are needed as output filter. With its adaptive hysteresis and pseudo-constant on-time control (AHP-COT) architecture, the load transient performance is excellent and the output voltage regulation accuracy is achieved.

The device provides pulse-width modulation (PWM) and pulse frequency modulation (PFM) selection by pulling the MODE pin high and low. If the MODE pin is high, it operates in PWM mode over the whole load range. The peak efficiency is up to 92% in PWM mode. If the MODE pin is low, it works in PWM mode at heavy loads and automatically enters PFM at light loads to maintain its high efficiency, and for further efficiency improvement, it enters power-save mode (PSM) at lighter load. The typical quiescent current is 22μA at PSM mode and the efficiency of 5mA load current is maintained over 80%.

The device is available in a Green WLCSP-0.86×1.16-6B package.

## TYPICAL APPLICATION

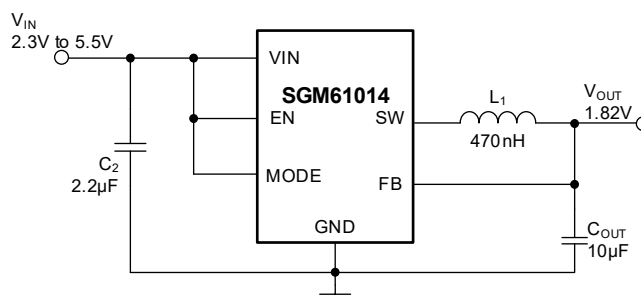

Figure 1. Typical Application Circuit

## FEATURES

- 2.3V to 5.5V Input Voltage Range
- Output Current Capability: 1A
- 22μA Typical Quiescent Current
- 5.8MHz Fixed-Frequency Operation
- Best-in-Class Load Transient Response
- Best-in-Class Efficiency
- Low Ripple Light-Load PFM and PSM Mode
- Forced PWM and PFM Mode Selectable
- Internal Soft-Start
- Input Under-Voltage Lockout (UVLO)
- Thermal Shutdown and Overload Protection
- Optional Output Discharge: SGM61014D Only
- Available in a Green WLCSP-0.86×1.16-6B Package

## APPLICATIONS

4G, 5G Data Cards  
 Tablets  
 DSC, DVC  
 Smart Watches  
 Notebooks

**PACKAGE/ORDERING INFORMATION**

MODEL	PACKAGE DESCRIPTION	SPECIFIED TEMPERATURE RANGE	ORDERING NUMBER	PACKAGE MARKING	PACKING OPTION
SGM61014D-2.05	WLCSP-0.86×1.16-6B	-40°C to +125°C	SGM61014D-2.05XG/TR	XXX 023	Tape and Reel, 3000
SGM61014D-1.82	WLCSP-0.86×1.16-6B	-40°C to +125°C	SGM61014D-1.82XG/TR	XXX 04K	Tape and Reel, 3000
SGM61014D-1.35	WLCSP-0.86×1.16-6B	-40°C to +125°C	SGM61014D-1.35XG/TR	XXX 0AU	Tape and Reel, 3000
SGM61014D-1.23	WLCSP-0.86×1.16-6B	-40°C to +125°C	SGM61014D-1.23XG/TR	XXX 0AV	Tape and Reel, 3000
SGM61014D-1.20	WLCSP-0.86×1.16-6B	-40°C to +125°C	SGM61014D-1.20XG/TR	XXX 0AW	Tape and Reel, 3000
SGM61014D-1.15	WLCSP-0.86×1.16-6B	-40°C to +125°C	SGM61014D-1.15XG/TR	XXX 0AX	Tape and Reel, 3000
SGM61014D-1.10	WLCSP-0.86×1.16-6B	-40°C to +125°C	SGM61014D-1.10XG/TR	XXX 0AY	Tape and Reel, 3000
SGM61014D-1.00	WLCSP-0.86×1.16-6B	-40°C to +125°C	SGM61014D-1.00XG/TR	XXX 0AZ	Tape and Reel, 3000
SGM61014-2.05	WLCSP-0.86×1.16-6B	-40°C to +125°C	SGM61014-2.05XG/TR	XXX 0JA	Tape and Reel, 3000
SGM61014-1.82	WLCSP-0.86×1.16-6B	-40°C to +125°C	SGM61014-1.82XG/TR	XXX 0JB	Tape and Reel, 3000
SGM61014-1.35	WLCSP-0.86×1.16-6B	-40°C to +125°C	SGM61014-1.35XG/TR	XXX 0JC	Tape and Reel, 3000
SGM61014-1.23	WLCSP-0.86×1.16-6B	-40°C to +125°C	SGM61014-1.23XG/TR	XXX 0JD	Tape and Reel, 3000
SGM61014-1.20	WLCSP-0.86×1.16-6B	-40°C to +125°C	SGM61014-1.20XG/TR	XXX 0JE	Tape and Reel, 3000
SGM61014-1.15	WLCSP-0.86×1.16-6B	-40°C to +125°C	SGM61014-1.15XG/TR	XXX 0JF	Tape and Reel, 3000
SGM61014-1.10	WLCSP-0.86×1.16-6B	-40°C to +125°C	SGM61014-1.10XG/TR	XXX 0JG	Tape and Reel, 3000
SGM61014-1.00	WLCSP-0.86×1.16-6B	-40°C to +125°C	SGM61014-1.00XG/TR	XXX 0JH	Tape and Reel, 3000

**MARKING INFORMATION**

NOTE: XXX = Date Code and Trace Code.

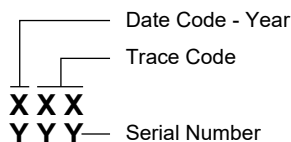

Green (RoHS & HSF): SG Micro Corp defines "Green" to mean Pb-Free (RoHS compatible) and free of halogen substances. If you have additional comments or questions, please contact your SGMICRO representative directly.

**ABSOLUTE MAXIMUM RATINGS**

VIN Voltage.....	-0.3V to 6V
SW, EN, FB and MODE Voltages.....	-0.3V to VIN + 0.3V
Package Thermal Resistance	
WLCSP-0.86×1.16-6B, θJA .....	113°C/W
Junction Temperature.....	+150°C
Storage Temperature Range .....	-65°C to +150°C
Lead Temperature (Soldering, 10s).....	+260°C
ESD Susceptibility	
HBM.....	4000V
CDM .....	1000V

**RECOMMENDED OPERATING CONDITIONS**

Input Voltage Range, VIN .....	2.3V to 5.5V
Output Voltage Current, IOUT.....	0A to 1A
Inductor, L.....	470nH
Input Capacitor, CIN .....	2.2µF
Output Capacitor, COUT .....	10µF
Operating Junction Temperature .....	-40°C to +125°C

**OVERSTRESS CAUTION**

Stresses beyond those listed in Absolute Maximum Ratings may cause permanent damage to the device. Exposure to absolute maximum rating conditions for extended periods may affect reliability. Functional operation of the device at any conditions beyond those indicated in the Recommended Operating Conditions section is not implied.

**ESD SENSITIVITY CAUTION**

This integrated circuit can be damaged if ESD protections are not considered carefully. SGMICRO recommends that all integrated circuits be handled with appropriate precautions. Failure to observe proper handling and installation procedures can cause damage. ESD damage can range from subtle performance degradation to complete device failure. Precision integrated circuits may be more susceptible to damage because even small parametric changes could cause the device not to meet the published specifications.

**DISCLAIMER**

SG Micro Corp reserves the right to make any change in circuit design, or specifications without prior notice.

## PIN CONFIGURATION

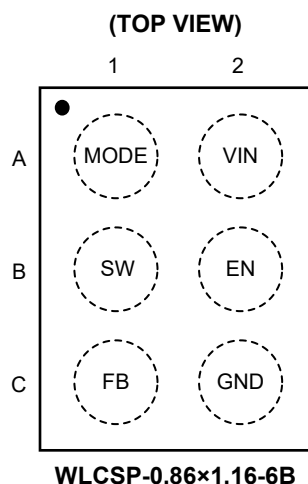

## PIN DESCRIPTION

PIN	NAME	FUNCTION
A1	MODE	Input for Working Mode Setting. Do not leave this pin floating. MODE = Logic High: The chip always operates in PWM mode. MODE = Logic Low: The chip switches to pulse frequency modulation (PFM) automatically at light loads.
A2	VIN	Power Supply Voltage Input.
B1	SW	Switch Node of the Power Converter. Connect it to the output inductor.
B2	EN	Enable Pin. Logic high sets the device active, logic low disables it and turns it into shutdown mode. Do not leave this pin floating.
C1	FB	Direct Output Voltage Feedback. Must be connected to output voltage.
C2	GND	Power and Signal Ground.

**ELECTRICAL CHARACTERISTICS**(V<sub>IN</sub> = V<sub>EN</sub> = 2.3V to 5.5V, T<sub>J</sub> = -40°C to +125°C, typical values are at T<sub>J</sub> = +25°C and V<sub>IN</sub> = V<sub>EN</sub> = 3.6V, unless otherwise noted.)

PARAMETER	SYMBOL	CONDITIONS	MIN	TYP	MAX	UNITS		
<b>Power Supplies</b>								
Input Voltage Range	V <sub>IN</sub>		2.3		5.5	V		
Quiescent Current	I <sub>Q</sub>	No load, not switching		22	31	μA		
		PWM mode		8.1		mA		
Shutdown Supply Current	I <sub>SD</sub>	EN = GND		0.01	0.5	μA		
Under-Voltage Lockout Threshold	V <sub>UVLO</sub>	Rising V <sub>IN</sub>		2.15	2.25	V		
Under-Voltage Lockout Hysteresis	V <sub>UVHYS</sub>			200		mV		
<b>Logic Inputs: EN and MODE Pins</b>								
Enable High-Level Input Voltage	V <sub>IH</sub>	V <sub>IN</sub> = 2.3V to 5.5V	1.2			V		
Enable Low-Level Input Voltage	V <sub>IL</sub>	V <sub>IN</sub> = 2.3V to 5.5V			0.5	V		
Logic Input Hysteresis Voltage	V <sub>LHYS</sub>			80		mV		
Enable Input Leakage Current	I <sub>IN</sub>	Pin to V <sub>IN</sub> or GND		0.01	0.5	μA		
<b>Switching and Synchronization</b>								
Switching Frequency	f <sub>SW</sub>	V <sub>IN</sub> = 3.6V, V <sub>OUT</sub> = 1.82V, T <sub>A</sub> = +25°C, PWM mode		5.8		MHz		
<b>Regulation</b>								
Output Voltage Accuracy	V <sub>OUT</sub>	1.000V	I <sub>LOAD</sub> = 0A to 1A		1		V	
			PWM mode, V <sub>IN</sub> = 3.6V	0.984	1	1.016		
		1.100V	I <sub>LOAD</sub> = 0A to 1A		1.1			
			PWM mode, V <sub>IN</sub> = 3.6V	1.082	1.1	1.118		
		1.150V	I <sub>LOAD</sub> = 0A to 1A		1.15			
			PWM mode, V <sub>IN</sub> = 3.6V	1.132	1.15	1.168		
		1.200V	I <sub>LOAD</sub> = 0A to 1A		1.2			
			PWM mode, V <sub>IN</sub> = 3.6V	1.181	1.2	1.219		
		1.233V	I <sub>LOAD</sub> = 0A to 1A		1.233			
			PWM mode, V <sub>IN</sub> = 3.6V	1.213	1.233	1.253		
		1.350V	I <sub>LOAD</sub> = 0A to 1A		1.35			
			PWM mode, V <sub>IN</sub> = 3.6V	1.328	1.35	1.372		
		1.820V	I <sub>LOAD</sub> = 0A to 1A		1.82			
			PWM mode, V <sub>IN</sub> = 3.6V	1.791	1.82	1.849		
		2.050V	I <sub>LOAD</sub> = 0A to 1A		2.05			
			PWM mode, V <sub>IN</sub> = 3.6V	2.017	2.05	2.083		
Soft-Start	t <sub>SS</sub>	V <sub>IN</sub> = 3.6V, V <sub>OUT</sub> = 1.82V, T <sub>A</sub> = +25°C, Measure from First pulse to 90% × V <sub>OUT</sub> (set)		260		μs		
<b>Output Driver</b>								
PMOS On-Resistance	R <sub>DSON</sub>	V <sub>GS</sub> = 3.6V		165		mΩ		
NMOS On-Resistance		V <sub>GS</sub> = 3.6V		100		mΩ		
PMOS Peak Current Limit	I <sub>LIM_OL</sub>	Open-loop for SGM61014, V <sub>IN</sub> = 3.6V, T <sub>A</sub> = +25°C	1550	2100	2600	mA		
Output Discharge Resistance	R <sub>DIS</sub>	EN = GND, SGM61014D only		240		Ω		
Thermal Shutdown	T <sub>TSD</sub>			150		°C		
Thermal Shutdown Hysteresis	T <sub>HYS</sub>			15		°C		

TYPICAL PERFORMANCE CHARACTERISTICS

T<sub>A</sub> = +25°C, V<sub>IN</sub> = V<sub>EN</sub> = 3.6V, V<sub>OUT</sub> = 1.82V, L<sub>1</sub> = 470nH, and C<sub>OUT</sub> = 10µF, unless otherwise noted.

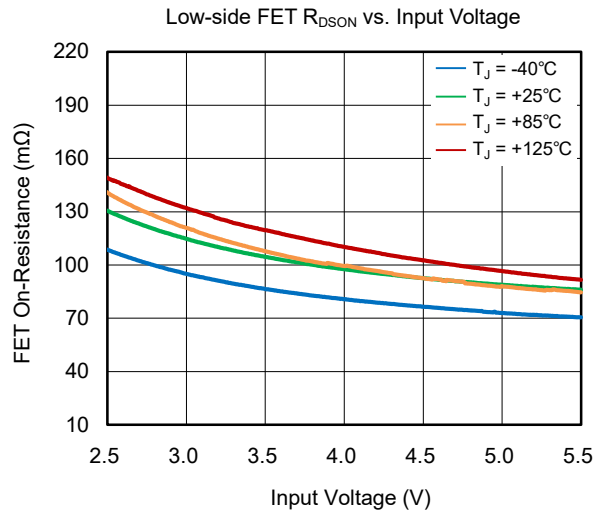
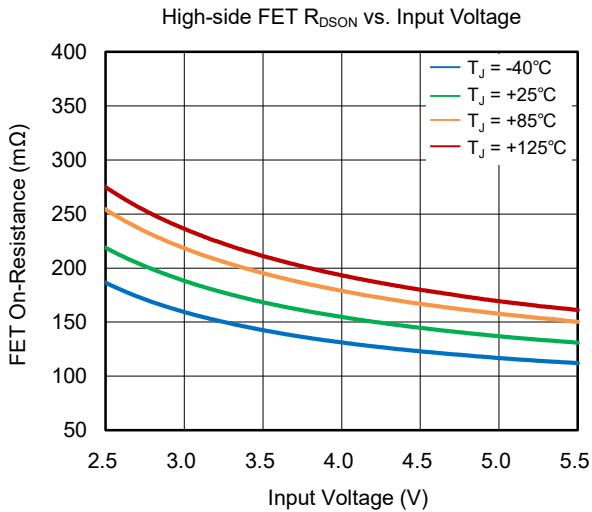
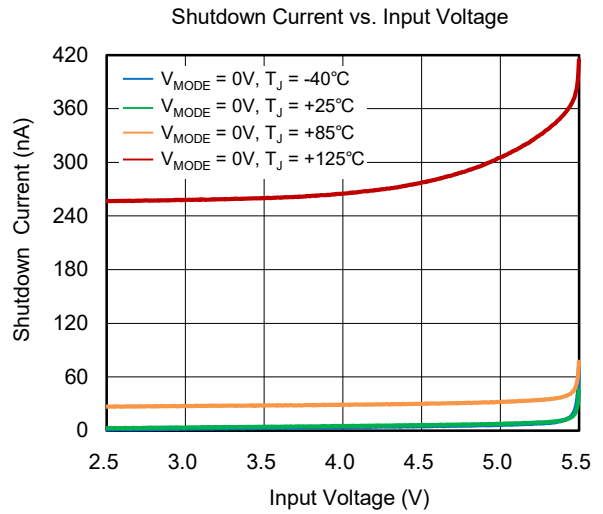
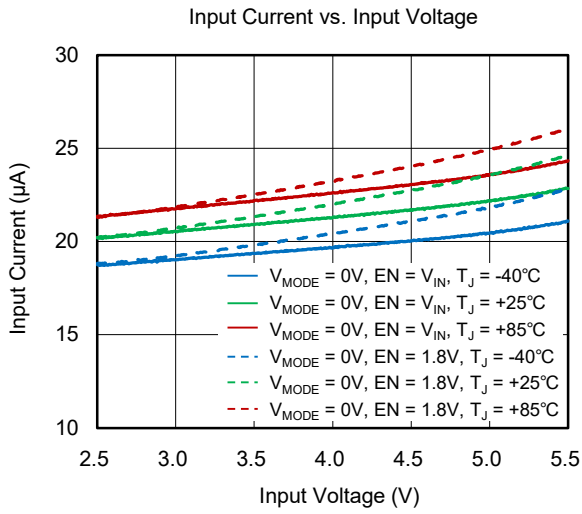

TYPICAL PERFORMANCE CHARACTERISTICS (continued)

T<sub>A</sub> = +25°C, V<sub>IN</sub> = V<sub>EN</sub> = 3.6V, V<sub>OUT</sub> = 1.82V, L<sub>1</sub> = 470nH, DCR = 44mΩ and C<sub>OUT</sub> = 10μF, unless otherwise noted.

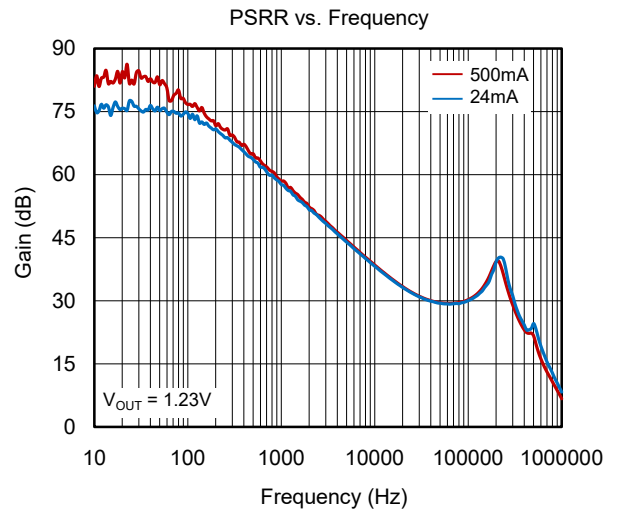
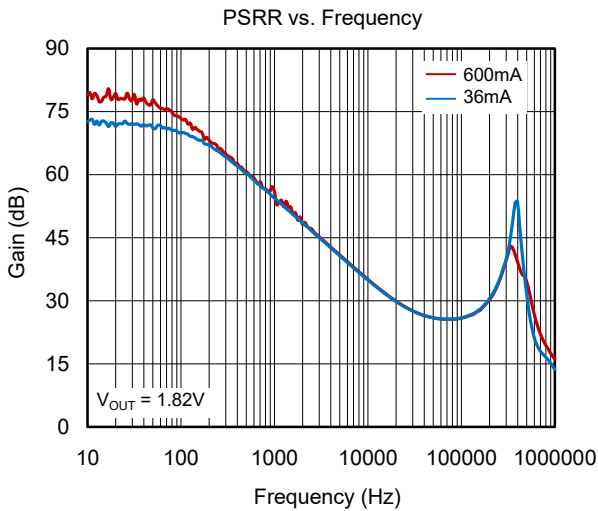
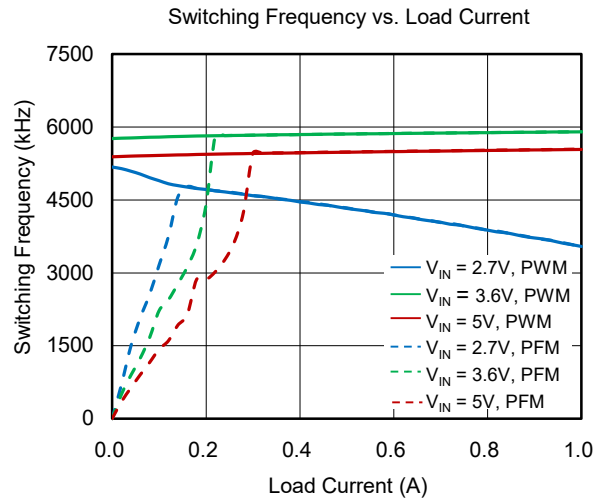
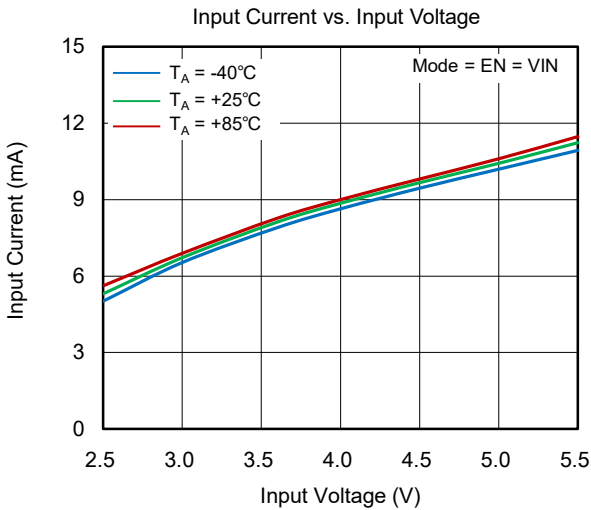
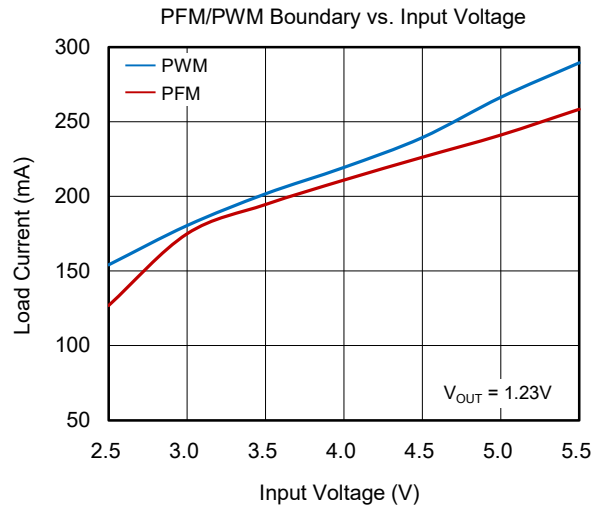
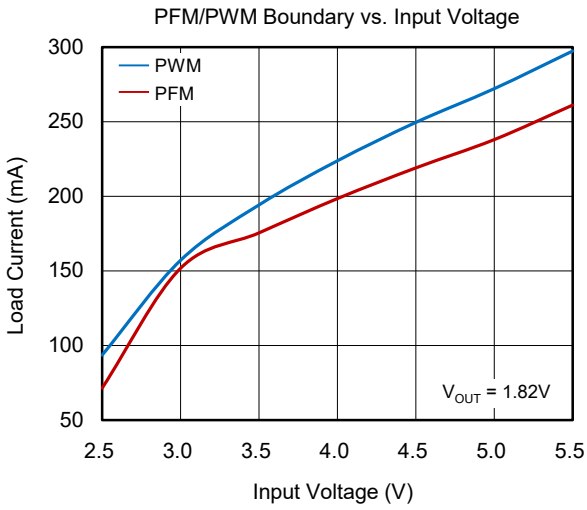

TYPICAL PERFORMANCE CHARACTERISTICS (continued)

T<sub>A</sub> = +25°C, V<sub>IN</sub> = V<sub>EN</sub> = 3.6V, V<sub>OUT</sub> = 1.82V, L<sub>1</sub> = 470nH, DCR = 44mΩ and C<sub>OUT</sub> = 10μF, unless otherwise noted.

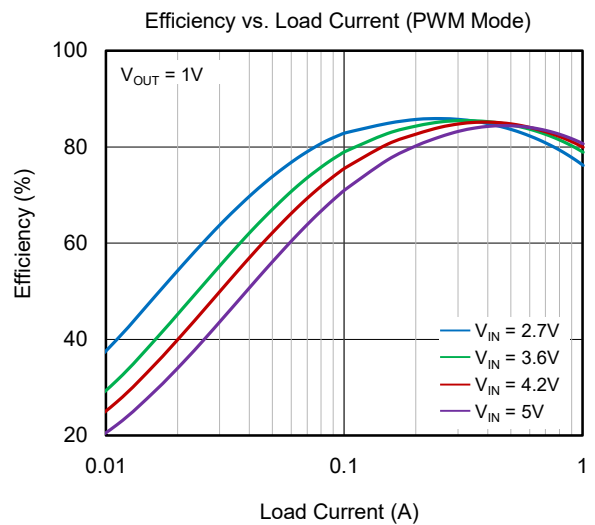
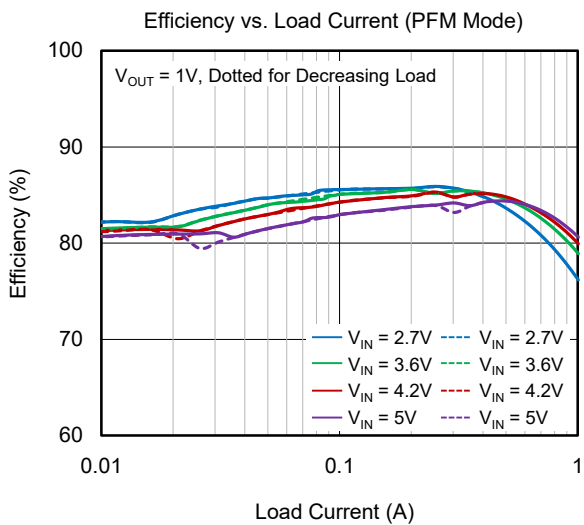
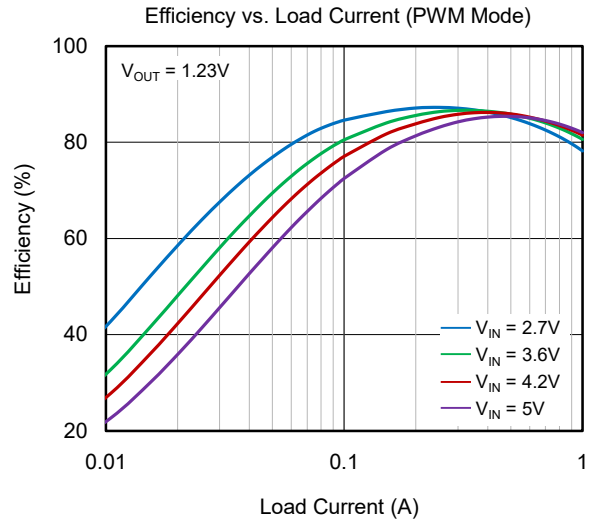
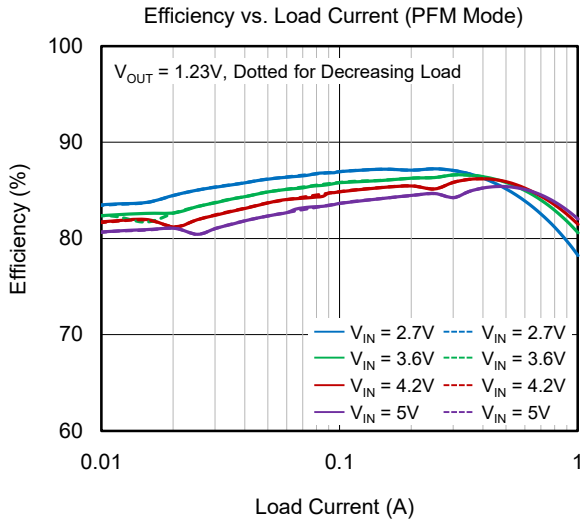
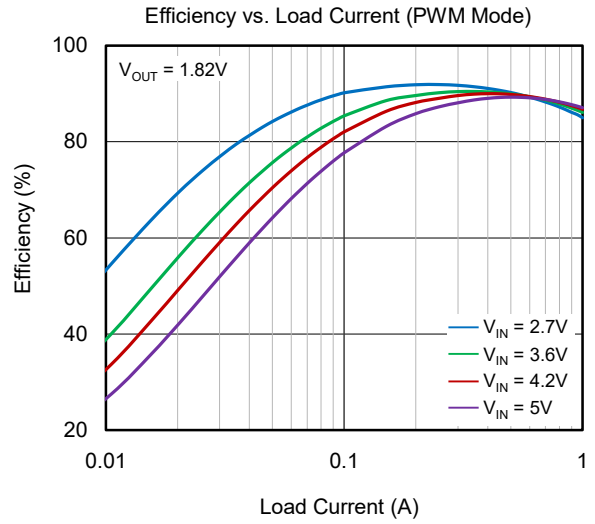
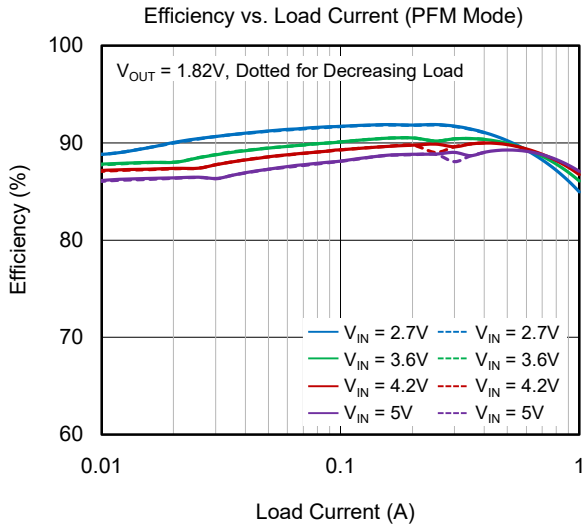



TYPICAL PERFORMANCE CHARACTERISTICS (continued)

T<sub>A</sub> = +25°C, V<sub>IN</sub> = V<sub>EN</sub> = 3.6V, V<sub>OUT</sub> = 1.82V, L<sub>1</sub> = 470nH, DCR = 44mΩ and C<sub>OUT</sub> = 10μF, unless otherwise noted.

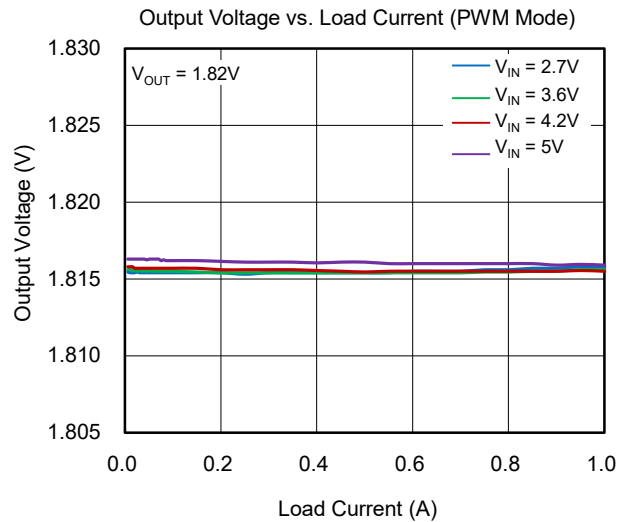
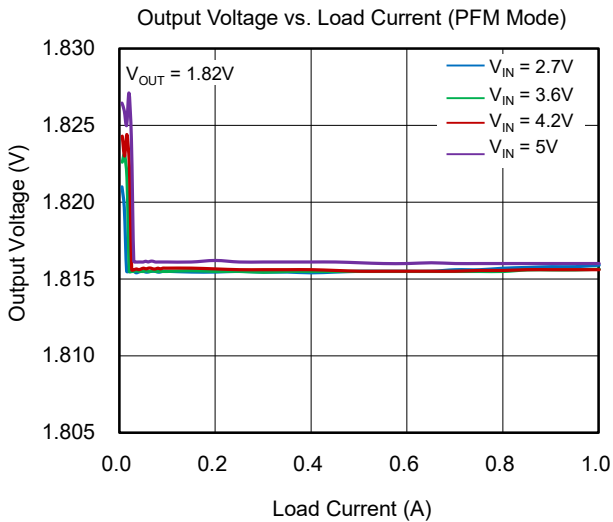
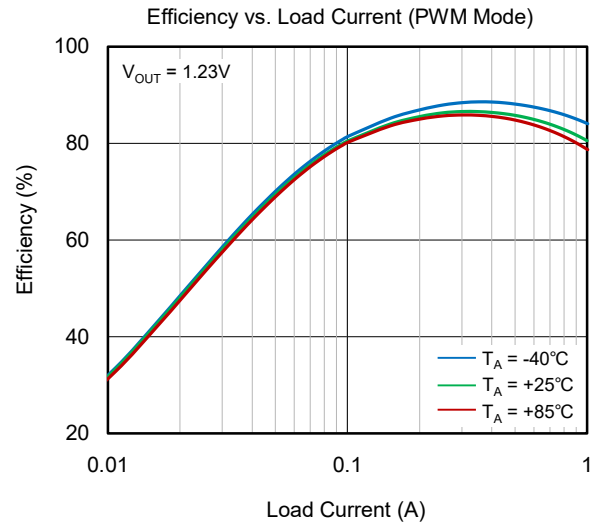
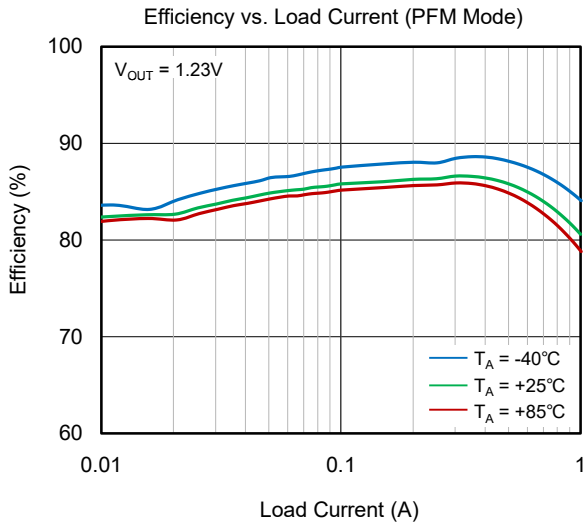
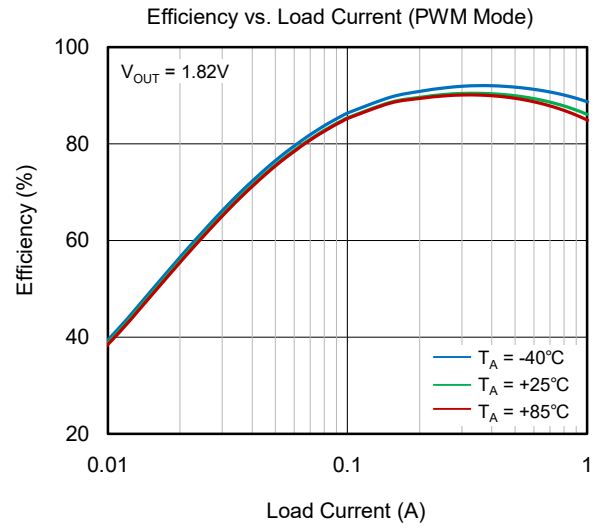
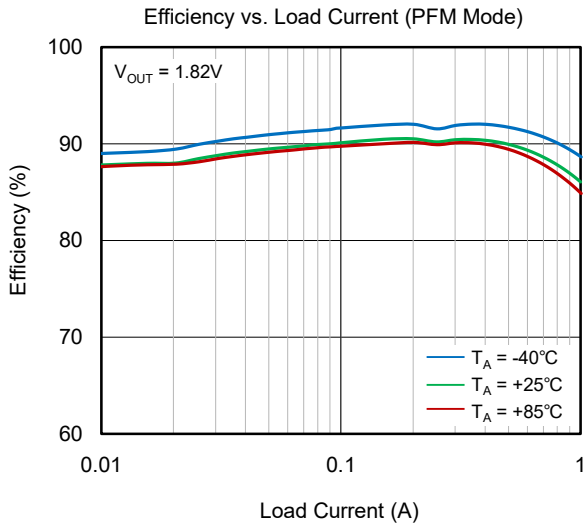

TYPICAL PERFORMANCE CHARACTERISTICS (continued)

T<sub>A</sub> = +25°C, V<sub>IN</sub> = V<sub>EN</sub> = 3.6V, V<sub>OUT</sub> = 1.82V, L<sub>1</sub> = 470nH, DCR = 44mΩ and C<sub>OUT</sub> = 10μF, unless otherwise noted.

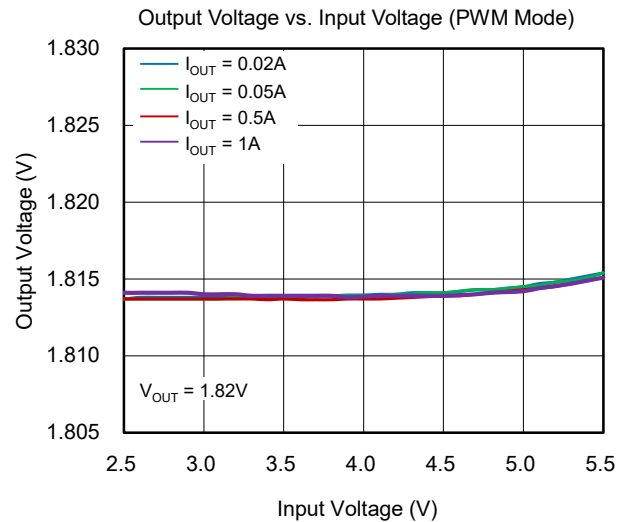
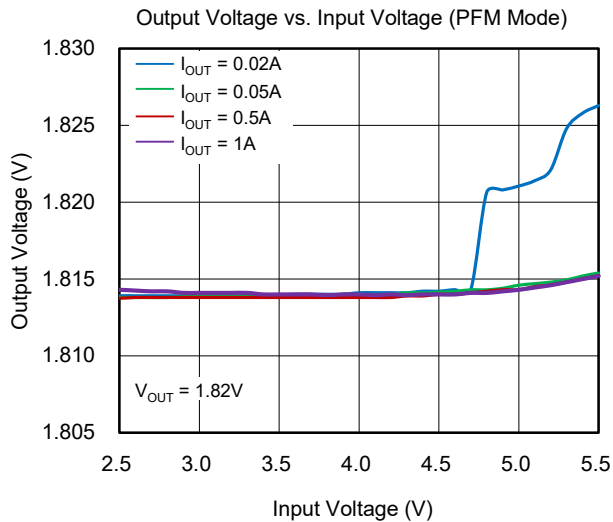
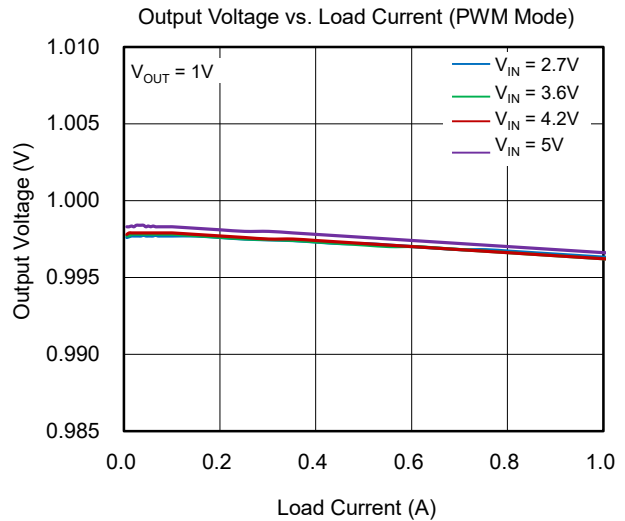
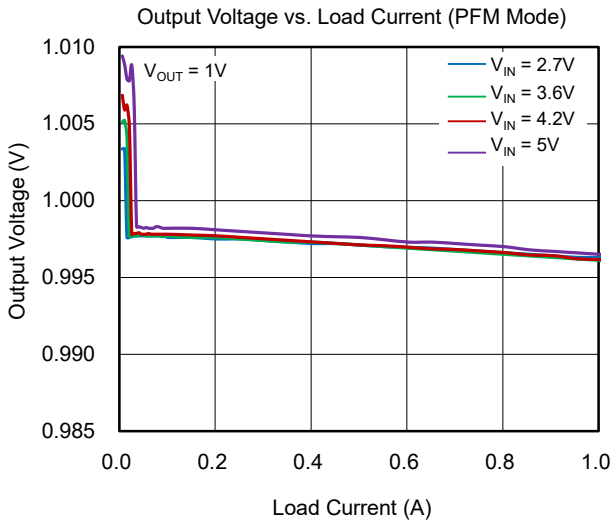
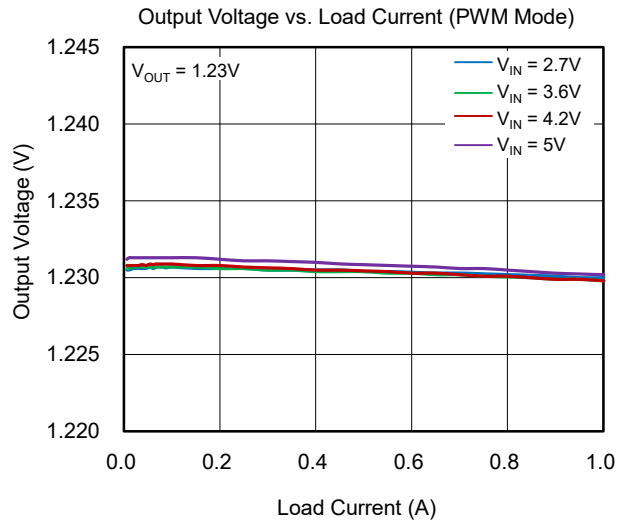
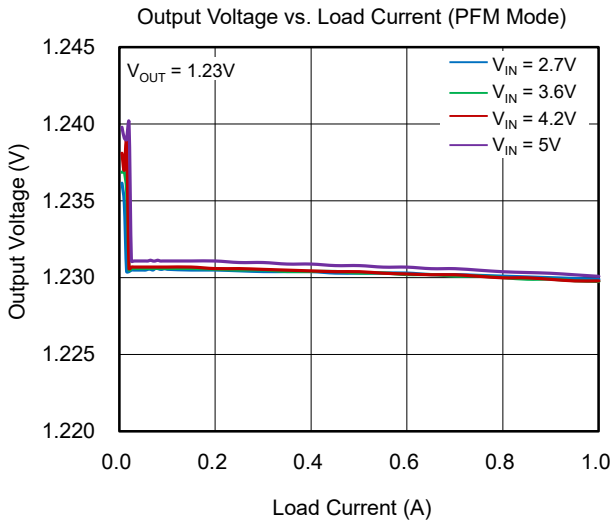

TYPICAL PERFORMANCE CHARACTERISTICS (continued)

T<sub>A</sub> = +25°C, V<sub>IN</sub> = V<sub>EN</sub> = 3.6V, V<sub>OUT</sub> = 1.82V, L<sub>1</sub> = 470nH, DCR = 44mΩ and C<sub>OUT</sub> = 10μF, unless otherwise noted.

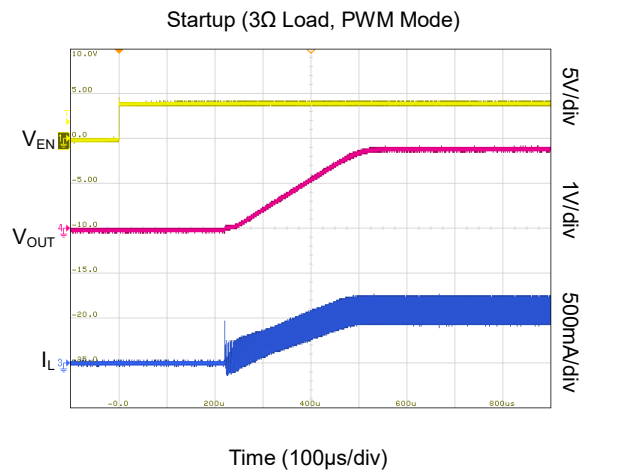
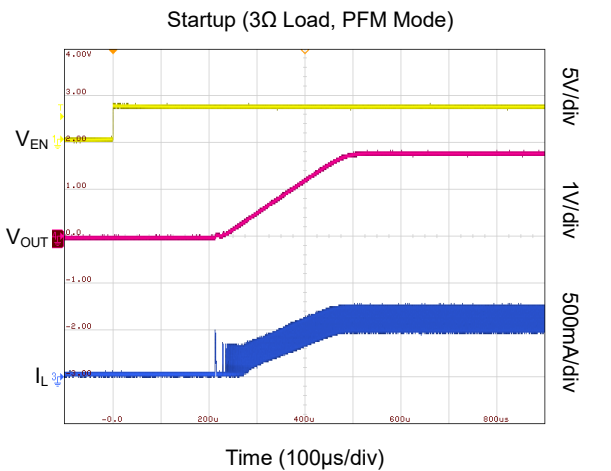
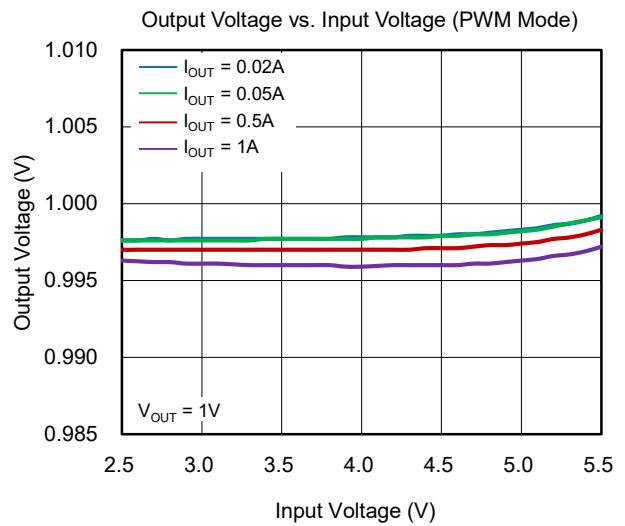
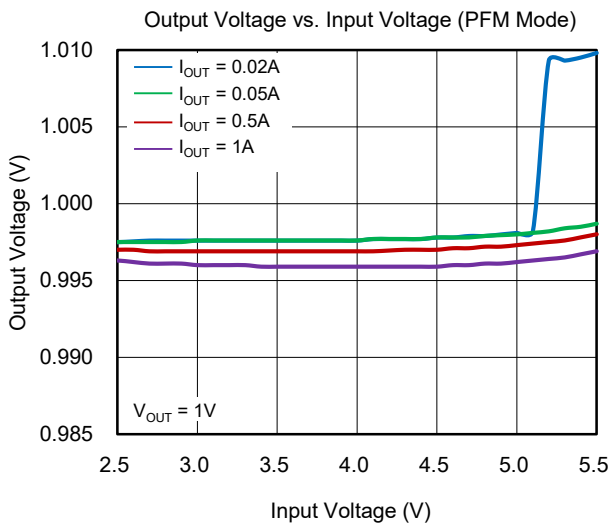
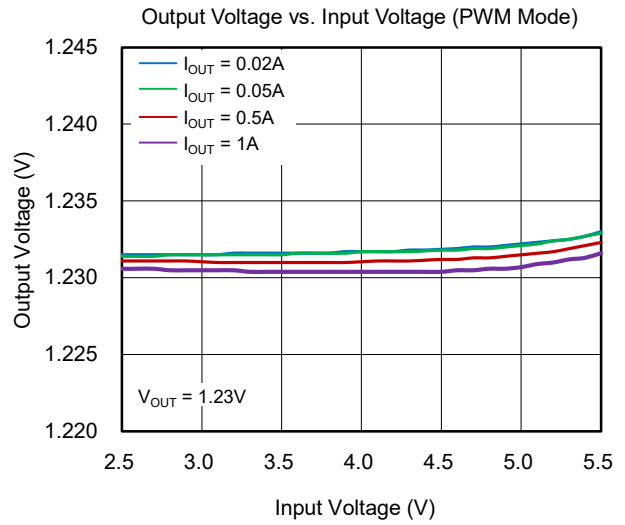
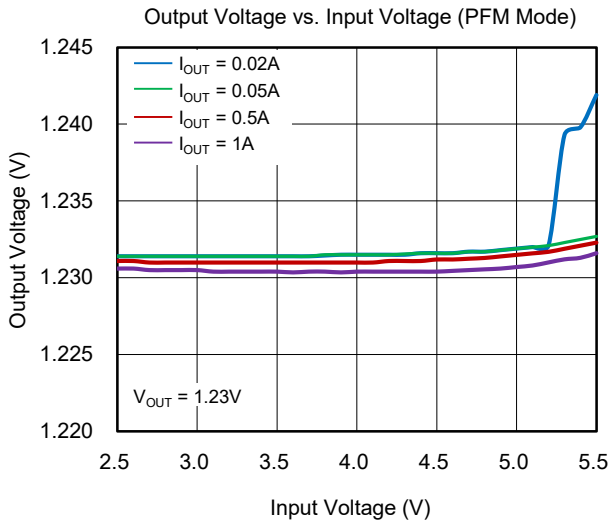

TYPICAL PERFORMANCE CHARACTERISTICS (continued)

T<sub>A</sub> = +25°C, V<sub>IN</sub> = V<sub>EN</sub> = 3.6V, V<sub>OUT</sub> = 1.82V, L<sub>1</sub> = 470nH, and C<sub>OUT</sub> = 10µF, unless otherwise noted.

Startup (50Ω Load, PFM Mode)

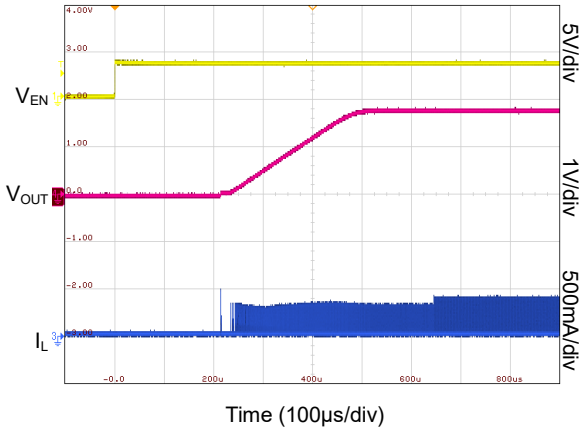

Startup (50Ω Load, PWM Mode)

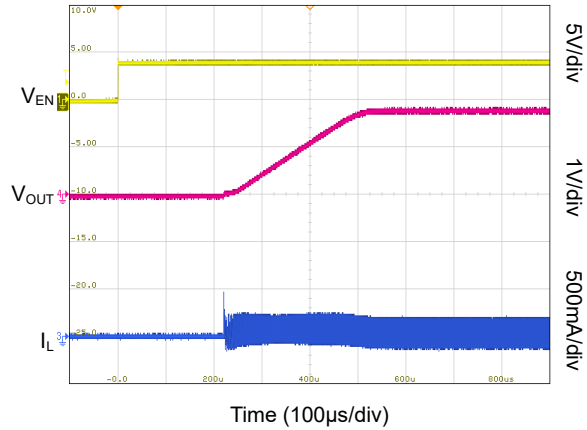

Shutdown (No Load, PFM Mode)

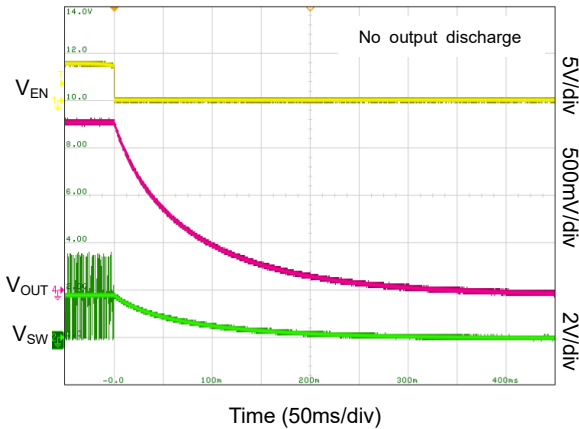

Shutdown (No Load, PWM Mode)

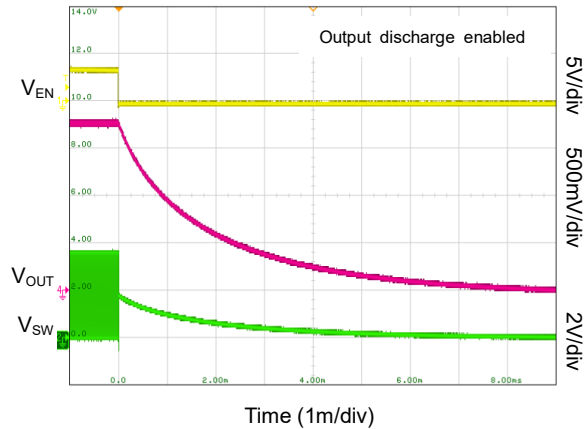

Load Transient (PFM Mode)

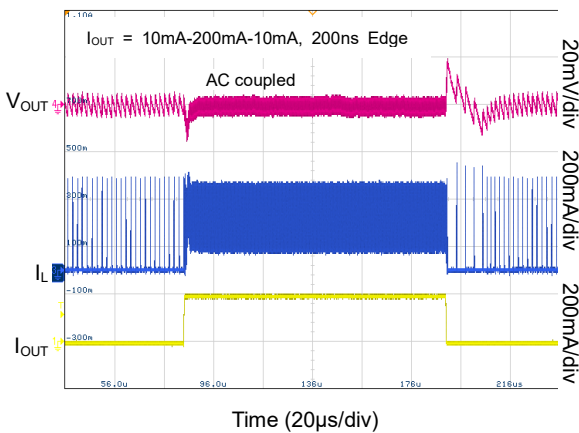

Load Transient (PWM Mode)

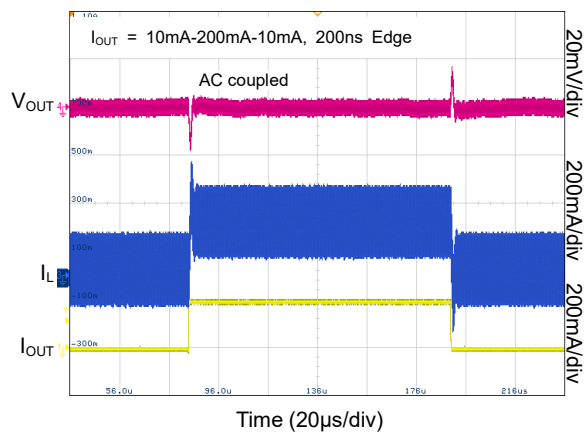

TYPICAL PERFORMANCE CHARACTERISTICS (continued)

T<sub>A</sub> = +25°C, V<sub>IN</sub> = V<sub>EN</sub> = 3.6V, V<sub>OUT</sub> = 1.82V, L<sub>1</sub> = 470nH, and C<sub>OUT</sub> = 10µF, unless otherwise noted.

Load Transient (PFM Mode)

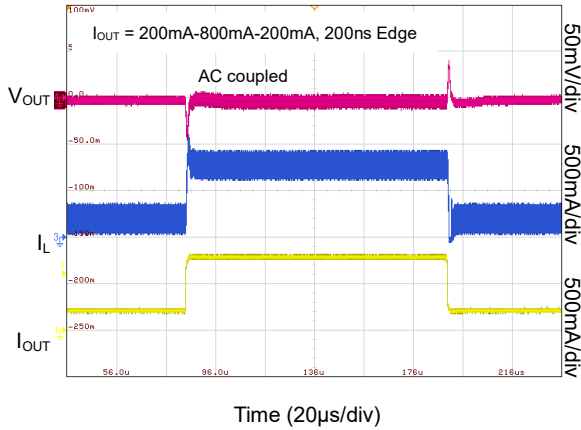

Load Transient (PWM Mode)

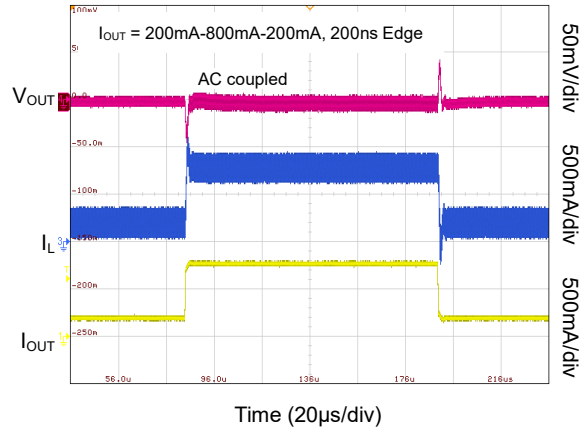

Line Transient (PFM Mode)

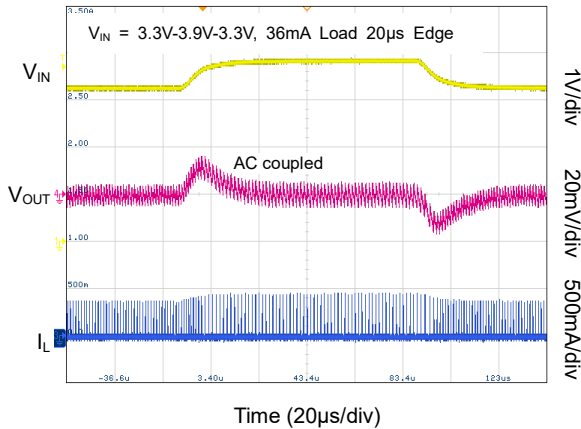

Line Transient (PWM Mode)

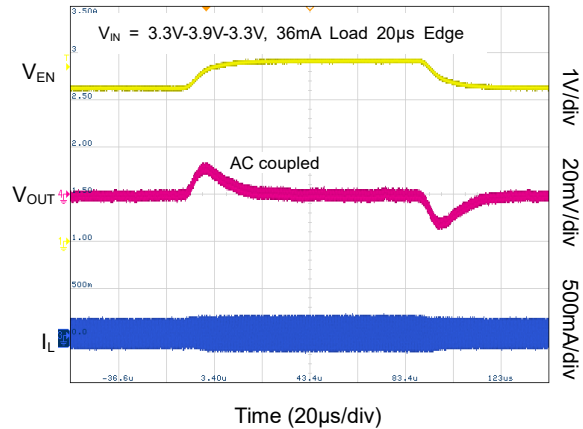

300mΩ Fault, Rapid Fault, Hiccup (PFM Mode)

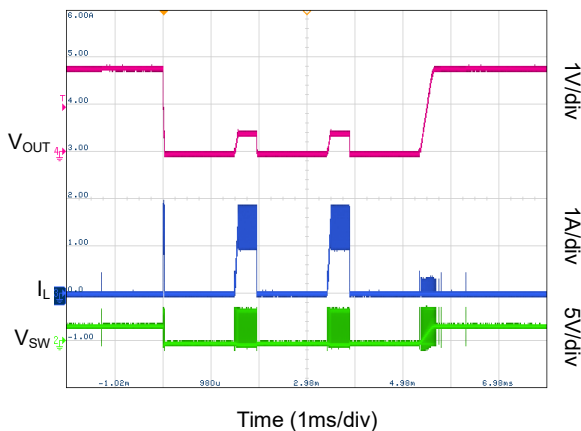

300mΩ Fault, Rapid Fault, Hiccup (PWM Mode)

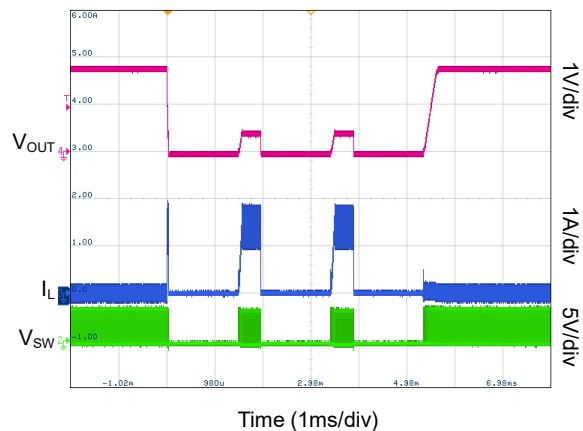

FUNCTIONAL BLOCK DIAGRAM

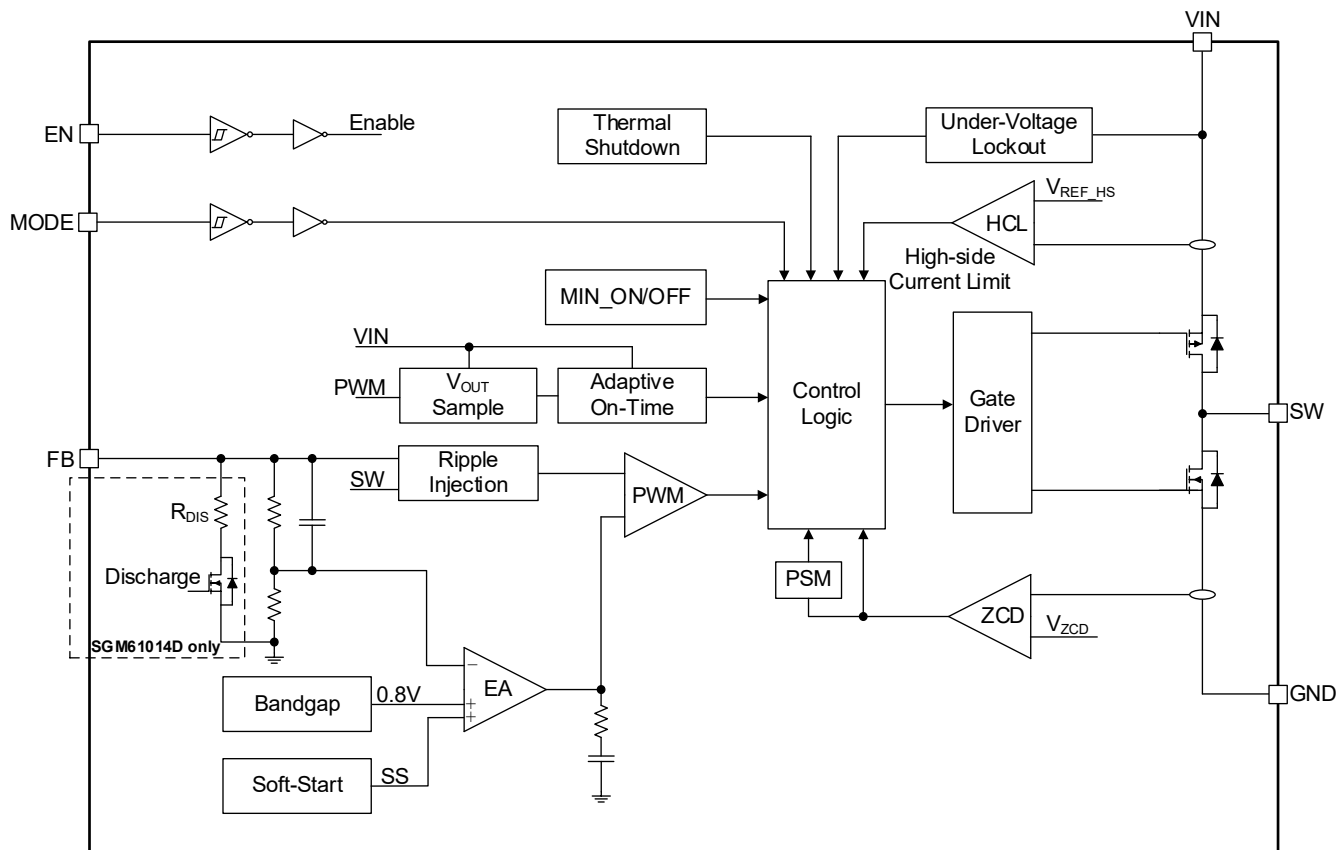

Figure 2. Block Diagram

## DETAILED DESCRIPTION

### Overview

The SGM61014 and SGM61014D are 2.3V to 5.5V input, high efficiency synchronous Buck converters with AHP-COT architecture and advanced regulation topology. A total of 8 fixed output voltages and 1A current ability are available for option.

At medium to heavy loads, the device works in pulse-width modulation (PWM) mode. In PWM mode, the device works with a nominal switching frequency of 5.8MHz. At light loads, the MODE pin is pulled high to force the device to work in PWM, and the mode pin is pulled low to enter PFM. Then, the high efficiency is achieved by reducing switching frequency.

### Under-Voltage Lockout (UVLO)

The device implements the under-voltage lockout (UVLO) with a 200mV (TYP) hysteresis. When the input voltage falls below the  $V_{UVLO}$ , it shuts down the device.

### Enable and Disable

A logic high input to EN activates the device, and a logic low input disables the device. During shutdown mode, the energy consumption falls below 1 $\mu$ A.

### Soft-Start

When EN is set to logic high and after about 260 $\mu$ s delay, the device starts switching and  $V_{OUT}$  increases with 260 $\mu$ s (TYP) internal soft-start circuit.

### 100% Duty Cycle

The device provides low input-to-output voltage drop by going into 100% duty cycle mode. In this mode, the high-side MOSFET is constantly turned on and the low-side MOSFET is turned off. This function can increase the operation time to the utmost extent for battery powered applications. To maintain an appropriate output voltage, the minimum input voltage is calculated by:

$$V_{IN\_MIN} = V_{OUT} + I_{OUT\_MAX} \times (R_{DSON} + R_L) \quad (1)$$

where:

- $V_{IN\_MIN}$  is the minimum input voltage.
- $I_{OUT\_MAX}$  is the maximum output current.
- $R_{DSON}$  is the high-side MOSFET on-resistance.
- $R_L$  is the inductor ohmic resistance.

### Output Discharge

The SGM61014D provide the output discharge function. Whenever the device is disabled by enable, thermal shutdown or under-voltage lockout, the output will be discharged by the FB pin through a typical discharge resistor of  $R_{DIS}$ .

### Inductor Current Limit and Hiccup

If there is an over-current or short-circuit, the device implements an inductor current limit cycle-by-cycle. When the high-side switch current limit is triggered, the high-side MOSFET is turned off and the low-side MOSFET is turned on to reduce the inductor current. If the high-side current limit event lasts for more than 32 cycles, both high-side and low-side are turned off. A new startup is initiated automatically (hiccup) after 1.4ms (TYP). The hiccup repeats until the overload or short-circuit fault is released. The actual current limit value may be larger than the static current limit due to internal propagation delays.

### Power-Save Mode (PSM)

In PFM mode, if the load continues to decrease, the device enters PSM mode, some modules are shut down, and reduce power consumption. When the load increases to a certain value, the closed module is enabled and exits the PSM mode. The power-save mode can reduce the system loss and further improve the efficiency under light load.

### Thermal Shutdown

To protect the device from overheating damage, thermal protection is included in the device. If the junction temperature exceeds the typical  $T_{JSD}$  (+150°C TYP), the switching will stop. When the device temperature drops below the threshold minus hysteresis, the switching will resume automatically.

APPLICATION INFORMATION

The device is synchronous Buck converter with fixed output voltage. Taking SGM61014 application as a reference, the following sections discuss the design of external components and how to achieve the application.

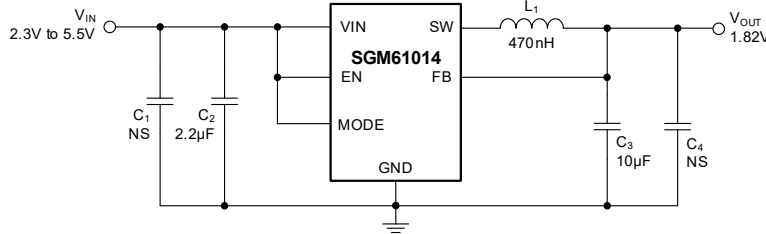

Figure 3. SGM61014 Typical Application Circuit

Requirements

The design parameters given in Table 1 are used for this design example.

Table 1. Design Parameters

Design Parameter	Example Value
Input Voltage	2.3V to 5.5V
Output Voltage	1.82V
Output Ripple Voltage	< 20mV
Output Current (MAX)	1A

Design Details

Table 2 shows the components included in this example.

Table 2. Components List

Reference	Description	Manufacturer
L <sub>1</sub>	470nH, Power Inductor, I <sub>SAT</sub> = 3.3A, I <sub>TEMP</sub> = 2.6A	Standard
C <sub>2</sub>	2.2µF, Ceramic Capacitor, 10V, X5R, Size 0402	Standard
C <sub>3</sub>	10µF, Ceramic Capacitor, 6.3V, X5R, Size 0402	Standard

Inductor Design

Equation 1 is conventionally used to calculate the output inductance of a Buck converter. The inductor should be selected by its value and the saturation current. The saturation current of inductor should be higher than I<sub>L\_MAX</sub> in Equation 1, and sufficient margin should be reserved. More generally, the current above high-side current limit is enough. Larger inductor can reduce the ripple current, but with an increasing response time.

$$I_{L\_MAX} = I_{OUT\_MAX} + \frac{\Delta I_L}{2}$$

$$\Delta I_L = V_{OUT} \times \frac{1 - \frac{V_{OUT}}{V_{IN}}}{L \times f_{SW}} \quad (1)$$

where:

- I<sub>OUT\_MAX</sub> is the maximum output current.
- ΔI<sub>L</sub> is the inductor current ripple.
- f<sub>SW</sub> is the switching frequency.
- L is the inductor value.

Capacitor Design

For input capacitor design, a X5R/X7R dielectric ceramic capacitor should be selected for its low ESR and high-frequency performance. 2.2µF is enough for most applications. The voltage rating of input capacitor must be considered for its significant bias effect. If the input voltage is low, additional input capacitor (C<sub>1</sub>) is recommended. This can be used to prevent a drop in the input voltage from triggering the input UVLO when in load dynamics. The input ripple voltage can be calculated from Equation 2.

$$\Delta V_{IN} = \frac{I_{OUT} \times D \times (1 - D)}{C_{IN} \times f_{SW}} \quad (2)$$

The ripple current rating of input capacitor should be greater than I<sub>CIN\_RMS</sub> in Equation 3 and the maximum value occurs at 50% duty cycle.

$$I_{CIN\_RMS} = I_{OUT} \times \sqrt{\frac{V_{OUT} \times (V_{IN} - V_{OUT})}{V_{IN} \times V_{IN}}} = I_{OUT} \times \sqrt{D \times (1 - D)} \quad (3)$$

For output capacitor design, output ripple, transient response and loop stability should be considered. Minimum capacitance of output ripple criteria can be calculated from Equation 4.

$$C_{OUT} > \frac{\Delta I_L}{8 \times f_{SW} \times V_{OUT\_RIPPLE}} \quad (4)$$

Both the input and output capacitors should be placed as close to VIN and GND pins as possible to reduce noise caused by PCB parasitic parameters.



**APPLICATION INFORMATION (continued)**

**Layout Considerations**

Good PCB layout is the key factor for high performance operation of a device regarding the stability, regulation, efficiency and other performance measures.

A list of guidelines for designing the PCB layout is provided below:

- Place the power components close together and connect them with short and wide routes. The

low-side of the capacitors must be connected to GND properly to avoid potential shift.

- Signal traces are the FB pin, which is sensitive and must be placed away from SW. Connect the inductor to a short trace. The GND of the input capacitor and output capacitor should be placed as close as possible to the GND pin.
- Typical suggested layout is provided in Figure 4.

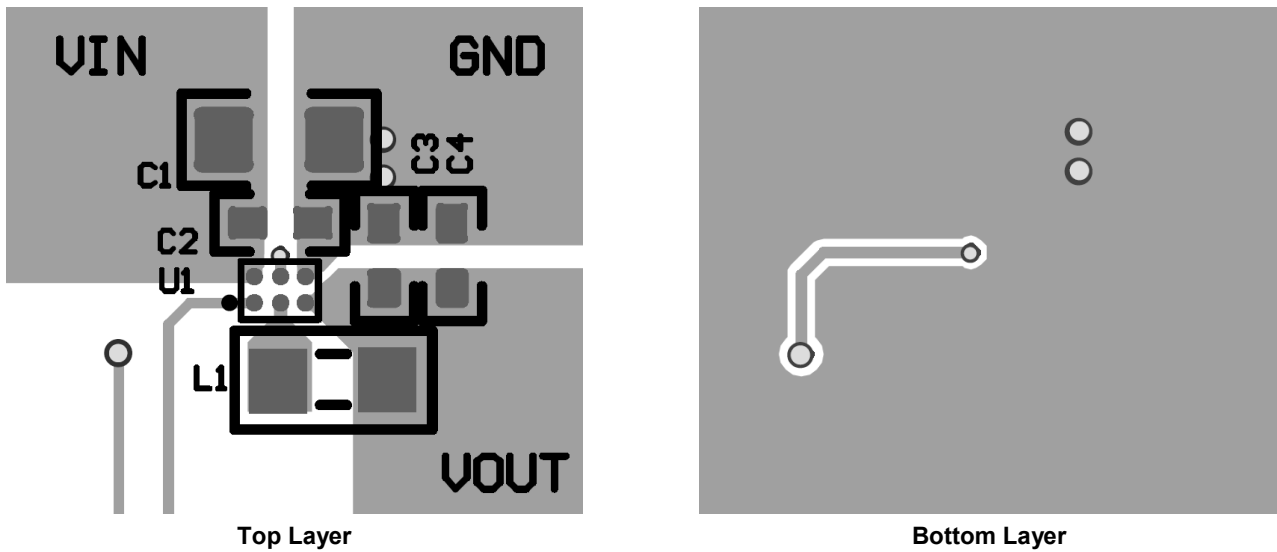

Figure 4. PCB Layout

**REVISION HISTORY**

NOTE: Page numbers for previous revisions may differ from page numbers in the current version.

Changes from Original (DECEMBER 2023) to REV.A	Page
DECEMBER 2023 – REV.A to REV.A.1	
Added typical performance characteristics information .....	6
Changes from Original (DECEMBER 2023) to REV.A	
Changed from Product Preview to Production Data .....	All

# PACKAGE INFORMATION

## PACKAGE OUTLINE DIMENSIONS

### WLCSP-0.86×1.16-6B

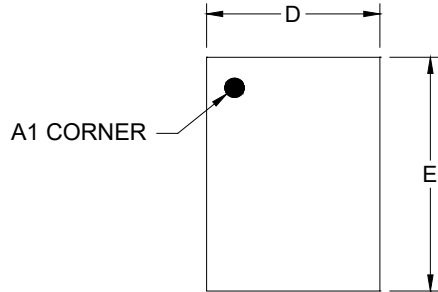

TOP VIEW

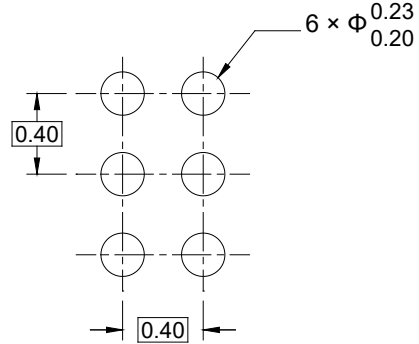

RECOMMENDED LAND PATTERN (Unit: mm)

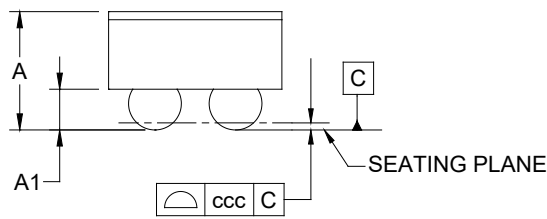

SIDE VIEW

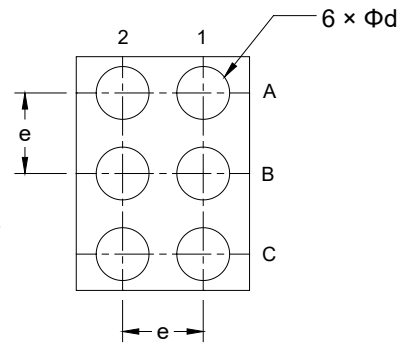

BOTTOM VIEW

Symbol	Dimensions In Millimeters		
	MIN	MOD	MAX
A	-	-	0.625
A1	0.182	-	0.222
D	0.830	-	0.890
E	1.130	-	1.190
d	0.232	-	0.292
e	0.400 BSC		
ccc	0.050		

NOTE: This drawing is subject to change without notice.

# PACKAGE INFORMATION

## TAPE AND REEL INFORMATION

### REEL DIMENSIONS

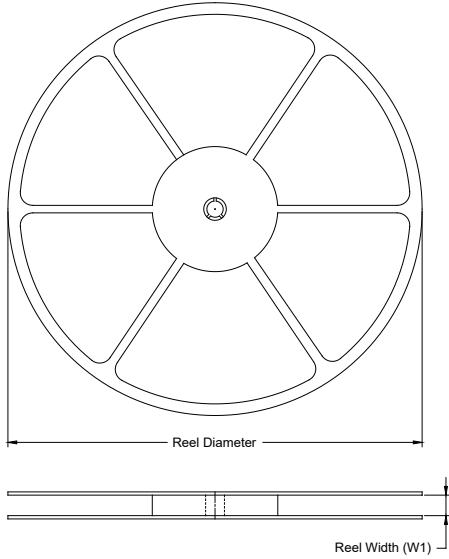

### TAPE DIMENSIONS

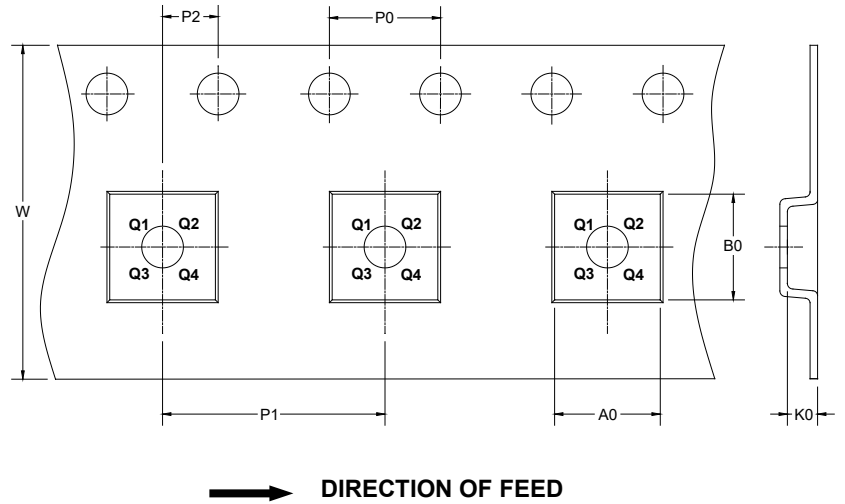

NOTE: The picture is only for reference. Please make the object as the standard.

### KEY PARAMETER LIST OF TAPE AND REEL

Package Type	Reel Diameter	Reel Width W1 (mm)	A0 (mm)	B0 (mm)	K0 (mm)	P0 (mm)	P1 (mm)	P2 (mm)	W (mm)	Pin1 Quadrant
WLCSP-0.86×1.16-6B	7"	9.0	0.97	1.27	0.73	4.0	4.0	2.0	8.0	Q1

000001

# PACKAGE INFORMATION

## CARTON BOX DIMENSIONS



NOTE: The picture is only for reference. Please make the object as the standard.

## KEY PARAMETER LIST OF CARTON BOX

Reel Type	Length (mm)	Width (mm)	Height (mm)	Pizza/Carton
7" (Option)	368	227	224	8
7"	442	410	224	18

DD0002