

GENERAL DESCRIPTION

The SGM818Y is a low power consumption voltage detector with high accuracy detection. It operates with a supply voltage (V_{DD}) range from 0.9V to 6V. It can provide circuit initialization for DSP-based and processor-based systems. The SGM818Y offers tremendous flexibility with an adjustable threshold that is available from 1.2V to 5V with 0.1V increments.

Whenever V_{DD} falls below a factory preset threshold level (V_{TH}), the device will send out a reset signal. This signal will last the whole period until V_{DD} recovers. Once V_{DD} exceeds the release voltage ($V_{TH} + V_{HYS}$), the reset signal will maintain a certain delay time and be released.

The SGM818Y is available in Green SOT-23-3 and UTDFN-1×1-4L packages. It is specified over the -40°C to +125°C operating temperature range.

TYPICAL APPLICATION

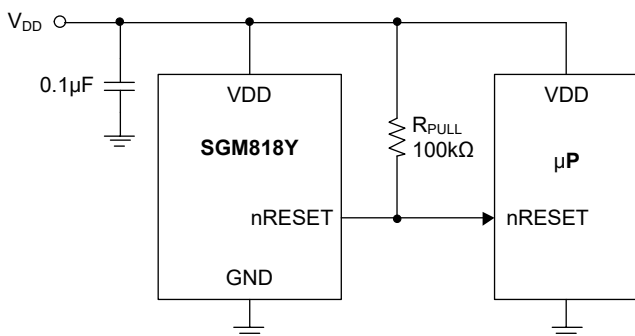

Figure 1. Typical Application Circuit

FEATURES

- **High Accuracy:** $\pm 1\%$ at $T_J = +25^\circ\text{C}$
- **Low Supply Current:** 1 μA (TYP)
- **Detection Voltage Range:** 1.2V to 5V (0.1V Increments)
- **No External Components Required**
- **Quick Reset within 35 μs (TYP)**
- **Reset Active Timeout Period: 6.6ms (nRESET)**
- **Low Functional Supply Voltage: 0.9V**
- **N-Channel Open-Drain Output**
- **Available in Green SOT-23-3 and UTDFN-1×1-4L Packages**

APPLICATIONS

- Computers
- Controllers
- Intelligent Instruments
- Portable Equipment
- μP Power Monitoring
- Battery-Powered Equipment

PACKAGE/ORDERING INFORMATION

MODEL	THRESHOLD VOLTAGE (V)	PACKAGE DESCRIPTION	SPECIFIED TEMPERATURE RANGE	ORDERING NUMBER	PACKAGE MARKING	PACKING OPTION
SGM818Y-1.2	1.2	SOT-23-3	-40°C to +125°C	SGM818Y-1.2XN3G/TR	0USXX	Tape and Reel, 3000
		SOT-23-3 (L-Type)	-40°C to +125°C	SGM818Y-1.2LXN3G/TR	0UTXX	Tape and Reel, 3000
		UTDFN-1×1-4L	-40°C to +125°C	SGM818Y-1.2XUDH4G/TR	08X	Tape and Reel, 10000
SGM818Y-1.3	1.3	SOT-23-3	-40°C to +125°C	SGM818Y-1.3XN3G/TR	0UUXX	Tape and Reel, 3000
		SOT-23-3 (L-Type)	-40°C to +125°C	SGM818Y-1.3LXN3G/TR	0UVXX	Tape and Reel, 3000
		UTDFN-1×1-4L	-40°C to +125°C	SGM818Y-1.3XUDH4G/TR	09X	Tape and Reel, 10000
SGM818Y-1.4	1.4	SOT-23-3	-40°C to +125°C	SGM818Y-1.4XN3G/TR	0UWXX	Tape and Reel, 3000
		SOT-23-3 (L-Type)	-40°C to +125°C	SGM818Y-1.4LXN3G/TR	0UXXX	Tape and Reel, 3000
		UTDFN-1×1-4L	-40°C to +125°C	SGM818Y-1.4XUDH4G/TR	0AX	Tape and Reel, 10000
SGM818Y-1.5	1.5	SOT-23-3	-40°C to +125°C	SGM818Y-1.5XN3G/TR	0UYXX	Tape and Reel, 3000
		SOT-23-3 (L-Type)	-40°C to +125°C	SGM818Y-1.5LXN3G/TR	0UZXX	Tape and Reel, 3000
		UTDFN-1×1-4L	-40°C to +125°C	SGM818Y-1.5XUDH4G/TR	0GX	Tape and Reel, 10000
SGM818Y-1.6	1.6	SOT-23-3	-40°C to +125°C	SGM818Y-1.6XN3G/TR	0UFXX	Tape and Reel, 3000
		SOT-23-3 (L-Type)	-40°C to +125°C	SGM818Y-1.6LXN3G/TR	0NTXX	Tape and Reel, 3000
		UTDFN-1×1-4L	-40°C to +125°C	SGM818Y-1.6XUDH4G/TR	06X	Tape and Reel, 10000
SGM818Y-1.7	1.7	SOT-23-3	-40°C to +125°C	SGM818Y-1.7XN3G/TR	0V0XX	Tape and Reel, 3000
		SOT-23-3 (L-Type)	-40°C to +125°C	SGM818Y-1.7LXN3G/TR	0V1XX	Tape and Reel, 3000
		UTDFN-1×1-4L	-40°C to +125°C	SGM818Y-1.7XUDH4G/TR	0HX	Tape and Reel, 10000
SGM818Y-1.8	1.8	SOT-23-3	-40°C to +125°C	SGM818Y-1.8XN3G/TR	0V2XX	Tape and Reel, 3000
		SOT-23-3 (L-Type)	-40°C to +125°C	SGM818Y-1.8LXN3G/TR	0V3XX	Tape and Reel, 3000
		UTDFN-1×1-4L	-40°C to +125°C	SGM818Y-1.8XUDH4G/TR	0IX	Tape and Reel, 10000
SGM818Y-1.9	1.9	SOT-23-3	-40°C to +125°C	SGM818Y-1.9XN3G/TR	0V4XX	Tape and Reel, 3000
		SOT-23-3 (L-Type)	-40°C to +125°C	SGM818Y-1.9LXN3G/TR	0V5XX	Tape and Reel, 3000
		UTDFN-1×1-4L	-40°C to +125°C	SGM818Y-1.9XUDH4G/TR	0JX	Tape and Reel, 10000
SGM818Y-2.0	2	SOT-23-3	-40°C to +125°C	SGM818Y-2.0XN3G/TR	0V6XX	Tape and Reel, 3000
		SOT-23-3 (L-Type)	-40°C to +125°C	SGM818Y-2.0LXN3G/TR	0V7XX	Tape and Reel, 3000
		UTDFN-1×1-4L	-40°C to +125°C	SGM818Y-2.0XUDH4G/TR	0KX	Tape and Reel, 10000

PACKAGE/ORDERING INFORMATION (continued)

MODEL	THRESHOLD VOLTAGE (V)	PACKAGE DESCRIPTION	SPECIFIED TEMPERATURE RANGE	ORDERING NUMBER	PACKAGE MARKING	PACKING OPTION
SGM818Y-2.1	2.1	SOT-23-3	-40°C to +125°C	SGM818Y-2.1XN3G/TR	0V8XX	Tape and Reel, 3000
		SOT-23-3 (L-Type)	-40°C to +125°C	SGM818Y-2.1LXN3G/TR	0V9XX	Tape and Reel, 3000
		UTDFN-1×1-4L	-40°C to +125°C	SGM818Y-2.1XUDH4G/TR	0LX	Tape and Reel, 10000
SGM818Y-2.2	2.2	SOT-23-3	-40°C to +125°C	SGM818Y-2.2XN3G/TR	0VAXX	Tape and Reel, 3000
		SOT-23-3 (L-Type)	-40°C to +125°C	SGM818Y-2.2LXN3G/TR	0VBXX	Tape and Reel, 3000
		UTDFN-1×1-4L	-40°C to +125°C	SGM818Y-2.2XUDH4G/TR	0MX	Tape and Reel, 10000
SGM818Y-2.3	2.3	SOT-23-3	-40°C to +125°C	SGM818Y-2.3XN3G/TR	0VCXX	Tape and Reel, 3000
		SOT-23-3 (L-Type)	-40°C to +125°C	SGM818Y-2.3LXN3G/TR	0VDXX	Tape and Reel, 3000
		UTDFN-1×1-4L	-40°C to +125°C	SGM818Y-2.3XUDH4G/TR	0NX	Tape and Reel, 10000
SGM818Y-2.4	2.4	SOT-23-3	-40°C to +125°C	SGM818Y-2.4XN3G/TR	0VEXX	Tape and Reel, 3000
		SOT-23-3 (L-Type)	-40°C to +125°C	SGM818Y-2.4LXN3G/TR	0VFXX	Tape and Reel, 3000
		UTDFN-1×1-4L	-40°C to +125°C	SGM818Y-2.4XUDH4G/TR	0OX	Tape and Reel, 10000
SGM818Y-2.5	2.5	SOT-23-3	-40°C to +125°C	SGM818Y-2.5XN3G/TR	0VGXX	Tape and Reel, 3000
		SOT-23-3 (L-Type)	-40°C to +125°C	SGM818Y-2.5LXN3G/TR	0VHXX	Tape and Reel, 3000
		UTDFN-1×1-4L	-40°C to +125°C	SGM818Y-2.5XUDH4G/TR	0PX	Tape and Reel, 10000
SGM818Y-2.6	2.6	SOT-23-3	-40°C to +125°C	SGM818Y-2.6XN3G/TR	0VIXX	Tape and Reel, 3000
		SOT-23-3 (L-Type)	-40°C to +125°C	SGM818Y-2.6LXN3G/TR	0VJXX	Tape and Reel, 3000
		UTDFN-1×1-4L	-40°C to +125°C	SGM818Y-2.6XUDH4G/TR	0QX	Tape and Reel, 10000
SGM818Y-2.7	2.7	SOT-23-3	-40°C to +125°C	SGM818Y-2.7XN3G/TR	0VKXX	Tape and Reel, 3000
		SOT-23-3 (L-Type)	-40°C to +125°C	SGM818Y-2.7LXN3G/TR	0VLXX	Tape and Reel, 3000
		UTDFN-1×1-4L	-40°C to +125°C	SGM818Y-2.7XUDH4G/TR	0RX	Tape and Reel, 10000
SGM818Y-2.8	2.8	SOT-23-3	-40°C to +125°C	SGM818Y-2.8XN3G/TR	0VNXX	Tape and Reel, 3000
		SOT-23-3 (L-Type)	-40°C to +125°C	SGM818Y-2.8LXN3G/TR	0VOXX	Tape and Reel, 3000
		UTDFN-1×1-4L	-40°C to +125°C	SGM818Y-2.8XUDH4G/TR	0SX	Tape and Reel, 10000
SGM818Y-2.9	2.9	SOT-23-3	-40°C to +125°C	SGM818Y-2.9XN3G/TR	0UGXX	Tape and Reel, 3000
		SOT-23-3 (L-Type)	-40°C to +125°C	SGM818Y-2.9LXN3G/TR	0UEXX	Tape and Reel, 3000
		UTDFN-1×1-4L	-40°C to +125°C	SGM818Y-2.9XUDH4G/TR	07X	Tape and Reel, 10000

PACKAGE/ORDERING INFORMATION (continued)

MODEL	THRESHOLD VOLTAGE (V)	PACKAGE DESCRIPTION	SPECIFIED TEMPERATURE RANGE	ORDERING NUMBER	PACKAGE MARKING	PACKING OPTION
SGM818Y-3.0	3	SOT-23-3	-40°C to +125°C	SGM818Y-3.0XN3G/TR	0VQXX	Tape and Reel, 3000
		SOT-23-3 (L-Type)	-40°C to +125°C	SGM818Y-3.0LXN3G/TR	0VRXX	Tape and Reel, 3000
		UTDFN-1×1-4L	-40°C to +125°C	SGM818Y-3.0XUDH4G/TR	0TX	Tape and Reel, 10000
SGM818Y-3.1	3.1	SOT-23-3	-40°C to +125°C	SGM818Y-3.1XN3G/TR	0VSXX	Tape and Reel, 3000
		SOT-23-3 (L-Type)	-40°C to +125°C	SGM818Y-3.1LXN3G/TR	0VTXX	Tape and Reel, 3000
		UTDFN-1×1-4L	-40°C to +125°C	SGM818Y-3.1XUDH4G/TR	0UX	Tape and Reel, 10000
SGM818Y-3.2	3.2	SOT-23-3	-40°C to +125°C	SGM818Y-3.2XN3G/TR	0VVXX	Tape and Reel, 3000
		SOT-23-3 (L-Type)	-40°C to +125°C	SGM818Y-3.2LXN3G/TR	0VWXX	Tape and Reel, 3000
		UTDFN-1×1-4L	-40°C to +125°C	SGM818Y-3.2XUDH4G/TR	0VX	Tape and Reel, 10000
SGM818Y-3.3	3.3	SOT-23-3	-40°C to +125°C	SGM818Y-3.3XN3G/TR	0VYXX	Tape and Reel, 3000
		SOT-23-3 (L-Type)	-40°C to +125°C	SGM818Y-3.3LXN3G/TR	0VZXX	Tape and Reel, 3000
		UTDFN-1×1-4L	-40°C to +125°C	SGM818Y-3.3XUDH4G/TR	0WX	Tape and Reel, 10000
SGM818Y-3.4	3.4	SOT-23-3	-40°C to +125°C	SGM818Y-3.4XN3G/TR	0W0XX	Tape and Reel, 3000
		SOT-23-3 (L-Type)	-40°C to +125°C	SGM818Y-3.4LXN3G/TR	0W1XX	Tape and Reel, 3000
		UTDFN-1×1-4L	-40°C to +125°C	SGM818Y-3.4XUDH4G/TR	0XX	Tape and Reel, 10000
SGM818Y-3.5	3.5	SOT-23-3	-40°C to +125°C	SGM818Y-3.5XN3G/TR	0W2XX	Tape and Reel, 3000
		SOT-23-3 (L-Type)	-40°C to +125°C	SGM818Y-3.5LXN3G/TR	0W3XX	Tape and Reel, 3000
		UTDFN-1×1-4L	-40°C to +125°C	SGM818Y-3.5XUDH4G/TR	0YX	Tape and Reel, 10000
SGM818Y-3.6	3.6	SOT-23-3	-40°C to +125°C	SGM818Y-3.6XN3G/TR	0W4XX	Tape and Reel, 3000
		SOT-23-3 (L-Type)	-40°C to +125°C	SGM818Y-3.6LXN3G/TR	0W5XX	Tape and Reel, 3000
		UTDFN-1×1-4L	-40°C to +125°C	SGM818Y-3.6XUDH4G/TR	0ZX	Tape and Reel, 10000
SGM818Y-3.7	3.7	SOT-23-3	-40°C to +125°C	SGM818Y-3.7XN3G/TR	0W6XX	Tape and Reel, 3000
		SOT-23-3 (L-Type)	-40°C to +125°C	SGM818Y-3.7LXN3G/TR	0W7XX	Tape and Reel, 3000
		UTDFN-1×1-4L	-40°C to +125°C	SGM818Y-3.7XUDH4G/TR	10X	Tape and Reel, 10000
SGM818Y-3.8	3.8	SOT-23-3	-40°C to +125°C	SGM818Y-3.8XN3G/TR	0W9XX	Tape and Reel, 3000
		SOT-23-3 (L-Type)	-40°C to +125°C	SGM818Y-3.8LXN3G/TR	0WAXX	Tape and Reel, 3000
		UTDFN-1×1-4L	-40°C to +125°C	SGM818Y-3.8XUDH4G/TR	11X	Tape and Reel, 10000

PACKAGE/ORDERING INFORMATION (continued)

MODEL	THRESHOLD VOLTAGE (V)	PACKAGE DESCRIPTION	SPECIFIED TEMPERATURE RANGE	ORDERING NUMBER	PACKAGE MARKING	PACKING OPTION
SGM818Y-3.9	3.9	SOT-23-3	-40°C to +125°C	SGM818Y-3.9XN3G/TR	0WBXX	Tape and Reel, 3000
		SOT-23-3 (L-Type)	-40°C to +125°C	SGM818Y-3.9LXN3G/TR	0WCXX	Tape and Reel, 3000
		UTDFN-1×1-4L	-40°C to +125°C	SGM818Y-3.9XUDH4G/TR	12X	Tape and Reel, 10000
SGM818Y-4.0	4	SOT-23-3	-40°C to +125°C	SGM818Y-4.0XN3G/TR	0WDXX	Tape and Reel, 3000
		SOT-23-3 (L-Type)	-40°C to +125°C	SGM818Y-4.0LXN3G/TR	0WEXX	Tape and Reel, 3000
		UTDFN-1×1-4L	-40°C to +125°C	SGM818Y-4.0XUDH4G/TR	13X	Tape and Reel, 10000
SGM818Y-4.1	4.1	SOT-23-3	-40°C to +125°C	SGM818Y-4.1XN3G/TR	0WFXX	Tape and Reel, 3000
		SOT-23-3 (L-Type)	-40°C to +125°C	SGM818Y-4.1LXN3G/TR	0WGXX	Tape and Reel, 3000
		UTDFN-1×1-4L	-40°C to +125°C	SGM818Y-4.1XUDH4G/TR	15X	Tape and Reel, 10000
SGM818Y-4.2	4.2	SOT-23-3	-40°C to +125°C	SGM818Y-4.2XN3G/TR	0WHXX	Tape and Reel, 3000
		SOT-23-3 (L-Type)	-40°C to +125°C	SGM818Y-4.2LXN3G/TR	0WIXX	Tape and Reel, 3000
		UTDFN-1×1-4L	-40°C to +125°C	SGM818Y-4.2XUDH4G/TR	16X	Tape and Reel, 10000
SGM818Y-4.3	4.3	SOT-23-3	-40°C to +125°C	SGM818Y-4.3XN3G/TR	0WJXX	Tape and Reel, 3000
		SOT-23-3 (L-Type)	-40°C to +125°C	SGM818Y-4.3LXN3G/TR	0WKXX	Tape and Reel, 3000
		UTDFN-1×1-4L	-40°C to +125°C	SGM818Y-4.3XUDH4G/TR	17X	Tape and Reel, 10000
SGM818Y-4.4	4.4	SOT-23-3	-40°C to +125°C	SGM818Y-4.4XN3G/TR	0WLXX	Tape and Reel, 3000
		SOT-23-3 (L-Type)	-40°C to +125°C	SGM818Y-4.4LXN3G/TR	0WMXX	Tape and Reel, 3000
		UTDFN-1×1-4L	-40°C to +125°C	SGM818Y-4.4XUDH4G/TR	18X	Tape and Reel, 10000
SGM818Y-4.5	4.5	SOT-23-3	-40°C to +125°C	SGM818Y-4.5XN3G/TR	0WNXX	Tape and Reel, 3000
		SOT-23-3 (L-Type)	-40°C to +125°C	SGM818Y-4.5LXN3G/TR	0WOXX	Tape and Reel, 3000
		UTDFN-1×1-4L	-40°C to +125°C	SGM818Y-4.5XUDH4G/TR	19X	Tape and Reel, 10000
SGM818Y-4.6	4.6	SOT-23-3	-40°C to +125°C	SGM818Y-4.6XN3G/TR	0WPXX	Tape and Reel, 3000
		SOT-23-3 (L-Type)	-40°C to +125°C	SGM818Y-4.6LXN3G/TR	0WQXX	Tape and Reel, 3000
		UTDFN-1×1-4L	-40°C to +125°C	SGM818Y-4.6XUDH4G/TR	1AX	Tape and Reel, 10000
SGM818Y-4.7	4.7	SOT-23-3	-40°C to +125°C	SGM818Y-4.7XN3G/TR	0WRXX	Tape and Reel, 3000
		SOT-23-3 (L-Type)	-40°C to +125°C	SGM818Y-4.7LXN3G/TR	0WSXX	Tape and Reel, 3000
		UTDFN-1×1-4L	-40°C to +125°C	SGM818Y-4.7XUDH4G/TR	1GX	Tape and Reel, 10000

PACKAGE/ORDERING INFORMATION (continued)

MODEL	THRESHOLD VOLTAGE (V)	PACKAGE DESCRIPTION	SPECIFIED TEMPERATURE RANGE	ORDERING NUMBER	PACKAGE MARKING	PACKING OPTION
SGM818Y-4.8	4.8	SOT-23-3	-40°C to +125°C	SGM818Y-4.8XN3G/TR	0WUXX	Tape and Reel, 3000
		SOT-23-3 (L-Type)	-40°C to +125°C	SGM818Y-4.8LXN3G/TR	0WVXX	Tape and Reel, 3000
		UTDFN-1×1-4L	-40°C to +125°C	SGM818Y-4.8XUDH4G/TR	1HX	Tape and Reel, 10000
SGM818Y-4.9	4.9	SOT-23-3	-40°C to +125°C	SGM818Y-4.9XN3G/TR	0WWXX	Tape and Reel, 3000
		SOT-23-3 (L-Type)	-40°C to +125°C	SGM818Y-4.9LXN3G/TR	0WXXX	Tape and Reel, 3000
		UTDFN-1×1-4L	-40°C to +125°C	SGM818Y-4.9XUDH4G/TR	1IX	Tape and Reel, 10000
SGM818Y-5.0	5	SOT-23-3	-40°C to +125°C	SGM818Y-5.0XN3G/TR	0WYXX	Tape and Reel, 3000
		SOT-23-3 (L-Type)	-40°C to +125°C	SGM818Y-5.0LXN3G/TR	0WZXX	Tape and Reel, 3000
		UTDFN-1×1-4L	-40°C to +125°C	SGM818Y-5.0XUDH4G/TR	1JX	Tape and Reel, 10000

MARKING INFORMATION

NOTE: X = Date Code.

SOT-23-3

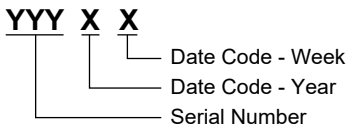

UTDFN-1×1-4L

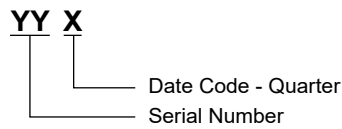

Green (RoHS & HSF): SG Micro Corp defines "Green" to mean Pb-Free (RoHS compatible) and free of halogen substances. If you have additional comments or questions, please contact your SGMICRO representative directly.

ABSOLUTE MAXIMUM RATINGS

- Terminal Voltage (with Respect to GND), V_{DD} -0.3V to 6V
- All Other Inputs -0.3V to 6V
- Input Current, I_{nRESET} 20mA
- Package Thermal Resistance
- SOT-23-3, θ_{JA} 255.2°C/W
- SOT-23-3, θ_{JB} 111.9°C/W
- SOT-23-3, θ_{JC} 147.7°C/W
- UTDFN-1×1-4L, θ_{JA} 218.2°C/W
- UTDFN-1×1-4L, θ_{JB} 157.9°C/W
- UTDFN-1×1-4L, θ_{JC_TOP} 183.5°C/W
- UTDFN-1×1-4L, θ_{JC_BOT} 154.1°C/W
- Junction Temperature +150°C
- Storage Temperature Range -65°C to +150°C
- Lead Temperature (Soldering, 10s) +260°C
- ESD Susceptibility
- HBM 4000V
- CDM 1000V

OVERSTRESS CAUTION

Stresses beyond those listed in Absolute Maximum Ratings may cause permanent damage to the device. Exposure to absolute maximum rating conditions for extended periods may affect reliability. Functional operation of the device at any conditions beyond those indicated in the Recommended Operating Conditions section is not implied.

ESD SENSITIVITY CAUTION

This integrated circuit can be damaged if ESD protections are not considered carefully. SGMICRO recommends that all integrated circuits be handled with appropriate precautions. Failure to observe proper handling and installation procedures can cause damage. ESD damage can range from subtle performance degradation to complete device failure. Precision integrated circuits may be more susceptible to damage because even small parametric changes could cause the device not to meet the published specifications.

RECOMMENDED OPERATING CONDITIONS

- Operating Junction Temperature Range -40°C to +125°C

DISCLAIMER

SG Micro Corp reserves the right to make any change in circuit design, or specifications without prior notice.

PIN CONFIGURATIONS

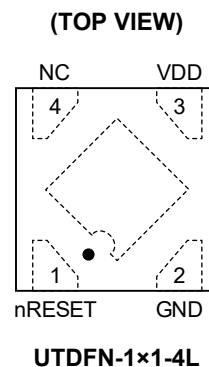
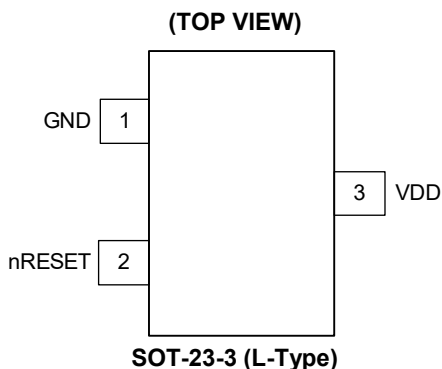
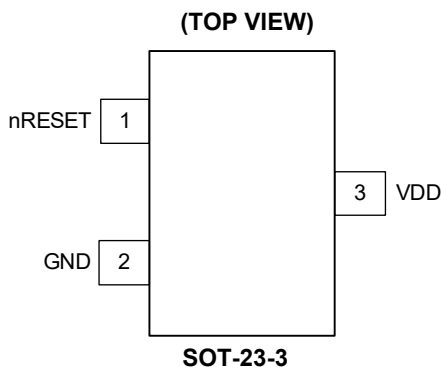

PIN DESCRIPTION

PIN			NAME	FUNCTION
SOT-23-3	SOT-23-3 (L-Type)	UTDFN-1x1-4L		
1	2	1	nRESET	Active-Low Reset Output Pin.
2	1	2	GND	Ground.
3	3	3	VDD	Power Pin.
—	—	4	NC	No Connection.

ELECTRICAL CHARACTERISTICS

($V_{DD} = 3V$, $T_J = +25^{\circ}C$, unless otherwise noted.)

PARAMETER	SYMBOL	CONDITIONS	MIN	TYP	MAX	UNITS
Operating V_{DD} Range	V_{DD}		0.9		6	V
Supply Current	I_{DD}	$V_{TH} = 3V$, $V_{DD} = 4.5V$, $T_J = +25^{\circ}C$		1	2	μA
Reset Threshold	V_{TH}			1.2 to 5		V
Threshold Voltage Accuracy	ΔV_{TH}	$T_J = +25^{\circ}C$	-1		1	%
V_{DD} Drop to Reset Delay	t_{RD}	Drop = $V_{TH} - 125mV$		37		μs
Reset Active Timeout Period	t_{RP}	$V_{DD} \geq 1.02 \times V_{TH}$	3.2	6.6	10.2	ms
Reset Output Voltage Low ⁽¹⁾	V_{OL}	$1.5V = V_{DD} < V_{TH}$, $I_{SINK} = 3.5mA$			0.4	V
Hysteresis Width	V_{HYS}			$0.64\% \times V_{TH}$	$1.6\% \times V_{TH}$	V

NOTE:

1. V_{OL} can be calculated by $V_{OL} = V_{DD} - I_R \times R_{PU}$, where R_{PU} is the pull-up resistor and I_R is the current flowing through the pull-up resistor. For typical application, R_{PU} is 100k Ω and V_{OL} is less than 0.2V.

TIMING DIAGRAM

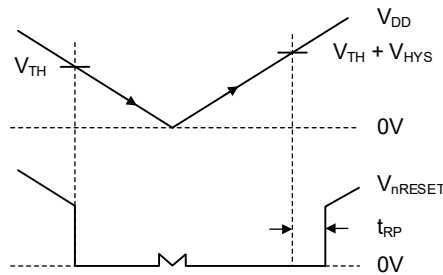
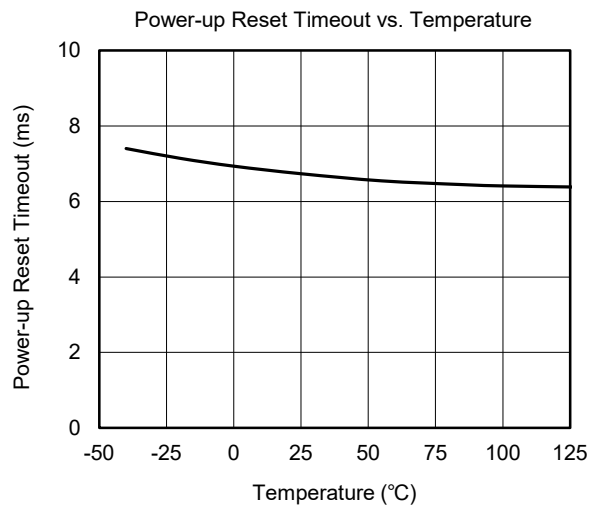
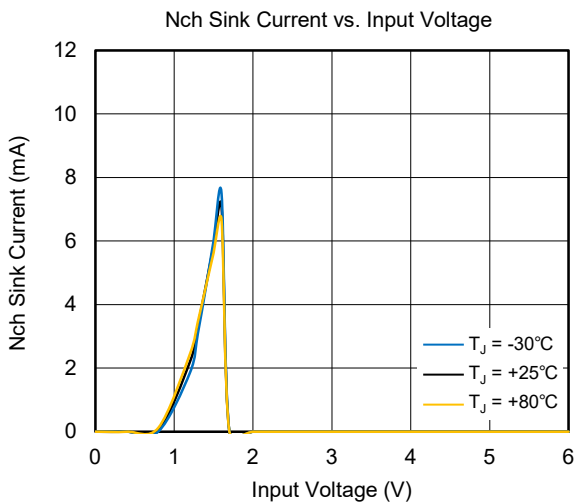
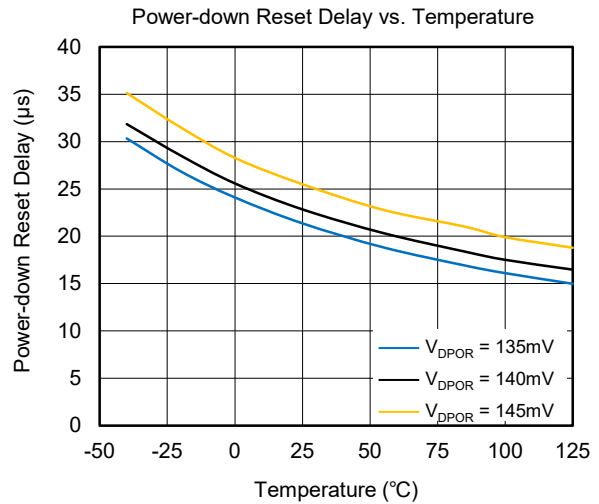
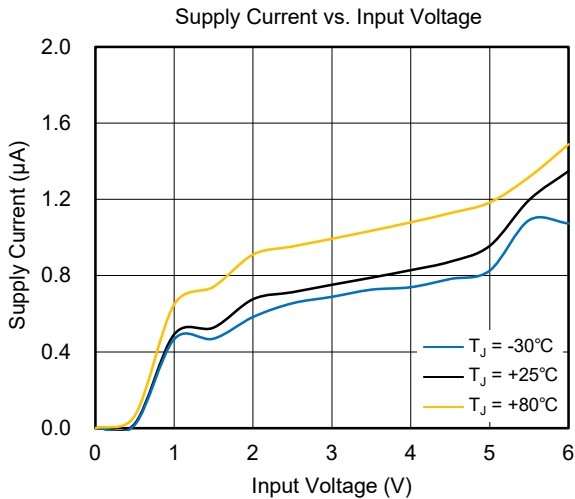
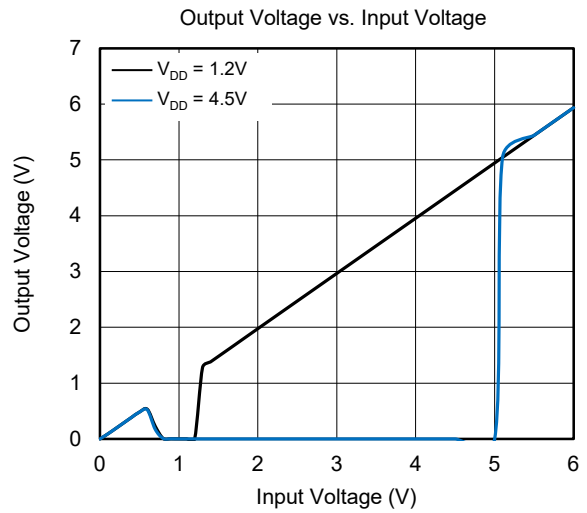
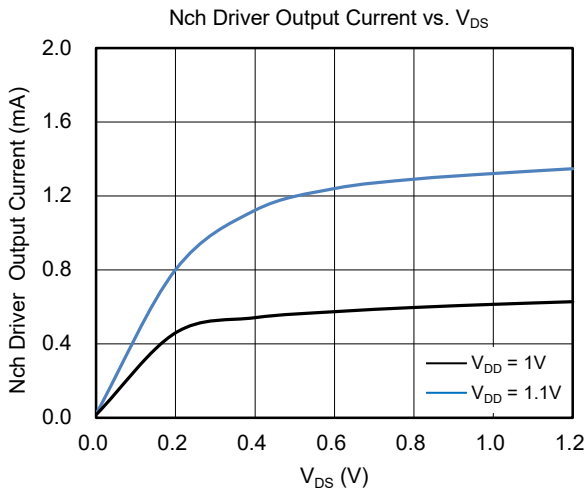
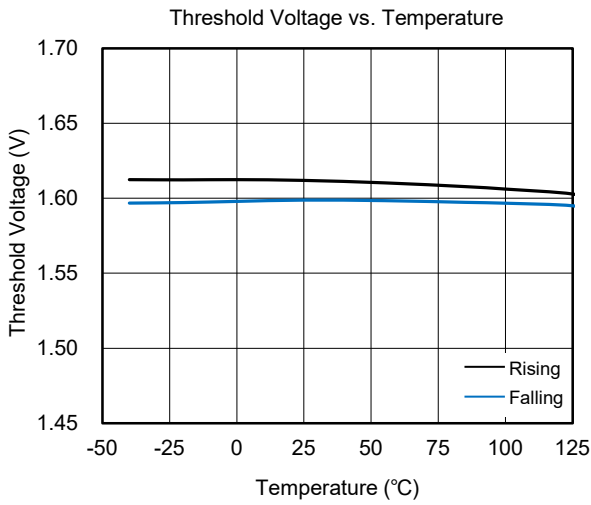

Figure 2. Timing Diagram

TYPICAL PERFORMANCE CHARACTERISTICS



TYPICAL PERFORMANCE CHARACTERISTICS (continued)



FUNCTIONAL BLOCK DIAGRAM

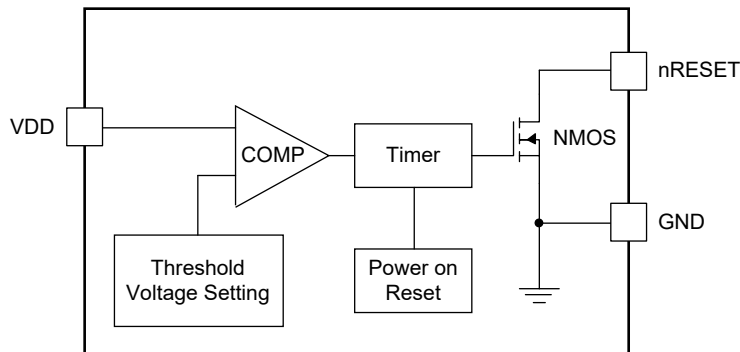

Figure 3. Block Diagram

APPLICATION INFORMATION

Multiple Supplies

The pull-up resistor connected to the SGM818Y will be connected to the supply voltage monitored on the VDD pin of the IC. However, the systems using open-drain output can level-shift the monitored supply voltages into the reset circuit powered by some other supply.

High Accuracy of the Reset Threshold

The reset threshold voltages of most μP supervisor ICs are 1% to 1.5% lower than the nominal supply voltages. If the voltage is within 1% of the nominal supply, the reset will not assert, and if the voltage is within 1.5% of the nominal supply, the reset will assert.

REVISION HISTORY

NOTE: Page numbers for previous revisions may differ from page numbers in the current version.

MAY 2024 – REV.A to REV.A.1	Page
Added UTDFN-1×1-4L Package	All
Changed Electrical Characteristics section	8

Changes from Original (MARCH 2024) to REV.A	Page
Changed from product preview to production data.....	All

PACKAGE OUTLINE DIMENSIONS

SOT-23-3

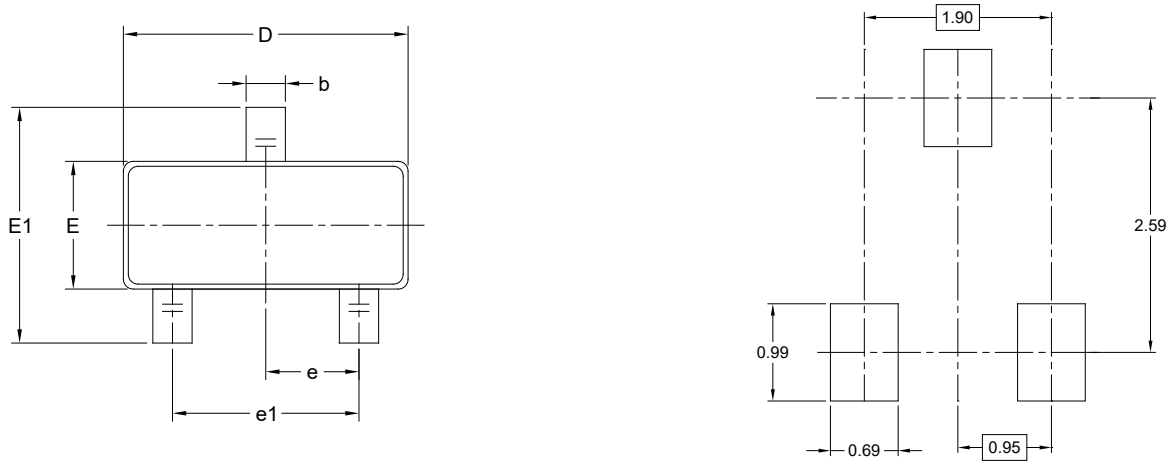

RECOMMENDED LAND PATTERN (Unit: mm)

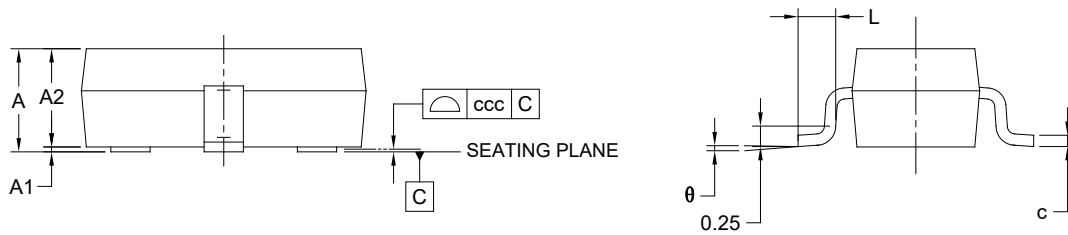

Symbol	Dimensions In Millimeters		
	MIN	MOD	MAX
A	-	-	1.450
A1	0.000	-	0.150
A2	0.900	-	1.300
b	0.300	-	0.500
c	0.080	-	0.220
D	2.750	-	3.050
E	1.450	-	1.750
E1	2.600	-	3.000
e	0.950 BSC		
e1	1.900 BSC		
L	0.300	-	0.600
θ	0°	-	8°
ccc	0.100		

NOTES:

1. This drawing is subject to change without notice.
2. The dimensions do not include mold flashes, protrusions or gate burrs.
3. Reference JEDEC MO-178.

PACKAGE OUTLINE DIMENSIONS

UTDFN-1x1-4L

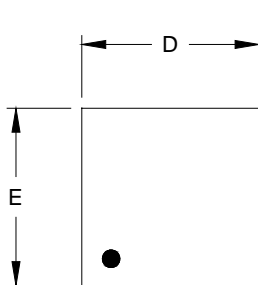

TOP VIEW

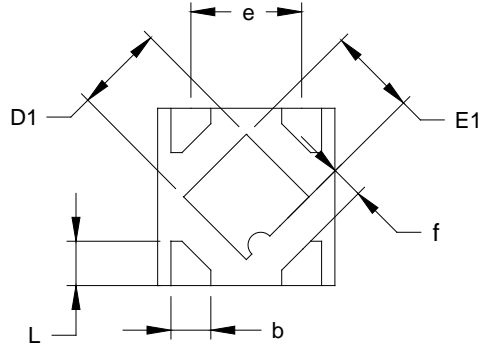

BOTTOM VIEW

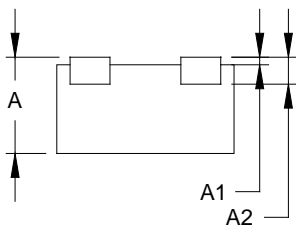

SIDE VIEW

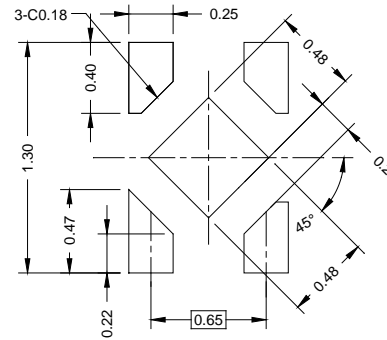

RECOMMENDED LAND PATTERN (Unit: mm)

Symbol	Dimensions In Millimeters		
	MIN	MOD	MAX
A	0.500	0.550	0.600
A1	0.000		0.050
A2	0.152 REF		
D	0.950	1.000	1.050
D1	0.450	0.500	0.550
E	0.950	1.000	1.050
E1	0.450	0.500	0.550
b	0.175	0.225	0.275
e	0.625 BSC		
f	0.195 REF		
L	0.200	0.250	0.300

NOTE: This drawing is subject to change without notice.

TAPE AND REEL INFORMATION

REEL DIMENSIONS



TAPE DIMENSIONS



NOTE: The picture is only for reference. Please make the object as the standard.

KEY PARAMETER LIST OF TAPE AND REEL

Package Type	Reel Diameter	Reel Width W1 (mm)	A0 (mm)	B0 (mm)	K0 (mm)	P0 (mm)	P1 (mm)	P2 (mm)	W (mm)	Pin1 Quadrant
SOT-23-3	7"	9.5	3.18	3.28	1.32	4.0	4.0	2.0	8.0	Q3
UTDFN-1×1-4L	7"	9.0	1.18	1.18	0.68	4.0	2.0	2.0	8.0	Q1

DD0001

PACKAGE INFORMATION

CARTON BOX DIMENSIONS



NOTE: The picture is only for reference. Please make the object as the standard.

KEY PARAMETER LIST OF CARTON BOX

Reel Type	Length (mm)	Width (mm)	Height (mm)	Pizza/Carton
7" (Option)	368	227	224	8
7"	442	410	224	18

DD0002