

GENERAL DESCRIPTION

The SGM2523C/D are compact electronic fuses (eFuses) with a complete set of protection functions. The wide operating voltage range is specifically designed for many popular DC buses. The devices provide $\pm 10\%$ current limit accuracy which is suitable for a wide range of system protection applications.

The programmable soft-start time controls the slew rate of the output voltage during the power-up procedure.

The devices protect input from undesired shorts and transients coming from the output.

The SGM2523C/D are available in a Green SOT-23-6 package and operate over a temperature range of -40°C to $+125^{\circ}\text{C}$.

APPLICATIONS

- Hot Swap in Industry/Telecom
- E-Meter
- Automotive
- USB Power Distribution
- USB3.1 Power Delivery
- Adapter Power Device

TYPICAL APPLICATION

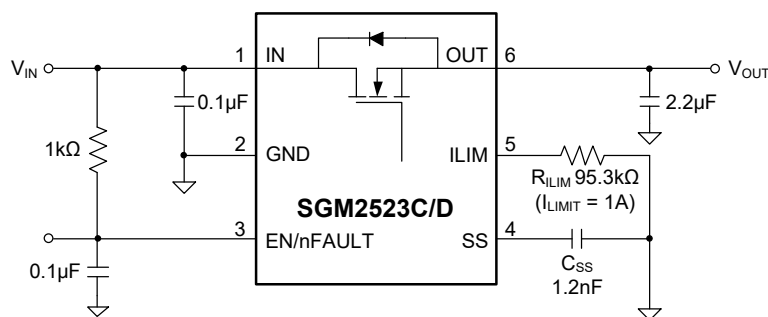

Figure 1. Typical Application Circuit

FEATURES

- Wide Input Voltage Range from 2.6V to 22V with Surge up to 30V
- Low $R_{DS(ON)}$ for the Integrated Protection Switch: 75m Ω
- Programmable Soft-Start Time
- Programmable Current Limit from 100mA to 1.2A
- $\pm 10\%$ Current Limit Accuracy at $T_J = +25^{\circ}\text{C}$
- Short-Circuit Protection
- OCP Hiccup Protections:
 - SGM2523C: Limited Current Mode
 - SGM2523D: Shutdown Mode
- Thermal Shutdown Options:
 - SGM2523C: Auto-Retry
 - SGM2523D: Latch-Off
- Enable Interface Pin
- -40°C to $+125^{\circ}\text{C}$ Operating Temperature Range
- Available in a Green SOT-23-6 Package

PACKAGE/ORDERING INFORMATION

MODEL	PACKAGE DESCRIPTION	SPECIFIED TEMPERATURE RANGE	ORDERING NUMBER	PACKAGE MARKING	PACKING OPTION
SGM2523C	SOT-23-6	-40°C to +125°C	SGM2523CXN6G/TR	ON6XX	Tape and Reel, 3000
SGM2523D	SOT-23-6	-40°C to +125°C	SGM2523DXN6G/TR	SGWXX	Tape and Reel, 3000

MARKING INFORMATION

NOTE: XX = Date Code.

YYY X X

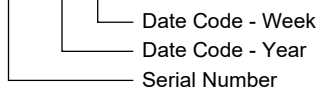

Green (RoHS & HSF): SG Micro Corp defines "Green" to mean Pb-Free (RoHS compatible) and free of halogen substances. If you have additional comments or questions, please contact your SGMICRO representative directly.

ABSOLUTE MAXIMUM RATINGS

IN, OUT, EN/nFAULT to GND	-0.3V to 26V
SS, ILIM to GND	-0.3V to 6V
Package Thermal Resistance	
SOT-23-6, θ_{JA}	220°C/W
Junction Temperature	+150°C
Storage Temperature Range.....	-65°C to +150°C
Lead Temperature (Soldering, 10s)	+260°C
ESD Susceptibility	
HBM.....	4000V
CDM	1000V

RECOMMENDED OPERATING CONDITIONS

Input Voltage Range	2.6V to 22V
Operating Junction Temperature Range.....	-40°C to +125°C

OVERSTRESS CAUTION

Stresses beyond those listed in Absolute Maximum Ratings may cause permanent damage to the device. Exposure to absolute maximum rating conditions for extended periods may affect reliability. Functional operation of the device at any conditions beyond those indicated in the Recommended Operating Conditions section is not implied.

ESD SENSITIVITY CAUTION

This integrated circuit can be damaged if ESD protections are not considered carefully. SGMICRO recommends that all integrated circuits be handled with appropriate precautions. Failure to observe proper handling and installation procedures can cause damage. ESD damage can range from subtle performance degradation to complete device failure. Precision integrated circuits may be more susceptible to damage because even small parametric changes could cause the device not to meet the published specifications.

DISCLAIMER

SG Micro Corp reserves the right to make any change in circuit design, or specifications without prior notice.

PIN CONFIGURATION

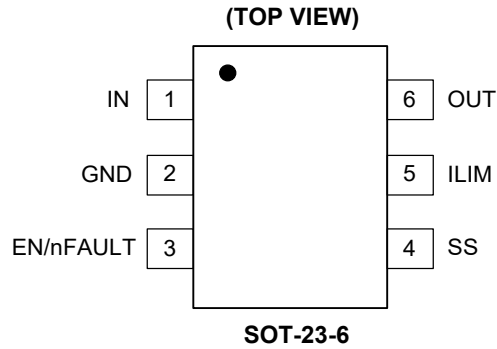

PIN DESCRIPTION

PIN	NAME	FUNCTION
1	IN	Power Input Pin. Decouple high frequency noise by connecting at least a 0.1μF ceramic capacitor to ground.
2	GND	Ground.
3	EN/nFAULT	Enable Input or Alert Output (OTP, OCP, SCP). Asserting EN/nFAULT pin high enables the device. When any of over-temperature protection, over-current protection, or short-circuit protection occurs, the device sinks current from EN/nFAULT, pulling the pin down to alert the host (pin as output port).
4	SS	Soft-Start Pin. The capacitor between SS and GND pins will set the slew rate according to the application requirements.
5	ILIM	Current Limit Program Pin. A resistor between ILIM and GND will set the overload and short-circuit current limit levels. Do not float this pin.
6	OUT	Power Output Pin.

FUNCTIONAL BLOCK DIAGRAM

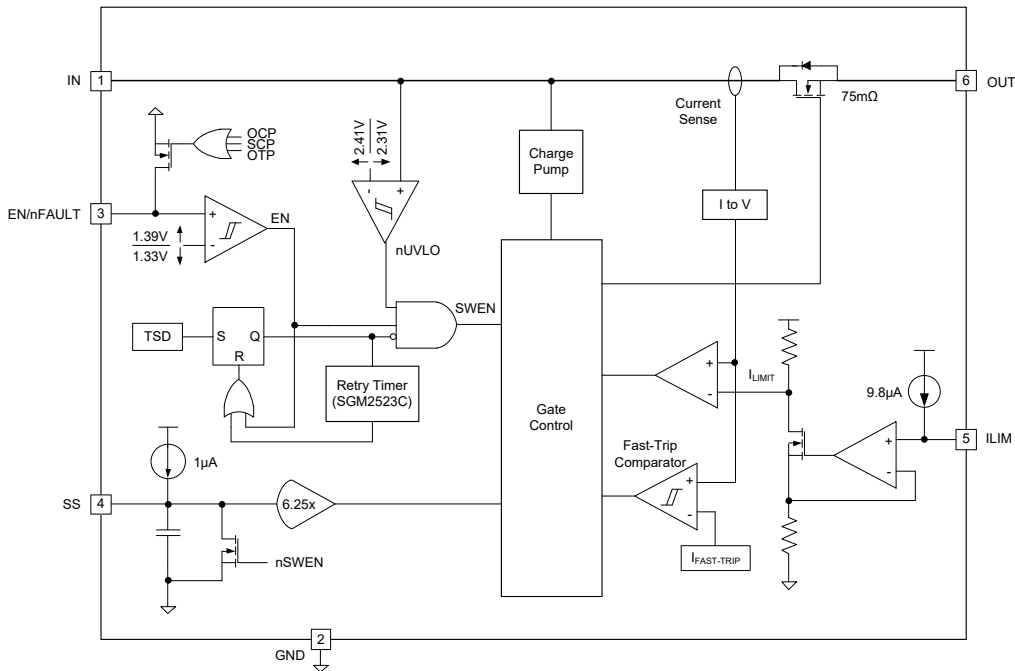

Figure 2. Functional Block Diagram

ELECTRICAL CHARACTERISTICS

($T_J = -40^{\circ}\text{C}$ to $+125^{\circ}\text{C}$, $V_{IN} = 2.6\text{V}$ to 22V , $V_{EN/nFAULT} = 2\text{V}$, $R_{ILIM} = 95.3\text{k}\Omega$, $C_{SS} = \text{Open}$, unless otherwise noted.)

PARAMETER	SYMBOL	CONDITIONS	MIN	TYP	MAX	UNITS
Supply Voltage and Internal Under-Voltage Lockout						
Operating Input Voltage	V_{IN}		2.6		22	V
UVLO Threshold Voltage, Rising	V_{UVR}		2.30	2.42	2.60	V
UVLO Hysteresis	V_{UVHYS}			100		mV
Supply Current, Enabled	I_{Q_ON}	$V_{EN/nFAULT} = 2\text{V}$, $V_{IN} = 12\text{V}$	100	150	230	μA
Supply Current, Disabled	I_{Q_OFF}	$V_{EN/nFAULT} = 0\text{V}$, $V_{IN} = 12\text{V}$		0.8	2	μA
Enable and Fault Flag (EN/nFAULT)						
EN/nFAULT Threshold Voltage, Rising	V_{ENR}		1.34	1.39	1.44	V
EN/nFAULT Threshold Voltage, Falling	V_{ENF}		1.28	1.33	1.38	V
EN/nFAULT Threshold Voltage to Reset Thermal Fault, Falling	V_{ENF_RST}				0.54	V
EN/nFAULT Input Leakage Current	$I_{EN/nFAULT}$	$V_{EN/nFAULT} = 0\text{V}$ to 18V	-100	0	100	nA
EN/nFAULT Pull-Down Resistance	$R_{EN/nFAULT}$	Device in fault condition, $V_{EN/nFAULT} = 0\text{V}$, $I_{EN/nFAULT} = 100\text{mA}$	15	29	60	Ω
Soft-Start: Output Ramp Control (SS)						
SS Charging Current	I_{SS}	$V_{SS} = 0\text{V}$	0.8	1	1.2	μA
SS to OUT Gain	$GAIN_{SS}$	$\Delta V_{OUT}/\Delta V_{SS}$	6.10	6.25	6.40	V/V
Current Limit Programming (ILIM)						
ILIM Pin Bias Current	I_{ILIM}		8.6	9.8	11	μA
Current Limit	I_{LIMIT}	$R_{ILIM} = 10\text{k}\Omega$		0.1		A
		$R_{ILIM} = 35.7\text{k}\Omega$	0.23	0.37	0.51	
		$R_{ILIM} = 45.3\text{k}\Omega$	0.31	0.48	0.64	
		$R_{ILIM} = 95.3\text{k}\Omega$, $T_J = +25^{\circ}\text{C}$	0.93	1	1.07	
		$R_{ILIM} = 95.3\text{k}\Omega$	0.90	1	1.10	
Fast-Trip Comparator Threshold	I_{FAST_TRIP}	R_{ILIM} in k Ω	$2 \times I_{LIMIT}$			A
ILIM Open Resistor Detect Threshold	V_{ILIM_OPEN}	V_{ILIM} rising, $R_{ILIM} = \text{Open}$, $V_{IN} = 5\text{V}$ to 22V	2.6	3.0	3.4	V
MOSFET-Power Switch						
FET On-Resistance	$R_{DS(ON)}$		40	75	125	m Ω
Pass FET Output (OUT)						
OUT Bias Current in Off State	I_{LKG_OUT}	$V_{EN/nFAULT} = 0\text{V}$, $V_{OUT} = 0\text{V}$ (Sourcing), $T_J = -40^{\circ}\text{C}$ to $+85^{\circ}\text{C}$	-0.5	0.1	0.5	μA
	I_{SINK_OUT}	$V_{EN/nFAULT} = 0\text{V}$, $V_{OUT} = 300\text{mV}$ (Sinking), $T_J = -40^{\circ}\text{C}$ to $+85^{\circ}\text{C}$	-0.5	0.2	0.5	
Thermal Shutdown (TSD)						
Thermal Shutdown Threshold, Rising	T_{TSD}			155		$^{\circ}\text{C}$
Thermal Shutdown Hysteresis	T_{TSDHYS}			20		$^{\circ}\text{C}$

TIMING REQUIREMENTS

($T_J = +25^\circ\text{C}$, $V_{IN} = 12\text{V}$, $V_{EN/nFAULT} = 2\text{V}$, $R_{ILIM} = 95.3\text{k}\Omega$, $C_{SS} = \text{Open}$, unless otherwise noted.)

PARAMETER	SYMBOL	CONDITIONS	MIN	TYP	MAX	UNITS
Enable and Fault Flag (EN/nFAULT)						
Turn-On Delay	t_{ON_DLY}	EN/nFAULT \uparrow to $V_{OUT} = 1\text{V}$, $C_{OUT} = 2.2\mu\text{F}$		75		μs
Turn-Off Delay	t_{OFF_DLY}	EN/nFAULT \downarrow to $V_{OUT} = 10.8\text{V}$, $C_{OUT} = 2.2\mu\text{F}$		90		μs
Soft-Start: Output Ramp Control (SS)						
Output Ramp Time	t_{SS}	EN/nFAULT \uparrow to $V_{OUT} = 11\text{V}$, with $C_{SS} = \text{open}$, $C_{OUT} = 2.2\mu\text{F}$	0.10	0.38	0.70	ms
		EN/nFAULT \uparrow to $V_{OUT} = 11\text{V}$, with $C_{SS} = 1.2\text{nF}$, $C_{OUT} = 2.2\mu\text{F}$	1.60	2.07	2.70	
Current Limit Programming (ILIM)						
Fast-Trip Comparator Delay	$t_{FAST_TRIP_DLY}$	$I_{OUT} > I_{FAST_TRIP}$		0.3		μs
Thermal Shutdown (TSD)						
Retry Delay after Thermal Shutdown Recovery, $T_J < [T_{TSD} - 20^\circ\text{C}]$	t_{TSD_DLY}	SGM2523C only, $V_{IN} = 12\text{V}$		700		ms
		SGM2523C only, $V_{IN} = 2.6\text{V}$		750		

PARAMETRIC MEASUREMENT INFORMATION

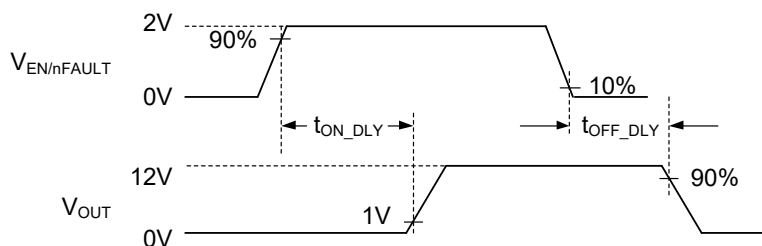

Figure 3. t_{ON_DLY} and t_{OFF_DLY} Waveforms

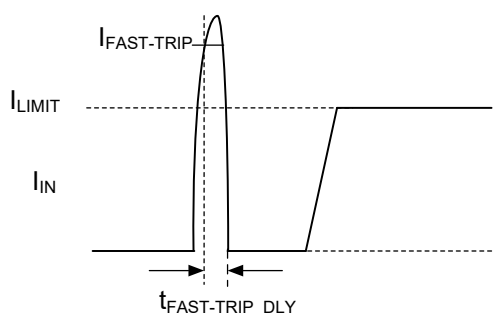
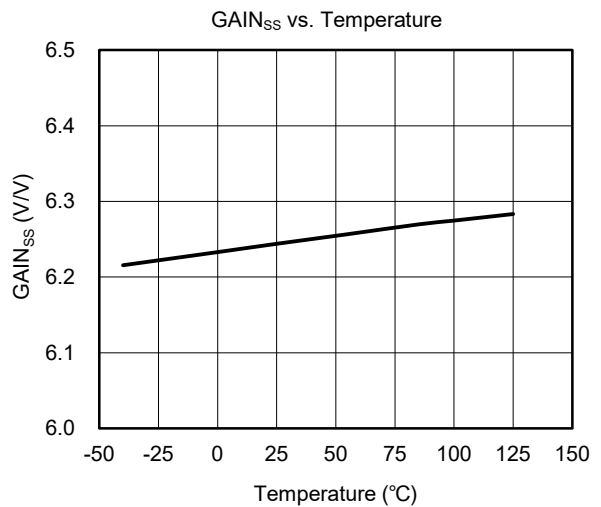
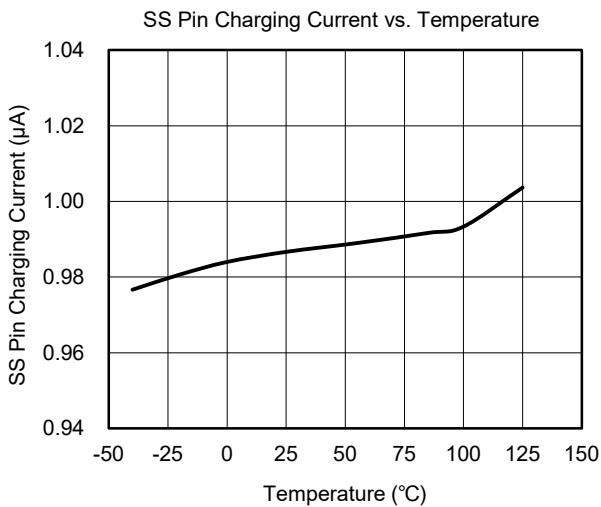
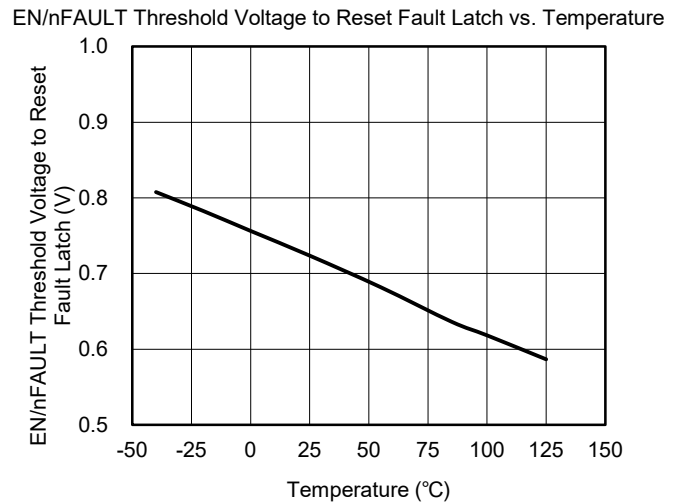
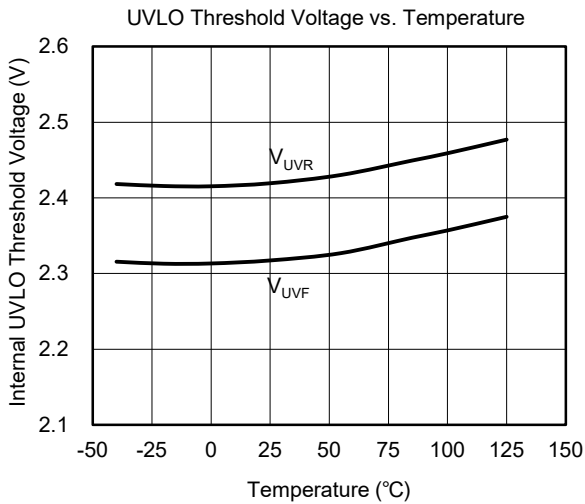
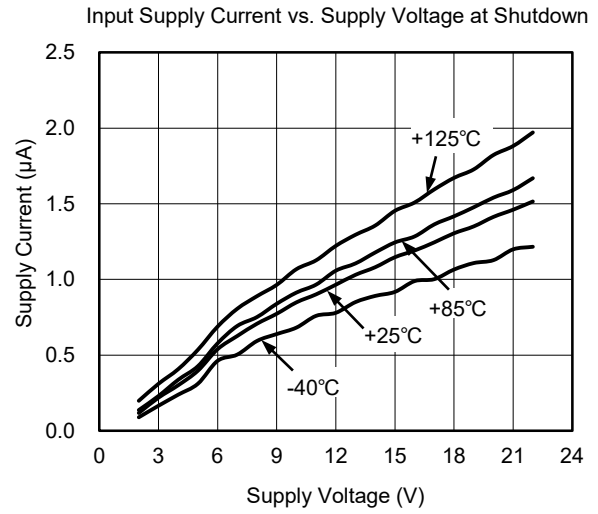
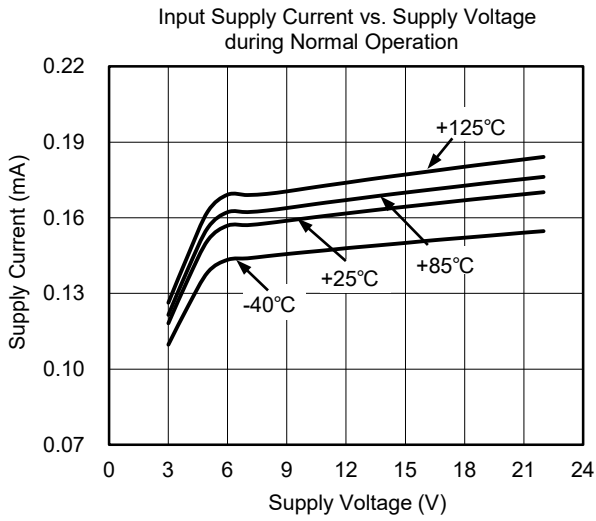

Figure 4. t_{OVP_DLY} Waveforms

TYPICAL PERFORMANCE CHARACTERISTICS

$T_J = +25^\circ\text{C}$, $V_{IN} = 2.6\text{V to } 22\text{V}$, $V_{EN/nFAULT} = 2\text{V}$, $R_{LIM} = 95.3\text{k}\Omega$, $C_{SS} = \text{Open}$, unless otherwise noted.



TYPICAL PERFORMANCE CHARACTERISTICS (continued)

$T_J = +25^\circ\text{C}$, $V_{IN} = 2.6\text{V to }22\text{V}$, $V_{EN/nFAULT} = 2\text{V}$, $R_{ILIM} = 95.3\text{k}\Omega$, $C_{SS} = \text{Open}$, unless otherwise noted.

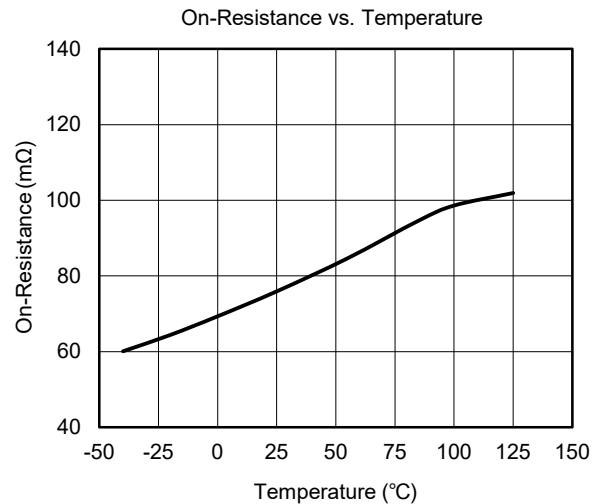
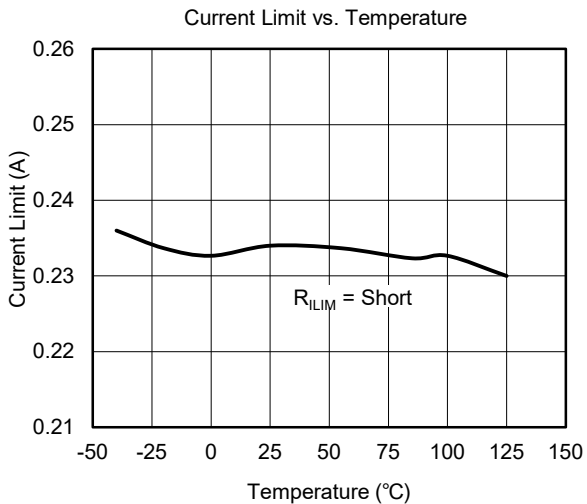
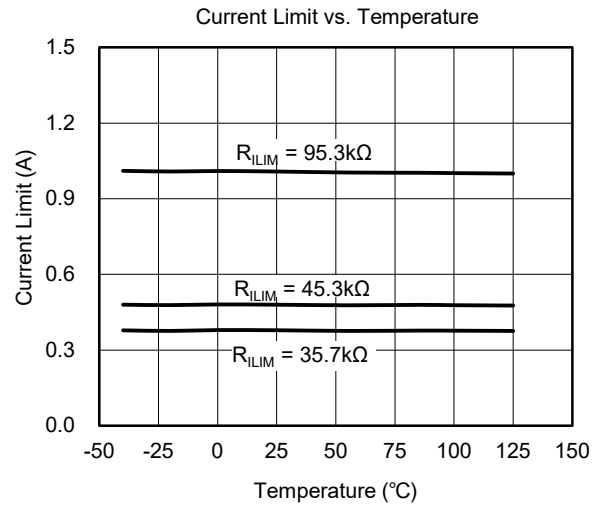
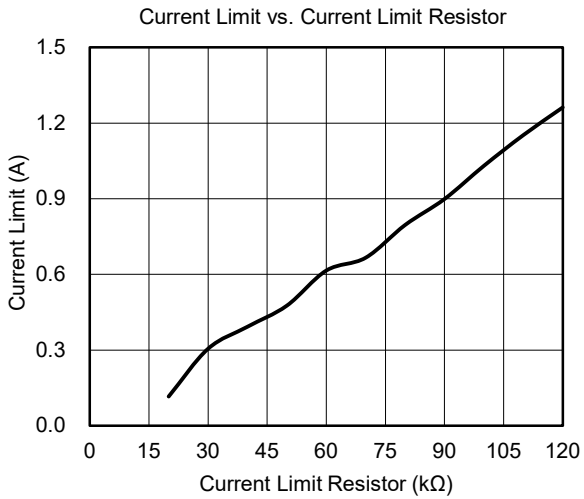
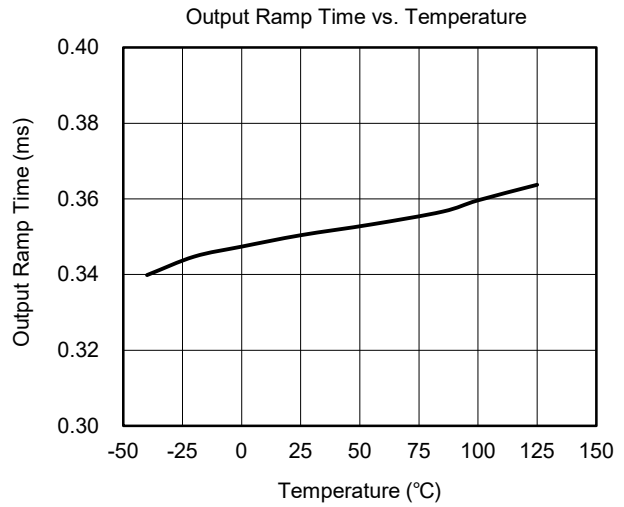
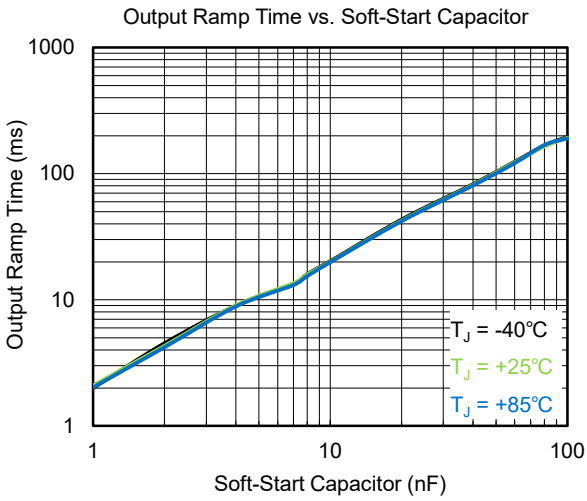

TYPICAL PERFORMANCE CHARACTERISTICS (continued)

$T_J = +25^\circ\text{C}$, $V_{IN} = 2.6\text{V to } 22\text{V}$, $V_{EN/nFAULT} = 2\text{V}$, $R_{ILIM} = 95.3\text{k}\Omega$, $C_{SS} = \text{Open}$, unless otherwise noted.

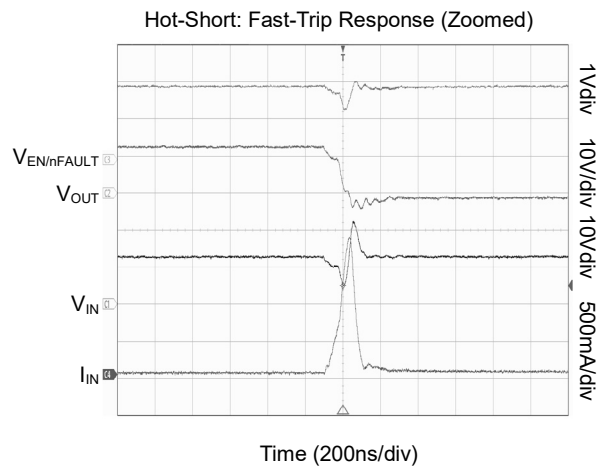
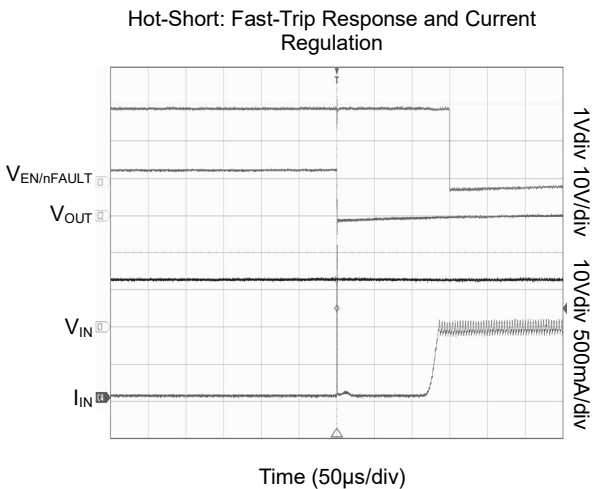
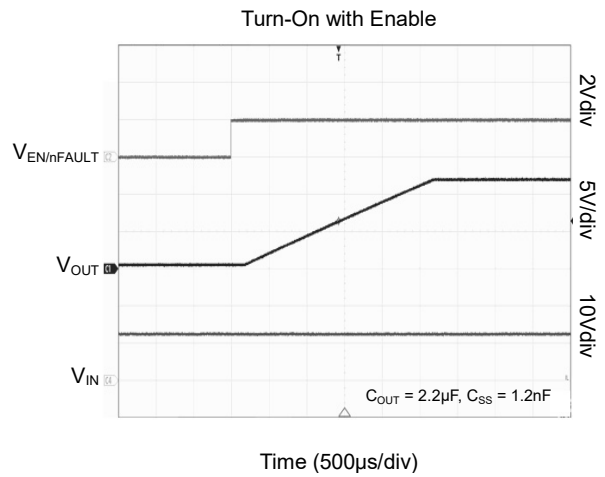
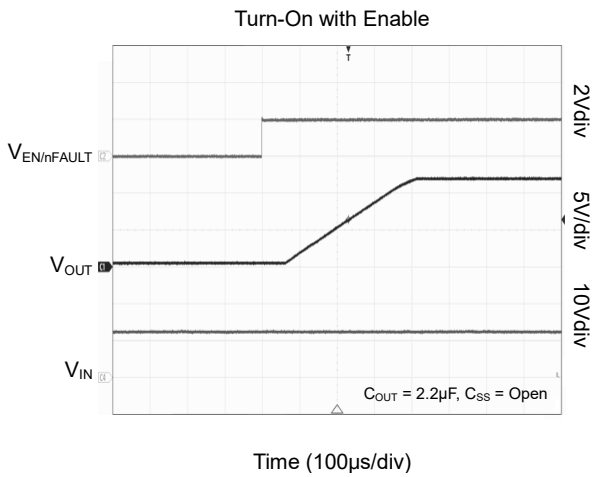
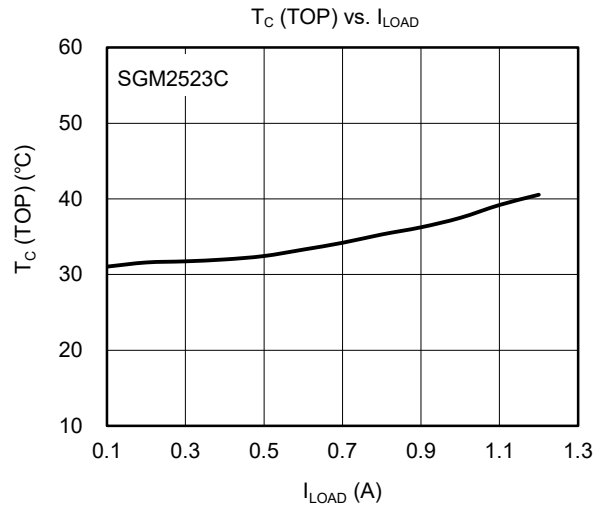
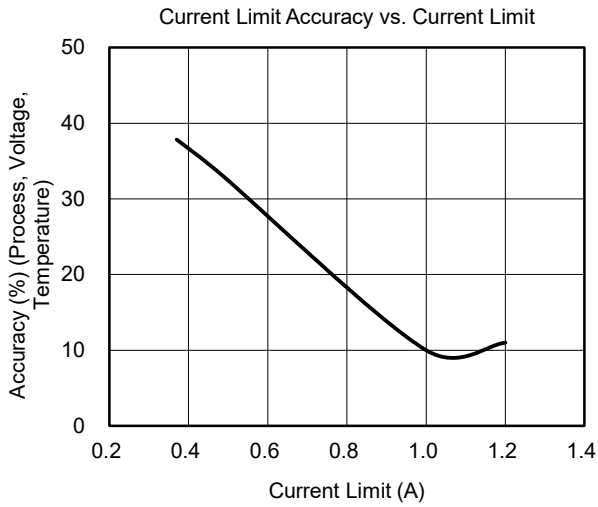

DETAILED DESCRIPTION

Overview

The SGM2523C/D are 6-pin, 2.6V to 22V eFuses with thermal shutdown. To reduce voltage drop for low voltage and high current rails, the device implements a low on-resistance N-MOSFET which reduces the dropout voltage across the device.

The configurable rise time of the device greatly reduces inrush current caused by large bulk load capacitances or hot-plug boards, thereby the power supply droop will be reduced or eliminated. The current limit threshold can be programmed between 0.1A and 1.2A through an external resistor.

When the output load exceeds the current limit threshold or a short-circuit event is present, the device limits the output current to a safe level by increasing the on-resistance of the power switch. Continuous heavy overloads and short-circuits that increase power dissipation of the switch can cause the junction temperature to rise, in which case thermal protection circuit will shut off the switch to prevent damage.

Enable and Adjusting Under-Voltage Lockout (UVLO)

The EN/nFAULT pin can control the state of the switch. Pulling the EN/nFAULT pin high enables the device. Logic high of V_{ENR} on the EN/nFAULT pin will enable the device and V_{ENF} will turn it off.

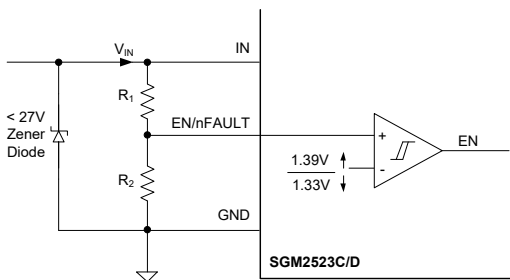

Figure 5. UVLO Thresholds Set by R₁ and R₂

As shown in Figure 5, the under-voltage locking threshold is programmed by an external resistor divider (R₁ and R₂) from the power input terminal to the EN/nFAULT terminal to the GND.

Once the input rails under-voltage, the N-MOSFET will be turned off quickly. If this function is not needed, connect the EN/nFAULT pin to the VIN rail to avoid it happens. Do not leave the EN/nFAULT pin floating.

The device implements the input UVLO and sets two UVLOs in combination with EN/nFAULT. If $V_{EN/nFAULT} < V_{ENF}$, the device is disabled and EN/nFAULT can set the V_{IN} rise threshold, so the device can set the section active voltage to avoid the input rail fluctuation.

When the switching voltage of the devices is more than 15V, a Zener diode of no more than 27V (> 0.5W) should be added to prevent the input voltage spike from damaging the device (as shown in Figure 5).

EN/nFAULT as Output Port

When any of over-current protection or over-temperature protection occurs, the device sinks current from EN/nFAULT, pulling the pin down to alert the host.

EN/nFAULT changes back to an input port, only after the device is released from a protection action.

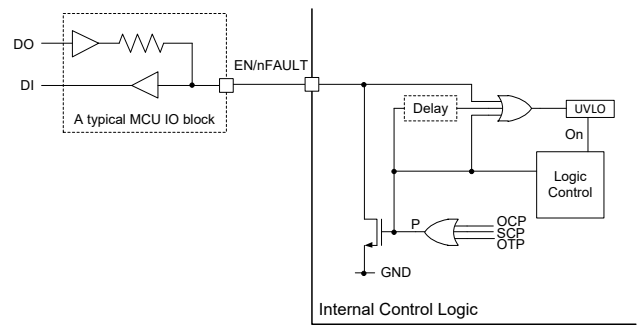

Figure 6. EN/nFAULT Application

Inrush Current Control

The SGM2523C/D are designed to control the inrush current when the devices are enable or power-on. The capacitor between SS and GND pins will set the slew rate according to the application requirements. An approximate formula for the relationship between C_{SS} and slew rate is shown in Equation 1:

$$I_{SS} = \frac{C_{SS}}{GAIN_{SS}} \times \frac{dV_{OUT}}{dt} \tag{1}$$

where:

$$I_{SS} = 1\mu A \text{ (TYP)}$$

$$dV_{OUT}/dt = \text{Target output slew rate}$$

$$GAIN_{SS} = \Delta V_{OUT}/\Delta V_{SS} = 6.25$$

$$C_{SS} \text{ (MAX)} \text{ must be less than } 1\mu F.$$

DETAILED DESCRIPTION (continued)

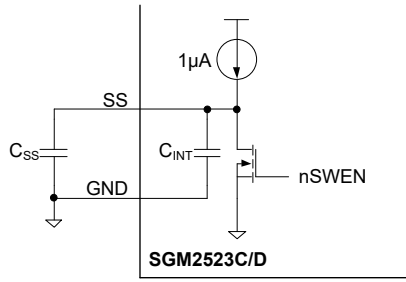

Figure 7. Output Ramp Time is Set by C_{SS}

Equation 2 shows how to calculate the total output ramp time (t_{SS}) when the output rises from 0V to V_{IN}:

$$t_{SS} = 16.1 \times 10^4 \times V_{IN} \times C_{SS} \quad (2)$$

where C_{SS} is in F.

Inrush current can be calculated by the following formula.

$$I_{INRUSH} = C_{OUT} \times \frac{V_{IN}}{t_{SS}} \quad (3)$$

Rise time can be calculated by multiplying the input voltage by the slew rate. If floating this pin, the slew rate of the output obtains a default value ~50V/ms (minimum t_{SS}).

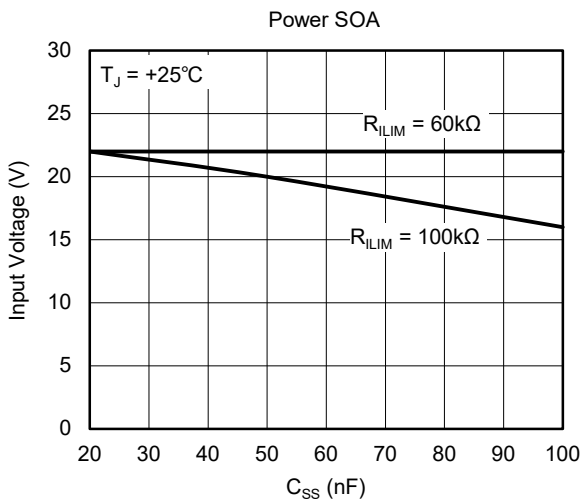

Figure 8. Power SOA

Over-Current and Short-Circuit Protections

The device limits current to the output in case of output shorts and overloads. If an event occurs, device goes

into current limit action, and the value of the current limit (I_{LIMIT}) is set by R_{ILIM} resistor:

$$I_{LIMIT} = 10.5 \times 10^{-3} \times R_{ILIM} \quad (4)$$

$$R_{ILIM} = \frac{I_{LIMIT}}{10.5 \times 10^{-3}} \quad (5)$$

where:

I_{LIMIT} is overload current limit in A.

R_{ILIM} is the current limit programming resistor in kΩ.

In addition to the general over-current protection, the SGM2523C/D also integrate fast-trip over-current protection with quicker response time.

Overload Protection

Once an overload occurs, the internal current limit amplifier limits the output current to the predetermined value by increasing the on-resistance of the power switch.

During current limit regulation, the output voltage drops, resulting in increased power consumption. The SGM2523C/D allow ILIM pin floating operation. If ILIM pin is floating, the current limit will be set as fixed 0.2A internally.

When the over-current limit condition lasts more than 2ms, the SGM2523C enters the hiccup mode with 2ms on time and 700ms off time, whereas the SGM2523D enters shutdown mode.

Short-Circuit Protection

A transient short-circuit occurs, due to the limited bandwidth of the current limit amplifier, which cannot respond quickly to this event. The SGM2523C/D contain a fast-trip comparator with a threshold (I_{FAST-TRIP}). If I_{OUT} > I_{FAST-TRIP}, the comparator turns off the N-MOSFET and terminates the short-circuit peak current across the N-MOSFET rapidly. The fast-trip threshold is 2 times the overload current limit. The fast-trip comparator can terminate the transient short-circuit peak current, and then the current limit function limits the output current to I_{LIMIT}.

$$I_{FAST-TRIP} = 2 \times I_{LIMIT} \quad (6)$$

where:

I_{FAST-TRIP} is the fast-trip current limit threshold, which is measured in A.

DETAILED DESCRIPTION (continued)

After the fast-trip is triggered, the fast-trip circuit will first make the FET turn off for several microseconds, and then the device enters the current limit start-up period, where the output current is limited to I_{LIMIT} . After this period, the behavior of the device is the same as that of over-current.

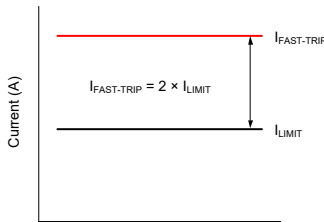

Figure 9. Over-Current Protection Levels

Start-Up and I_{OUT}

During the power-up, the I_{OUT} is equal to the smaller one of Equation 3 and Equation 4.

IN, OUT and GND

To limit the voltage drop on the input supply caused by transient inrush current when the switch turns on into a discharged load capacitor, a capacitor needs to be placed between IN and GND pins. Use a bypass capacitor as close as possible between IN and GND pins. Due to the integrated body diode in the N-MOSFET, it is highly recommended that C_{IN} should be greater than C_{OUT} . When the system power supply is removed, if C_{OUT} is greater than C_{IN} , it will cause V_{OUT} to exceed V_{IN} .

This will result in current flow through the body diode from V_{OUT} to V_{IN} . A C_{IN} to C_{OUT} ratio of 10 to 1 is recommended for minimizing V_{IN} dip caused by inrush currents during start-up. V_{OUT} in the on state can be calculated as Equation 7:

$$V_{OUT} = V_{IN} - (R_{DS(ON)} \times I_{OUT}) \quad (7)$$

where $R_{DS(ON)}$ is the resistance of the FET during on-state.

GND terminal is the ground pin, which is the most negative voltage in the chip. GND is the negative terminal of all other terminals unless otherwise specified.

Thermal Shutdown

Thermal shutdown protects the device from excessive temperature. Once the device is shut down due to TSD fault, it will either stay latch-off (SGM2523D) or restart automatically after T_J drops below $[T_{TSD} - 20\text{ }^\circ\text{C}]$ (SGM2523C). When over-temperature protection is triggered, the EN/nFAULT pin is pulled low to indicate the fault signal.

Shutdown Control

By keeping the EN/nFAULT pin below its V_{ENF} threshold, the internal FET and load current can be turned off remotely.

Operational Overview

The device function is shown in Table 1.

Table 1. Device Functions

Device	SGM2523C and SGM2523D
Start-Up	Inrush ramp controlled by SS pin via an external capacitor.
	Limit inrush current to I_{LIMIT} level.
	If $T_J > T_{TSD}$, device shuts off.
Over-Current Response	Current is limited to I_{LIMIT} level.
	Power dissipation increases as $V_{IN} - V_{OUT}$ grows.
	$T_J > T_{TSD}$, the device is turned off.
	SGM2523C will attempt restart t_{TSD_DLY} ms after $T_J < [T_{TSD} - 20\text{ }^\circ\text{C}]$. SGM2523D remains off.
Short-Circuit Response	Fast shut off when $I_{LOAD} > I_{FAST-TRIP}$.
	Quick restart and current limited to I_{LIMIT} , follows standard start-up cycle.

The SGM2523C/D provide a complete set of protection functions for overload or inrush current. The wide operating voltage range (2.6V to 22V) is specifically designed for many popular DC buses, and the maximum load current of 1.2A can meet the power delivery requirements of many devices.

APPLICATION INFORMATION

Protection and Current Limit for AC/DC Power Supplies

In many small household appliances, portable devices, consumer products and other application scenarios, the primary-side power supplies and adapter are dominant. These power supplies generally have a rated power of 5W - 30W, which is generally characterized by high efficiency, low cost and few components. However, there are also the following shortcomings:

- No secondary-side protection which can stop short-circuit and other key faults immediately.
- Cannot provide precision current limit for overload transients.
- Poor ability to regulate the output voltage during sudden fluctuation of the AC input voltage, when the output over-voltage condition is triggered.

Therefore, accurate current sensing and overload protection are required for the secondary side output port in the above applications. This requires the use of precision operational amplifiers for additional circuit implementation. It adds complexity to the solution and leads to a loss of sensing. The SGM2523C/D adopting N-MOSFET with low on-resistance is a simple and efficient solution. The typical application circuit of SGM2523C/D is shown in Figure 10.

During short-circuit fault, the internal fast comparator shuts down the FET within 0.3μs after the input current increases rapidly and exceeds $I_{FAST-TRIP}$ which is set by the external R_{ILIM} resistor.

Furthermore, the SGM2523C/D provide inrush current limit during the output ramp up procedure.

Precision Current Limit in Intrinsic Safety Applications

The safe operation of electrical and electronic equipment in dangerous area environment has a more and more urgent requirements for intensive safety (IS). IS requires that the total energy available during equipment operation is not enough to ignite the surrounding explosive environment by means of electric sparks or heat transfer. This requires precision current limits to ensure that the set current limits are not exceeded over a wide operating temperature range and variable environmental conditions. Applications such as gas analyzers, medical devices, portal industrial equipment, etc., need to meet these importance safety standards. As a simple over-voltage and over-load protection solution, SGM2523C/D are applicable to each power rail inside the system application. The typical implementation circuit of SGM2523C/D is shown in Figure 11.

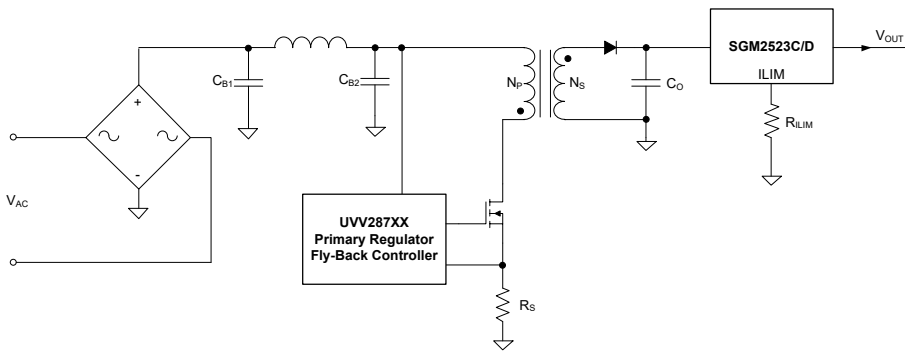

Figure 10. Current Limit and Protection for AC/DC Power Supplies

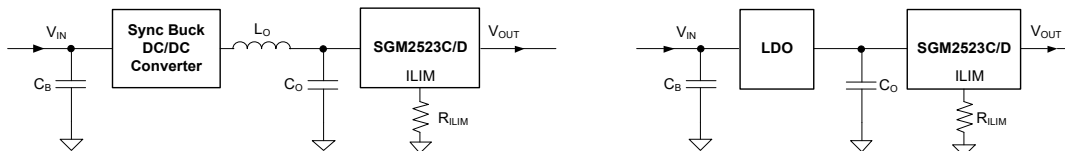

Figure 11. Precision Current Limit and Protection of Internal Rails

APPLICATION INFORMATION (continued)

Smart Load Switch

The smart load switch is a series of MOSFETs used to switch the load (resistance or inductance). It also provides protection in case of failure. Figure 12 shows a typical discrete implementation of load switch, which requires more components and more complex circuits to achieve fault protection. The SGM2523C/D can be used as a load switch for the applications whose operating range is from 2.6V to 22V. Programmable

current limits, programmable soft-start, over-temperature protection, fault flag and under-voltage lockout are provided in the SGM2523C/D.

Used as a load switch, Figure 12 shows a typical implementation of SGM2523C/D, which is used for driving a solenoid and fan control. Freewheeling diode is recommended for the highly inductive load.

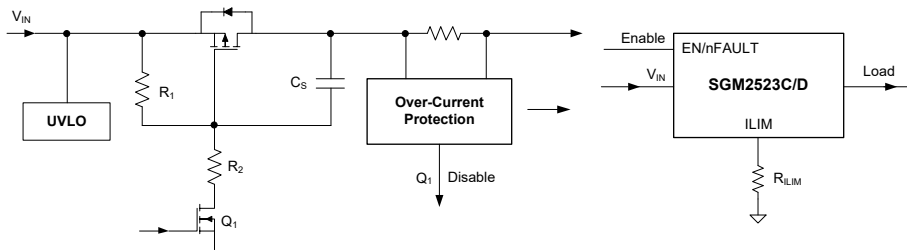

Figure 12. Smart Load Switch Implementation

REVISION HISTORY

NOTE: Page numbers for previous revisions may differ from page numbers in the current version.

NOVEMBER 2022 – REV.A to REV.A.1	Page
Updated Detailed Description section	9, 10, 11
Changes from Original (MARCH 2021) to REV.A	Page
Changed from product preview to production data.....	All

PACKAGE OUTLINE DIMENSIONS

SOT-23-6

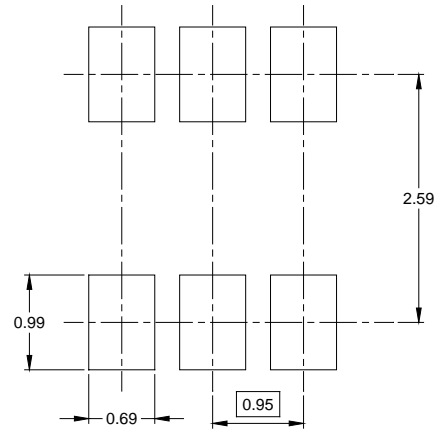
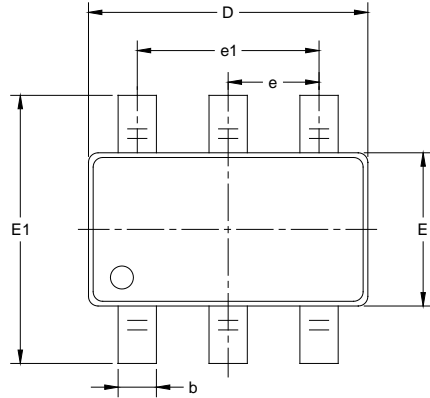

RECOMMENDED LAND PATTERN (Unit: mm)

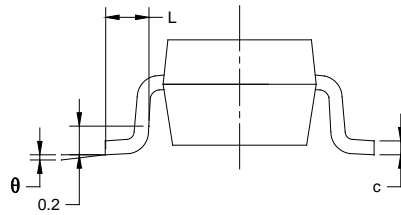
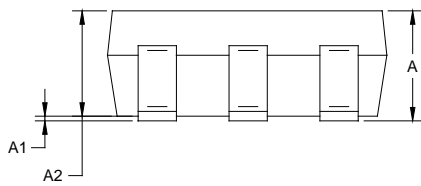

Symbol	Dimensions In Millimeters		Dimensions In Inches	
	MIN	MAX	MIN	MAX
A	1.050	1.250	0.041	0.049
A1	0.000	0.100	0.000	0.004
A2	1.050	1.150	0.041	0.045
b	0.300	0.500	0.012	0.020
c	0.100	0.200	0.004	0.008
D	2.820	3.020	0.111	0.119
E	1.500	1.700	0.059	0.067
E1	2.650	2.950	0.104	0.116
e	0.950 BSC		0.037 BSC	
e1	1.900 BSC		0.075 BSC	
L	0.300	0.600	0.012	0.024
θ	0°	8°	0°	8°

NOTES:

1. Body dimensions do not include mode flash or protrusion.
2. This drawing is subject to change without notice.

TAPE AND REEL INFORMATION

REEL DIMENSIONS

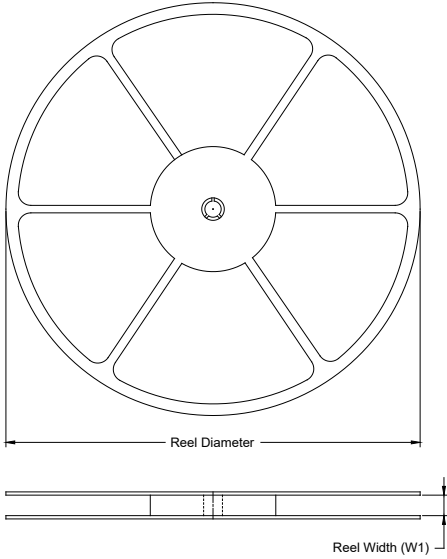

TAPE DIMENSIONS



NOTE: The picture is only for reference. Please make the object as the standard.

KEY PARAMETER LIST OF TAPE AND REEL

Package Type	Reel Diameter	Reel Width W1 (mm)	A0 (mm)	B0 (mm)	K0 (mm)	P0 (mm)	P1 (mm)	P2 (mm)	W (mm)	Pin1 Quadrant
SOT-23-6	7"	9.5	3.23	3.17	1.37	4.0	4.0	2.0	8.0	Q3

000001

PACKAGE INFORMATION

CARTON BOX DIMENSIONS



NOTE: The picture is only for reference. Please make the object as the standard.

KEY PARAMETER LIST OF CARTON BOX

Reel Type	Length (mm)	Width (mm)	Height (mm)	Pizza/Carton
7" (Option)	368	227	224	8
7"	442	410	224	18

DD0002