

### GENERAL DESCRIPTION

The SGM2567S is an ultra-low on-resistance, integrated N-MOSFET, single-channel load switch. The device operates over a wide input voltage range of 1.8V to 5.5V. It has the ability to drive up to 3.4A continuous current.

The device contains an 11mΩ low R<sub>ON</sub> N-MOSFET controlled by the ON pin. During power-up, a smart pull-down resistor is used to avoid the ON pin floating. Once the ON pin reaches a high voltage (> V<sub>IH</sub>), the smart pull-down resistor is disconnected, which reduces the standby current and power loss. The small package and low R<sub>ON</sub> make the device very suitable for space limited, battery powered applications.

The SGM2567S is available in a Green WLCSP-1.5×0.95-6B package.

### FEATURES

- **Input Voltage Range: 1.8V to 5.5V**
- **Low On-Resistance**
  - ◆ R<sub>ON</sub> = 11mΩ at V<sub>IN</sub> = 5V
  - ◆ R<sub>ON</sub> = 11mΩ at V<sub>IN</sub> = 3.3V
  - ◆ R<sub>ON</sub> = 12mΩ at V<sub>IN</sub> = 1.8V
- **Low Shutdown Current: 0.02μA (TYP)**
- **Low Threshold 1.8V GPIO Control Input**
- **Quick Output Discharge**
- **Internal Fixed Slew Rate to Avoid Inrush Current**
- **Over-Temperature Protection**
- **Available in a Green WLCSP-1.5×0.95-6B Package**

### APPLICATIONS

Smartphone  
 Notebook and Tablet Computer  
 Solid State Drive (SSD)  
 Set-Top Box and Residential Gateway  
 Portable and Handheld Device

### TYPICAL APPLICATION

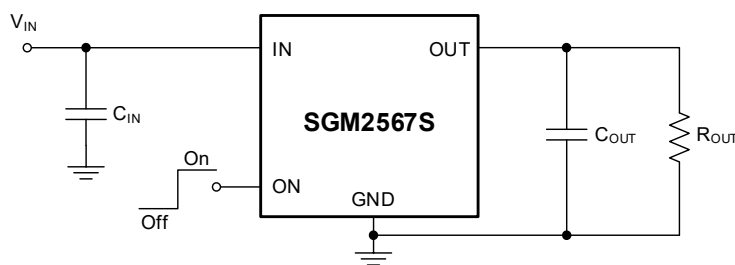

Figure 1. Typical Application Circuit

## PACKAGE/ORDERING INFORMATION

MODEL	PACKAGE DESCRIPTION	SPECIFIED TEMPERATURE RANGE	ORDERING NUMBER	PACKAGE MARKING	PACKING OPTION
SGM2567S	WLCSP-1.5×0.95-6B	-40°C to +125°C	SGM2567SXG/TR	XXX 08S	Tape and Reel, 4000

## MARKING INFORMATION

NOTE: XXX = Date Code and Trace Code.

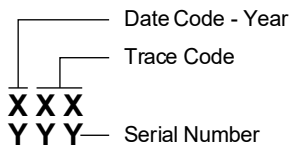

Green (RoHS & HSF): SG Micro Corp defines "Green" to mean Pb-Free (RoHS compatible) and free of halogen substances. If you have additional comments or questions, please contact your SGMICRO representative directly.

## ABSOLUTE MAXIMUM RATINGS

Input Voltage Range, V <sub>IN</sub> .....	-0.3V to 6V
Output Voltage Range, V <sub>OUT</sub> .....	-0.3V to 6V
ON Pin Voltage Range, V <sub>ON</sub> .....	-0.3V to 6V
Maximum Continuous Switch Current, I <sub>MAX</sub> .....	3.4A
Package Thermal Resistance	
WLCSP-1.5×0.95-6B, θ <sub>JA</sub> .....	107.5°C/W
Junction Temperature .....	+150°C
Storage Temperature Range .....	-65°C to +150°C
Lead Temperature (Soldering, 10s) .....	+260°C
ESD Susceptibility	
HBM .....	4000V
CDM .....	1000V

## RECOMMENDED OPERATING CONDITIONS

Input Voltage Range, V <sub>IN</sub> .....	1.8V to 5.5V
Output Voltage Range, V <sub>OUT</sub> .....	0V to 5.5V
High-Level ON Pin Voltage, V <sub>IH</sub> .....	1.2V to 5.5V
Low-Level ON Pin Voltage, V <sub>IL</sub> .....	0V to 0.35V
Input Capacitance, C <sub>IN</sub> .....	1μF
Operating Junction Temperature Range .....	-40°C to +125°C

## OVERSTRESS CAUTION

Stresses beyond those listed in Absolute Maximum Ratings may cause permanent damage to the device. Exposure to absolute maximum rating conditions for extended periods may affect reliability. Functional operation of the device at any conditions beyond those indicated in the Recommended Operating Conditions section is not implied.

## ESD SENSITIVITY CAUTION

This integrated circuit can be damaged if ESD protections are not considered carefully. SGMICRO recommends that all integrated circuits be handled with appropriate precautions. Failure to observe proper handling and installation procedures can cause damage. ESD damage can range from subtle performance degradation to complete device failure. Precision integrated circuits may be more susceptible to damage because even small parametric changes could cause the device not to meet the published specifications.

## DISCLAIMER

SG Micro Corp reserves the right to make any change in circuit design, or specifications without prior notice.

**PIN CONFIGURATION**

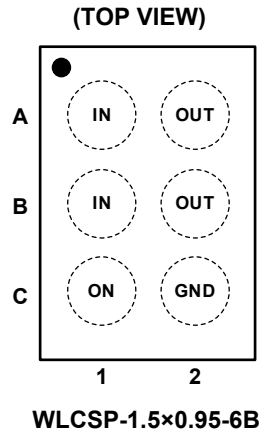

**PIN DESCRIPTION**

PIN	NAME	FUNCTION
A1, B1	IN	Switch Input. It is recommended to use a bypass capacitor (ceramic) to ground.
A2, B2	OUT	Switch Output.
C1	ON	Switch Control Input. Logic low turns off the power switch and logic high turns on the power switch.
C2	GND	Ground.

**FUNCTIONAL BLOCK DIAGRAM**

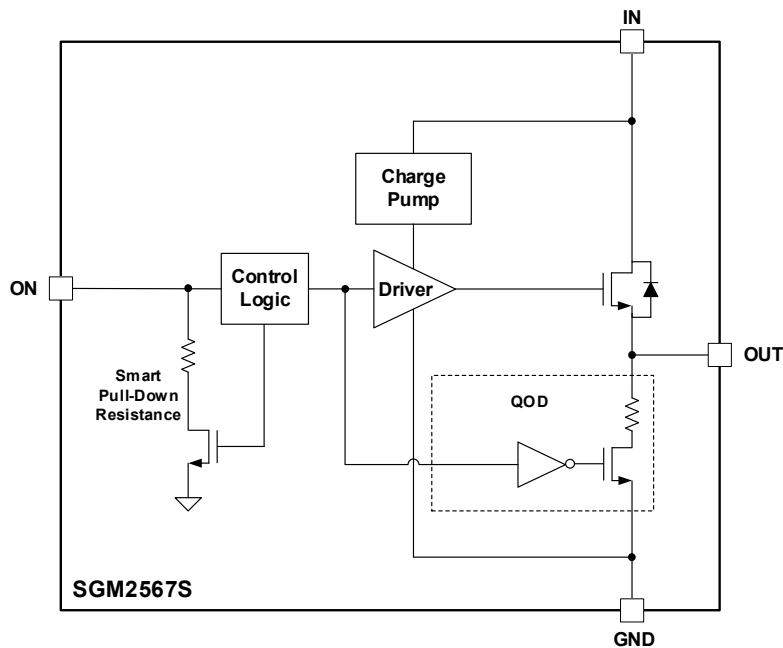

## ELECTRICAL CHARACTERISTICS

(T<sub>J</sub> = -40°C to +125°C, V<sub>IN</sub> = 1.8V to 5.5V, C<sub>IN</sub> = 1μF, C<sub>OUT</sub> = 0.1μF, typical values are at T<sub>J</sub> = +25°C, unless otherwise noted.)

PARAMETER	SYMBOL	CONDITIONS	MIN	TYP	MAX	UNITS
Input Voltage Range	V <sub>IN</sub>		1.8		5.5	V
Under-Voltage Lockout Voltage	V <sub>UVLO</sub>			1.7	1.75	V
Quiescent Current	I <sub>Q</sub>	V <sub>IN</sub> = 5.5V, V <sub>ON</sub> = 1.2V, I <sub>OUT</sub> = 0A		25	38	μA
		V <sub>IN</sub> = 3.3V, V <sub>ON</sub> = 1.2V, I <sub>OUT</sub> = 0A		18	29	
		V <sub>IN</sub> = 1.8V, V <sub>ON</sub> = 1.2V, I <sub>OUT</sub> = 0A		14	22	
Shutdown Current	I <sub>SD</sub>	V <sub>IN</sub> = 5.5V, V <sub>ON</sub> = 0V	T <sub>J</sub> = -40°C to +85°C	0.02	2.6	μA
			T <sub>J</sub> = -40°C to +125°C	0.02	16	
Supply Leakage Current in Shutdown Mode	I <sub>LEAKAGE</sub>	V <sub>IN</sub> = 5.5V, V <sub>ON</sub> = 0V, V <sub>OUT</sub> = 0V	T <sub>J</sub> = -40°C to +85°C	0.02	2.6	μA
			T <sub>J</sub> = -40°C to +125°C	0.02	16	
On-Resistance	R <sub>ON</sub>	V <sub>IN</sub> = 5V, V <sub>ON</sub> = 2V, I <sub>OUT</sub> = -200mA	T <sub>J</sub> = -40°C to +85°C	11	20	mΩ
			T <sub>J</sub> = -40°C to +125°C	11	23	mΩ
		V <sub>IN</sub> = 3.3V, V <sub>ON</sub> = 2V, I <sub>OUT</sub> = -200mA	T <sub>J</sub> = -40°C to +85°C	11	20	mΩ
			T <sub>J</sub> = -40°C to +125°C	11	23	mΩ
		V <sub>IN</sub> = 1.8V, V <sub>ON</sub> = 2V, I <sub>OUT</sub> = -200mA	T <sub>J</sub> = -40°C to +85°C	12	22	mΩ
			T <sub>J</sub> = -40°C to +125°C	12	26	mΩ
ON Pin Hysteresis	V <sub>HYS</sub>	V <sub>IN</sub> = 5.5V		58		mV
		V <sub>IN</sub> = 3.3V		58		
		V <sub>IN</sub> = 1.8V		51		
ON Pin Leakage Current	I <sub>ON</sub>	V <sub>ON</sub> = 5.5V		2	240	nA
Output Pull-Down Resistance	R <sub>PD</sub>	V <sub>ON</sub> = 0V, I <sub>OUT</sub> = 2mA		210	330	Ω
Smart Pull-Down Resistance	R <sub>PD_ON</sub>	Disabled		1000	1600	kΩ
ON Pin Input Low Voltage	V <sub>IL</sub>	T <sub>J</sub> = -40°C to +85°C			0.4	V
		T <sub>J</sub> = -40°C to +125°C			0.35	
ON Pin Input High Voltage	V <sub>IH</sub>	T <sub>J</sub> = -40°C to +125°C	1.2			
Current Limit	I <sub>LIM</sub>	C <sub>LOAD</sub> = 1μF	3.5	5.75		A
Over-Temperature Shutdown Threshold	T <sub>SD</sub>			155		°C
Over-Temperature Shutdown Hysteresis	T <sub>HYS</sub>			25		°C

**SWITCHING CHARACTERISTICS**

(C<sub>IN</sub> = 1μF, C<sub>OUT</sub> = 0.1μF, R<sub>OUT</sub> = 10Ω, typical values are at T<sub>J</sub> = +25°C, unless otherwise noted.)

PARAMETER	SYMBOL	CONDITIONS	MIN	TYP	MAX	UNITS
<b>V<sub>IN</sub> = 5.5V, T<sub>J</sub> = +25°C, unless otherwise noted.</b>						
Turn-On Time	t <sub>ON</sub>	Figure 2 and Figure 3		2000		μs
Turn-Off Time	t <sub>OFF</sub>			1.5		
V <sub>OUT</sub> Rise Time	t <sub>R</sub>			2700		
V <sub>OUT</sub> Fall Time	t <sub>F</sub>			2.6		
Delay Time	t <sub>D</sub>			900		
<b>V<sub>IN</sub> = 3.3V, T<sub>J</sub> = +25°C, unless otherwise noted.</b>						
Turn-On Time	t <sub>ON</sub>	Figure 2 and Figure 3		2100		μs
Turn-Off Time	t <sub>OFF</sub>			2		
V <sub>OUT</sub> Rise Time	t <sub>R</sub>			2100		
V <sub>OUT</sub> Fall Time	t <sub>F</sub>			2.6		
Delay Time	t <sub>D</sub>			1200		
<b>V<sub>IN</sub> = 1.8V, T<sub>J</sub> = +25°C, unless otherwise noted.</b>						
Turn-On Time	t <sub>ON</sub>	Figure 2 and Figure 3		2000		μs
Turn-Off Time	t <sub>OFF</sub>			3.5		
V <sub>OUT</sub> Rise Time	t <sub>R</sub>			1500		
V <sub>OUT</sub> Fall Time	t <sub>F</sub>			2.6		
Delay Time	t <sub>D</sub>			1400		

**PARAMETER MEASUREMENT INFORMATION**

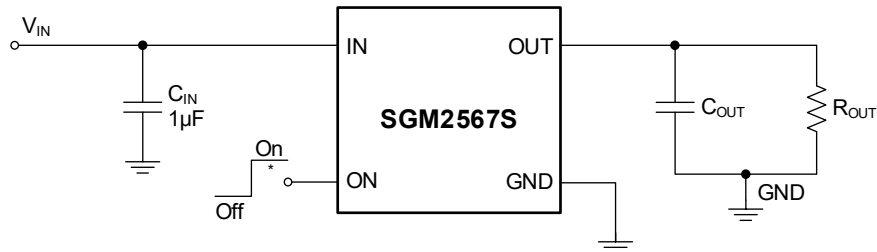

\*: Rise and fall times of the control signal are 100ns.

Figure 2. Test Circuit

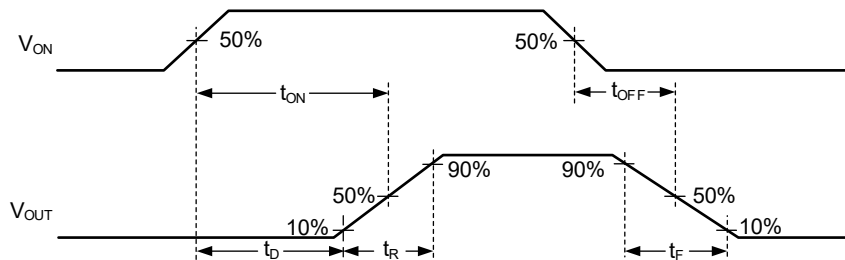
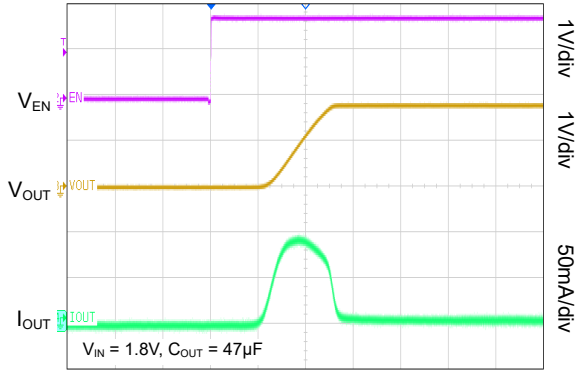

Figure 3. Timing Waveforms

TYPICAL PERFORMANCE CHARACTERISTICS

T<sub>J</sub> = +25°C, R<sub>OUT</sub> = 330Ω, unless otherwise noted.

Turn-On Time and Inrush Current



Time (1ms/div)

Turn-On Time and Inrush Current

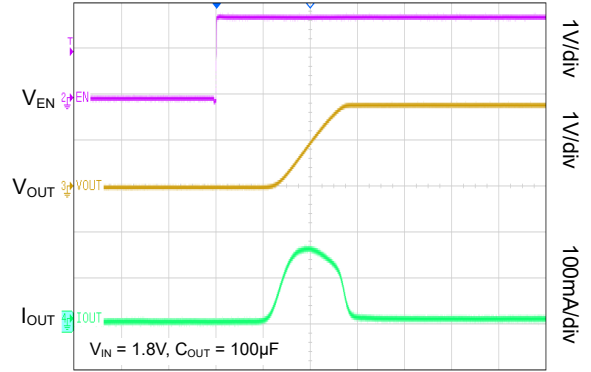

Time (1ms/div)

Turn-On Time and Inrush Current

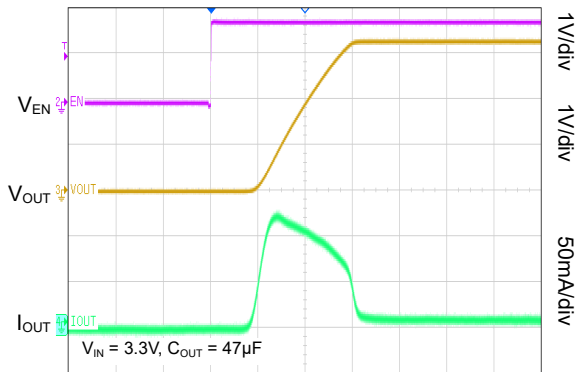

Time (1ms/div)

Turn-On Time and Inrush Current

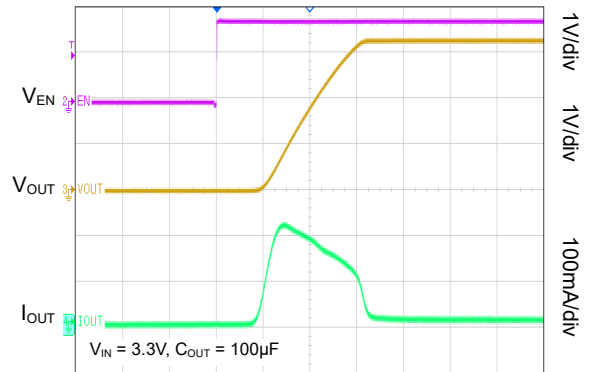

Time (1ms/div)

Turn-On Time and Inrush Current

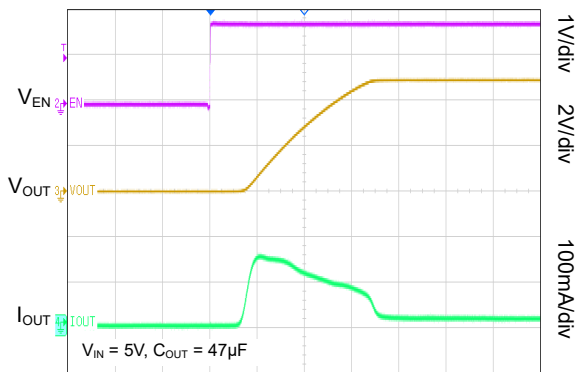

Time (1ms/div)

Turn-On Time and Inrush Current

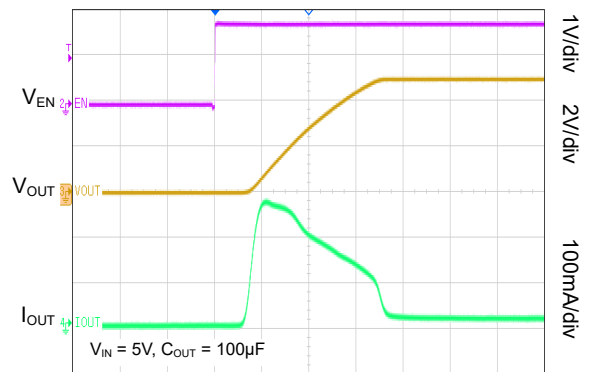

Time (1ms/div)

TYPICAL PERFORMANCE CHARACTERISTICS (continued)

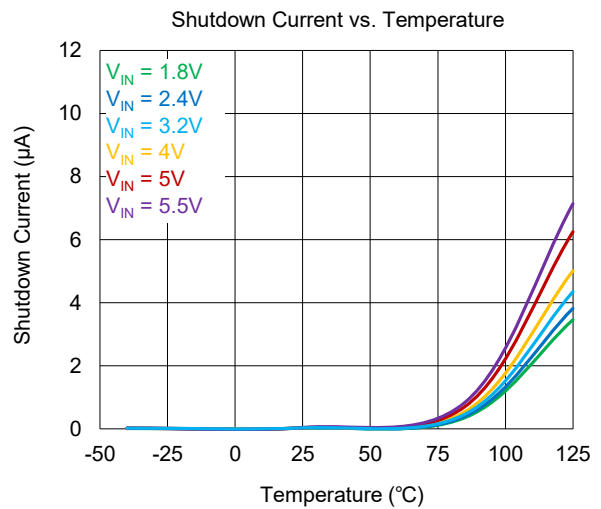
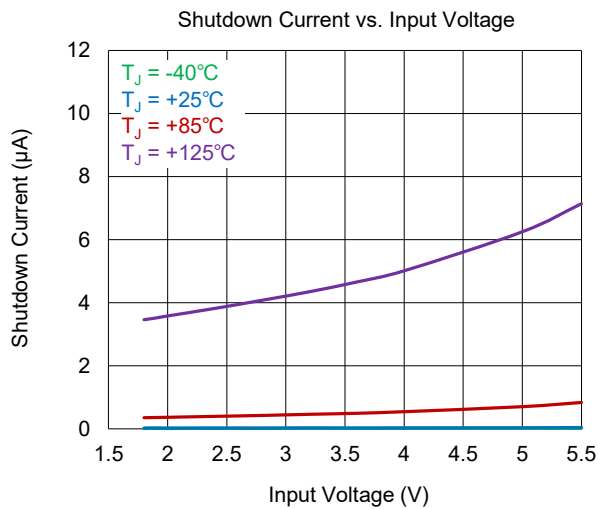
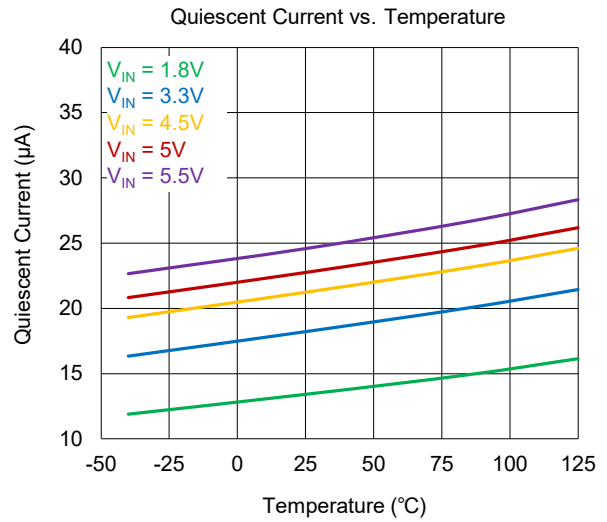
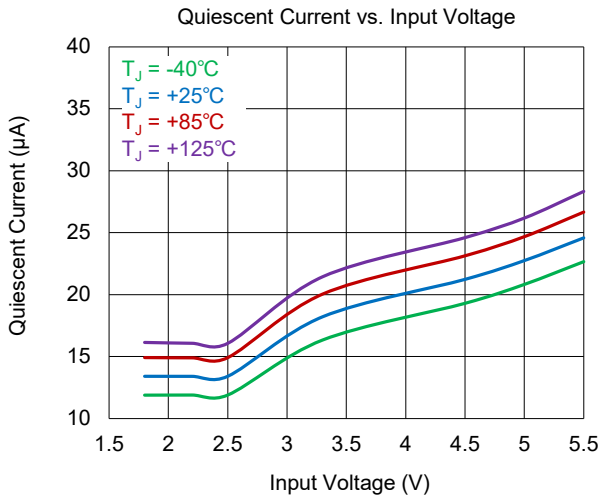
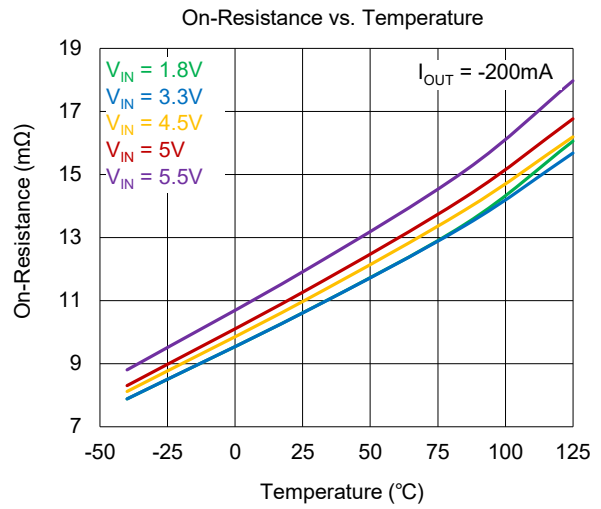
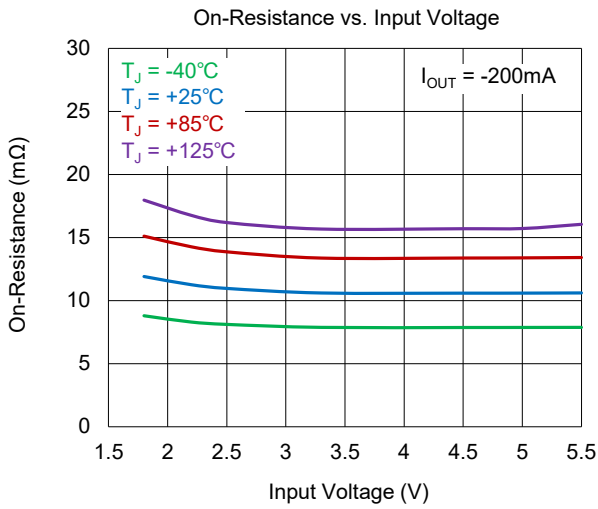

TYPICAL PERFORMANCE CHARACTERISTICS (continued)

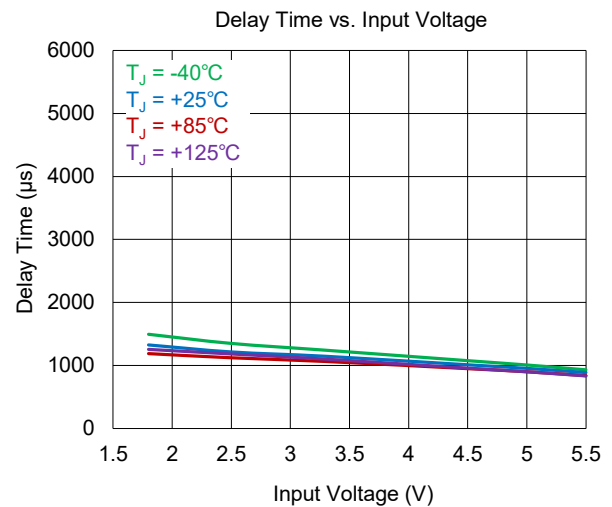
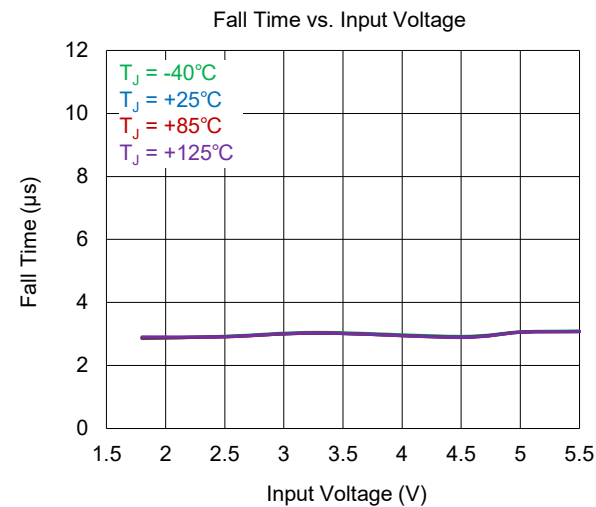
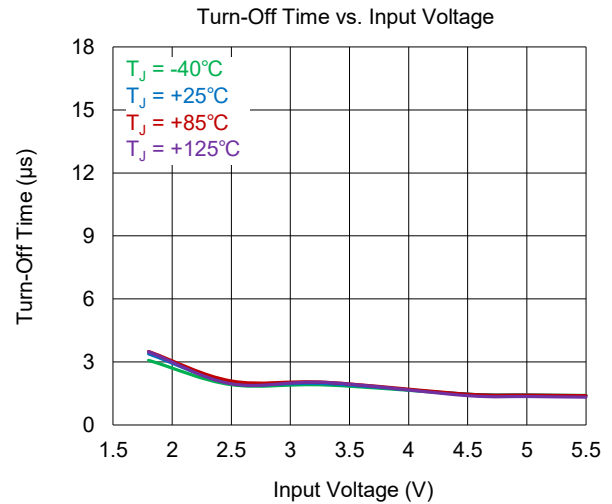
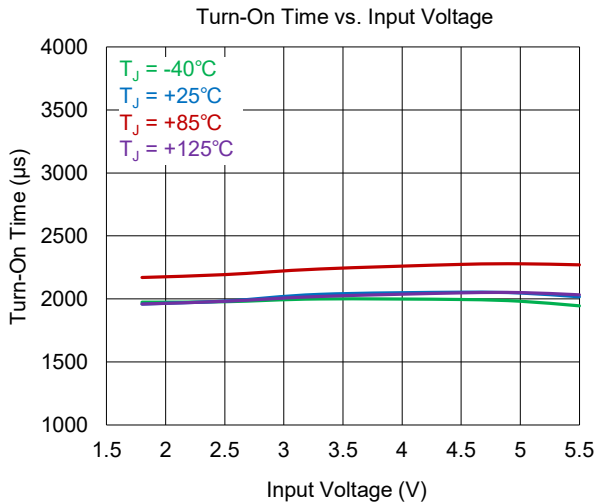
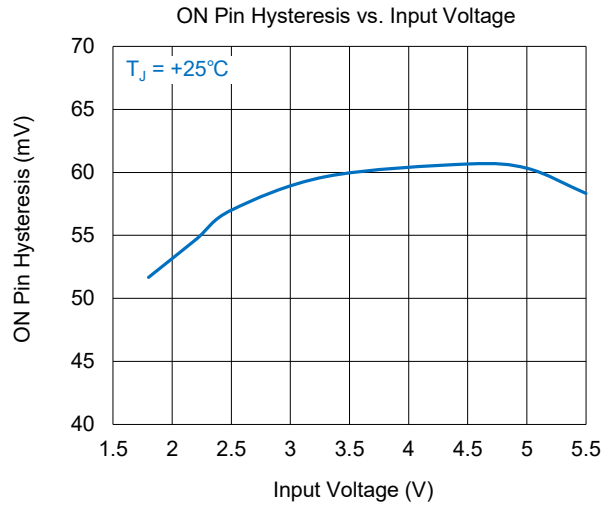
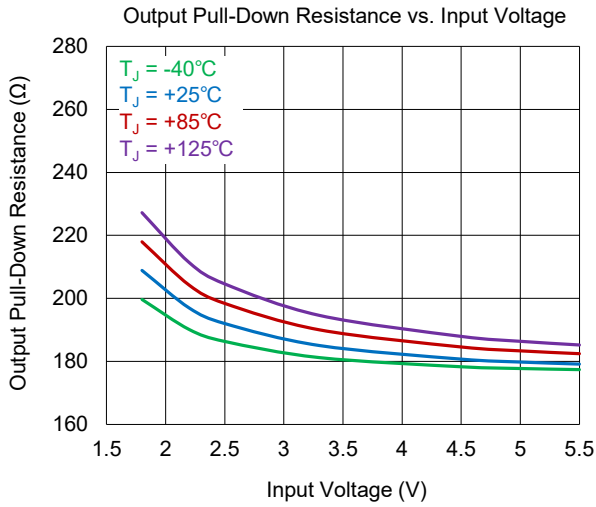



## DETAILED DESCRIPTION

The SGM2567S is a small, 6-ball, 3.4A load switch. A low on-resistance N-MOSFET is integrated, which makes a low voltage drop across the device. To choose suitable rise time is always used to avoid inrush current.

### Control Pin

The ON pin can control the device. Pulling the ON pin high enables the device. Logic high of V<sub>IH</sub> on the ON pin will enable the device and V<sub>IL</sub> will turn it off. It has the ability to interface with low-voltage GPIO. It can support with 1.8V, 2.5V, 3.3V GPIOs.

### Quick Output Discharge

The quick output discharge (QOD) feature is available for SGM2567S. If the ON pin is pulled low, a discharge resistor of 210Ω (TYP) is connected between V<sub>OUT</sub> and GND pins to prevent the output from floating when the switch is disabled.

ON Pin	IN to OUT	Output Discharge
L	Off	Active
H	On	Disabled

## APPLICATION INFORMATION

SGM2567S is a single channel, up to 3.4A current capability load switch with low on-resistance. The device has a wide input range, which can be used in different terminal devices to set power sequence, reduce inrush current and maintain low standby leakage current. The typical application circuit of SGM2567S is shown in Figure 4.

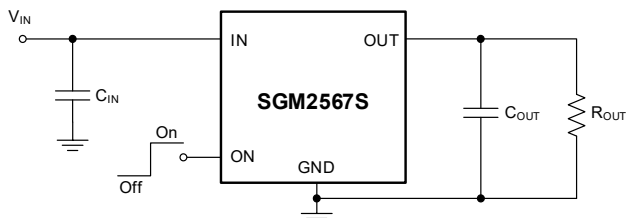

Figure 4. Typical Application Circuit

### Design Requirements

Design Parameter	Example Value
Input Voltage (V <sub>IN</sub> )	3.3V
Load Capacitance (C <sub>OUT</sub> )	4.7μF
Maximum Acceptable Inrush Current (I <sub>INRUSH</sub> )	30mA

### Inrush Current

When the switch is enabled, V<sub>OUT</sub> begins to soft-start from 0V. Inrush current can be calculated by the following formula.

$$I_{\text{INRUSH}} = C_{\text{OUT}} \times \frac{dV_{\text{OUT}}}{dt} \quad (1)$$

Calculate the soft-start time from Equation 1.

$$dt = C_{\text{OUT}} \times V_{\text{OUT}} / I_{\text{INRUSH}} \quad (2)$$

In this example: C<sub>OUT</sub> = 4.7μF, V<sub>OUT</sub> = V<sub>IN</sub> = 3.3V, I<sub>INRUSH</sub> = 30mA.

So,

$$dt = 4.7\mu\text{F} \times 3.3\text{V} / 30\text{mA} \approx 517\mu\text{s} \quad (3)$$

To ensure an inrush current which is less than 30mA, the soft-start time cannot be less than 517μs. The SGM2567S has a typical rise time of 2100μs at 3.3V which meets the above design requirements.

### Input Capacitor

A 1μF input capacitor (C<sub>IN</sub>) is recommended to use between IN and GND close to the device pins. It can limit the voltage drop on the input supply. Larger C<sub>IN</sub> can reduce voltage dip in high current applications.

**APPLICATION INFORMATION (continued)**

**Output Capacitor**

A 0.1μF output capacitor (C<sub>OUT</sub>) should be placed between V<sub>OUT</sub> and GND close to the device pins. This capacitor will prevent parasitic board inductances from forcing V<sub>OUT</sub> below GND when the switch is turned off. To improve the V<sub>IN</sub> drooping when the device is turned on, it is recommended that C<sub>IN</sub> is placed greater than C<sub>OUT</sub>, due to the C<sub>IN</sub> is charge for C<sub>OUT</sub>.

**Over-Current Condition**

The SGM2567S responds to over-current condition when output current exceeds 5.75A (TYP). When an over-current condition is detected, the device maintains a constant output current and reduces the output voltage accordingly.

**Power Supply Recommendations**

The SGM2567S is designed for a wide operate input voltage range of 1.8V to 5.5V. Place a 1μF input bypass capacitor close to the device terminal is recommended.

**Power Supply Sequencing without a GPIO Input**

In many terminal devices, each module needs to be powered up in a pre-determined manner. SGM2567S can set a power sequence by the t<sub>DELAY</sub> without extra GPIO, and may reduce inrush current. Figure 5 shows the sequence that the ON pin of first load switch is tied to the IN, and the second load switch ON pin is tied to the OUT of first load switch. The second load switch is powered up when the first load switch is turned on, this is the fixed sequence and the delay time set by default t<sub>DELAY</sub>.

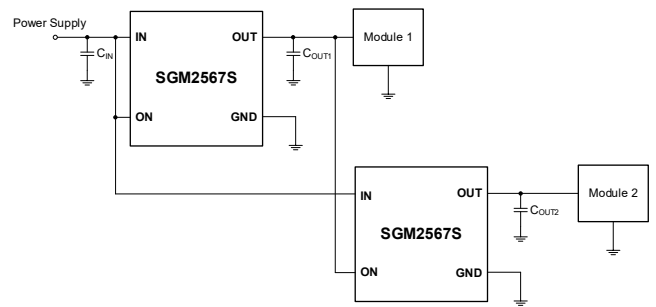

Figure 5. Power Supply Sequencing without a GPIO Input

**REVISION HISTORY**

NOTE: Page numbers for previous revisions may differ from page numbers in the current version.

Changes from Original (DECEMBER 2023) to REV.A	Page
Changed from product preview to production data.....	All

PACKAGE OUTLINE DIMENSIONS

WLCSP-1.5×0.95-6B

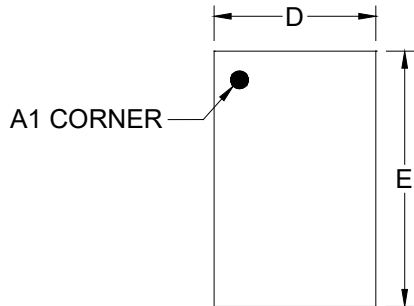

TOP VIEW

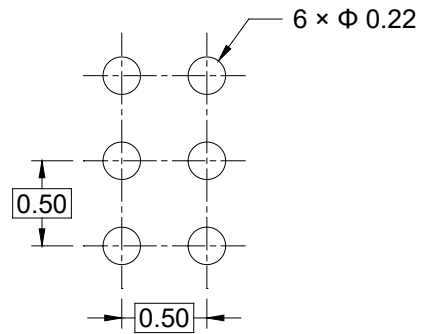

RECOMMENDED LAND PATTERN (Unit: mm)

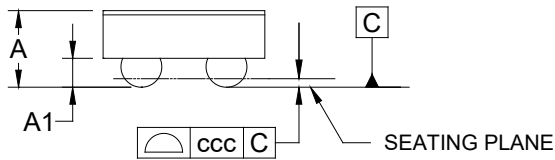

SIDE VIEW

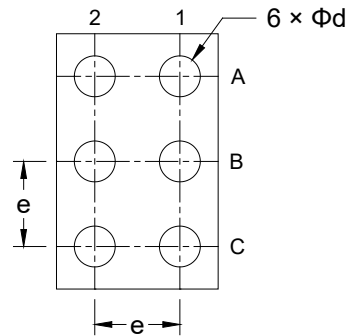

BOTTOM VIEW

Symbol	Dimensions In Millimeters		
	MIN	MOD	MAX
A	-	-	0.495
A1	0.150	-	0.190
D	0.920	-	0.980
E	1.470	-	1.530
d	0.210	-	0.270
e	0.500 BSC		
ccc	0.050		

NOTE: This drawing is subject to change without notice.

# PACKAGE INFORMATION

## TAPE AND REEL INFORMATION

### REEL DIMENSIONS



### TAPE DIMENSIONS



NOTE: The picture is only for reference. Please make the object as the standard.

### KEY PARAMETER LIST OF TAPE AND REEL

Package Type	Reel Diameter	Reel Width W1 (mm)	A0 (mm)	B0 (mm)	K0 (mm)	P0 (mm)	P1 (mm)	P2 (mm)	W (mm)	Pin1 Quadrant
WLCSP-1.5×0.95-6B	7"	9.5	1.04	1.64	0.55	4.0	4.0	2.0	8.0	Q1

000001

# PACKAGE INFORMATION

## CARTON BOX DIMENSIONS



NOTE: The picture is only for reference. Please make the object as the standard.

## KEY PARAMETER LIST OF CARTON BOX

Reel Type	Length (mm)	Width (mm)	Height (mm)	Pizza/Carton
7" (Option)	368	227	224	8
7"	442	410	224	18

DD0002