

GENERAL DESCRIPTION

The SGM818 is a low power consumption voltage detector with high accuracy detection. It operates with a supply voltage (V_{DD}) range from 0.9V to 6V. It can provide circuit initialization for DSP-based and processor-based systems. The SGM818 offers tremendous flexibility with an adjustable threshold that is available from 1.2V to 5V with 0.1V increments.

Whenever V_{DD} falls below a factory preset threshold level (V_{TH}), the device will send out a reset signal. This signal will last the whole period until V_{DD} recovers. Once V_{DD} exceeds the release voltage ($V_{TH} + V_{HYS}$), the reset signal will maintain a certain delay time and be released.

The SGM818 is available in a Green SOT-23-3 package. It is specified over the -40°C to $+125^{\circ}\text{C}$ operating temperature range.

TYPICAL APPLICATION

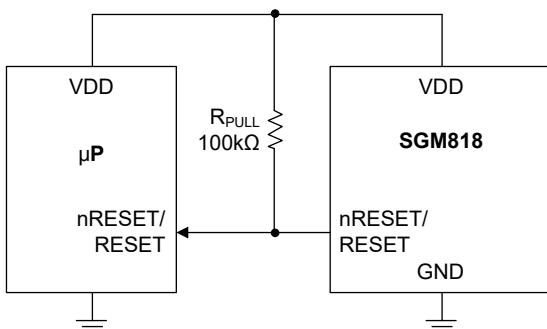

Figure 1. Typical Application Circuit

FEATURES

- **High Accuracy:** $\pm 1\%$ at $T_J = +25^{\circ}\text{C}$
- **Low Supply Current:** $1\mu\text{A}$ (TYP)
- **Detection Voltage Range:** 1.2V to 5V (0.1V Increments)
- **No External Components Required**
- **Quick Reset within $37\mu\text{s}$ (TYP)**
- **Reset Active Timeout Period**
SGM818A: 0.8ms (nRESET)
SGM818B: 51ms (nRESET)
SGM818C: 208ms (nRESET)
SGM818D: 409ms (nRESET)
SGM818E: 0.8ms (RESET)
SGM818F: 51ms (RESET)
SGM818G: 208ms (RESET)
SGM818H: 409ms (RESET)
- **Low Functional Supply Voltage: 0.9V**
- **N-Channel Open-Drain Output**
- **Available in a Green SOT-23-3 Package**

APPLICATIONS

- Computers
- Controllers
- Intelligent Instruments
- Portable Equipment
- μC Power Monitoring
- Battery-Powered Equipment

PACKAGE/ORDERING INFORMATION

MODEL	THRESHOLD VOLTAGE (V)	PACKAGE DESCRIPTION	SPECIFIED TEMPERATURE RANGE	ORDERING NUMBER	PACKAGE MARKING	PACKING OPTION
SGM818A-1.2	1.2	SOT-23-3	-40°C to +125°C	SGM818A-1.2XN3G/TR	GKHXX	Tape and Reel, 3000
		SOT-23-3 (L-Type)	-40°C to +125°C	SGM818A-1.2LXN3G/TR	GKIXX	Tape and Reel, 3000
SGM818A-1.3	1.3	SOT-23-3	-40°C to +125°C	SGM818A-1.3XN3G/TR	GKJXX	Tape and Reel, 3000
		SOT-23-3 (L-Type)	-40°C to +125°C	SGM818A-1.3LXN3G/TR	GKKXX	Tape and Reel, 3000
SGM818A-1.4	1.4	SOT-23-3	-40°C to +125°C	SGM818A-1.4XN3G/TR	GKLXX	Tape and Reel, 3000
		SOT-23-3 (L-Type)	-40°C to +125°C	SGM818A-1.4LXN3G/TR	GKMXX	Tape and Reel, 3000
SGM818A-1.5	1.5	SOT-23-3	-40°C to +125°C	SGM818A-1.5XN3G/TR	GKNXX	Tape and Reel, 3000
		SOT-23-3 (L-Type)	-40°C to +125°C	SGM818A-1.5LXN3G/TR	GKPXX	Tape and Reel, 3000
SGM818A-1.6	1.6	SOT-23-3	-40°C to +125°C	SGM818A-1.6XN3G/TR	GKQXX	Tape and Reel, 3000
		SOT-23-3 (L-Type)	-40°C to +125°C	SGM818A-1.6LXN3G/TR	GKRXX	Tape and Reel, 3000
SGM818A-1.7	1.7	SOT-23-3	-40°C to +125°C	SGM818A-1.7XN3G/TR	GKSXX	Tape and Reel, 3000
		SOT-23-3 (L-Type)	-40°C to +125°C	SGM818A-1.7LXN3G/TR	GKTXX	Tape and Reel, 3000
SGM818A-1.8	1.8	SOT-23-3	-40°C to +125°C	SGM818A-1.8XN3G/TR	GKUXX	Tape and Reel, 3000
		SOT-23-3 (L-Type)	-40°C to +125°C	SGM818A-1.8LXN3G/TR	GKVXX	Tape and Reel, 3000
SGM818A-1.9	1.9	SOT-23-3	-40°C to +125°C	SGM818A-1.9XN3G/TR	GKWXX	Tape and Reel, 3000
		SOT-23-3 (L-Type)	-40°C to +125°C	SGM818A-1.9LXN3G/TR	GKXXX	Tape and Reel, 3000
SGM818A-2.0	2	SOT-23-3	-40°C to +125°C	SGM818A-2.0XN3G/TR	GKYXX	Tape and Reel, 3000
		SOT-23-3 (L-Type)	-40°C to +125°C	SGM818A-2.0LXN3G/TR	GKZXX	Tape and Reel, 3000
SGM818A-2.1	2.1	SOT-23-3	-40°C to +125°C	SGM818A-2.1XN3G/TR	GL0XX	Tape and Reel, 3000
		SOT-23-3 (L-Type)	-40°C to +125°C	SGM818A-2.1LXN3G/TR	GL1XX	Tape and Reel, 3000
SGM818A-2.2	2.2	SOT-23-3	-40°C to +125°C	SGM818A-2.2XN3G/TR	GL3XX	Tape and Reel, 3000
		SOT-23-3 (L-Type)	-40°C to +125°C	SGM818A-2.2LXN3G/TR	GL5XX	Tape and Reel, 3000
SGM818A-2.3	2.3	SOT-23-3	-40°C to +125°C	SGM818A-2.3XN3G/TR	GL8XX	Tape and Reel, 3000
		SOT-23-3 (L-Type)	-40°C to +125°C	SGM818A-2.3LXN3G/TR	GLBXX	Tape and Reel, 3000
SGM818A-2.4	2.4	SOT-23-3	-40°C to +125°C	SGM818A-2.4XN3G/TR	GLCXX	Tape and Reel, 3000
		SOT-23-3 (L-Type)	-40°C to +125°C	SGM818A-2.4LXN3G/TR	GLGXX	Tape and Reel, 3000
SGM818A-2.5	2.5	SOT-23-3	-40°C to +125°C	SGM818A-2.5XN3G/TR	GLHXX	Tape and Reel, 3000
		SOT-23-3 (L-Type)	-40°C to +125°C	SGM818A-2.5LXN3G/TR	GLIXX	Tape and Reel, 3000
SGM818A-2.6	2.6	SOT-23-3	-40°C to +125°C	SGM818A-2.6XN3G/TR	GLJXX	Tape and Reel, 3000
		SOT-23-3 (L-Type)	-40°C to +125°C	SGM818A-2.6LXN3G/TR	GLKXX	Tape and Reel, 3000
SGM818A-2.7	2.7	SOT-23-3	-40°C to +125°C	SGM818A-2.7XN3G/TR	GLLXX	Tape and Reel, 3000
		SOT-23-3 (L-Type)	-40°C to +125°C	SGM818A-2.7LXN3G/TR	GLMXX	Tape and Reel, 3000
SGM818A-2.8	2.8	SOT-23-3	-40°C to +125°C	SGM818A-2.8XN3G/TR	G5ZXX	Tape and Reel, 3000
		SOT-23-3 (L-Type)	-40°C to +125°C	SGM818A-2.8LXN3G/TR	GLNXX	Tape and Reel, 3000

PACKAGE/ORDERING INFORMATION (continued)

MODEL	THRESHOLD VOLTAGE (V)	PACKAGE DESCRIPTION	SPECIFIED TEMPERATURE RANGE	ORDERING NUMBER	PACKAGE MARKING	PACKING OPTION
SGM818A-2.9	2.9	SOT-23-3	-40°C to +125°C	SGM818A-2.9XN3G/TR	GLPXX	Tape and Reel, 3000
		SOT-23-3 (L-Type)	-40°C to +125°C	SGM818A-2.9LXN3G/TR	GLQXX	Tape and Reel, 3000
SGM818A-3.0	3	SOT-23-3	-40°C to +125°C	SGM818A-3.0XN3G/TR	GLRXX	Tape and Reel, 3000
		SOT-23-3 (L-Type)	-40°C to +125°C	SGM818A-3.0LXN3G/TR	GLSXX	Tape and Reel, 3000
SGM818A-3.1	3.1	SOT-23-3	-40°C to +125°C	SGM818A-3.1XN3G/TR	GLTXX	Tape and Reel, 3000
		SOT-23-3 (L-Type)	-40°C to +125°C	SGM818A-3.1LXN3G/TR	GLUXX	Tape and Reel, 3000
SGM818A-3.2	3.2	SOT-23-3	-40°C to +125°C	SGM818A-3.2XN3G/TR	GLVXX	Tape and Reel, 3000
		SOT-23-3 (L-Type)	-40°C to +125°C	SGM818A-3.2LXN3G/TR	GLWXX	Tape and Reel, 3000
SGM818A-3.3	3.3	SOT-23-3	-40°C to +125°C	SGM818A-3.3XN3G/TR	GLXXX	Tape and Reel, 3000
		SOT-23-3 (L-Type)	-40°C to +125°C	SGM818A-3.3LXN3G/TR	GLYXX	Tape and Reel, 3000
SGM818A-3.4	3.4	SOT-23-3	-40°C to +125°C	SGM818A-3.4XN3G/TR	GLZXX	Tape and Reel, 3000
		SOT-23-3 (L-Type)	-40°C to +125°C	SGM818A-3.4LXN3G/TR	GMGXX	Tape and Reel, 3000
SGM818A-3.5	3.5	SOT-23-3	-40°C to +125°C	SGM818A-3.5XN3G/TR	GMHXX	Tape and Reel, 3000
		SOT-23-3 (L-Type)	-40°C to +125°C	SGM818A-3.5LXN3G/TR	GMIXX	Tape and Reel, 3000
SGM818A-3.6	3.6	SOT-23-3	-40°C to +125°C	SGM818A-3.6XN3G/TR	GMJXX	Tape and Reel, 3000
		SOT-23-3 (L-Type)	-40°C to +125°C	SGM818A-3.6LXN3G/TR	GMKXX	Tape and Reel, 3000
SGM818A-3.7	3.7	SOT-23-3	-40°C to +125°C	SGM818A-3.7XN3G/TR	GMLXX	Tape and Reel, 3000
		SOT-23-3 (L-Type)	-40°C to +125°C	SGM818A-3.7LXN3G/TR	GMMXX	Tape and Reel, 3000
SGM818A-3.8	3.8	SOT-23-3	-40°C to +125°C	SGM818A-3.8XN3G/TR	GMNXX	Tape and Reel, 3000
		SOT-23-3 (L-Type)	-40°C to +125°C	SGM818A-3.8LXN3G/TR	GMPXX	Tape and Reel, 3000
SGM818A-3.9	3.9	SOT-23-3	-40°C to +125°C	SGM818A-3.9XN3G/TR	GMQXX	Tape and Reel, 3000
		SOT-23-3 (L-Type)	-40°C to +125°C	SGM818A-3.9LXN3G/TR	GMRXX	Tape and Reel, 3000
SGM818A-4.0	4	SOT-23-3	-40°C to +125°C	SGM818A-4.0XN3G/TR	GMSXX	Tape and Reel, 3000
		SOT-23-3 (L-Type)	-40°C to +125°C	SGM818A-4.0LXN3G/TR	GMUXX	Tape and Reel, 3000
SGM818A-4.1	4.1	SOT-23-3	-40°C to +125°C	SGM818A-4.1XN3G/TR	GMVXX	Tape and Reel, 3000
		SOT-23-3 (L-Type)	-40°C to +125°C	SGM818A-4.1LXN3G/TR	GMWXX	Tape and Reel, 3000
SGM818A-4.2	4.2	SOT-23-3	-40°C to +125°C	SGM818A-4.2XN3G/TR	GMXXX	Tape and Reel, 3000
		SOT-23-3 (L-Type)	-40°C to +125°C	SGM818A-4.2LXN3G/TR	GMYYX	Tape and Reel, 3000
SGM818A-4.3	4.3	SOT-23-3	-40°C to +125°C	SGM818A-4.3XN3G/TR	GMZXX	Tape and Reel, 3000
		SOT-23-3 (L-Type)	-40°C to +125°C	SGM818A-4.3LXN3G/TR	GNGXX	Tape and Reel, 3000
SGM818A-4.4	4.4	SOT-23-3	-40°C to +125°C	SGM818A-4.4XN3G/TR	GNHXX	Tape and Reel, 3000
		SOT-23-3 (L-Type)	-40°C to +125°C	SGM818A-4.4LXN3G/TR	GNIXX	Tape and Reel, 3000
SGM818A-4.5	4.5	SOT-23-3	-40°C to +125°C	SGM818A-4.5XN3G/TR	GNJXX	Tape and Reel, 3000
		SOT-23-3 (L-Type)	-40°C to +125°C	SGM818A-4.5LXN3G/TR	GNKXX	Tape and Reel, 3000

PACKAGE/ORDERING INFORMATION (continued)

MODEL	THRESHOLD VOLTAGE (V)	PACKAGE DESCRIPTION	SPECIFIED TEMPERATURE RANGE	ORDERING NUMBER	PACKAGE MARKING	PACKING OPTION
SGM818A-4.6	4.6	SOT-23-3	-40°C to +125°C	SGM818A-4.6XN3G/TR	GNLXX	Tape and Reel, 3000
		SOT-23-3 (L-Type)	-40°C to +125°C	SGM818A-4.6LXN3G/TR	GNMXX	Tape and Reel, 3000
SGM818A-4.7	4.7	SOT-23-3	-40°C to +125°C	SGM818A-4.7XN3G/TR	GNNXX	Tape and Reel, 3000
		SOT-23-3 (L-Type)	-40°C to +125°C	SGM818A-4.7LXN3G/TR	GNPXX	Tape and Reel, 3000
SGM818A-4.8	4.8	SOT-23-3	-40°C to +125°C	SGM818A-4.8XN3G/TR	GNQXX	Tape and Reel, 3000
		SOT-23-3 (L-Type)	-40°C to +125°C	SGM818A-4.8LXN3G/TR	GNRXX	Tape and Reel, 3000
SGM818A-4.9	4.9	SOT-23-3	-40°C to +125°C	SGM818A-4.9XN3G/TR	GNSXX	Tape and Reel, 3000
		SOT-23-3 (L-Type)	-40°C to +125°C	SGM818A-4.9LXN3G/TR	GNTXX	Tape and Reel, 3000
SGM818A-5.0	5	SOT-23-3	-40°C to +125°C	SGM818A-5.0XN3G/TR	GNUXX	Tape and Reel, 3000
		SOT-23-3 (L-Type)	-40°C to +125°C	SGM818A-5.0LXN3G/TR	GNVXX	Tape and Reel, 3000
SGM818B-1.2	1.2	SOT-23-3	-40°C to +125°C	SGM818B-1.2XN3G/TR	G6UXX	Tape and Reel, 3000
		SOT-23-3 (L-Type)	-40°C to +125°C	SGM818B-1.2LXN3G/TR	GNWXX	Tape and Reel, 3000
SGM818B-1.3	1.3	SOT-23-3	-40°C to +125°C	SGM818B-1.3XN3G/TR	GNXXX	Tape and Reel, 3000
		SOT-23-3 (L-Type)	-40°C to +125°C	SGM818B-1.3LXN3G/TR	GNYXX	Tape and Reel, 3000
SGM818B-1.4	1.4	SOT-23-3	-40°C to +125°C	SGM818B-1.4XN3G/TR	GNZXX	Tape and Reel, 3000
		SOT-23-3 (L-Type)	-40°C to +125°C	SGM818B-1.4LXN3G/TR	GPFXX	Tape and Reel, 3000
SGM818B-1.5	1.5	SOT-23-3	-40°C to +125°C	SGM818B-1.5XN3G/TR	GPGXX	Tape and Reel, 3000
		SOT-23-3 (L-Type)	-40°C to +125°C	SGM818B-1.5LXN3G/TR	GPHXX	Tape and Reel, 3000
SGM818B-1.6	1.6	SOT-23-3	-40°C to +125°C	SGM818B-1.6XN3G/TR	GPIXX	Tape and Reel, 3000
		SOT-23-3 (L-Type)	-40°C to +125°C	SGM818B-1.6LXN3G/TR	GPJXX	Tape and Reel, 3000
SGM818B-1.7	1.7	SOT-23-3	-40°C to +125°C	SGM818B-1.7XN3G/TR	GPKXX	Tape and Reel, 3000
		SOT-23-3 (L-Type)	-40°C to +125°C	SGM818B-1.7LXN3G/TR	GPLXX	Tape and Reel, 3000
SGM818B-1.8	1.8	SOT-23-3	-40°C to +125°C	SGM818B-1.8XN3G/TR	GPMXX	Tape and Reel, 3000
		SOT-23-3 (L-Type)	-40°C to +125°C	SGM818B-1.8LXN3G/TR	GPNXX	Tape and Reel, 3000
SGM818B-1.9	1.9	SOT-23-3	-40°C to +125°C	SGM818B-1.9XN3G/TR	GPPXX	Tape and Reel, 3000
		SOT-23-3 (L-Type)	-40°C to +125°C	SGM818B-1.9LXN3G/TR	GPQXX	Tape and Reel, 3000
SGM818B-2.0	2	SOT-23-3	-40°C to +125°C	SGM818B-2.0XN3G/TR	GPRXX	Tape and Reel, 3000
		SOT-23-3 (L-Type)	-40°C to +125°C	SGM818B-2.0LXN3G/TR	GPSXX	Tape and Reel, 3000
SGM818B-2.1	2.1	SOT-23-3	-40°C to +125°C	SGM818B-2.1XN3G/TR	GPTXX	Tape and Reel, 3000
		SOT-23-3 (L-Type)	-40°C to +125°C	SGM818B-2.1LXN3G/TR	GPUXX	Tape and Reel, 3000
SGM818B-2.2	2.2	SOT-23-3	-40°C to +125°C	SGM818B-2.2XN3G/TR	GPVXX	Tape and Reel, 3000
		SOT-23-3 (L-Type)	-40°C to +125°C	SGM818B-2.2LXN3G/TR	GPWXX	Tape and Reel, 3000
SGM818B-2.3	2.3	SOT-23-3	-40°C to +125°C	SGM818B-2.3XN3G/TR	GPXXX	Tape and Reel, 3000
		SOT-23-3 (L-Type)	-40°C to +125°C	SGM818B-2.3LXN3G/TR	GPYXX	Tape and Reel, 3000

PACKAGE/ORDERING INFORMATION (continued)

MODEL	THRESHOLD VOLTAGE (V)	PACKAGE DESCRIPTION	SPECIFIED TEMPERATURE RANGE	ORDERING NUMBER	PACKAGE MARKING	PACKING OPTION
SGM818B-2.4	2.4	SOT-23-3	-40°C to +125°C	SGM818B-2.4XN3G/TR	GPZXX	Tape and Reel, 3000
		SOT-23-3 (L-Type)	-40°C to +125°C	SGM818B-2.4LXN3G/TR	GQ0XX	Tape and Reel, 3000
SGM818B-2.5	2.5	SOT-23-3	-40°C to +125°C	SGM818B-2.5XN3G/TR	GQ1XX	Tape and Reel, 3000
		SOT-23-3 (L-Type)	-40°C to +125°C	SGM818B-2.5LXN3G/TR	GQ2XX	Tape and Reel, 3000
SGM818B-2.6	2.6	SOT-23-3	-40°C to +125°C	SGM818B-2.6XN3G/TR	GQ3XX	Tape and Reel, 3000
		SOT-23-3 (L-Type)	-40°C to +125°C	SGM818B-2.6LXN3G/TR	GQ4XX	Tape and Reel, 3000
SGM818B-2.7	2.7	SOT-23-3	-40°C to +125°C	SGM818B-2.7XN3G/TR	GQ5XX	Tape and Reel, 3000
		SOT-23-3 (L-Type)	-40°C to +125°C	SGM818B-2.7LXN3G/TR	GQ6XX	Tape and Reel, 3000
SGM818B-2.8	2.8	SOT-23-3	-40°C to +125°C	SGM818B-2.8XN3G/TR	GQ7XX	Tape and Reel, 3000
		SOT-23-3 (L-Type)	-40°C to +125°C	SGM818B-2.8LXN3G/TR	GQ8XX	Tape and Reel, 3000
SGM818B-2.9	2.9	SOT-23-3	-40°C to +125°C	SGM818B-2.9XN3G/TR	GQ9XX	Tape and Reel, 3000
		SOT-23-3 (L-Type)	-40°C to +125°C	SGM818B-2.9LXN3G/TR	GQAXX	Tape and Reel, 3000
SGM818B-3.0	3	SOT-23-3	-40°C to +125°C	SGM818B-3.0XN3G/TR	GQBXX	Tape and Reel, 3000
		SOT-23-3 (L-Type)	-40°C to +125°C	SGM818B-3.0LXN3G/TR	GQCXX	Tape and Reel, 3000
SGM818B-3.1	3.1	SOT-23-3	-40°C to +125°C	SGM818B-3.1XN3G/TR	GQDXX	Tape and Reel, 3000
		SOT-23-3 (L-Type)	-40°C to +125°C	SGM818B-3.1LXN3G/TR	GQEXX	Tape and Reel, 3000
SGM818B-3.2	3.2	SOT-23-3	-40°C to +125°C	SGM818B-3.2XN3G/TR	GQFXX	Tape and Reel, 3000
		SOT-23-3 (L-Type)	-40°C to +125°C	SGM818B-3.2LXN3G/TR	GQGXX	Tape and Reel, 3000
SGM818B-3.3	3.3	SOT-23-3	-40°C to +125°C	SGM818B-3.3XN3G/TR	GQHXX	Tape and Reel, 3000
		SOT-23-3 (L-Type)	-40°C to +125°C	SGM818B-3.3LXN3G/TR	GQIXX	Tape and Reel, 3000
SGM818B-3.4	3.4	SOT-23-3	-40°C to +125°C	SGM818B-3.4XN3G/TR	GQJXX	Tape and Reel, 3000
		SOT-23-3 (L-Type)	-40°C to +125°C	SGM818B-3.4LXN3G/TR	GQKXX	Tape and Reel, 3000
SGM818B-3.5	3.5	SOT-23-3	-40°C to +125°C	SGM818B-3.5XN3G/TR	GQLXX	Tape and Reel, 3000
		SOT-23-3 (L-Type)	-40°C to +125°C	SGM818B-3.5LXN3G/TR	GQMXX	Tape and Reel, 3000
SGM818B-3.6	3.6	SOT-23-3	-40°C to +125°C	SGM818B-3.6XN3G/TR	G6VXX	Tape and Reel, 3000
		SOT-23-3 (L-Type)	-40°C to +125°C	SGM818B-3.6LXN3G/TR	GQNXX	Tape and Reel, 3000
SGM818B-3.7	3.7	SOT-23-3	-40°C to +125°C	SGM818B-3.7XN3G/TR	GQPXX	Tape and Reel, 3000
		SOT-23-3 (L-Type)	-40°C to +125°C	SGM818B-3.7LXN3G/TR	GQQXX	Tape and Reel, 3000
SGM818B-3.8	3.8	SOT-23-3	-40°C to +125°C	SGM818B-3.8XN3G/TR	GQRXX	Tape and Reel, 3000
		SOT-23-3 (L-Type)	-40°C to +125°C	SGM818B-3.8LXN3G/TR	GQSXX	Tape and Reel, 3000
SGM818B-3.9	3.9	SOT-23-3	-40°C to +125°C	SGM818B-3.9XN3G/TR	GQTXX	Tape and Reel, 3000
		SOT-23-3 (L-Type)	-40°C to +125°C	SGM818B-3.9LXN3G/TR	GQUXX	Tape and Reel, 3000
SGM818B-4.0	4	SOT-23-3	-40°C to +125°C	SGM818B-4.0XN3G/TR	GQVXX	Tape and Reel, 3000
		SOT-23-3 (L-Type)	-40°C to +125°C	SGM818B-4.0LXN3G/TR	GQWXX	Tape and Reel, 3000

PACKAGE/ORDERING INFORMATION (continued)

MODEL	THRESHOLD VOLTAGE (V)	PACKAGE DESCRIPTION	SPECIFIED TEMPERATURE RANGE	ORDERING NUMBER	PACKAGE MARKING	PACKING OPTION
SGM818B-4.1	4.1	SOT-23-3	-40°C to +125°C	SGM818B-4.1XN3G/TR	GQXXX	Tape and Reel, 3000
		SOT-23-3 (L-Type)	-40°C to +125°C	SGM818B-4.1LXN3G/TR	GQYXX	Tape and Reel, 3000
SGM818B-4.2	4.2	SOT-23-3	-40°C to +125°C	SGM818B-4.2XN3G/TR	G6WXX	Tape and Reel, 3000
		SOT-23-3 (L-Type)	-40°C to +125°C	SGM818B-4.2LXN3G/TR	GQZXX	Tape and Reel, 3000
SGM818B-4.3	4.3	SOT-23-3	-40°C to +125°C	SGM818B-4.3XN3G/TR	GR1XX	Tape and Reel, 3000
		SOT-23-3 (L-Type)	-40°C to +125°C	SGM818B-4.3LXN3G/TR	GRGXX	Tape and Reel, 3000
SGM818B-4.4	4.4	SOT-23-3	-40°C to +125°C	SGM818B-4.4XN3G/TR	GRHXX	Tape and Reel, 3000
		SOT-23-3 (L-Type)	-40°C to +125°C	SGM818B-4.4LXN3G/TR	GRIXX	Tape and Reel, 3000
SGM818B-4.5	4.5	SOT-23-3	-40°C to +125°C	SGM818B-4.5XN3G/TR	GRJXX	Tape and Reel, 3000
		SOT-23-3 (L-Type)	-40°C to +125°C	SGM818B-4.5LXN3G/TR	GRKXX	Tape and Reel, 3000
SGM818B-4.6	4.6	SOT-23-3	-40°C to +125°C	SGM818B-4.6XN3G/TR	GRLXX	Tape and Reel, 3000
		SOT-23-3 (L-Type)	-40°C to +125°C	SGM818B-4.6LXN3G/TR	GRMXX	Tape and Reel, 3000
SGM818B-4.7	4.7	SOT-23-3	-40°C to +125°C	SGM818B-4.7XN3G/TR	GRNXX	Tape and Reel, 3000
		SOT-23-3 (L-Type)	-40°C to +125°C	SGM818B-4.7LXN3G/TR	GRPXX	Tape and Reel, 3000
SGM818B-4.8	4.8	SOT-23-3	-40°C to +125°C	SGM818B-4.8XN3G/TR	GRQXX	Tape and Reel, 3000
		SOT-23-3 (L-Type)	-40°C to +125°C	SGM818B-4.8LXN3G/TR	GRRXX	Tape and Reel, 3000
SGM818B-4.9	4.9	SOT-23-3	-40°C to +125°C	SGM818B-4.9XN3G/TR	GRSXX	Tape and Reel, 3000
		SOT-23-3 (L-Type)	-40°C to +125°C	SGM818B-4.9LXN3G/TR	GRTXX	Tape and Reel, 3000
SGM818B-5.0	5	SOT-23-3	-40°C to +125°C	SGM818B-5.0XN3G/TR	G6XXX	Tape and Reel, 3000
		SOT-23-3 (L-Type)	-40°C to +125°C	SGM818B-5.0LXN3G/TR	GRUXX	Tape and Reel, 3000
SGM818C-1.2	1.2	SOT-23-3	-40°C to +125°C	SGM818C-1.2XN3G/TR	GRVXX	Tape and Reel, 3000
		SOT-23-3 (L-Type)	-40°C to +125°C	SGM818C-1.2LXN3G/TR	GRWXX	Tape and Reel, 3000
SGM818C-1.3	1.3	SOT-23-3	-40°C to +125°C	SGM818C-1.3XN3G/TR	GRXXX	Tape and Reel, 3000
		SOT-23-3 (L-Type)	-40°C to +125°C	SGM818C-1.3LXN3G/TR	GRYXX	Tape and Reel, 3000
SGM818C-1.4	1.4	SOT-23-3	-40°C to +125°C	SGM818C-1.4XN3G/TR	GRZXX	Tape and Reel, 3000
		SOT-23-3 (L-Type)	-40°C to +125°C	SGM818C-1.4LXN3G/TR	GSBXX	Tape and Reel, 3000
SGM818C-1.5	1.5	SOT-23-3	-40°C to +125°C	SGM818C-1.5XN3G/TR	GSGXX	Tape and Reel, 3000
		SOT-23-3 (L-Type)	-40°C to +125°C	SGM818C-1.5LXN3G/TR	GSHXX	Tape and Reel, 3000
SGM818C-1.6	1.6	SOT-23-3	-40°C to +125°C	SGM818C-1.6XN3G/TR	GSIXX	Tape and Reel, 3000
		SOT-23-3 (L-Type)	-40°C to +125°C	SGM818C-1.6LXN3G/TR	GSJXX	Tape and Reel, 3000
SGM818C-1.7	1.7	SOT-23-3	-40°C to +125°C	SGM818C-1.7XN3G/TR	GSKXX	Tape and Reel, 3000
		SOT-23-3 (L-Type)	-40°C to +125°C	SGM818C-1.7LXN3G/TR	GSLXX	Tape and Reel, 3000
SGM818C-1.8	1.8	SOT-23-3	-40°C to +125°C	SGM818C-1.8XN3G/TR	GSMXX	Tape and Reel, 3000
		SOT-23-3 (L-Type)	-40°C to +125°C	SGM818C-1.8LXN3G/TR	GSNXX	Tape and Reel, 3000

PACKAGE/ORDERING INFORMATION (continued)

MODEL	THRESHOLD VOLTAGE (V)	PACKAGE DESCRIPTION	SPECIFIED TEMPERATURE RANGE	ORDERING NUMBER	PACKAGE MARKING	PACKING OPTION
SGM818C-1.9	1.9	SOT-23-3	-40°C to +125°C	SGM818C-1.9XN3G/TR	GSPXX	Tape and Reel, 3000
		SOT-23-3 (L-Type)	-40°C to +125°C	SGM818C-1.9LXN3G/TR	GSQXX	Tape and Reel, 3000
SGM818C-2.0	2	SOT-23-3	-40°C to +125°C	SGM818C-2.0XN3G/TR	GSRXX	Tape and Reel, 3000
		SOT-23-3 (L-Type)	-40°C to +125°C	SGM818C-2.0LXN3G/TR	GSSXX	Tape and Reel, 3000
SGM818C-2.1	2.1	SOT-23-3	-40°C to +125°C	SGM818C-2.1XN3G/TR	GSTXX	Tape and Reel, 3000
		SOT-23-3 (L-Type)	-40°C to +125°C	SGM818C-2.1LXN3G/TR	GSUXX	Tape and Reel, 3000
SGM818C-2.2	2.2	SOT-23-3	-40°C to +125°C	SGM818C-2.2XN3G/TR	GSVXX	Tape and Reel, 3000
		SOT-23-3 (L-Type)	-40°C to +125°C	SGM818C-2.2LXN3G/TR	GSWXX	Tape and Reel, 3000
SGM818C-2.3	2.3	SOT-23-3	-40°C to +125°C	SGM818C-2.3XN3G/TR	GSXXX	Tape and Reel, 3000
		SOT-23-3 (L-Type)	-40°C to +125°C	SGM818C-2.3LXN3G/TR	GSYXX	Tape and Reel, 3000
SGM818C-2.4	2.4	SOT-23-3	-40°C to +125°C	SGM818C-2.4XN3G/TR	GSZXX	Tape and Reel, 3000
		SOT-23-3 (L-Type)	-40°C to +125°C	SGM818C-2.4LXN3G/TR	GTEXX	Tape and Reel, 3000
SGM818C-2.5	2.5	SOT-23-3	-40°C to +125°C	SGM818C-2.5XN3G/TR	GTGXX	Tape and Reel, 3000
		SOT-23-3 (L-Type)	-40°C to +125°C	SGM818C-2.5LXN3G/TR	GTHXX	Tape and Reel, 3000
SGM818C-2.6	2.6	SOT-23-3	-40°C to +125°C	SGM818C-2.6XN3G/TR	GTIXX	Tape and Reel, 3000
		SOT-23-3 (L-Type)	-40°C to +125°C	SGM818C-2.6LXN3G/TR	GTJXX	Tape and Reel, 3000
SGM818C-2.7	2.7	SOT-23-3	-40°C to +125°C	SGM818C-2.7XN3G/TR	GTKXX	Tape and Reel, 3000
		SOT-23-3 (L-Type)	-40°C to +125°C	SGM818C-2.7LXN3G/TR	GTLXX	Tape and Reel, 3000
SGM818C-2.8	2.8	SOT-23-3	-40°C to +125°C	SGM818C-2.8XN3G/TR	GTMXX	Tape and Reel, 3000
		SOT-23-3 (L-Type)	-40°C to +125°C	SGM818C-2.8LXN3G/TR	GTNXX	Tape and Reel, 3000
SGM818C-2.9	2.9	SOT-23-3	-40°C to +125°C	SGM818C-2.9XN3G/TR	GTPXX	Tape and Reel, 3000
		SOT-23-3 (L-Type)	-40°C to +125°C	SGM818C-2.9LXN3G/TR	GTQXX	Tape and Reel, 3000
SGM818C-3.0	3	SOT-23-3	-40°C to +125°C	SGM818C-3.0XN3G/TR	GTRXX	Tape and Reel, 3000
		SOT-23-3 (L-Type)	-40°C to +125°C	SGM818C-3.0LXN3G/TR	GTSXX	Tape and Reel, 3000
SGM818C-3.1	3.1	SOT-23-3	-40°C to +125°C	SGM818C-3.1XN3G/TR	GTTXX	Tape and Reel, 3000
		SOT-23-3 (L-Type)	-40°C to +125°C	SGM818C-3.1LXN3G/TR	GTUXX	Tape and Reel, 3000
SGM818C-3.2	3.2	SOT-23-3	-40°C to +125°C	SGM818C-3.2XN3G/TR	GTVXX	Tape and Reel, 3000
		SOT-23-3 (L-Type)	-40°C to +125°C	SGM818C-3.2LXN3G/TR	GTWXX	Tape and Reel, 3000
SGM818C-3.3	3.3	SOT-23-3	-40°C to +125°C	SGM818C-3.3XN3G/TR	GTXXX	Tape and Reel, 3000
		SOT-23-3 (L-Type)	-40°C to +125°C	SGM818C-3.3LXN3G/TR	GTYXX	Tape and Reel, 3000
SGM818C-3.4	3.4	SOT-23-3	-40°C to +125°C	SGM818C-3.4XN3G/TR	GTZXX	Tape and Reel, 3000
		SOT-23-3 (L-Type)	-40°C to +125°C	SGM818C-3.4LXN3G/TR	GU8XX	Tape and Reel, 3000
SGM818C-3.5	3.5	SOT-23-3	-40°C to +125°C	SGM818C-3.5XN3G/TR	GU9XX	Tape and Reel, 3000
		SOT-23-3 (L-Type)	-40°C to +125°C	SGM818C-3.5LXN3G/TR	GUAXX	Tape and Reel, 3000

PACKAGE/ORDERING INFORMATION (continued)

MODEL	THRESHOLD VOLTAGE (V)	PACKAGE DESCRIPTION	SPECIFIED TEMPERATURE RANGE	ORDERING NUMBER	PACKAGE MARKING	PACKING OPTION
SGM818C-3.6	3.6	SOT-23-3	-40°C to +125°C	SGM818C-3.6XN3G/TR	GAIXX	Tape and Reel, 3000
		SOT-23-3 (L-Type)	-40°C to +125°C	SGM818C-3.6LXN3G/TR	GUBXX	Tape and Reel, 3000
SGM818C-3.7	3.7	SOT-23-3	-40°C to +125°C	SGM818C-3.7XN3G/TR	GUCXX	Tape and Reel, 3000
		SOT-23-3 (L-Type)	-40°C to +125°C	SGM818C-3.7LXN3G/TR	GUDXX	Tape and Reel, 3000
SGM818C-3.8	3.8	SOT-23-3	-40°C to +125°C	SGM818C-3.8XN3G/TR	GUEXX	Tape and Reel, 3000
		SOT-23-3 (L-Type)	-40°C to +125°C	SGM818C-3.8LXN3G/TR	GUFXX	Tape and Reel, 3000
SGM818C-3.9	3.9	SOT-23-3	-40°C to +125°C	SGM818C-3.9XN3G/TR	GUGXX	Tape and Reel, 3000
		SOT-23-3 (L-Type)	-40°C to +125°C	SGM818C-3.9LXN3G/TR	GUHXX	Tape and Reel, 3000
SGM818C-4.0	4	SOT-23-3	-40°C to +125°C	SGM818C-4.0XN3G/TR	GUIXX	Tape and Reel, 3000
		SOT-23-3 (L-Type)	-40°C to +125°C	SGM818C-4.0LXN3G/TR	GUJXX	Tape and Reel, 3000
SGM818C-4.1	4.1	SOT-23-3	-40°C to +125°C	SGM818C-4.1XN3G/TR	GUKXX	Tape and Reel, 3000
		SOT-23-3 (L-Type)	-40°C to +125°C	SGM818C-4.1LXN3G/TR	GULXX	Tape and Reel, 3000
SGM818C-4.2	4.2	SOT-23-3	-40°C to +125°C	SGM818C-4.2XN3G/TR	GUMXX	Tape and Reel, 3000
		SOT-23-3 (L-Type)	-40°C to +125°C	SGM818C-4.2LXN3G/TR	GUNXX	Tape and Reel, 3000
SGM818C-4.3	4.3	SOT-23-3	-40°C to +125°C	SGM818C-4.3XN3G/TR	GUPXX	Tape and Reel, 3000
		SOT-23-3 (L-Type)	-40°C to +125°C	SGM818C-4.3LXN3G/TR	GUQXX	Tape and Reel, 3000
SGM818C-4.4	4.4	SOT-23-3	-40°C to +125°C	SGM818C-4.4XN3G/TR	GURXX	Tape and Reel, 3000
		SOT-23-3 (L-Type)	-40°C to +125°C	SGM818C-4.4LXN3G/TR	GUSXX	Tape and Reel, 3000
SGM818C-4.5	4.5	SOT-23-3	-40°C to +125°C	SGM818C-4.5XN3G/TR	GUTXX	Tape and Reel, 3000
		SOT-23-3 (L-Type)	-40°C to +125°C	SGM818C-4.5LXN3G/TR	GUUXX	Tape and Reel, 3000
SGM818C-4.6	4.6	SOT-23-3	-40°C to +125°C	SGM818C-4.6XN3G/TR	GUVXX	Tape and Reel, 3000
		SOT-23-3 (L-Type)	-40°C to +125°C	SGM818C-4.6LXN3G/TR	GUWXX	Tape and Reel, 3000
SGM818C-4.7	4.7	SOT-23-3	-40°C to +125°C	SGM818C-4.7XN3G/TR	GUXXX	Tape and Reel, 3000
		SOT-23-3 (L-Type)	-40°C to +125°C	SGM818C-4.7LXN3G/TR	GUYXX	Tape and Reel, 3000
SGM818C-4.8	4.8	SOT-23-3	-40°C to +125°C	SGM818C-4.8XN3G/TR	GUZXX	Tape and Reel, 3000
		SOT-23-3 (L-Type)	-40°C to +125°C	SGM818C-4.8LXN3G/TR	GV0XX	Tape and Reel, 3000
SGM818C-4.9	4.9	SOT-23-3	-40°C to +125°C	SGM818C-4.9XN3G/TR	GVGXX	Tape and Reel, 3000
		SOT-23-3 (L-Type)	-40°C to +125°C	SGM818C-4.9LXN3G/TR	GVHXX	Tape and Reel, 3000
SGM818C-5.0	5	SOT-23-3	-40°C to +125°C	SGM818C-5.0XN3G/TR	GVIXX	Tape and Reel, 3000
		SOT-23-3 (L-Type)	-40°C to +125°C	SGM818C-5.0LXN3G/TR	GVJXX	Tape and Reel, 3000
SGM818D-1.2	1.2	SOT-23-3	-40°C to +125°C	SGM818D-1.2XN3G/TR	GVKXX	Tape and Reel, 3000
		SOT-23-3 (L-Type)	-40°C to +125°C	SGM818D-1.2LXN3G/TR	GVLXX	Tape and Reel, 3000
SGM818D-1.3	1.3	SOT-23-3	-40°C to +125°C	SGM818D-1.3XN3G/TR	GVMXX	Tape and Reel, 3000
		SOT-23-3 (L-Type)	-40°C to +125°C	SGM818D-1.3LXN3G/TR	GVNXX	Tape and Reel, 3000

PACKAGE/ORDERING INFORMATION (continued)

MODEL	THRESHOLD VOLTAGE (V)	PACKAGE DESCRIPTION	SPECIFIED TEMPERATURE RANGE	ORDERING NUMBER	PACKAGE MARKING	PACKING OPTION
SGM818D-1.4	1.4	SOT-23-3	-40°C to +125°C	SGM818D-1.4XN3G/TR	GVPXX	Tape and Reel, 3000
		SOT-23-3 (L-Type)	-40°C to +125°C	SGM818D-1.4LXN3G/TR	GVQXX	Tape and Reel, 3000
SGM818D-1.5	1.5	SOT-23-3	-40°C to +125°C	SGM818D-1.5XN3G/TR	GVRXX	Tape and Reel, 3000
		SOT-23-3 (L-Type)	-40°C to +125°C	SGM818D-1.5LXN3G/TR	GVSXX	Tape and Reel, 3000
SGM818D-1.6	1.6	SOT-23-3	-40°C to +125°C	SGM818D-1.6XN3G/TR	GVTXX	Tape and Reel, 3000
		SOT-23-3 (L-Type)	-40°C to +125°C	SGM818D-1.6LXN3G/TR	GVUXX	Tape and Reel, 3000
SGM818D-1.7	1.7	SOT-23-3	-40°C to +125°C	SGM818D-1.7XN3G/TR	GVVXX	Tape and Reel, 3000
		SOT-23-3 (L-Type)	-40°C to +125°C	SGM818D-1.7LXN3G/TR	GVWXX	Tape and Reel, 3000
SGM818D-1.8	1.8	SOT-23-3	-40°C to +125°C	SGM818D-1.8XN3G/TR	GVXXX	Tape and Reel, 3000
		SOT-23-3 (L-Type)	-40°C to +125°C	SGM818D-1.8LXN3G/TR	GVYXX	Tape and Reel, 3000
SGM818D-1.9	1.9	SOT-23-3	-40°C to +125°C	SGM818D-1.9XN3G/TR	GVZXX	Tape and Reel, 3000
		SOT-23-3 (L-Type)	-40°C to +125°C	SGM818D-1.9LXN3G/TR	GW4XX	Tape and Reel, 3000
SGM818D-2.0	2	SOT-23-3	-40°C to +125°C	SGM818D-2.0XN3G/TR	GW5XX	Tape and Reel, 3000
		SOT-23-3 (L-Type)	-40°C to +125°C	SGM818D-2.0LXN3G/TR	GWDXX	Tape and Reel, 3000
SGM818D-2.1	2.1	SOT-23-3	-40°C to +125°C	SGM818D-2.1XN3G/TR	GWEXX	Tape and Reel, 3000
		SOT-23-3 (L-Type)	-40°C to +125°C	SGM818D-2.1LXN3G/TR	GWFXX	Tape and Reel, 3000
SGM818D-2.2	2.2	SOT-23-3	-40°C to +125°C	SGM818D-2.2XN3G/TR	GWGXX	Tape and Reel, 3000
		SOT-23-3 (L-Type)	-40°C to +125°C	SGM818D-2.2LXN3G/TR	GWHXX	Tape and Reel, 3000
SGM818D-2.3	2.3	SOT-23-3	-40°C to +125°C	SGM818D-2.3XN3G/TR	GWIXX	Tape and Reel, 3000
		SOT-23-3 (L-Type)	-40°C to +125°C	SGM818D-2.3LXN3G/TR	GWJXX	Tape and Reel, 3000
SGM818D-2.4	2.4	SOT-23-3	-40°C to +125°C	SGM818D-2.4XN3G/TR	GWKXX	Tape and Reel, 3000
		SOT-23-3 (L-Type)	-40°C to +125°C	SGM818D-2.4LXN3G/TR	GWLXX	Tape and Reel, 3000
SGM818D-2.5	2.5	SOT-23-3	-40°C to +125°C	SGM818D-2.5XN3G/TR	GWMXX	Tape and Reel, 3000
		SOT-23-3 (L-Type)	-40°C to +125°C	SGM818D-2.5LXN3G/TR	GWNXX	Tape and Reel, 3000
SGM818D-2.6	2.6	SOT-23-3	-40°C to +125°C	SGM818D-2.6XN3G/TR	GWPXX	Tape and Reel, 3000
		SOT-23-3 (L-Type)	-40°C to +125°C	SGM818D-2.6LXN3G/TR	GWQXX	Tape and Reel, 3000
SGM818D-2.7	2.7	SOT-23-3	-40°C to +125°C	SGM818D-2.7XN3G/TR	GWRXX	Tape and Reel, 3000
		SOT-23-3 (L-Type)	-40°C to +125°C	SGM818D-2.7LXN3G/TR	GWSXX	Tape and Reel, 3000
SGM818D-2.8	2.8	SOT-23-3	-40°C to +125°C	SGM818D-2.8XN3G/TR	GWTXX	Tape and Reel, 3000
		SOT-23-3 (L-Type)	-40°C to +125°C	SGM818D-2.8LXN3G/TR	GWUXX	Tape and Reel, 3000
SGM818D-2.9	2.9	SOT-23-3	-40°C to +125°C	SGM818D-2.9XN3G/TR	GVVXX	Tape and Reel, 3000
		SOT-23-3 (L-Type)	-40°C to +125°C	SGM818D-2.9LXN3G/TR	GVWXX	Tape and Reel, 3000
SGM818D-3.0	3	SOT-23-3	-40°C to +125°C	SGM818D-3.0XN3G/TR	GVXXX	Tape and Reel, 3000
		SOT-23-3 (L-Type)	-40°C to +125°C	SGM818D-3.0LXN3G/TR	GVYXX	Tape and Reel, 3000

PACKAGE/ORDERING INFORMATION (continued)

MODEL	THRESHOLD VOLTAGE (V)	PACKAGE DESCRIPTION	SPECIFIED TEMPERATURE RANGE	ORDERING NUMBER	PACKAGE MARKING	PACKING OPTION
SGM818D-3.1	3.1	SOT-23-3	-40°C to +125°C	SGM818D-3.1XN3G/TR	GWZXX	Tape and Reel, 3000
		SOT-23-3 (L-Type)	-40°C to +125°C	SGM818D-3.1LXN3G/TR	GX1XX	Tape and Reel, 3000
SGM818D-3.2	3.2	SOT-23-3	-40°C to +125°C	SGM818D-3.2XN3G/TR	GXGXX	Tape and Reel, 3000
		SOT-23-3 (L-Type)	-40°C to +125°C	SGM818D-3.2LXN3G/TR	GXHXX	Tape and Reel, 3000
SGM818D-3.3	3.3	SOT-23-3	-40°C to +125°C	SGM818D-3.3XN3G/TR	GXIXX	Tape and Reel, 3000
		SOT-23-3 (L-Type)	-40°C to +125°C	SGM818D-3.3LXN3G/TR	GXJXX	Tape and Reel, 3000
SGM818D-3.4	3.4	SOT-23-3	-40°C to +125°C	SGM818D-3.4XN3G/TR	GXKXX	Tape and Reel, 3000
		SOT-23-3 (L-Type)	-40°C to +125°C	SGM818D-3.4LXN3G/TR	GXLXX	Tape and Reel, 3000
SGM818D-3.5	3.5	SOT-23-3	-40°C to +125°C	SGM818D-3.5XN3G/TR	GXMXX	Tape and Reel, 3000
		SOT-23-3 (L-Type)	-40°C to +125°C	SGM818D-3.5LXN3G/TR	GXNXX	Tape and Reel, 3000
SGM818D-3.6	3.6	SOT-23-3	-40°C to +125°C	SGM818D-3.6XN3G/TR	GXPXX	Tape and Reel, 3000
		SOT-23-3 (L-Type)	-40°C to +125°C	SGM818D-3.6LXN3G/TR	GXQXX	Tape and Reel, 3000
SGM818D-3.7	3.7	SOT-23-3	-40°C to +125°C	SGM818D-3.7XN3G/TR	GXRXX	Tape and Reel, 3000
		SOT-23-3 (L-Type)	-40°C to +125°C	SGM818D-3.7LXN3G/TR	GXSXX	Tape and Reel, 3000
SGM818D-3.8	3.8	SOT-23-3	-40°C to +125°C	SGM818D-3.8XN3G/TR	GXTXX	Tape and Reel, 3000
		SOT-23-3 (L-Type)	-40°C to +125°C	SGM818D-3.8LXN3G/TR	GXUXX	Tape and Reel, 3000
SGM818D-3.9	3.9	SOT-23-3	-40°C to +125°C	SGM818D-3.9XN3G/TR	GXVXX	Tape and Reel, 3000
		SOT-23-3 (L-Type)	-40°C to +125°C	SGM818D-3.9LXN3G/TR	GXWXX	Tape and Reel, 3000
SGM818D-4.0	4	SOT-23-3	-40°C to +125°C	SGM818D-4.0XN3G/TR	GXXXX	Tape and Reel, 3000
		SOT-23-3 (L-Type)	-40°C to +125°C	SGM818D-4.0LXN3G/TR	GXYXX	Tape and Reel, 3000
SGM818D-4.1	4.1	SOT-23-3	-40°C to +125°C	SGM818D-4.1XN3G/TR	GXZXX	Tape and Reel, 3000
		SOT-23-3 (L-Type)	-40°C to +125°C	SGM818D-4.1LXN3G/TR	GY0XX	Tape and Reel, 3000
SGM818D-4.2	4.2	SOT-23-3	-40°C to +125°C	SGM818D-4.2XN3G/TR	GY6XX	Tape and Reel, 3000
		SOT-23-3 (L-Type)	-40°C to +125°C	SGM818D-4.2LXN3G/TR	GY7XX	Tape and Reel, 3000
SGM818D-4.3	4.3	SOT-23-3	-40°C to +125°C	SGM818D-4.3XN3G/TR	GYGXX	Tape and Reel, 3000
		SOT-23-3 (L-Type)	-40°C to +125°C	SGM818D-4.3LXN3G/TR	GYHXX	Tape and Reel, 3000
SGM818D-4.4	4.4	SOT-23-3	-40°C to +125°C	SGM818D-4.4XN3G/TR	GYIXX	Tape and Reel, 3000
		SOT-23-3 (L-Type)	-40°C to +125°C	SGM818D-4.4LXN3G/TR	GYJXX	Tape and Reel, 3000
SGM818D-4.5	4.5	SOT-23-3	-40°C to +125°C	SGM818D-4.5XN3G/TR	GYKXX	Tape and Reel, 3000
		SOT-23-3 (L-Type)	-40°C to +125°C	SGM818D-4.5LXN3G/TR	GYLXX	Tape and Reel, 3000
SGM818D-4.6	4.6	SOT-23-3	-40°C to +125°C	SGM818D-4.6XN3G/TR	GYMXX	Tape and Reel, 3000
		SOT-23-3 (L-Type)	-40°C to +125°C	SGM818D-4.6LXN3G/TR	GYNXX	Tape and Reel, 3000
SGM818D-4.7	4.7	SOT-23-3	-40°C to +125°C	SGM818D-4.7XN3G/TR	GYPXX	Tape and Reel, 3000
		SOT-23-3 (L-Type)	-40°C to +125°C	SGM818D-4.7LXN3G/TR	GYQXX	Tape and Reel, 3000

PACKAGE/ORDERING INFORMATION (continued)

MODEL	THRESHOLD VOLTAGE (V)	PACKAGE DESCRIPTION	SPECIFIED TEMPERATURE RANGE	ORDERING NUMBER	PACKAGE MARKING	PACKING OPTION
SGM818D-4.8	4.8	SOT-23-3	-40°C to +125°C	SGM818D-4.8XN3G/TR	GYRXX	Tape and Reel, 3000
		SOT-23-3 (L-Type)	-40°C to +125°C	SGM818D-4.8LXN3G/TR	GYSXX	Tape and Reel, 3000
SGM818D-4.9	4.9	SOT-23-3	-40°C to +125°C	SGM818D-4.9XN3G/TR	GYTXX	Tape and Reel, 3000
		SOT-23-3 (L-Type)	-40°C to +125°C	SGM818D-4.9LXN3G/TR	GYUXX	Tape and Reel, 3000
SGM818D-5.0	5	SOT-23-3	-40°C to +125°C	SGM818D-5.0XN3G/TR	GYVXX	Tape and Reel, 3000
		SOT-23-3 (L-Type)	-40°C to +125°C	SGM818D-5.0LXN3G/TR	GYWXX	Tape and Reel, 3000
SGM818E-1.2	1.2	SOT-23-3	-40°C to +125°C	SGM818E-1.2XN3G/TR	GYXXX	Tape and Reel, 3000
		SOT-23-3 (L-Type)	-40°C to +125°C	SGM818E-1.2LXN3G/TR	GYZXX	Tape and Reel, 3000
SGM818E-1.3	1.3	SOT-23-3	-40°C to +125°C	SGM818E-1.3XN3G/TR	GZAXX	Tape and Reel, 3000
		SOT-23-3 (L-Type)	-40°C to +125°C	SGM818E-1.3LXN3G/TR	GZBXX	Tape and Reel, 3000
SGM818E-1.4	1.4	SOT-23-3	-40°C to +125°C	SGM818E-1.4XN3G/TR	GZCXX	Tape and Reel, 3000
		SOT-23-3 (L-Type)	-40°C to +125°C	SGM818E-1.4LXN3G/TR	GZDXX	Tape and Reel, 3000
SGM818E-1.5	1.5	SOT-23-3	-40°C to +125°C	SGM818E-1.5XN3G/TR	GZEXX	Tape and Reel, 3000
		SOT-23-3 (L-Type)	-40°C to +125°C	SGM818E-1.5LXN3G/TR	GZFXX	Tape and Reel, 3000
SGM818E-1.6	1.6	SOT-23-3	-40°C to +125°C	SGM818E-1.6XN3G/TR	GZGXX	Tape and Reel, 3000
		SOT-23-3 (L-Type)	-40°C to +125°C	SGM818E-1.6LXN3G/TR	GZHXX	Tape and Reel, 3000
SGM818E-1.7	1.7	SOT-23-3	-40°C to +125°C	SGM818E-1.7XN3G/TR	GZIXX	Tape and Reel, 3000
		SOT-23-3 (L-Type)	-40°C to +125°C	SGM818E-1.7LXN3G/TR	GZJXX	Tape and Reel, 3000
SGM818E-1.8	1.8	SOT-23-3	-40°C to +125°C	SGM818E-1.8XN3G/TR	GZKXX	Tape and Reel, 3000
		SOT-23-3 (L-Type)	-40°C to +125°C	SGM818E-1.8LXN3G/TR	GZLXX	Tape and Reel, 3000
SGM818E-1.9	1.9	SOT-23-3	-40°C to +125°C	SGM818E-1.9XN3G/TR	GZMXX	Tape and Reel, 3000
		SOT-23-3 (L-Type)	-40°C to +125°C	SGM818E-1.9LXN3G/TR	GZNXX	Tape and Reel, 3000
SGM818E-2.0	2	SOT-23-3	-40°C to +125°C	SGM818E-2.0XN3G/TR	GZPXX	Tape and Reel, 3000
		SOT-23-3 (L-Type)	-40°C to +125°C	SGM818E-2.0LXN3G/TR	GZQXX	Tape and Reel, 3000
SGM818E-2.1	2.1	SOT-23-3	-40°C to +125°C	SGM818E-2.1XN3G/TR	GZRXX	Tape and Reel, 3000
		SOT-23-3 (L-Type)	-40°C to +125°C	SGM818E-2.1LXN3G/TR	GZSXX	Tape and Reel, 3000
SGM818E-2.2	2.2	SOT-23-3	-40°C to +125°C	SGM818E-2.2XN3G/TR	GZTXX	Tape and Reel, 3000
		SOT-23-3 (L-Type)	-40°C to +125°C	SGM818E-2.2LXN3G/TR	GZUXX	Tape and Reel, 3000
SGM818E-2.3	2.3	SOT-23-3	-40°C to +125°C	SGM818E-2.3XN3G/TR	GZVXX	Tape and Reel, 3000
		SOT-23-3 (L-Type)	-40°C to +125°C	SGM818E-2.3LXN3G/TR	GZWXX	Tape and Reel, 3000
SGM818E-2.4	2.4	SOT-23-3	-40°C to +125°C	SGM818E-2.4XN3G/TR	GZXXX	Tape and Reel, 3000
		SOT-23-3 (L-Type)	-40°C to +125°C	SGM818E-2.4LXN3G/TR	GZYXX	Tape and Reel, 3000
SGM818E-2.5	2.5	SOT-23-3	-40°C to +125°C	SGM818E-2.5XN3G/TR	GZZXX	Tape and Reel, 3000
		SOT-23-3 (L-Type)	-40°C to +125°C	SGM818E-2.5LXN3G/TR	M00XX	Tape and Reel, 3000

PACKAGE/ORDERING INFORMATION (continued)

MODEL	THRESHOLD VOLTAGE (V)	PACKAGE DESCRIPTION	SPECIFIED TEMPERATURE RANGE	ORDERING NUMBER	PACKAGE MARKING	PACKING OPTION
SGM818E-2.6	2.6	SOT-23-3	-40°C to +125°C	SGM818E-2.6XN3G/TR	M01XX	Tape and Reel, 3000
		SOT-23-3 (L-Type)	-40°C to +125°C	SGM818E-2.6LXN3G/TR	M02XX	Tape and Reel, 3000
SGM818E-2.7	2.7	SOT-23-3	-40°C to +125°C	SGM818E-2.7XN3G/TR	M03XX	Tape and Reel, 3000
		SOT-23-3 (L-Type)	-40°C to +125°C	SGM818E-2.7LXN3G/TR	M04XX	Tape and Reel, 3000
SGM818E-2.8	2.8	SOT-23-3	-40°C to +125°C	SGM818E-2.8XN3G/TR	M05XX	Tape and Reel, 3000
		SOT-23-3 (L-Type)	-40°C to +125°C	SGM818E-2.8LXN3G/TR	M06XX	Tape and Reel, 3000
SGM818E-2.9	2.9	SOT-23-3	-40°C to +125°C	SGM818E-2.9XN3G/TR	M07XX	Tape and Reel, 3000
		SOT-23-3 (L-Type)	-40°C to +125°C	SGM818E-2.9LXN3G/TR	M0GXX	Tape and Reel, 3000
SGM818E-3.0	3	SOT-23-3	-40°C to +125°C	SGM818E-3.0XN3G/TR	M0HXX	Tape and Reel, 3000
		SOT-23-3 (L-Type)	-40°C to +125°C	SGM818E-3.0LXN3G/TR	M0IXX	Tape and Reel, 3000
SGM818E-3.1	3.1	SOT-23-3	-40°C to +125°C	SGM818E-3.1XN3G/TR	M0JXX	Tape and Reel, 3000
		SOT-23-3 (L-Type)	-40°C to +125°C	SGM818E-3.1LXN3G/TR	M0KXX	Tape and Reel, 3000
SGM818E-3.2	3.2	SOT-23-3	-40°C to +125°C	SGM818E-3.2XN3G/TR	M0LXX	Tape and Reel, 3000
		SOT-23-3 (L-Type)	-40°C to +125°C	SGM818E-3.2LXN3G/TR	M0MXX	Tape and Reel, 3000
SGM818E-3.3	3.3	SOT-23-3	-40°C to +125°C	SGM818E-3.3XN3G/TR	M0NXX	Tape and Reel, 3000
		SOT-23-3 (L-Type)	-40°C to +125°C	SGM818E-3.3LXN3G/TR	M0PXX	Tape and Reel, 3000
SGM818E-3.4	3.4	SOT-23-3	-40°C to +125°C	SGM818E-3.4XN3G/TR	M0QXX	Tape and Reel, 3000
		SOT-23-3 (L-Type)	-40°C to +125°C	SGM818E-3.4LXN3G/TR	M0RXX	Tape and Reel, 3000
SGM818E-3.5	3.5	SOT-23-3	-40°C to +125°C	SGM818E-3.5XN3G/TR	M0SXX	Tape and Reel, 3000
		SOT-23-3 (L-Type)	-40°C to +125°C	SGM818E-3.5LXN3G/TR	M0TXX	Tape and Reel, 3000
SGM818E-3.6	3.6	SOT-23-3	-40°C to +125°C	SGM818E-3.6XN3G/TR	M0UXX	Tape and Reel, 3000
		SOT-23-3 (L-Type)	-40°C to +125°C	SGM818E-3.6LXN3G/TR	M0VXX	Tape and Reel, 3000
SGM818E-3.7	3.7	SOT-23-3	-40°C to +125°C	SGM818E-3.7XN3G/TR	M0WXX	Tape and Reel, 3000
		SOT-23-3 (L-Type)	-40°C to +125°C	SGM818E-3.7LXN3G/TR	M0XXX	Tape and Reel, 3000
SGM818E-3.8	3.8	SOT-23-3	-40°C to +125°C	SGM818E-3.8XN3G/TR	M0YXX	Tape and Reel, 3000
		SOT-23-3 (L-Type)	-40°C to +125°C	SGM818E-3.8LXN3G/TR	M0ZXX	Tape and Reel, 3000
SGM818E-3.9	3.9	SOT-23-3	-40°C to +125°C	SGM818E-3.9XN3G/TR	M1GXX	Tape and Reel, 3000
		SOT-23-3 (L-Type)	-40°C to +125°C	SGM818E-3.9LXN3G/TR	M1HXX	Tape and Reel, 3000
SGM818E-4.0	4	SOT-23-3	-40°C to +125°C	SGM818E-4.0XN3G/TR	M1JXX	Tape and Reel, 3000
		SOT-23-3 (L-Type)	-40°C to +125°C	SGM818E-4.0LXN3G/TR	M1KXX	Tape and Reel, 3000
SGM818E-4.1	4.1	SOT-23-3	-40°C to +125°C	SGM818E-4.1XN3G/TR	M1LXX	Tape and Reel, 3000
		SOT-23-3 (L-Type)	-40°C to +125°C	SGM818E-4.1LXN3G/TR	M1MXX	Tape and Reel, 3000
SGM818E-4.2	4.2	SOT-23-3	-40°C to +125°C	SGM818E-4.2XN3G/TR	M1NXX	Tape and Reel, 3000
		SOT-23-3 (L-Type)	-40°C to +125°C	SGM818E-4.2LXN3G/TR	M1PXX	Tape and Reel, 3000

PACKAGE/ORDERING INFORMATION (continued)

MODEL	THRESHOLD VOLTAGE (V)	PACKAGE DESCRIPTION	SPECIFIED TEMPERATURE RANGE	ORDERING NUMBER	PACKAGE MARKING	PACKING OPTION
SGM818E-4.3	4.3	SOT-23-3	-40°C to +125°C	SGM818E-4.3XN3G/TR	M1QXX	Tape and Reel, 3000
		SOT-23-3 (L-Type)	-40°C to +125°C	SGM818E-4.3LXN3G/TR	M1RXX	Tape and Reel, 3000
SGM818E-4.4	4.4	SOT-23-3	-40°C to +125°C	SGM818E-4.4XN3G/TR	M1SXX	Tape and Reel, 3000
		SOT-23-3 (L-Type)	-40°C to +125°C	SGM818E-4.4LXN3G/TR	M1TXX	Tape and Reel, 3000
SGM818E-4.5	4.5	SOT-23-3	-40°C to +125°C	SGM818E-4.5XN3G/TR	M1UXX	Tape and Reel, 3000
		SOT-23-3 (L-Type)	-40°C to +125°C	SGM818E-4.5LXN3G/TR	M1VXX	Tape and Reel, 3000
SGM818E-4.6	4.6	SOT-23-3	-40°C to +125°C	SGM818E-4.6XN3G/TR	M1WXX	Tape and Reel, 3000
		SOT-23-3 (L-Type)	-40°C to +125°C	SGM818E-4.6LXN3G/TR	M1XXX	Tape and Reel, 3000
SGM818E-4.7	4.7	SOT-23-3	-40°C to +125°C	SGM818E-4.7XN3G/TR	M1YXX	Tape and Reel, 3000
		SOT-23-3 (L-Type)	-40°C to +125°C	SGM818E-4.7LXN3G/TR	M1ZXX	Tape and Reel, 3000
SGM818E-4.8	4.8	SOT-23-3	-40°C to +125°C	SGM818E-4.8XN3G/TR	M2GXX	Tape and Reel, 3000
		SOT-23-3 (L-Type)	-40°C to +125°C	SGM818E-4.8LXN3G/TR	M2HXX	Tape and Reel, 3000
SGM818E-4.9	4.9	SOT-23-3	-40°C to +125°C	SGM818E-4.9XN3G/TR	M2IXX	Tape and Reel, 3000
		SOT-23-3 (L-Type)	-40°C to +125°C	SGM818E-4.9LXN3G/TR	M2JXX	Tape and Reel, 3000
SGM818E-5.0	5	SOT-23-3	-40°C to +125°C	SGM818E-5.0XN3G/TR	M2KXX	Tape and Reel, 3000
		SOT-23-3 (L-Type)	-40°C to +125°C	SGM818E-5.0LXN3G/TR	M2LXX	Tape and Reel, 3000
SGM818F-1.2	1.2	SOT-23-3	-40°C to +125°C	SGM818F-1.2XN3G/TR	M2MXX	Tape and Reel, 3000
		SOT-23-3 (L-Type)	-40°C to +125°C	SGM818F-1.2LXN3G/TR	M2NXX	Tape and Reel, 3000
SGM818F-1.3	1.3	SOT-23-3	-40°C to +125°C	SGM818F-1.3XN3G/TR	M2PXX	Tape and Reel, 3000
		SOT-23-3 (L-Type)	-40°C to +125°C	SGM818F-1.3LXN3G/TR	M2QXX	Tape and Reel, 3000
SGM818F-1.4	1.4	SOT-23-3	-40°C to +125°C	SGM818F-1.4XN3G/TR	M2RXX	Tape and Reel, 3000
		SOT-23-3 (L-Type)	-40°C to +125°C	SGM818F-1.4LXN3G/TR	M2SXX	Tape and Reel, 3000
SGM818F-1.5	1.5	SOT-23-3	-40°C to +125°C	SGM818F-1.5XN3G/TR	M2TXX	Tape and Reel, 3000
		SOT-23-3 (L-Type)	-40°C to +125°C	SGM818F-1.5LXN3G/TR	M2UXX	Tape and Reel, 3000
SGM818F-1.6	1.6	SOT-23-3	-40°C to +125°C	SGM818F-1.6XN3G/TR	M2VXX	Tape and Reel, 3000
		SOT-23-3 (L-Type)	-40°C to +125°C	SGM818F-1.6LXN3G/TR	M2WXX	Tape and Reel, 3000
SGM818F-1.7	1.7	SOT-23-3	-40°C to +125°C	SGM818F-1.7XN3G/TR	M2XXX	Tape and Reel, 3000
		SOT-23-3 (L-Type)	-40°C to +125°C	SGM818F-1.7LXN3G/TR	M2YXX	Tape and Reel, 3000
SGM818F-1.8	1.8	SOT-23-3	-40°C to +125°C	SGM818F-1.8XN3G/TR	M2ZXX	Tape and Reel, 3000
		SOT-23-3 (L-Type)	-40°C to +125°C	SGM818F-1.8LXN3G/TR	M31XX	Tape and Reel, 3000
SGM818F-1.9	1.9	SOT-23-3	-40°C to +125°C	SGM818F-1.9XN3G/TR	M36XX	Tape and Reel, 3000
		SOT-23-3 (L-Type)	-40°C to +125°C	SGM818F-1.9LXN3G/TR	M37XX	Tape and Reel, 3000
SGM818F-2.0	2	SOT-23-3	-40°C to +125°C	SGM818F-2.0XN3G/TR	M38XX	Tape and Reel, 3000
		SOT-23-3 (L-Type)	-40°C to +125°C	SGM818F-2.0LXN3G/TR	M39XX	Tape and Reel, 3000

PACKAGE/ORDERING INFORMATION (continued)

MODEL	THRESHOLD VOLTAGE (V)	PACKAGE DESCRIPTION	SPECIFIED TEMPERATURE RANGE	ORDERING NUMBER	PACKAGE MARKING	PACKING OPTION
SGM818F-2.1	2.1	SOT-23-3	-40°C to +125°C	SGM818F-2.1XN3G/TR	M3AXX	Tape and Reel, 3000
		SOT-23-3 (L-Type)	-40°C to +125°C	SGM818F-2.1LXN3G/TR	M3BXX	Tape and Reel, 3000
SGM818F-2.2	2.2	SOT-23-3	-40°C to +125°C	SGM818F-2.2XN3G/TR	M3CXX	Tape and Reel, 3000
		SOT-23-3 (L-Type)	-40°C to +125°C	SGM818F-2.2LXN3G/TR	M3DXX	Tape and Reel, 3000
SGM818F-2.3	2.3	SOT-23-3	-40°C to +125°C	SGM818F-2.3XN3G/TR	M3EXX	Tape and Reel, 3000
		SOT-23-3 (L-Type)	-40°C to +125°C	SGM818F-2.3LXN3G/TR	M3FXX	Tape and Reel, 3000
SGM818F-2.4	2.4	SOT-23-3	-40°C to +125°C	SGM818F-2.4XN3G/TR	M3GXX	Tape and Reel, 3000
		SOT-23-3 (L-Type)	-40°C to +125°C	SGM818F-2.4LXN3G/TR	M3HXX	Tape and Reel, 3000
SGM818F-2.5	2.5	SOT-23-3	-40°C to +125°C	SGM818F-2.5XN3G/TR	M3IXX	Tape and Reel, 3000
		SOT-23-3 (L-Type)	-40°C to +125°C	SGM818F-2.5LXN3G/TR	M3JXX	Tape and Reel, 3000
SGM818F-2.6	2.6	SOT-23-3	-40°C to +125°C	SGM818F-2.6XN3G/TR	M3KXX	Tape and Reel, 3000
		SOT-23-3 (L-Type)	-40°C to +125°C	SGM818F-2.6LXN3G/TR	M3LXX	Tape and Reel, 3000
SGM818F-2.7	2.7	SOT-23-3	-40°C to +125°C	SGM818F-2.7XN3G/TR	M3MXX	Tape and Reel, 3000
		SOT-23-3 (L-Type)	-40°C to +125°C	SGM818F-2.7LXN3G/TR	M3NXX	Tape and Reel, 3000
SGM818F-2.8	2.8	SOT-23-3	-40°C to +125°C	SGM818F-2.8XN3G/TR	M3PXX	Tape and Reel, 3000
		SOT-23-3 (L-Type)	-40°C to +125°C	SGM818F-2.8LXN3G/TR	M3QXX	Tape and Reel, 3000
SGM818F-2.9	2.9	SOT-23-3	-40°C to +125°C	SGM818F-2.9XN3G/TR	M3RXX	Tape and Reel, 3000
		SOT-23-3 (L-Type)	-40°C to +125°C	SGM818F-2.9LXN3G/TR	M3SXX	Tape and Reel, 3000
SGM818F-3.0	3	SOT-23-3	-40°C to +125°C	SGM818F-3.0XN3G/TR	M3TXX	Tape and Reel, 3000
		SOT-23-3 (L-Type)	-40°C to +125°C	SGM818F-3.0LXN3G/TR	M3UXX	Tape and Reel, 3000
SGM818F-3.1	3.1	SOT-23-3	-40°C to +125°C	SGM818F-3.1XN3G/TR	M3VXX	Tape and Reel, 3000
		SOT-23-3 (L-Type)	-40°C to +125°C	SGM818F-3.1LXN3G/TR	M3WXX	Tape and Reel, 3000
SGM818F-3.2	3.2	SOT-23-3	-40°C to +125°C	SGM818F-3.2XN3G/TR	M3XXX	Tape and Reel, 3000
		SOT-23-3 (L-Type)	-40°C to +125°C	SGM818F-3.2LXN3G/TR	M3YXX	Tape and Reel, 3000
SGM818F-3.3	3.3	SOT-23-3	-40°C to +125°C	SGM818F-3.3XN3G/TR	M3ZXX	Tape and Reel, 3000
		SOT-23-3 (L-Type)	-40°C to +125°C	SGM818F-3.3LXN3G/TR	M40XX	Tape and Reel, 3000
SGM818F-3.4	3.4	SOT-23-3	-40°C to +125°C	SGM818F-3.4XN3G/TR	M41XX	Tape and Reel, 3000
		SOT-23-3 (L-Type)	-40°C to +125°C	SGM818F-3.4LXN3G/TR	M42XX	Tape and Reel, 3000
SGM818F-3.5	3.5	SOT-23-3	-40°C to +125°C	SGM818F-3.5XN3G/TR	M43XX	Tape and Reel, 3000
		SOT-23-3 (L-Type)	-40°C to +125°C	SGM818F-3.5LXN3G/TR	M44XX	Tape and Reel, 3000
SGM818F-3.6	3.6	SOT-23-3	-40°C to +125°C	SGM818F-3.6XN3G/TR	M45XX	Tape and Reel, 3000
		SOT-23-3 (L-Type)	-40°C to +125°C	SGM818F-3.6LXN3G/TR	M46XX	Tape and Reel, 3000
SGM818F-3.7	3.7	SOT-23-3	-40°C to +125°C	SGM818F-3.7XN3G/TR	M47XX	Tape and Reel, 3000
		SOT-23-3 (L-Type)	-40°C to +125°C	SGM818F-3.7LXN3G/TR	M48XX	Tape and Reel, 3000

PACKAGE/ORDERING INFORMATION (continued)

MODEL	THRESHOLD VOLTAGE (V)	PACKAGE DESCRIPTION	SPECIFIED TEMPERATURE RANGE	ORDERING NUMBER	PACKAGE MARKING	PACKING OPTION
SGM818F-3.8	3.8	SOT-23-3	-40°C to +125°C	SGM818F-3.8XN3G/TR	M4AXX	Tape and Reel, 3000
		SOT-23-3 (L-Type)	-40°C to +125°C	SGM818F-3.8LXN3G/TR	M4GXX	Tape and Reel, 3000
SGM818F-3.9	3.9	SOT-23-3	-40°C to +125°C	SGM818F-3.9XN3G/TR	M4HXX	Tape and Reel, 3000
		SOT-23-3 (L-Type)	-40°C to +125°C	SGM818F-3.9LXN3G/TR	M4IXX	Tape and Reel, 3000
SGM818F-4.0	4	SOT-23-3	-40°C to +125°C	SGM818F-4.0XN3G/TR	M4JXX	Tape and Reel, 3000
		SOT-23-3 (L-Type)	-40°C to +125°C	SGM818F-4.0LXN3G/TR	M4KXX	Tape and Reel, 3000
SGM818F-4.1	4.1	SOT-23-3	-40°C to +125°C	SGM818F-4.1XN3G/TR	M4LXX	Tape and Reel, 3000
		SOT-23-3 (L-Type)	-40°C to +125°C	SGM818F-4.1LXN3G/TR	M4MXX	Tape and Reel, 3000
SGM818F-4.2	4.2	SOT-23-3	-40°C to +125°C	SGM818F-4.2XN3G/TR	M4NXX	Tape and Reel, 3000
		SOT-23-3 (L-Type)	-40°C to +125°C	SGM818F-4.2LXN3G/TR	M4PXX	Tape and Reel, 3000
SGM818F-4.3	4.3	SOT-23-3	-40°C to +125°C	SGM818F-4.3XN3G/TR	M4QXX	Tape and Reel, 3000
		SOT-23-3 (L-Type)	-40°C to +125°C	SGM818F-4.3LXN3G/TR	M4RXX	Tape and Reel, 3000
SGM818F-4.4	4.4	SOT-23-3	-40°C to +125°C	SGM818F-4.4XN3G/TR	M4SXX	Tape and Reel, 3000
		SOT-23-3 (L-Type)	-40°C to +125°C	SGM818F-4.4LXN3G/TR	M4TXX	Tape and Reel, 3000
SGM818F-4.5	4.5	SOT-23-3	-40°C to +125°C	SGM818F-4.5XN3G/TR	M4UXX	Tape and Reel, 3000
		SOT-23-3 (L-Type)	-40°C to +125°C	SGM818F-4.5LXN3G/TR	M4VXX	Tape and Reel, 3000
SGM818F-4.6	4.6	SOT-23-3	-40°C to +125°C	SGM818F-4.6XN3G/TR	M4WXX	Tape and Reel, 3000
		SOT-23-3 (L-Type)	-40°C to +125°C	SGM818F-4.6LXN3G/TR	M4XXX	Tape and Reel, 3000
SGM818F-4.7	4.7	SOT-23-3	-40°C to +125°C	SGM818F-4.7XN3G/TR	M4YXX	Tape and Reel, 3000
		SOT-23-3 (L-Type)	-40°C to +125°C	SGM818F-4.7LXN3G/TR	M4ZXX	Tape and Reel, 3000
SGM818F-4.8	4.8	SOT-23-3	-40°C to +125°C	SGM818F-4.8XN3G/TR	M5GXX	Tape and Reel, 3000
		SOT-23-3 (L-Type)	-40°C to +125°C	SGM818F-4.8LXN3G/TR	M5HXX	Tape and Reel, 3000
SGM818F-4.9	4.9	SOT-23-3	-40°C to +125°C	SGM818F-4.9XN3G/TR	M5IXX	Tape and Reel, 3000
		SOT-23-3 (L-Type)	-40°C to +125°C	SGM818F-4.9LXN3G/TR	M5JXX	Tape and Reel, 3000
SGM818F-5.0	5	SOT-23-3	-40°C to +125°C	SGM818F-5.0XN3G/TR	M5KXX	Tape and Reel, 3000
		SOT-23-3 (L-Type)	-40°C to +125°C	SGM818F-5.0LXN3G/TR	M5LXX	Tape and Reel, 3000
SGM818G-1.2	1.2	SOT-23-3	-40°C to +125°C	SGM818G-1.2XN3G/TR	M5MXX	Tape and Reel, 3000
		SOT-23-3 (L-Type)	-40°C to +125°C	SGM818G-1.2LXN3G/TR	M5NXX	Tape and Reel, 3000
SGM818G-1.3	1.3	SOT-23-3	-40°C to +125°C	SGM818G-1.3XN3G/TR	M5PXX	Tape and Reel, 3000
		SOT-23-3 (L-Type)	-40°C to +125°C	SGM818G-1.3LXN3G/TR	M5QXX	Tape and Reel, 3000
SGM818G-1.4	1.4	SOT-23-3	-40°C to +125°C	SGM818G-1.4XN3G/TR	M5RXX	Tape and Reel, 3000
		SOT-23-3 (L-Type)	-40°C to +125°C	SGM818G-1.4LXN3G/TR	M5SXX	Tape and Reel, 3000
SGM818G-1.5	1.5	SOT-23-3	-40°C to +125°C	SGM818G-1.5XN3G/TR	M5TXX	Tape and Reel, 3000
		SOT-23-3 (L-Type)	-40°C to +125°C	SGM818G-1.5LXN3G/TR	M5UXX	Tape and Reel, 3000

PACKAGE/ORDERING INFORMATION (continued)

MODEL	THRESHOLD VOLTAGE (V)	PACKAGE DESCRIPTION	SPECIFIED TEMPERATURE RANGE	ORDERING NUMBER	PACKAGE MARKING	PACKING OPTION
SGM818G-1.6	1.6	SOT-23-3	-40°C to +125°C	SGM818G-1.6XN3G/TR	M5VXX	Tape and Reel, 3000
		SOT-23-3 (L-Type)	-40°C to +125°C	SGM818G-1.6LXN3G/TR	M5WXX	Tape and Reel, 3000
SGM818G-1.7	1.7	SOT-23-3	-40°C to +125°C	SGM818G-1.7XN3G/TR	M5XXX	Tape and Reel, 3000
		SOT-23-3 (L-Type)	-40°C to +125°C	SGM818G-1.7LXN3G/TR	M5YXX	Tape and Reel, 3000
SGM818G-1.8	1.8	SOT-23-3	-40°C to +125°C	SGM818G-1.8XN3G/TR	M5ZXX	Tape and Reel, 3000
		SOT-23-3 (L-Type)	-40°C to +125°C	SGM818G-1.8LXN3G/TR	M61XX	Tape and Reel, 3000
SGM818G-1.9	1.9	SOT-23-3	-40°C to +125°C	SGM818G-1.9XN3G/TR	M63XX	Tape and Reel, 3000
		SOT-23-3 (L-Type)	-40°C to +125°C	SGM818G-1.9LXN3G/TR	M68XX	Tape and Reel, 3000
SGM818G-2.0	2	SOT-23-3	-40°C to +125°C	SGM818G-2.0XN3G/TR	M69XX	Tape and Reel, 3000
		SOT-23-3 (L-Type)	-40°C to +125°C	SGM818G-2.0LXN3G/TR	M6AXX	Tape and Reel, 3000
SGM818G-2.1	2.1	SOT-23-3	-40°C to +125°C	SGM818G-2.1XN3G/TR	M6BXX	Tape and Reel, 3000
		SOT-23-3 (L-Type)	-40°C to +125°C	SGM818G-2.1LXN3G/TR	M6CXX	Tape and Reel, 3000
SGM818G-2.2	2.2	SOT-23-3	-40°C to +125°C	SGM818G-2.2XN3G/TR	M6EXX	Tape and Reel, 3000
		SOT-23-3 (L-Type)	-40°C to +125°C	SGM818G-2.2LXN3G/TR	M6GXX	Tape and Reel, 3000
SGM818G-2.3	2.3	SOT-23-3	-40°C to +125°C	SGM818G-2.3XN3G/TR	M6HXX	Tape and Reel, 3000
		SOT-23-3 (L-Type)	-40°C to +125°C	SGM818G-2.3LXN3G/TR	M6IXX	Tape and Reel, 3000
SGM818G-2.4	2.4	SOT-23-3	-40°C to +125°C	SGM818G-2.4XN3G/TR	M6JXX	Tape and Reel, 3000
		SOT-23-3 (L-Type)	-40°C to +125°C	SGM818G-2.4LXN3G/TR	M6KXX	Tape and Reel, 3000
SGM818G-2.5	2.5	SOT-23-3	-40°C to +125°C	SGM818G-2.5XN3G/TR	M6LXX	Tape and Reel, 3000
		SOT-23-3 (L-Type)	-40°C to +125°C	SGM818G-2.5LXN3G/TR	M6MXX	Tape and Reel, 3000
SGM818G-2.6	2.6	SOT-23-3	-40°C to +125°C	SGM818G-2.6XN3G/TR	M6NXX	Tape and Reel, 3000
		SOT-23-3 (L-Type)	-40°C to +125°C	SGM818G-2.6LXN3G/TR	M6PXX	Tape and Reel, 3000
SGM818G-2.7	2.7	SOT-23-3	-40°C to +125°C	SGM818G-2.7XN3G/TR	M6QXX	Tape and Reel, 3000
		SOT-23-3 (L-Type)	-40°C to +125°C	SGM818G-2.7LXN3G/TR	M6RXX	Tape and Reel, 3000
SGM818G-2.8	2.8	SOT-23-3	-40°C to +125°C	SGM818G-2.8XN3G/TR	G6YXX	Tape and Reel, 3000
		SOT-23-3 (L-Type)	-40°C to +125°C	SGM818G-2.8LXN3G/TR	M6SXX	Tape and Reel, 3000
SGM818G-2.9	2.9	SOT-23-3	-40°C to +125°C	SGM818G-2.9XN3G/TR	M6TXX	Tape and Reel, 3000
		SOT-23-3 (L-Type)	-40°C to +125°C	SGM818G-2.9LXN3G/TR	M6UXX	Tape and Reel, 3000
SGM818G-3.0	3	SOT-23-3	-40°C to +125°C	SGM818G-3.0XN3G/TR	M6VXX	Tape and Reel, 3000
		SOT-23-3 (L-Type)	-40°C to +125°C	SGM818G-3.0LXN3G/TR	M6WXX	Tape and Reel, 3000
SGM818G-3.1	3.1	SOT-23-3	-40°C to +125°C	SGM818G-3.1XN3G/TR	M6XXX	Tape and Reel, 3000
		SOT-23-3 (L-Type)	-40°C to +125°C	SGM818G-3.1LXN3G/TR	M6YXX	Tape and Reel, 3000
SGM818G-3.2	3.2	SOT-23-3	-40°C to +125°C	SGM818G-3.2XN3G/TR	M6ZXX	Tape and Reel, 3000
		SOT-23-3 (L-Type)	-40°C to +125°C	SGM818G-3.2LXN3G/TR	M7GXX	Tape and Reel, 3000

PACKAGE/ORDERING INFORMATION (continued)

MODEL	THRESHOLD VOLTAGE (V)	PACKAGE DESCRIPTION	SPECIFIED TEMPERATURE RANGE	ORDERING NUMBER	PACKAGE MARKING	PACKING OPTION
SGM818G-3.3	3.3	SOT-23-3	-40°C to +125°C	SGM818G-3.3XN3G/TR	M7HXX	Tape and Reel, 3000
		SOT-23-3 (L-Type)	-40°C to +125°C	SGM818G-3.3LXN3G/TR	M7IXX	Tape and Reel, 3000
SGM818G-3.4	3.4	SOT-23-3	-40°C to +125°C	SGM818G-3.4XN3G/TR	M7JXX	Tape and Reel, 3000
		SOT-23-3 (L-Type)	-40°C to +125°C	SGM818G-3.4LXN3G/TR	M7KXX	Tape and Reel, 3000
SGM818G-3.5	3.5	SOT-23-3	-40°C to +125°C	SGM818G-3.5XN3G/TR	M7LXX	Tape and Reel, 3000
		SOT-23-3 (L-Type)	-40°C to +125°C	SGM818G-3.5LXN3G/TR	M7MXX	Tape and Reel, 3000
SGM818G-3.6	3.6	SOT-23-3	-40°C to +125°C	SGM818G-3.6XN3G/TR	M7NXX	Tape and Reel, 3000
		SOT-23-3 (L-Type)	-40°C to +125°C	SGM818G-3.6LXN3G/TR	M7PXX	Tape and Reel, 3000
SGM818G-3.7	3.7	SOT-23-3	-40°C to +125°C	SGM818G-3.7XN3G/TR	M7QXX	Tape and Reel, 3000
		SOT-23-3 (L-Type)	-40°C to +125°C	SGM818G-3.7LXN3G/TR	M7RXX	Tape and Reel, 3000
SGM818G-3.8	3.8	SOT-23-3	-40°C to +125°C	SGM818G-3.8XN3G/TR	M7SXX	Tape and Reel, 3000
		SOT-23-3 (L-Type)	-40°C to +125°C	SGM818G-3.8LXN3G/TR	M7TXX	Tape and Reel, 3000
SGM818G-3.9	3.9	SOT-23-3	-40°C to +125°C	SGM818G-3.9XN3G/TR	M7UXX	Tape and Reel, 3000
		SOT-23-3 (L-Type)	-40°C to +125°C	SGM818G-3.9LXN3G/TR	M7VXX	Tape and Reel, 3000
SGM818G-4.0	4	SOT-23-3	-40°C to +125°C	SGM818G-4.0XN3G/TR	M7WXX	Tape and Reel, 3000
		SOT-23-3 (L-Type)	-40°C to +125°C	SGM818G-4.0LXN3G/TR	M7XXX	Tape and Reel, 3000
SGM818G-4.1	4.1	SOT-23-3	-40°C to +125°C	SGM818G-4.1XN3G/TR	M7YXX	Tape and Reel, 3000
		SOT-23-3 (L-Type)	-40°C to +125°C	SGM818G-4.1LXN3G/TR	M7ZXX	Tape and Reel, 3000
SGM818G-4.2	4.2	SOT-23-3	-40°C to +125°C	SGM818G-4.2XN3G/TR	M8GXX	Tape and Reel, 3000
		SOT-23-3 (L-Type)	-40°C to +125°C	SGM818G-4.2LXN3G/TR	M8HXX	Tape and Reel, 3000
SGM818G-4.3	4.3	SOT-23-3	-40°C to +125°C	SGM818G-4.3XN3G/TR	M8IXX	Tape and Reel, 3000
		SOT-23-3 (L-Type)	-40°C to +125°C	SGM818G-4.3LXN3G/TR	M8JXX	Tape and Reel, 3000
SGM818G-4.4	4.4	SOT-23-3	-40°C to +125°C	SGM818G-4.4XN3G/TR	M8KXX	Tape and Reel, 3000
		SOT-23-3 (L-Type)	-40°C to +125°C	SGM818G-4.4LXN3G/TR	M8LXX	Tape and Reel, 3000
SGM818G-4.5	4.5	SOT-23-3	-40°C to +125°C	SGM818G-4.5XN3G/TR	M8MXX	Tape and Reel, 3000
		SOT-23-3 (L-Type)	-40°C to +125°C	SGM818G-4.5LXN3G/TR	M8NXX	Tape and Reel, 3000
SGM818G-4.6	4.6	SOT-23-3	-40°C to +125°C	SGM818G-4.6XN3G/TR	M8PXX	Tape and Reel, 3000
		SOT-23-3 (L-Type)	-40°C to +125°C	SGM818G-4.6LXN3G/TR	M8QXX	Tape and Reel, 3000
SGM818G-4.7	4.7	SOT-23-3	-40°C to +125°C	SGM818G-4.7XN3G/TR	M8RXX	Tape and Reel, 3000
		SOT-23-3 (L-Type)	-40°C to +125°C	SGM818G-4.7LXN3G/TR	M8SXX	Tape and Reel, 3000
SGM818G-4.8	4.8	SOT-23-3	-40°C to +125°C	SGM818G-4.8XN3G/TR	M8TXX	Tape and Reel, 3000
		SOT-23-3 (L-Type)	-40°C to +125°C	SGM818G-4.8LXN3G/TR	M8UXX	Tape and Reel, 3000
SGM818G-4.9	4.9	SOT-23-3	-40°C to +125°C	SGM818G-4.9XN3G/TR	M8VXX	Tape and Reel, 3000
		SOT-23-3 (L-Type)	-40°C to +125°C	SGM818G-4.9LXN3G/TR	M8WXX	Tape and Reel, 3000

PACKAGE/ORDERING INFORMATION (continued)

MODEL	THRESHOLD VOLTAGE (V)	PACKAGE DESCRIPTION	SPECIFIED TEMPERATURE RANGE	ORDERING NUMBER	PACKAGE MARKING	PACKING OPTION
SGM818G-5.0	5	SOT-23-3	-40°C to +125°C	SGM818G-5.0XN3G/TR	M8XXX	Tape and Reel, 3000
		SOT-23-3 (L-Type)	-40°C to +125°C	SGM818G-5.0LXN3G/TR	M8YXX	Tape and Reel, 3000
SGM818H-1.2	1.2	SOT-23-3	-40°C to +125°C	SGM818H-1.2XN3G/TR	M8ZXX	Tape and Reel, 3000
		SOT-23-3 (L-Type)	-40°C to +125°C	SGM818H-1.2LXN3G/TR	M92XX	Tape and Reel, 3000
SGM818H-1.3	1.3	SOT-23-3	-40°C to +125°C	SGM818H-1.3XN3G/TR	M94XX	Tape and Reel, 3000
		SOT-23-3 (L-Type)	-40°C to +125°C	SGM818H-1.3LXN3G/TR	M9FXX	Tape and Reel, 3000
SGM818H-1.4	1.4	SOT-23-3	-40°C to +125°C	SGM818H-1.4XN3G/TR	M9GXX	Tape and Reel, 3000
		SOT-23-3 (L-Type)	-40°C to +125°C	SGM818H-1.4LXN3G/TR	M9HXX	Tape and Reel, 3000
SGM818H-1.5	1.5	SOT-23-3	-40°C to +125°C	SGM818H-1.5XN3G/TR	M9IXX	Tape and Reel, 3000
		SOT-23-3 (L-Type)	-40°C to +125°C	SGM818H-1.5LXN3G/TR	M9JXX	Tape and Reel, 3000
SGM818H-1.6	1.6	SOT-23-3	-40°C to +125°C	SGM818H-1.6XN3G/TR	M9KXX	Tape and Reel, 3000
		SOT-23-3 (L-Type)	-40°C to +125°C	SGM818H-1.6LXN3G/TR	M9LXX	Tape and Reel, 3000
SGM818H-1.7	1.7	SOT-23-3	-40°C to +125°C	SGM818H-1.7XN3G/TR	M9MXX	Tape and Reel, 3000
		SOT-23-3 (L-Type)	-40°C to +125°C	SGM818H-1.7LXN3G/TR	M9NXX	Tape and Reel, 3000
SGM818H-1.8	1.8	SOT-23-3	-40°C to +125°C	SGM818H-1.8XN3G/TR	M9PXX	Tape and Reel, 3000
		SOT-23-3 (L-Type)	-40°C to +125°C	SGM818H-1.8LXN3G/TR	M9QXX	Tape and Reel, 3000
SGM818H-1.9	1.9	SOT-23-3	-40°C to +125°C	SGM818H-1.9XN3G/TR	M9RXX	Tape and Reel, 3000
		SOT-23-3 (L-Type)	-40°C to +125°C	SGM818H-1.9LXN3G/TR	M9SXX	Tape and Reel, 3000
SGM818H-2.0	2	SOT-23-3	-40°C to +125°C	SGM818H-2.0XN3G/TR	M9TXX	Tape and Reel, 3000
		SOT-23-3 (L-Type)	-40°C to +125°C	SGM818H-2.0LXN3G/TR	M9UXX	Tape and Reel, 3000
SGM818H-2.1	2.1	SOT-23-3	-40°C to +125°C	SGM818H-2.1XN3G/TR	M9VXX	Tape and Reel, 3000
		SOT-23-3 (L-Type)	-40°C to +125°C	SGM818H-2.1LXN3G/TR	M9WXX	Tape and Reel, 3000
SGM818H-2.2	2.2	SOT-23-3	-40°C to +125°C	SGM818H-2.2XN3G/TR	M9XXX	Tape and Reel, 3000
		SOT-23-3 (L-Type)	-40°C to +125°C	SGM818H-2.2LXN3G/TR	M9YXX	Tape and Reel, 3000
SGM818H-2.3	2.3	SOT-23-3	-40°C to +125°C	SGM818H-2.3XN3G/TR	M9ZXX	Tape and Reel, 3000
		SOT-23-3 (L-Type)	-40°C to +125°C	SGM818H-2.3LXN3G/TR	MA0XX	Tape and Reel, 3000
SGM818H-2.4	2.4	SOT-23-3	-40°C to +125°C	SGM818H-2.4XN3G/TR	MA1XX	Tape and Reel, 3000
		SOT-23-3 (L-Type)	-40°C to +125°C	SGM818H-2.4LXN3G/TR	MA2XX	Tape and Reel, 3000
SGM818H-2.5	2.5	SOT-23-3	-40°C to +125°C	SGM818H-2.5XN3G/TR	MA3XX	Tape and Reel, 3000
		SOT-23-3 (L-Type)	-40°C to +125°C	SGM818H-2.5LXN3G/TR	MA4XX	Tape and Reel, 3000
SGM818H-2.6	2.6	SOT-23-3	-40°C to +125°C	SGM818H-2.6XN3G/TR	MA5XX	Tape and Reel, 3000
		SOT-23-3 (L-Type)	-40°C to +125°C	SGM818H-2.6LXN3G/TR	MA6XX	Tape and Reel, 3000
SGM818H-2.7	2.7	SOT-23-3	-40°C to +125°C	SGM818H-2.7XN3G/TR	MA7XX	Tape and Reel, 3000
		SOT-23-3 (L-Type)	-40°C to +125°C	SGM818H-2.7LXN3G/TR	MA8XX	Tape and Reel, 3000

PACKAGE/ORDERING INFORMATION (continued)

MODEL	THRESHOLD VOLTAGE (V)	PACKAGE DESCRIPTION	SPECIFIED TEMPERATURE RANGE	ORDERING NUMBER	PACKAGE MARKING	PACKING OPTION
SGM818H-2.8	2.8	SOT-23-3	-40°C to +125°C	SGM818H-2.8XN3G/TR	MA9XX	Tape and Reel, 3000
		SOT-23-3 (L-Type)	-40°C to +125°C	SGM818H-2.8LXN3G/TR	MAAXX	Tape and Reel, 3000
SGM818H-2.9	2.9	SOT-23-3	-40°C to +125°C	SGM818H-2.9XN3G/TR	MABXX	Tape and Reel, 3000
		SOT-23-3 (L-Type)	-40°C to +125°C	SGM818H-2.9LXN3G/TR	MACXX	Tape and Reel, 3000
SGM818H-3.0	3	SOT-23-3	-40°C to +125°C	SGM818H-3.0XN3G/TR	MAEXX	Tape and Reel, 3000
		SOT-23-3 (L-Type)	-40°C to +125°C	SGM818H-3.0LXN3G/TR	MAFXX	Tape and Reel, 3000
SGM818H-3.1	3.1	SOT-23-3	-40°C to +125°C	SGM818H-3.1XN3G/TR	MAGXX	Tape and Reel, 3000
		SOT-23-3 (L-Type)	-40°C to +125°C	SGM818H-3.1LXN3G/TR	MAHXX	Tape and Reel, 3000
SGM818H-3.2	3.2	SOT-23-3	-40°C to +125°C	SGM818H-3.2XN3G/TR	MAIXX	Tape and Reel, 3000
		SOT-23-3 (L-Type)	-40°C to +125°C	SGM818H-3.2LXN3G/TR	MAJXX	Tape and Reel, 3000
SGM818H-3.3	3.3	SOT-23-3	-40°C to +125°C	SGM818H-3.3XN3G/TR	MAKXX	Tape and Reel, 3000
		SOT-23-3 (L-Type)	-40°C to +125°C	SGM818H-3.3LXN3G/TR	MALXX	Tape and Reel, 3000
SGM818H-3.4	3.4	SOT-23-3	-40°C to +125°C	SGM818H-3.4XN3G/TR	MAMXX	Tape and Reel, 3000
		SOT-23-3 (L-Type)	-40°C to +125°C	SGM818H-3.4LXN3G/TR	MANXX	Tape and Reel, 3000
SGM818H-3.5	3.5	SOT-23-3	-40°C to +125°C	SGM818H-3.5XN3G/TR	MAPXX	Tape and Reel, 3000
		SOT-23-3 (L-Type)	-40°C to +125°C	SGM818H-3.5LXN3G/TR	MAQXX	Tape and Reel, 3000
SGM818H-3.6	3.6	SOT-23-3	-40°C to +125°C	SGM818H-3.6XN3G/TR	MARXX	Tape and Reel, 3000
		SOT-23-3 (L-Type)	-40°C to +125°C	SGM818H-3.6LXN3G/TR	MASXX	Tape and Reel, 3000
SGM818H-3.7	3.7	SOT-23-3	-40°C to +125°C	SGM818H-3.7XN3G/TR	MATXX	Tape and Reel, 3000
		SOT-23-3 (L-Type)	-40°C to +125°C	SGM818H-3.7LXN3G/TR	MAUXX	Tape and Reel, 3000
SGM818H-3.8	3.8	SOT-23-3	-40°C to +125°C	SGM818H-3.8XN3G/TR	MAVXX	Tape and Reel, 3000
		SOT-23-3 (L-Type)	-40°C to +125°C	SGM818H-3.8LXN3G/TR	MAWXX	Tape and Reel, 3000
SGM818H-3.9	3.9	SOT-23-3	-40°C to +125°C	SGM818H-3.9XN3G/TR	MAXXX	Tape and Reel, 3000
		SOT-23-3 (L-Type)	-40°C to +125°C	SGM818H-3.9LXN3G/TR	MAYXX	Tape and Reel, 3000
SGM818H-4.0	4	SOT-23-3	-40°C to +125°C	SGM818H-4.0XN3G/TR	MAZXX	Tape and Reel, 3000
		SOT-23-3 (L-Type)	-40°C to +125°C	SGM818H-4.0LXN3G/TR	MB0XX	Tape and Reel, 3000
SGM818H-4.1	4.1	SOT-23-3	-40°C to +125°C	SGM818H-4.1XN3G/TR	MB1XX	Tape and Reel, 3000
		SOT-23-3 (L-Type)	-40°C to +125°C	SGM818H-4.1LXN3G/TR	MB2XX	Tape and Reel, 3000
SGM818H-4.2	4.2	SOT-23-3	-40°C to +125°C	SGM818H-4.2XN3G/TR	MB3XX	Tape and Reel, 3000
		SOT-23-3 (L-Type)	-40°C to +125°C	SGM818H-4.2LXN3G/TR	MB4XX	Tape and Reel, 3000
SGM818H-4.3	4.3	SOT-23-3	-40°C to +125°C	SGM818H-4.3XN3G/TR	MBGXX	Tape and Reel, 3000
		SOT-23-3 (L-Type)	-40°C to +125°C	SGM818H-4.3LXN3G/TR	MBHXX	Tape and Reel, 3000
SGM818H-4.4	4.4	SOT-23-3	-40°C to +125°C	SGM818H-4.4XN3G/TR	MBIXX	Tape and Reel, 3000
		SOT-23-3 (L-Type)	-40°C to +125°C	SGM818H-4.4LXN3G/TR	MBJXX	Tape and Reel, 3000

PACKAGE/ORDERING INFORMATION (continued)

MODEL	THRESHOLD VOLTAGE (V)	PACKAGE DESCRIPTION	SPECIFIED TEMPERATURE RANGE	ORDERING NUMBER	PACKAGE MARKING	PACKING OPTION
SGM818H-4.5	4.5	SOT-23-3	-40°C to +125°C	SGM818H-4.5XN3G/TR	MBKXX	Tape and Reel, 3000
		SOT-23-3 (L-Type)	-40°C to +125°C	SGM818H-4.5LXN3G/TR	MBLXX	Tape and Reel, 3000
SGM818H-4.6	4.6	SOT-23-3	-40°C to +125°C	SGM818H-4.6XN3G/TR	MBMXX	Tape and Reel, 3000
		SOT-23-3 (L-Type)	-40°C to +125°C	SGM818H-4.6LXN3G/TR	MBNXX	Tape and Reel, 3000
SGM818H-4.7	4.7	SOT-23-3	-40°C to +125°C	SGM818H-4.7XN3G/TR	MBPXX	Tape and Reel, 3000
		SOT-23-3 (L-Type)	-40°C to +125°C	SGM818H-4.7LXN3G/TR	MBQXX	Tape and Reel, 3000
SGM818H-4.8	4.8	SOT-23-3	-40°C to +125°C	SGM818H-4.8XN3G/TR	MBRXX	Tape and Reel, 3000
		SOT-23-3 (L-Type)	-40°C to +125°C	SGM818H-4.8LXN3G/TR	MBSXX	Tape and Reel, 3000
SGM818H-4.9	4.9	SOT-23-3	-40°C to +125°C	SGM818H-4.9XN3G/TR	MBTXX	Tape and Reel, 3000
		SOT-23-3 (L-Type)	-40°C to +125°C	SGM818H-4.9LXN3G/TR	MBUXX	Tape and Reel, 3000
SGM818H-5.0	5	SOT-23-3	-40°C to +125°C	SGM818H-5.0XN3G/TR	MBVXX	Tape and Reel, 3000
		SOT-23-3 (L-Type)	-40°C to +125°C	SGM818H-5.0LXN3G/TR	MBWXX	Tape and Reel, 3000

MARKING INFORMATION

NOTE: XX = Date Code.

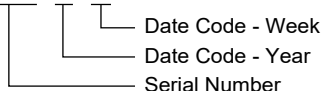
YYY X X

Green (RoHS & HSF): SG Micro Corp defines "Green" to mean Pb-Free (RoHS compatible) and free of halogen substances. If you have additional comments or questions, please contact your SGMICRO representative directly.

ABSOLUTE MAXIMUM RATINGS

Terminal Voltage (with Respect to GND), V_{DD}	-0.3V to 6V
All Other Inputs	-0.3V to 6V
Input Current, I_{VDD}	20mA
Package Thermal Resistance	
SOT-23-3, θ_{JA}	340°C/W
Junction Temperature	+150°C
Storage Temperature Range	-65°C to +150°C
Lead Temperature (Soldering, 10s)	+260°C
ESD Susceptibility	
HBM	4000V
CDM	400V

RECOMMENDED OPERATING CONDITIONS

Operating Junction Temperature Range..... -40°C to +125°C

OVERSTRESS CAUTION

Stresses beyond those listed in Absolute Maximum Ratings may cause permanent damage to the device. Exposure to absolute maximum rating conditions for extended periods may affect reliability. Functional operation of the device at any conditions beyond those indicated in the Recommended Operating Conditions section is not implied.

ESD SENSITIVITY CAUTION

This integrated circuit can be damaged if ESD protections are not considered carefully. SGMICRO recommends that all integrated circuits be handled with appropriate precautions. Failure to observe proper handling and installation procedures can cause damage. ESD damage can range from subtle performance degradation to complete device failure. Precision integrated circuits may be more susceptible to damage because even small parametric changes could cause the device not to meet the published specifications.

DISCLAIMER

SG Micro Corp reserves the right to make any change in circuit design, or specifications without prior notice.

PIN CONFIGURATIONS

SGM818A/SGM818B/SGM818C/SGM818D

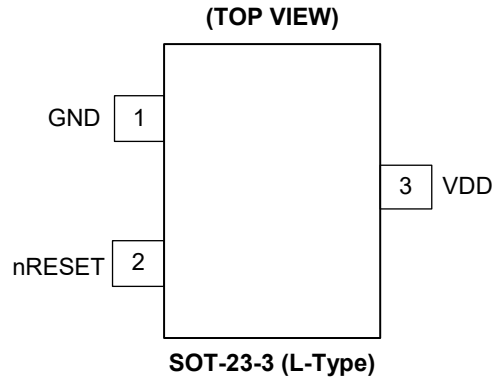
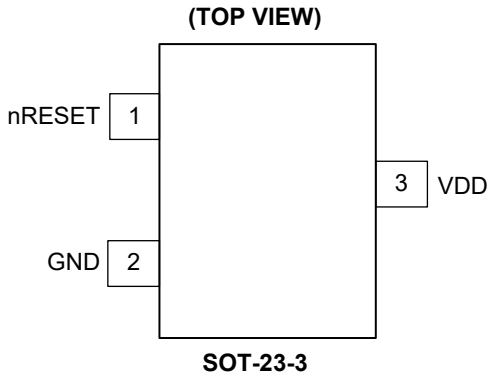

SGM818E/SGM818F/SGM818G/SGM818H

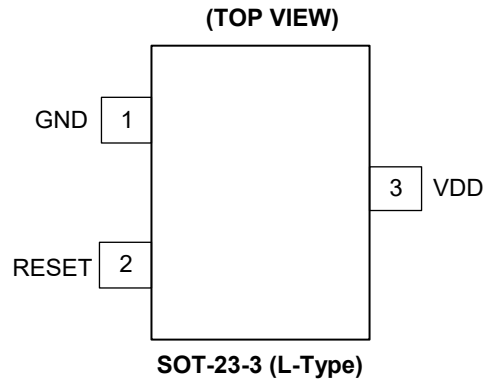
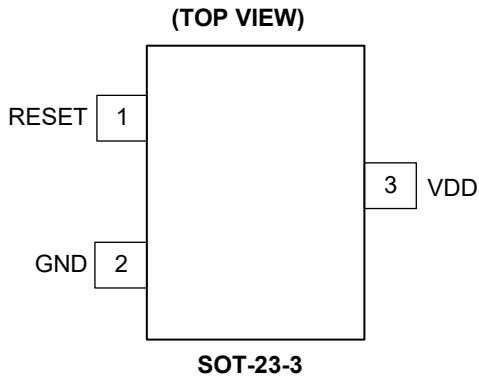

PIN DESCRIPTION

PIN		NAME	FUNCTION
SOT-23-3	SOT-23-3 (L-Type)		
2	1	GND	Ground.
1	2	nRESET	Active-Low Reset Output Pin. (Version A, B, C, D)
		RESET	Active-High Reset Output. (Version E, F, G, H)
3	3	VDD	Power Pin.

ELECTRICAL CHARACTERISTICS

($V_{DD} = 3V$, $T_J = +25^\circ C$, unless otherwise noted.)

PARAMETER	SYMBOL	CONDITIONS	MIN	TYP	MAX	UNITS
Operating V_{DD} (V_{OUT}) Range	V_{DD}		0.9		6	V
Supply Current	I_{DD}	$V_{TH} = 3V$, $V_{DD} = 4.5V$, $T_J = +25^\circ C$		1	2	μA
Reset Threshold	V_{TH}			1.2 to 5		V
Threshold Voltage Accuracy	ΔV_{TH}	$T_J = +25^\circ C$	-1		1	%
V_{DD} Drop to Reset Delay	t_{RD}	Drop = $V_{TH} - 125mV$		37		μs
Reset Active Timeout Period	SGM818A/E	$V_{DD} \geq 1.02 \times V_{TH}$		0.8		ms
	SGM818B/F		34	51	70	
	SGM818C/G		146	208	274	
	SGM818D/H		268	409	543	
RESET Output Voltage Low ⁽¹⁾	V_{OL}	$1.5V = V_{DD} < V_{TH}$, $I_{SINK} = 3.5mA$			0.4	V
Hysteresis Width	V_{HYS}			$0.64\% \times V_{TH}$	$1.6\% \times V_{TH}$	V

NOTE:

1. V_{OL} can be calculated by $V_{OL} = V_{DD} - I_R \times R_{PU}$, where R_{PU} is the pull-up resistor and I_R is the current flowing through the pull-up resistor. For typical application, R_{PU} is 100k Ω and V_{OL} is less than 0.2V.

TIMING DIAGRAM

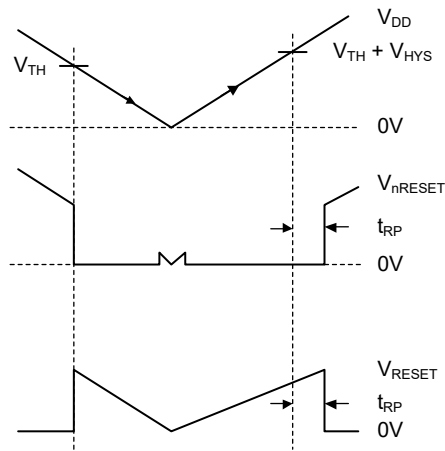
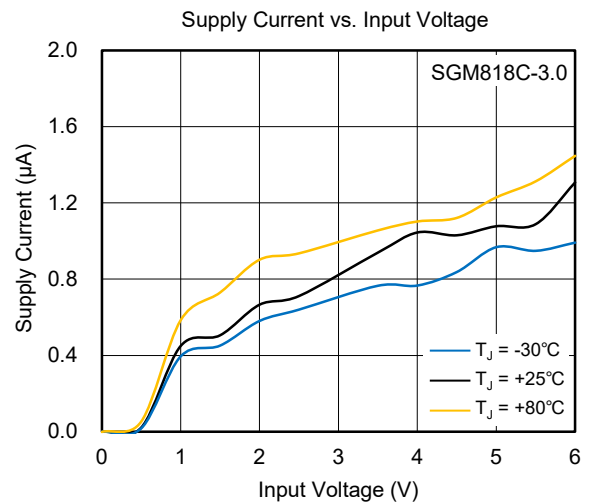
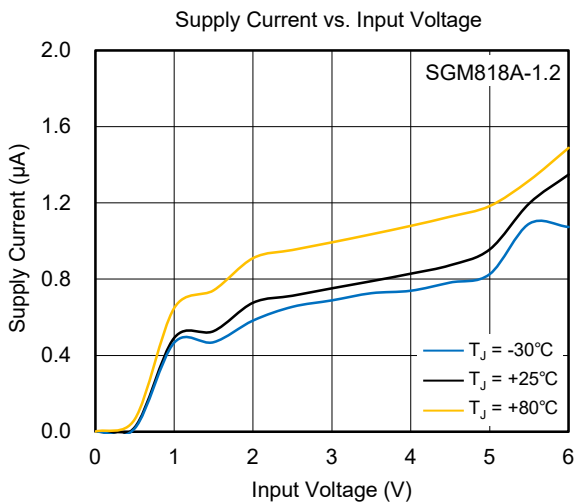
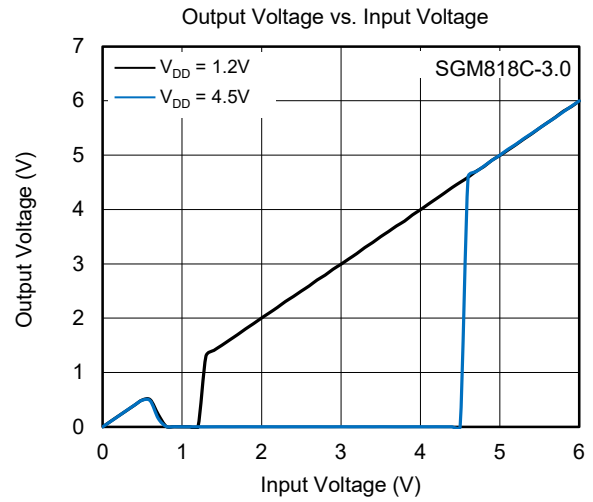
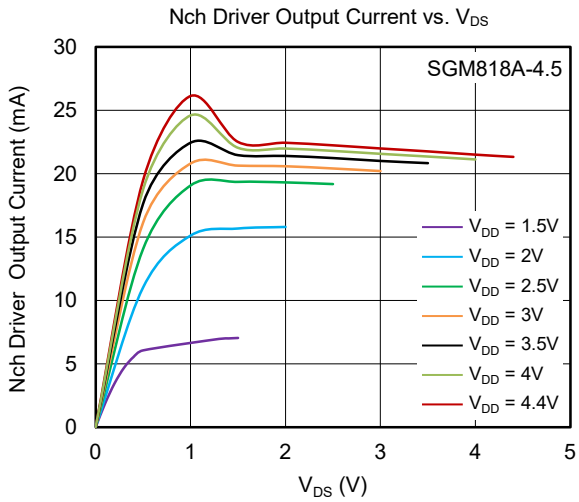
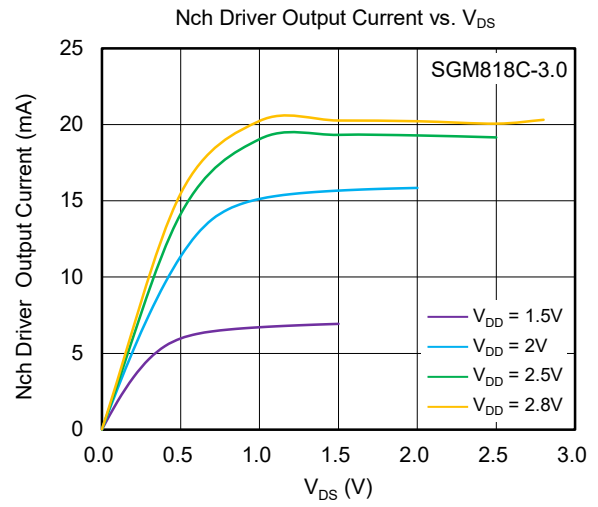
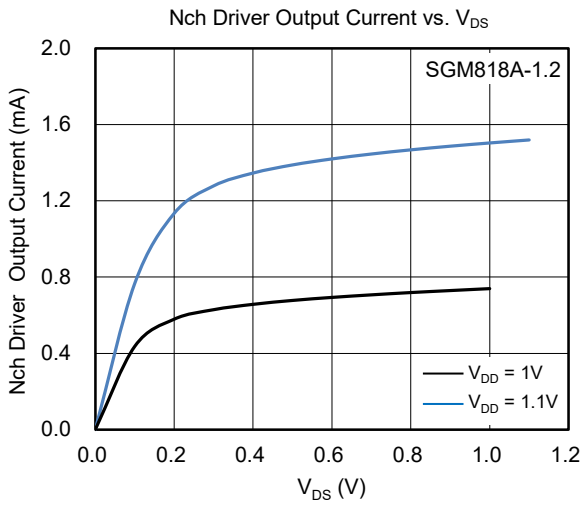
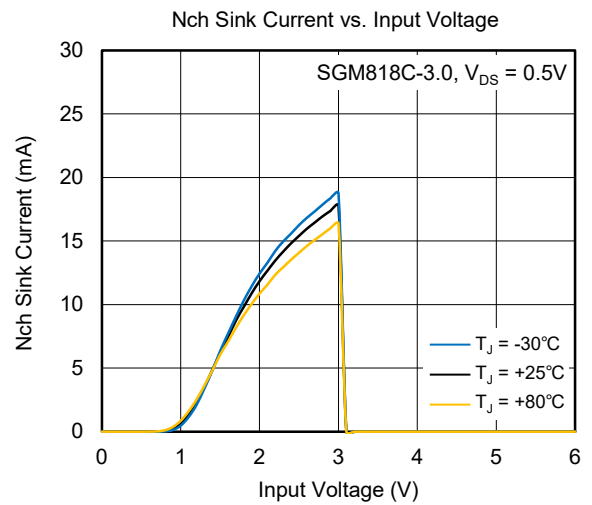
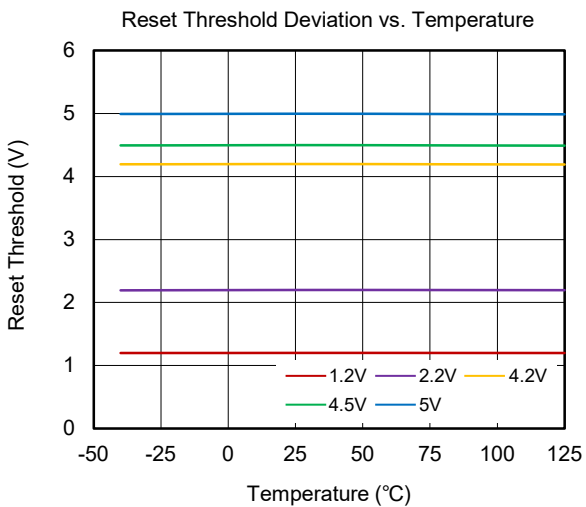
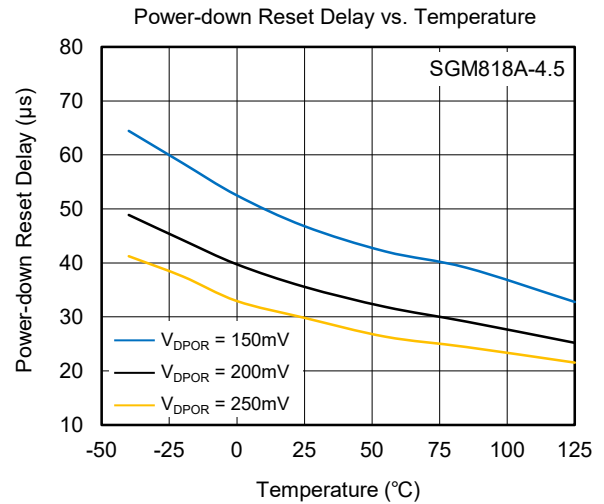
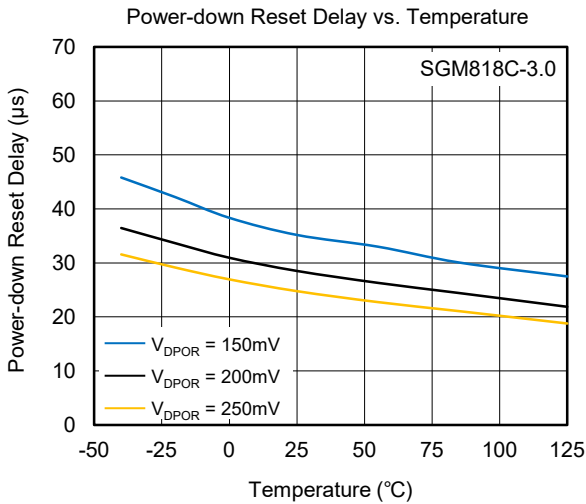
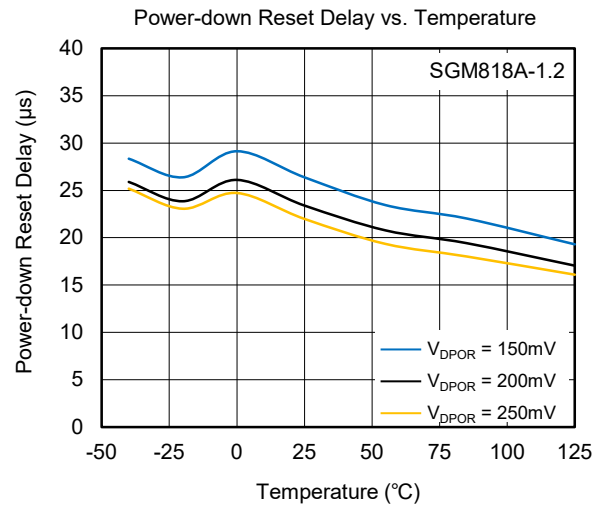
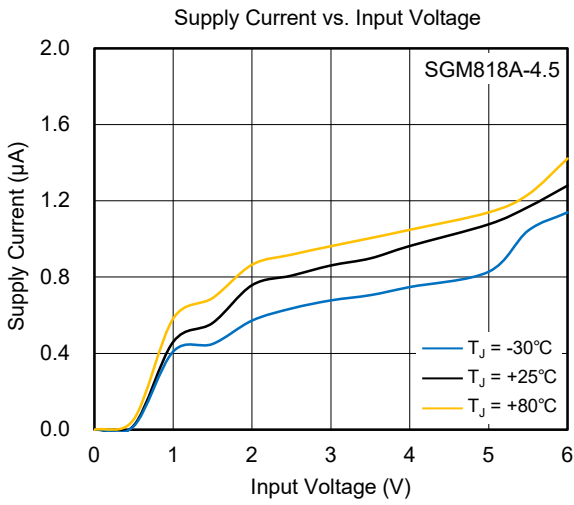

Figure 2. Timing Diagram

TYPICAL PERFORMANCE CHARACTERISTICS



TYPICAL PERFORMANCE CHARACTERISTICS (continued)



TYPICAL PERFORMANCE CHARACTERISTICS (continued)

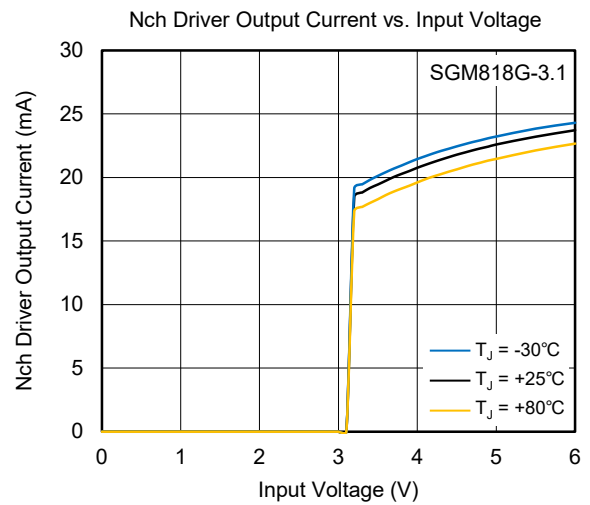
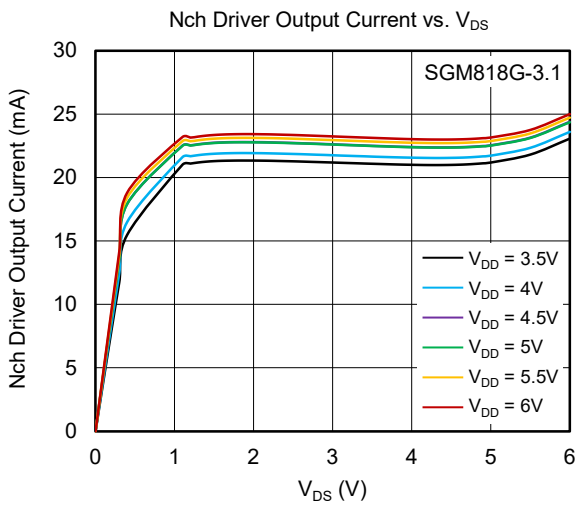
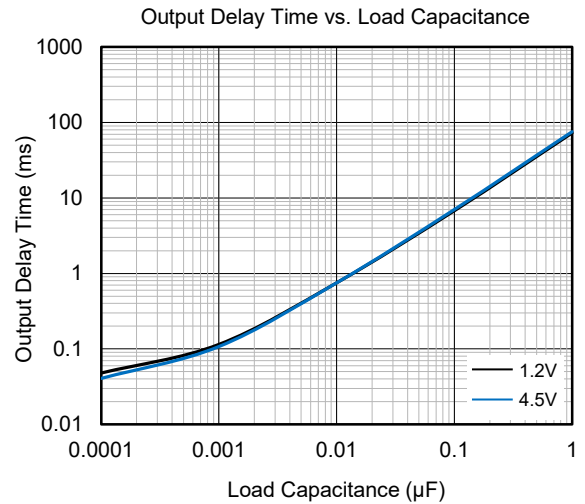
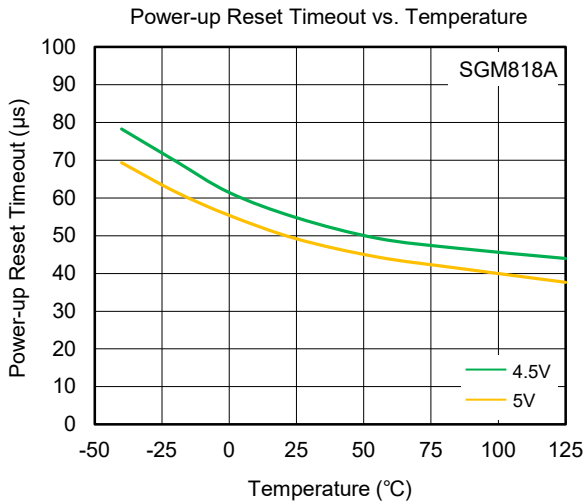
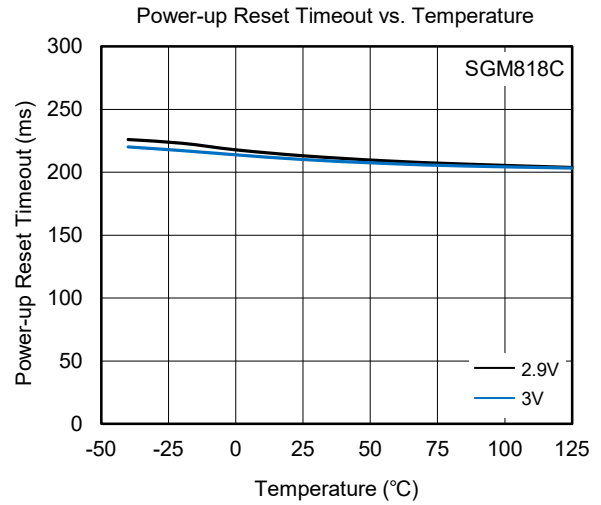
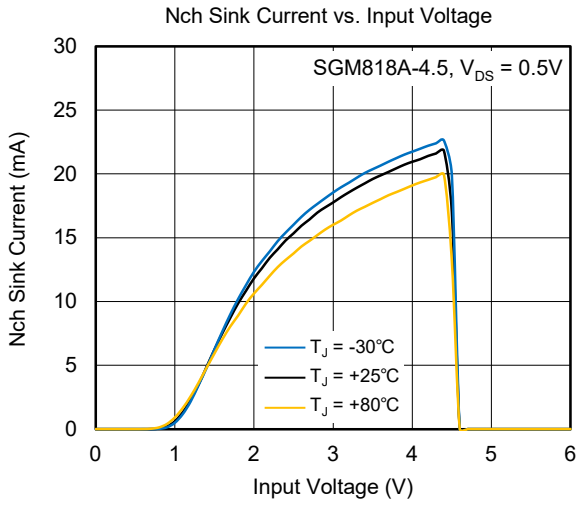

TYPICAL PERFORMANCE CHARACTERISTICS (continued)

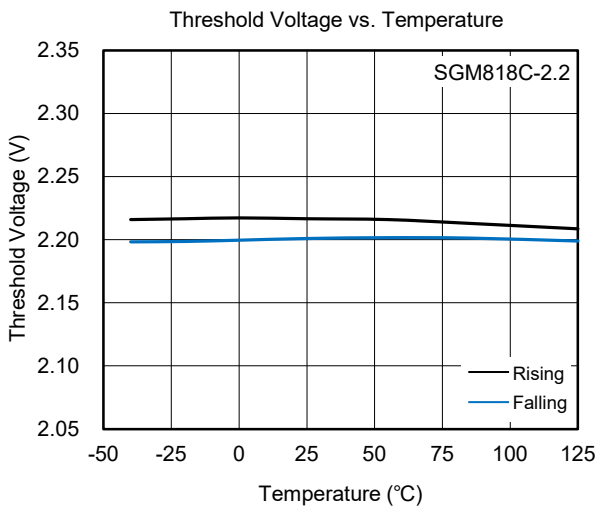
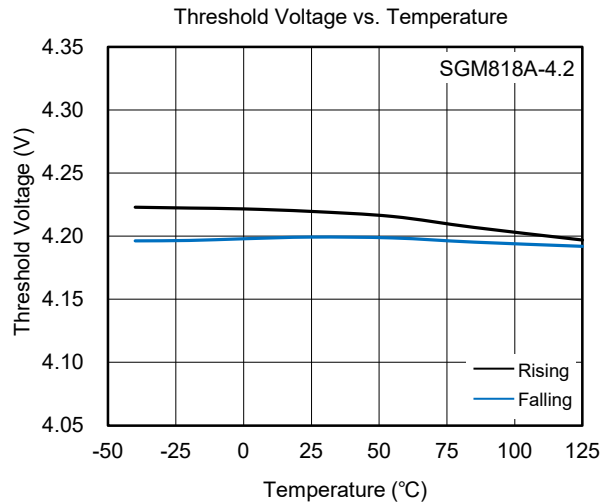
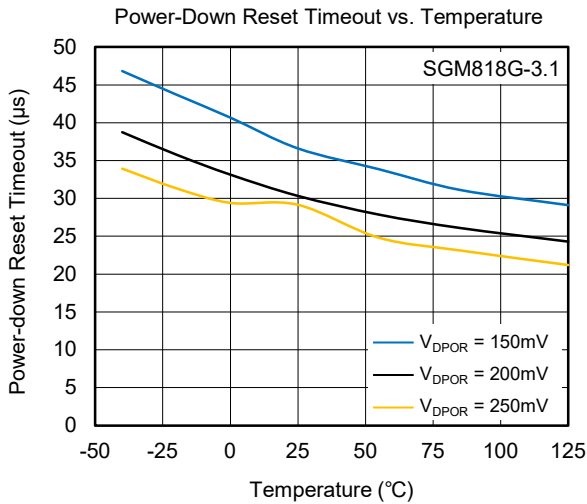
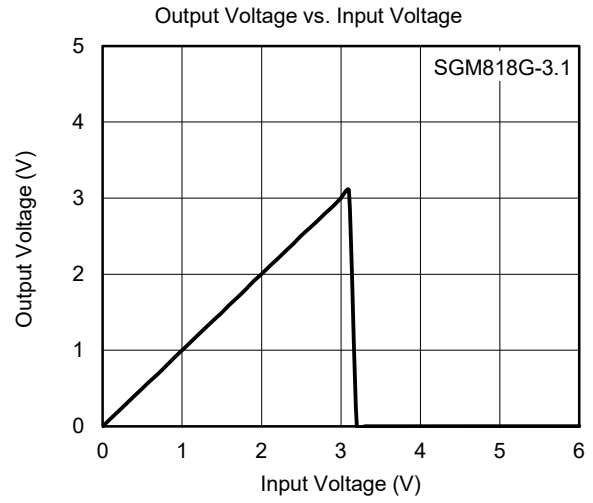
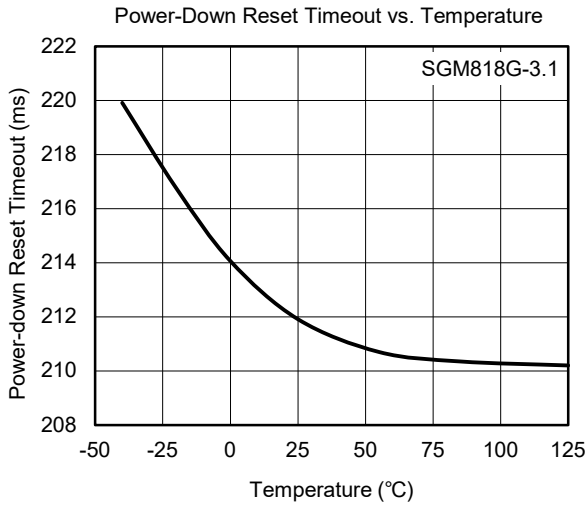

FUNCTIONAL BLOCK DIAGRAM

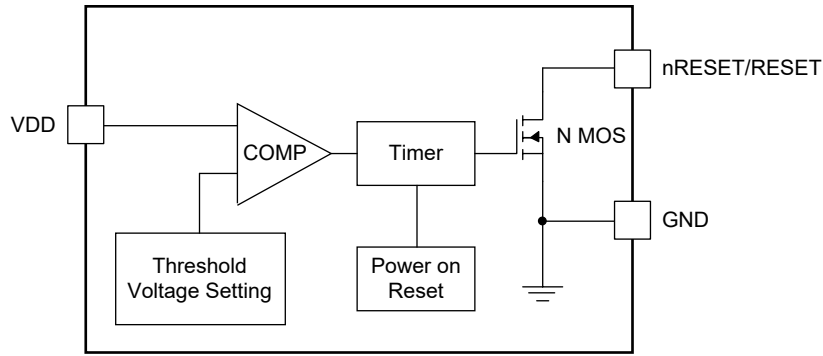

Figure 3. Block Diagram

APPLICATION INFORMATION

Multiple Supplies

The pull-up resistor connected to the SGM818 will connect to the supply voltage monitored on the VDD pin of the IC. However, the systems using open-drain output can level-shift the monitored supply voltages into the reset circuit powered by some other supply.

High Accuracy of the Reset Threshold

The reset threshold voltages of most μ P supervisor ICs are 1% to 1.5% lower than the nominal supply voltages. If the voltage is within 1% of the nominal supply, the reset will not assert, and if the voltage is within 1.5% of the nominal supply, the reset will assert.

REVISION HISTORY

NOTE: Page numbers for previous revisions may differ from page numbers in the current version.

JULY 2023 – REV.A to REV.A.1	Page
Changed Electrical Characteristics section	23
Changes from Original (MAY 2022) to REV.A	Page
Changed from product preview to production data.....	All

PACKAGE OUTLINE DIMENSIONS

SOT-23-3

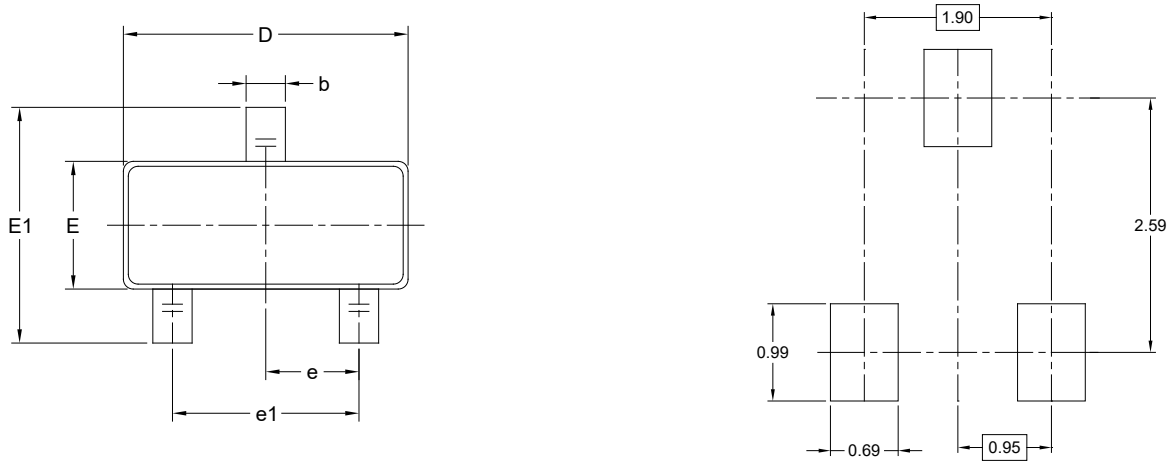

RECOMMENDED LAND PATTERN (Unit: mm)

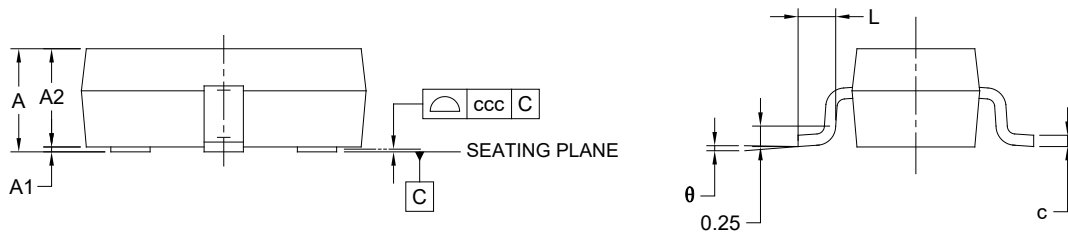

Symbol	Dimensions In Millimeters		
	MIN	MOD	MAX
A	-	-	1.450
A1	0.000	-	0.150
A2	0.900	-	1.300
b	0.300	-	0.500
c	0.080	-	0.220
D	2.750	-	3.050
E	1.450	-	1.750
E1	2.600	-	3.000
e	0.950 BSC		
e1	1.900 BSC		
L	0.300	-	0.600
θ	0°	-	8°
ccc	0.100		

NOTES:

1. This drawing is subject to change without notice.
2. The dimensions do not include mold flashes, protrusions or gate burrs.
3. Reference JEDEC MO-178.

PACKAGE INFORMATION

TAPE AND REEL INFORMATION

REEL DIMENSIONS



TAPE DIMENSIONS



NOTE: The picture is only for reference. Please make the object as the standard.

KEY PARAMETER LIST OF TAPE AND REEL

Package Type	Reel Diameter	Reel Width W1 (mm)	A0 (mm)	B0 (mm)	K0 (mm)	P0 (mm)	P1 (mm)	P2 (mm)	W (mm)	Pin1 Quadrant
SOT-23-3	7"	9.0	3.20	3.30	1.30	4.0	4.0	2.0	8.0	Q3

000001

PACKAGE INFORMATION

CARTON BOX DIMENSIONS



NOTE: The picture is only for reference. Please make the object as the standard.

KEY PARAMETER LIST OF CARTON BOX

Reel Type	Length (mm)	Width (mm)	Height (mm)	Pizza/Carton
7" (Option)	368	227	224	8
7"	442	410	224	18

DD0002