

GENERAL DESCRIPTION

The SGM8431-1Q is a single, rail-to-rail input and output, high voltage and high output drive CMOS operational amplifier for automotive applications. The device is optimized for high voltage operation from 4.5V to 36V single supply. It is capable of providing an output current of 400mA_{P-P} (MIN).

The SGM8431-1Q is specifically designed for resolver excitation applications for motor driver in hybrid and electric vehicles, which require high voltage and high output current. In the application of resolver excitation, the SGM8431-1Q is used to replace the complicated driver of resolver excitation, which is built with operational amplifiers and power transistors.

The device is AEC-Q100 qualified (Automotive Electronics Council (AEC) standard Q100 Grade 1) and it is suitable for automotive applications.

The SGM8431-1Q is available in a Green TO-252-5 package. It is specified over the extended -40°C to +125°C temperature range.

FEATURES

- AEC-Q100 Qualified for Automotive Applications
Device Temperature Grade 1
 $T_A = -40^{\circ}\text{C}$ to $+125^{\circ}\text{C}$
- High Output Current: $\pm 200\text{mA}$ (MIN)
- Rail-to-Rail Input and Output
- Supply Voltage Range: 4.5V to 36V
- Supply Current: 10mA (TYP)
- Input Bias Current: $\pm 250\text{pA}$ (MAX) at $+25^{\circ}\text{C}$
- Open-Loop Voltage Gain: 106dB (TYP)
- Unity-Gain Frequency: 4.5MHz (TYP)
- Slew Rate: $3.5\text{V}/\mu\text{s}$ (TYP)
- Thermal Shutdown
- Current-Limit Protection
- Available in a Green TO-252-5 Package

APPLICATIONS

- Automotive Application
- Driver of Resolver Excitation
- Motor Driver
- Speaker Driver
- 4mA-to-20mA Transmitter

TYPICAL APPLICATION

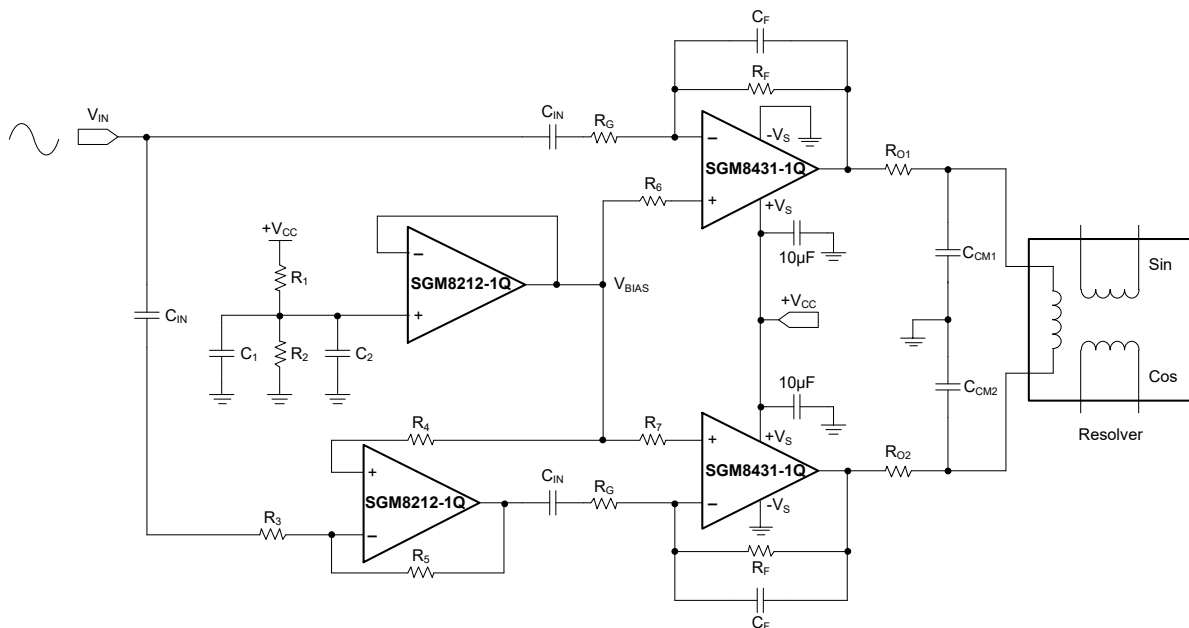

Figure 1. Resolver Excitation Circuit

Automotive, High Output Current, Rail-to-Rail SGM8431-1Q I/O, Single CMOS Operational Amplifier

PACKAGE/ORDERING INFORMATION

MODEL	PACKAGE DESCRIPTION	SPECIFIED TEMPERATURE RANGE	ORDERING NUMBER	PACKAGE MARKING	PACKING OPTION
SGM8431-1Q	TO-252-5	-40°C to +125°C	SGM8431-1QOF5G/TR	0RROF5 XXXXX	Tape and Reel, 2500

MARKING INFORMATION

NOTE: XXXXX = Date Code, Trace Code and Vendor Code.

XXXXX

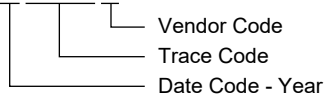

Green (RoHS & HSF): SG Micro Corp defines "Green" to mean Pb-Free (RoHS compatible) and free of halogen substances. If you have additional comments or questions, please contact your SGMICRO representative directly.

ABSOLUTE MAXIMUM RATINGS

Supply Voltage, $+V_S$ to $-V_S$	40V
Differential Input Voltage ⁽¹⁾ , V_{ID}	$\pm V_S$
Input Voltage Range, V_{IN}	$(-V_S) - 0.3V$ to $(+V_S) + 0.3V$
Input Current, I_{IN}	$\pm 10mA$ ⁽²⁾
Output Terminal Input Voltage, V_{OUT}	$(-V_S) - 0.3V$ to $(+V_S) + 0.3V$
Package Thermal Resistance	
TO-252-5, θ_{JA}	43.7°C/W
TO-252-5, θ_{JB}	11.7°C/W
TO-252-5, θ_{JC}	40°C/W
TO-252-5, $\theta_{JC(BOT)}$	6.3°C/W
Junction Temperature	+150°C
Storage Temperature Range	-65°C to +150°C
Lead Temperature (Soldering, 10s)	+260°C
ESD Susceptibility	
HBM	5000V
CDM	1000V

NOTES:

- Differential voltages are at +IN, with respect to -IN.
- A restriction resistor is used to limit the input current to less than 10mA if the input voltage is higher than the supply voltage.

RECOMMENDED OPERATING CONDITIONS

Supply Voltage Range ⁽¹⁾	4.5V to 36V
Operating Temperature Range	-40°C to +125°C

NOTE:

- If the output is shorted to ground or supply when supply voltage exceeds 30V, the SGM8431-1Q may be damaged. Do not operate the device continuously in a thermal shutdown state for a long time, as this operation may cause irreversible damage to the device.

OVERSTRESS CAUTION

Stresses beyond those listed in Absolute Maximum Ratings may cause permanent damage to the device. Exposure to absolute maximum rating conditions for extended periods may affect reliability. Functional operation of the device at any conditions beyond those indicated in the Recommended Operating Conditions section is not implied.

ESD SENSITIVITY CAUTION

This integrated circuit can be damaged if ESD protections are not considered carefully. SGMICRO recommends that all integrated circuits be handled with appropriate precautions. Failure to observe proper handling and installation procedures can cause damage. ESD damage can range from subtle performance degradation to complete device failure. Precision integrated circuits may be more susceptible to damage because even small parametric changes could cause the device not to meet the published specifications.

DISCLAIMER

SG Micro Corp reserves the right to make any change in circuit design, or specifications without prior notice.

PIN CONFIGURATION

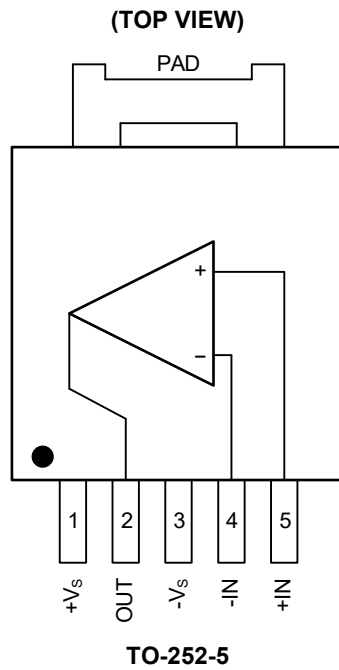

NOTE: The PAD should be connected to $-V_s$, and the wiring must be as short as possible.

Automotive, High Output Current, Rail-to-Rail I/O, Single CMOS Operational Amplifier

SGM8431-1Q

ELECTRICAL CHARACTERISTICS

($V_S = 4.5V$ to $36V$, $V_{CM} = V_S/2$, $R_L = 10k\Omega$ to $V_S/2$, Full = $-40^\circ C$ to $+125^\circ C$, typical values are at $T_A = +25^\circ C$, unless otherwise noted.)

PARAMETER	SYMBOL	CONDITIONS	TEMP	MIN	TYP	MAX	UNITS
Input Characteristics							
Input Offset Voltage	V_{OS}		+25°C		±1	±6	mV
			Full			±8	
Input Offset Voltage Drift	$\Delta V_{OS}/\Delta T$		Full		4		$\mu V/^\circ C$
Input Bias Current	I_B		+25°C		±10	±250	pA
			Full			±36	nA
Input Offset Current	I_{OS}		+25°C		±10	±250	pA
			Full			±25	nA
Input Common Mode Voltage Range	V_{CM}	CMRR $\geq 55dB$	Full	0		V_S	V
Common Mode Rejection Ratio	CMRR	$V_S = 4.5V, V_{CM} = 0V$ to $4.5V$	+25°C	60	78		dB
			Full	57			
		$V_S = 12V, V_{CM} = 0V$ to $12V$	+25°C	68	86		
			Full	65			
		$V_S = 12V, V_{CM} = 0V$ to $10V$	+25°C	74	100		
			Full	70			
Open-Loop Voltage Gain	A_V	$V_{OUT} = (-V_S) + 1V$ to $(+V_S) - 1V$	+25°C	98	106		dB
			Full	92			
Output Characteristics							
Output Voltage	V_{OH}	$V_S = 36V$	+25°C		10	25	mV
			Full			30	
		$V_S = 36V, I_{SOURCE} = 200mA$	+25°C		330	600	
			Full			800	
	V_{OL}	$V_S = 36V$	+25°C		10	25	
			Full			30	
$V_S = 36V, I_{SINK} = 200mA$		+25°C		290	600		
		Full			800		
Output Source Current Limit	$I_{SOURCE LIM}$		+25°C	230	350	450	mA
			Full	220		480	
Output Sink Current Limit	$I_{SINK LIM}$		+25°C	220	300	420	mA
			Full	200		450	
Power Supply							
Supply Current	I_Q	$G = +1$, no signal, $R_L = open$	+25°C		10	16	mA
			Full			17	
Power Supply Rejection Ratio	PSRR	$V_{CM} = 2.25V$	+25°C	106	114		dB
			Full	103			

Automotive, High Output Current, Rail-to-Rail I/O, Single CMOS Operational Amplifier

SGM8431-1Q

ELECTRICAL CHARACTERISTICS (continued)

($V_S = 12V$, $V_{CM} = V_S/2$, $R_L = 10k\Omega$ to $V_S/2$, Full = $-40^\circ C$ to $+125^\circ C$, typical values are at $T_A = +25^\circ C$, unless otherwise noted.)

PARAMETER	SYMBOL	CONDITIONS	TEMP	MIN	TYP	MAX	UNITS
Dynamic Performance							
Unity-Gain Frequency	f_T	$C_L = 50pF$	$+25^\circ C$		4.5		MHz
Phase Margin	ϕ_O	$C_L = 50pF$	$+25^\circ C$		75		$^\circ$
Slew Rate ⁽¹⁾	SR	$G = +1$, $C_L = 50pF$, $V_{IN} = 4V_{P-P}$	Full	2	3.5		$V/\mu s$
Settling Time to 0.1%	t_s	$G = -1$, $C_L = 50pF$, $V_{IN} = 4V_{P-P}$ (4V to 8V)	$+25^\circ C$		4		μs
Overload Recovery Time	ORT	$G = -10$, $C_L = 50pF$, $V_{IN} \times G_V > V_S$	$+25^\circ C$		1		μs
Noise Performance							
Equivalent Input Noise Voltage	e_n	$f = 10kHz$	$+25^\circ C$		30		nV/\sqrt{Hz}
Total Harmonic Distortion + Noise	THD+N	$G = +2$, $V_{OUT} = 2V_{P-P}$, $f = 10kHz$	$+25^\circ C$		0.03		%
Thermal Protection							
Thermal Shutdown Temperature	T_{SHDN}				170		$^\circ C$
Thermal Shutdown Hysteresis	ΔT_{SHDN}				20		$^\circ C$

NOTE: 1. Specified by design and characterization, not production tested.

SGM8431-1Q Automotive, High Output Current, Rail-to-Rail I/O, Single CMOS Operational Amplifier

TYPICAL PERFORMANCE CHARACTERISTICS

At $T_A = +25^\circ\text{C}$, $V_S = 12\text{V}$, $V_{CM} = V_S/2$, $R_L = 10\text{k}\Omega$ to $V_S/2$, unless otherwise noted.

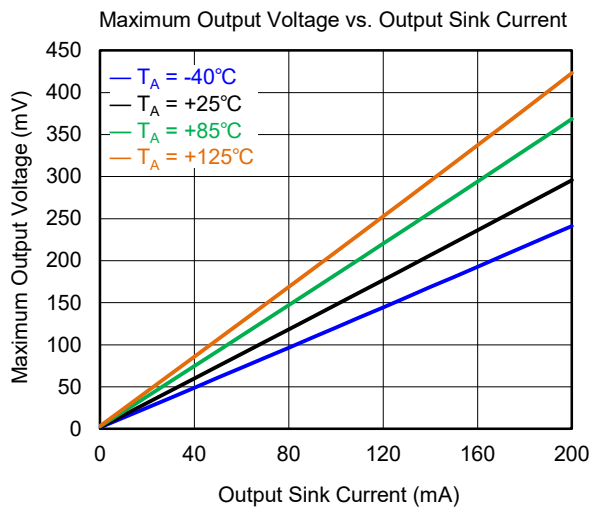
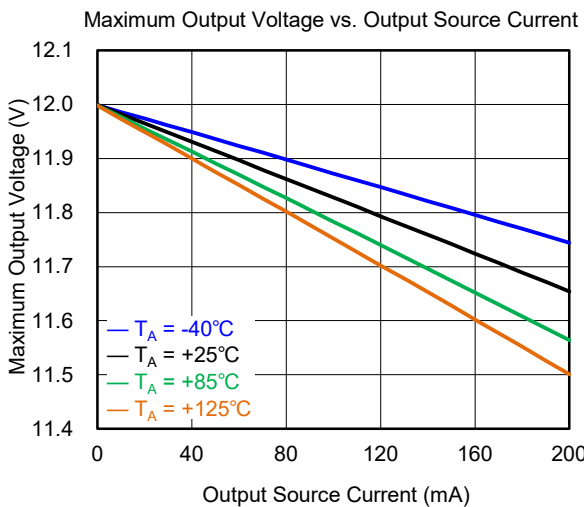
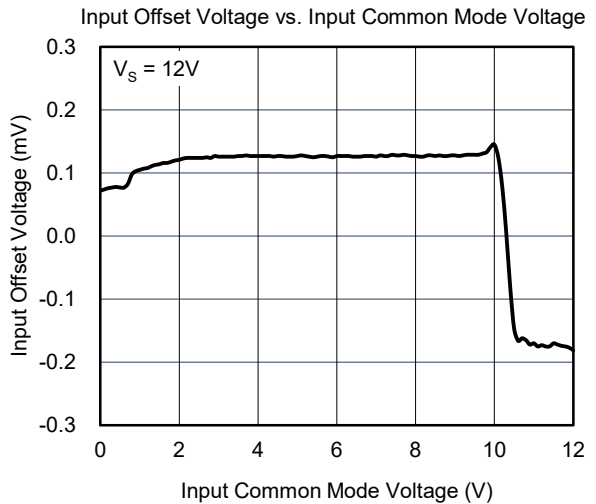
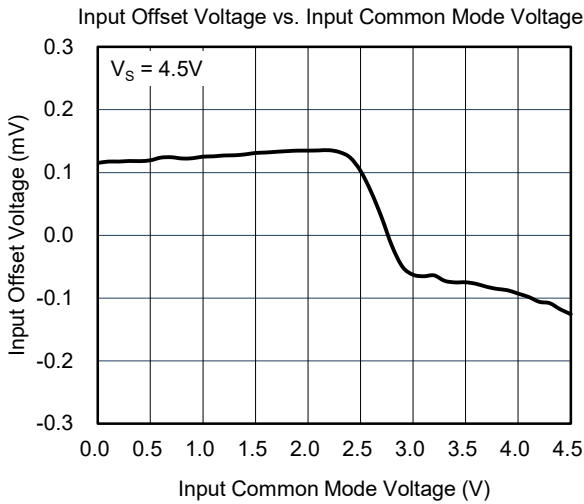
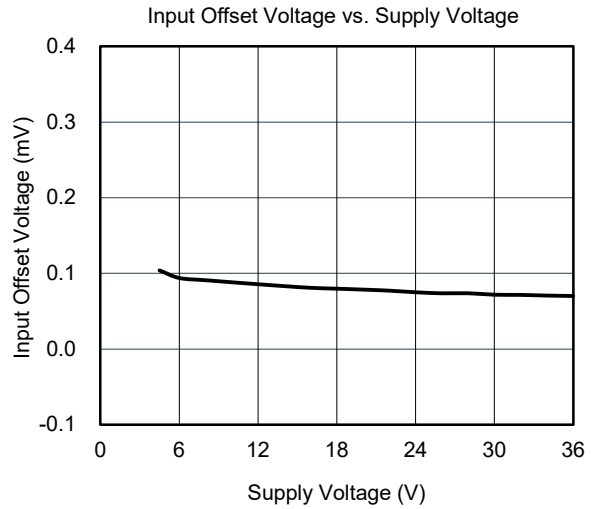
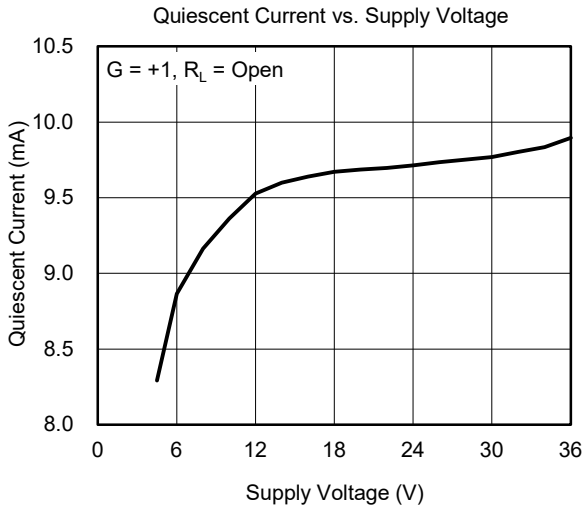

Automotive, High Output Current, Rail-to-Rail I/O, Single CMOS Operational Amplifier

SGM8431-1Q

TYPICAL PERFORMANCE CHARACTERISTICS (continued)

At $T_A = +25^\circ\text{C}$, $V_S = 12\text{V}$, $V_{CM} = V_S/2$, $R_L = 10\text{k}\Omega$ to $V_S/2$, unless otherwise noted.

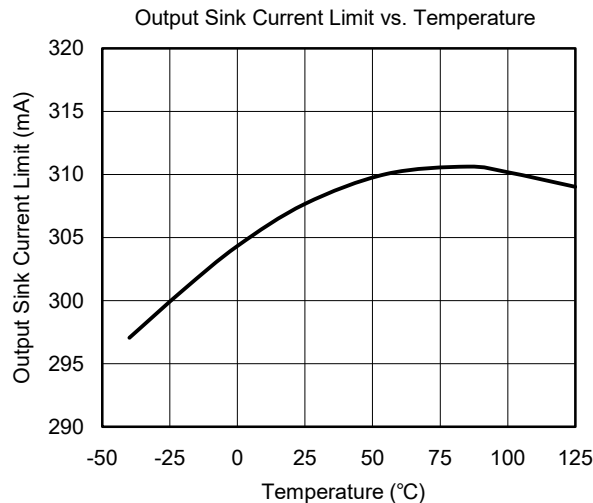
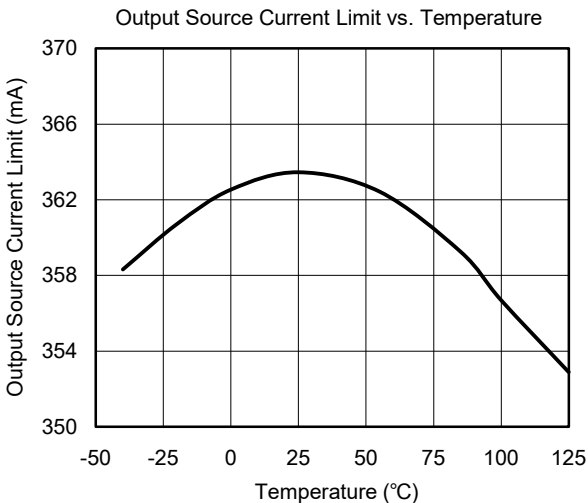
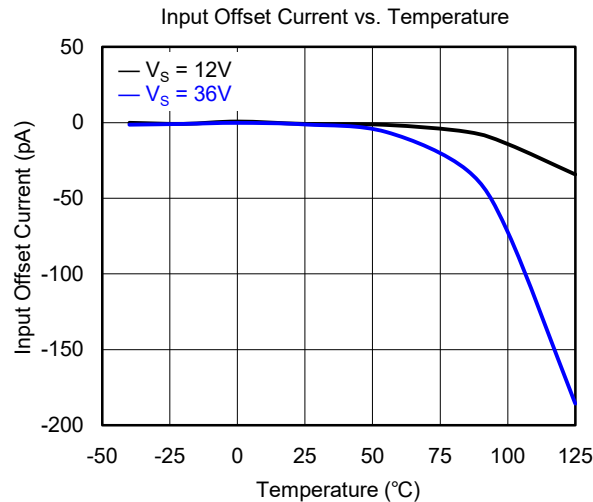
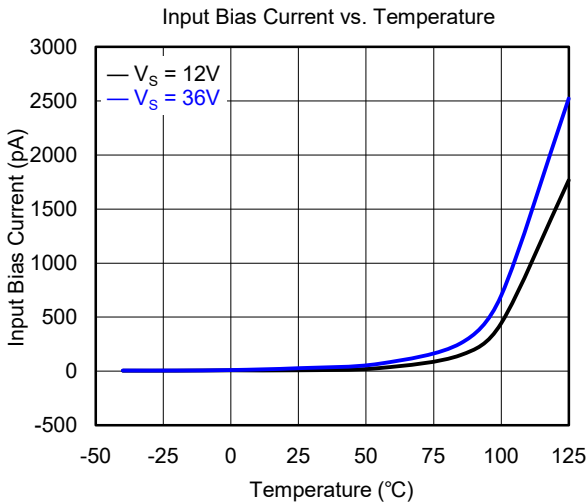
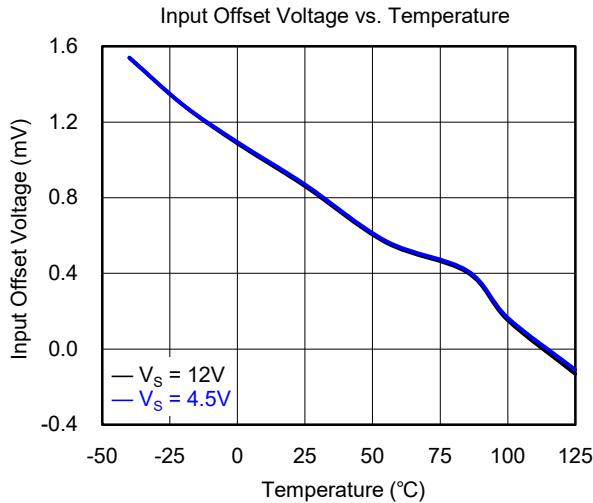
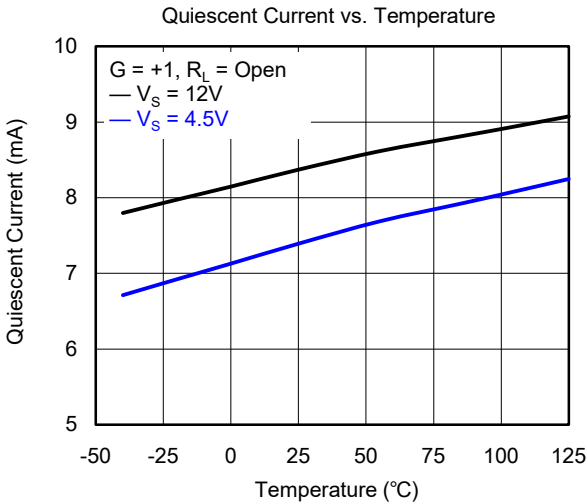

SGM8431-1Q Automotive, High Output Current, Rail-to-Rail I/O, Single CMOS Operational Amplifier

TYPICAL PERFORMANCE CHARACTERISTICS (continued)

At $T_A = +25^\circ\text{C}$, $V_S = 12\text{V}$, $V_{CM} = V_S/2$, $R_L = 10\text{k}\Omega$ to $V_S/2$, unless otherwise noted.

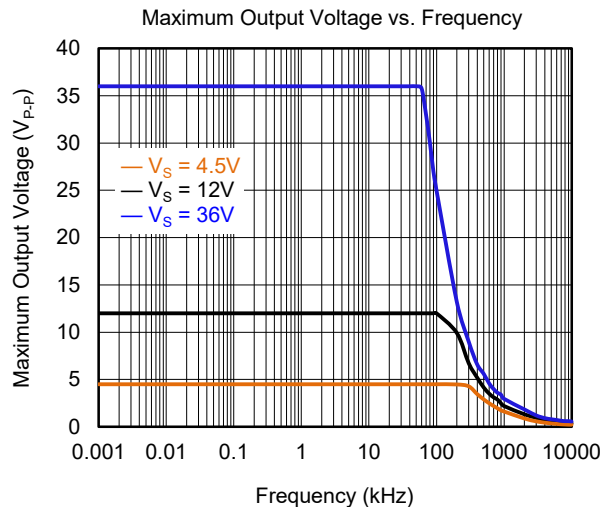
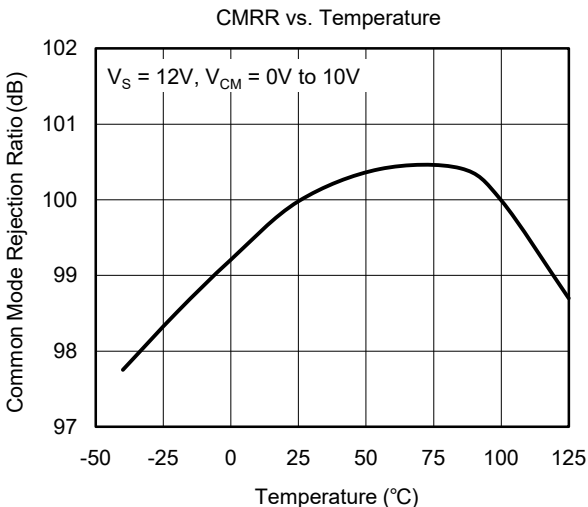
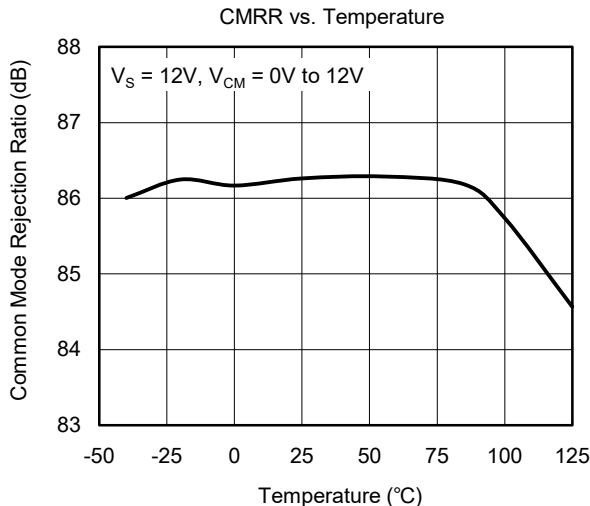
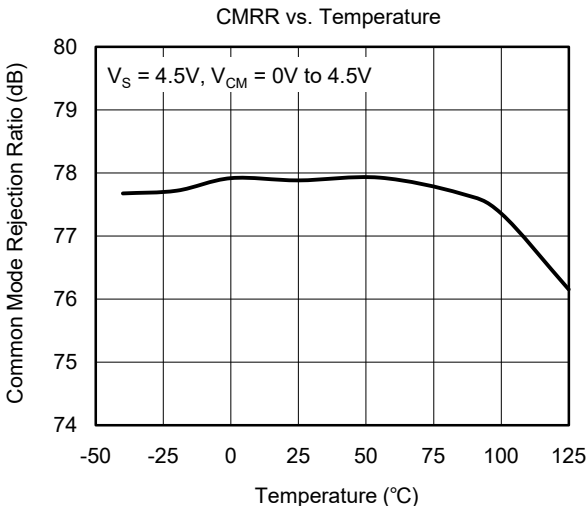
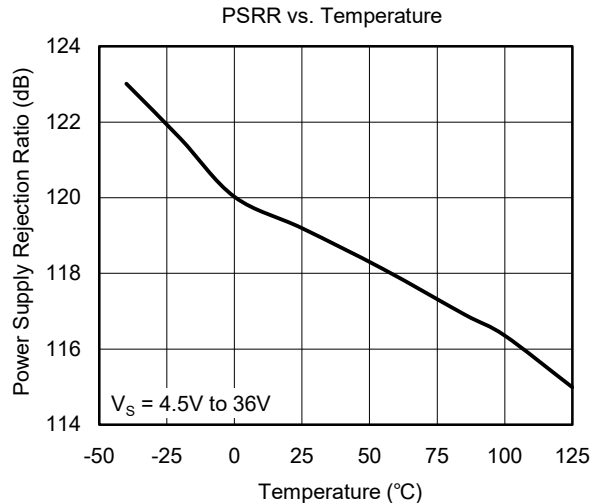
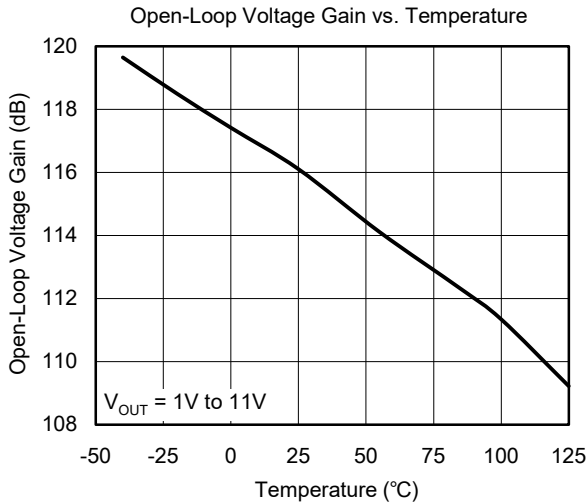

SGM8431-1Q Automotive, High Output Current, Rail-to-Rail I/O, Single CMOS Operational Amplifier

TYPICAL PERFORMANCE CHARACTERISTICS (continued)

At $T_A = +25^\circ\text{C}$, $V_S = 12\text{V}$, $V_{CM} = V_S/2$, $R_L = 10\text{k}\Omega$ to $V_S/2$, unless otherwise noted.

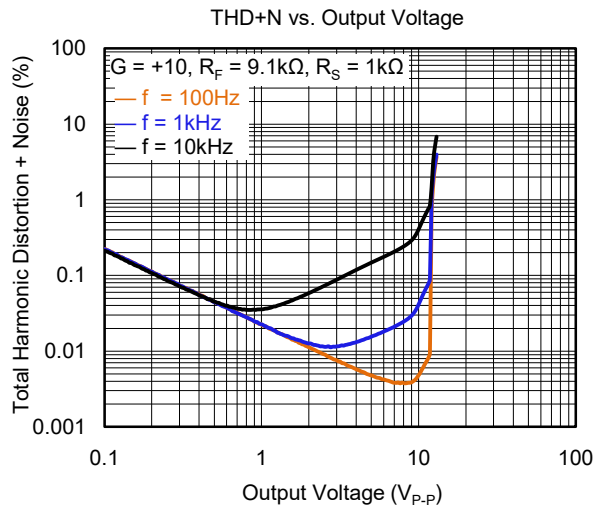
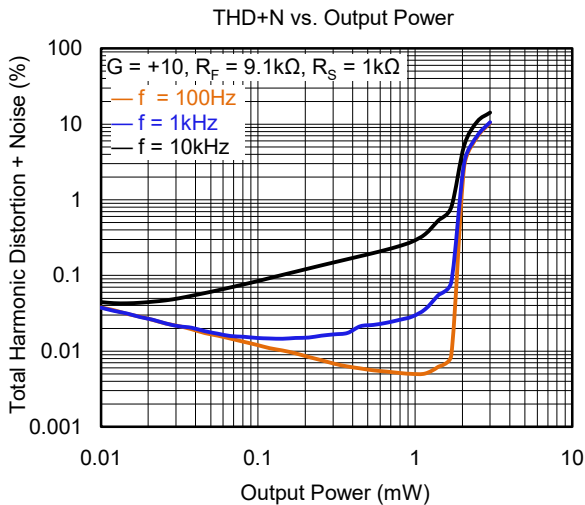
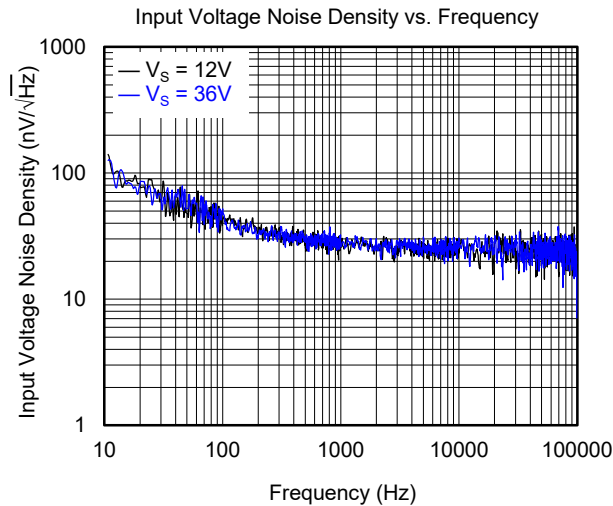
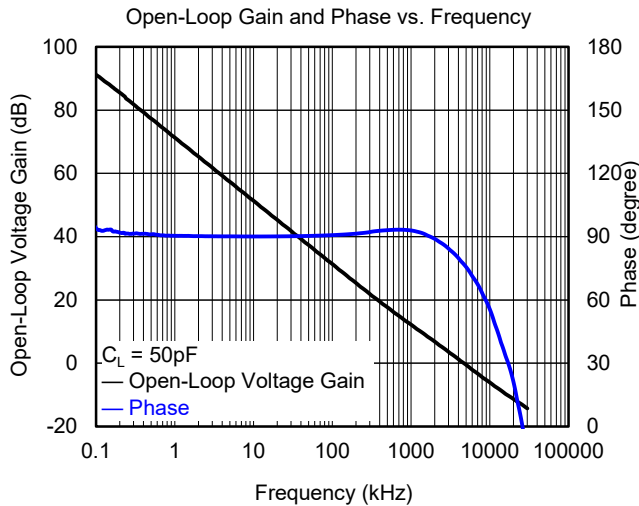
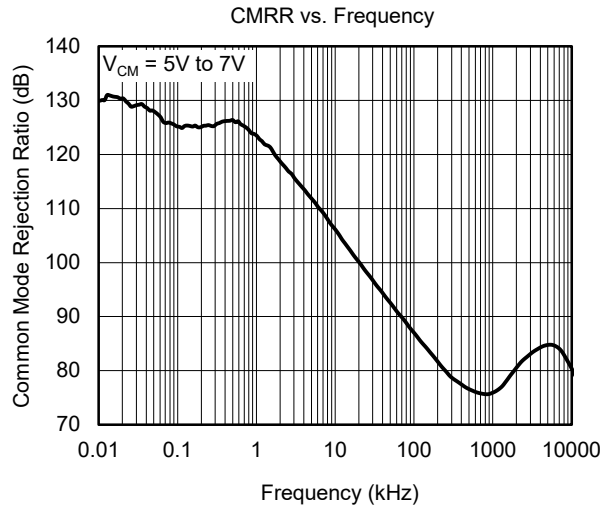
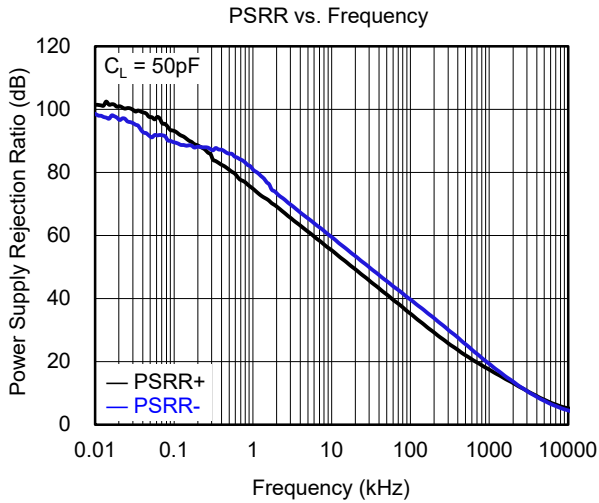

SGM8431-1Q Automotive, High Output Current, Rail-to-Rail I/O, Single CMOS Operational Amplifier

TYPICAL PERFORMANCE CHARACTERISTICS (continued)

At $T_A = +25^\circ\text{C}$, $V_S = 12\text{V}$, $V_{CM} = V_S/2$, $R_L = 10\text{k}\Omega$ to $V_S/2$, unless otherwise noted.

Large-Signal Step Response

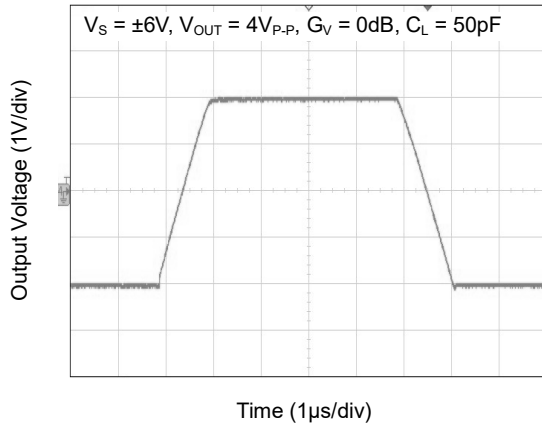

No Phase Reversal

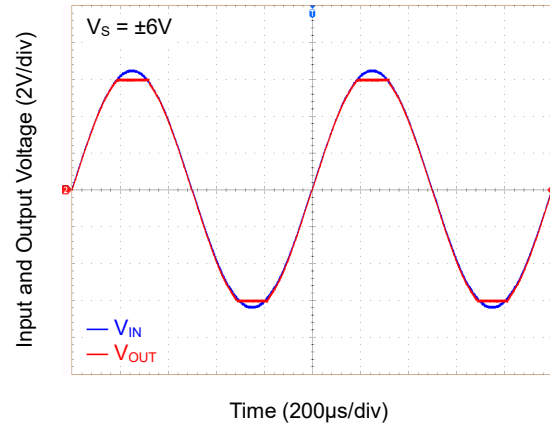

SGM8431-1Q Automotive, High Output Current, Rail-to-Rail I/O, Single CMOS Operational Amplifier

APPLICATION INFORMATION

The SGM8431-1Q is a single CMOS operational amplifier featuring rail-to-rail input and output, high voltage, and high output drive. It operates within a wide voltage range of 4.5V to 36V, offers a high continuous output current of 200mA (MIN), and is available in a TO-252-5 package that provides efficient heat dissipation. These characteristics make the SGM8431-1Q highly suitable for applications requiring both high operating voltage and high output current.

The SGM8431-1Q has output current limit and thermal shutdown (TSD) functions. It can be flexibly applied to a resolver excitation circuit. The following chapters provide more detailed descriptions.

Current Limit

The SGM8431-1Q design has an output current limit function that activates when overload events happen. The output source and sink current limits are 350mA (TYP) and 300mA (TYP), respectively.

In application, the die temperature rises rapidly if the SGM8431-1Q is in current limitation for a long time. This situation may cause the chip to enter thermal shutdown. Therefore, it is necessary for users to evaluate whether the SGM8431-1Q's output current can meet the normal operating requirements when designing circuits.

Thermal Shutdown

The SGM8431-1Q design has a thermal shutdown (TSD) function. The device will enter shutdown state when the internal junction temperature exceeds the shutdown threshold of +170°C. In thermal shutdown mode, the output current is cut off, and the output pin remains in a high impedance state. The SGM8431-1Q's thermal shutdown hysteresis temperature is 20°C. The device will automatically recover from the TSD mode once the junction temperature drops to +150°C.

In application, the SGM8431-1Q should be operated at a junction temperature below +150°C, and the thermal PAD should be connected to a larger ground plane to maximize the thermal performance.

Resolver Excitation Circuit

The SGM8431-1Q's high continuous output current function makes it very suitable for resolver excitation circuit. Figure 2 shows the typical resolver excitation circuit using the SGM8431-1Q and the SGM8212-1Q. This circuit includes two SGM8212-1Qs: one is used to provide a bias voltage buffer and the other is used as an inverting amplifier to obtain a signal with phase reversal.

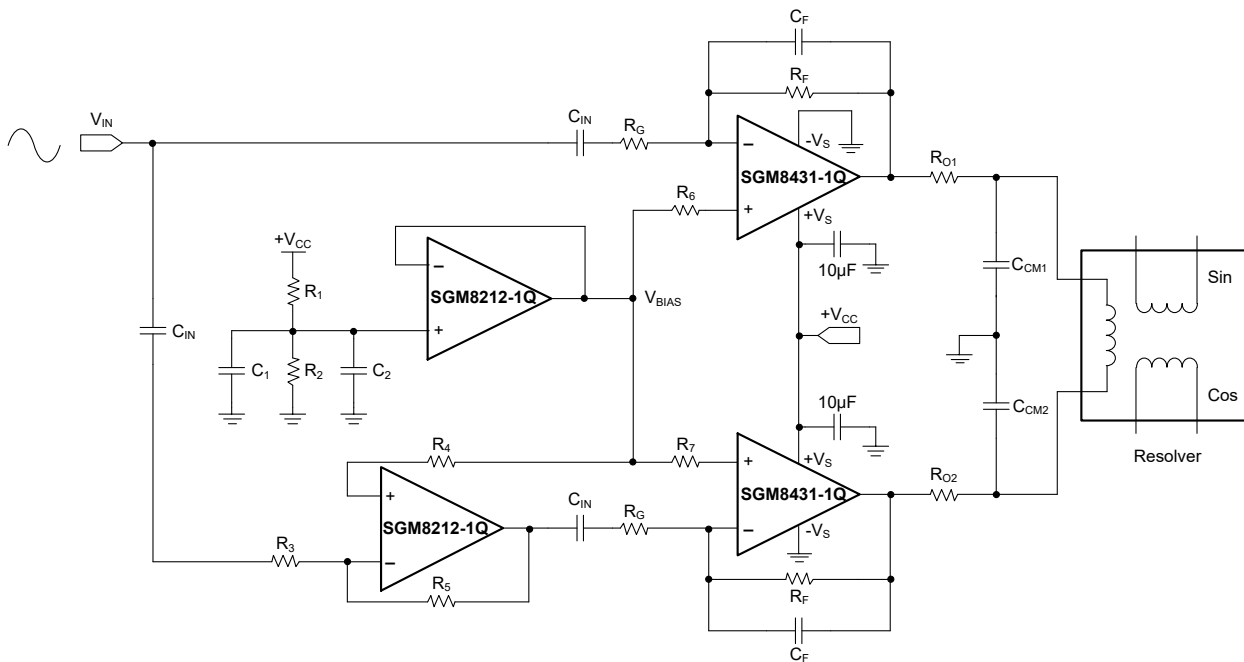

Figure 2. Resolver Excitation Circuit with SGM8212-1Q

Automotive, High Output Current, Rail-to-Rail I/O, Single CMOS Operational Amplifier

SGM8431-1Q

APPLICATION INFORMATION (continued)

Figure 3 shows a simplified resolver excitation circuit without SGM8212-1Q. Its bias voltage is provided by a resistance voltage divider, and the input signal is a differential signal with a phase difference of 180 degrees.

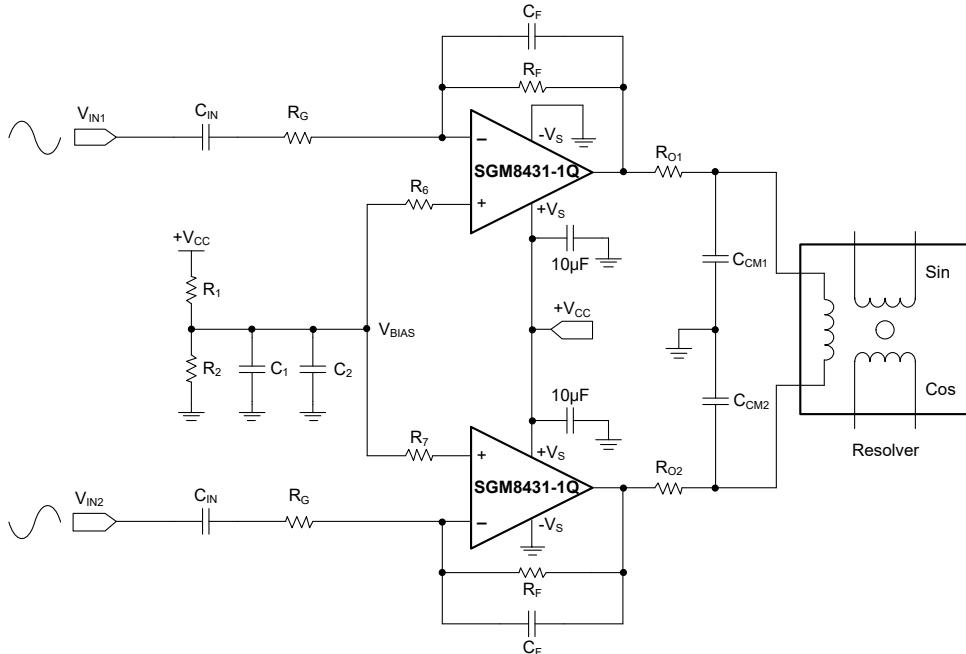

Figure 3. Simplified Resolver Excitation Circuit without SGM8212-1Q

Figure 4 shows a resolver excitation circuit with a pulse-width modulation (PWM) signal as the input. In this circuit, the SGM8212-1Q is used as a buffer and provides the bias voltage. Two input PWM signals from the I/O pins of the microcontroller are filtered by a two-stage RC filter circuit and converted to a sine wave signal for use as an excitation input.

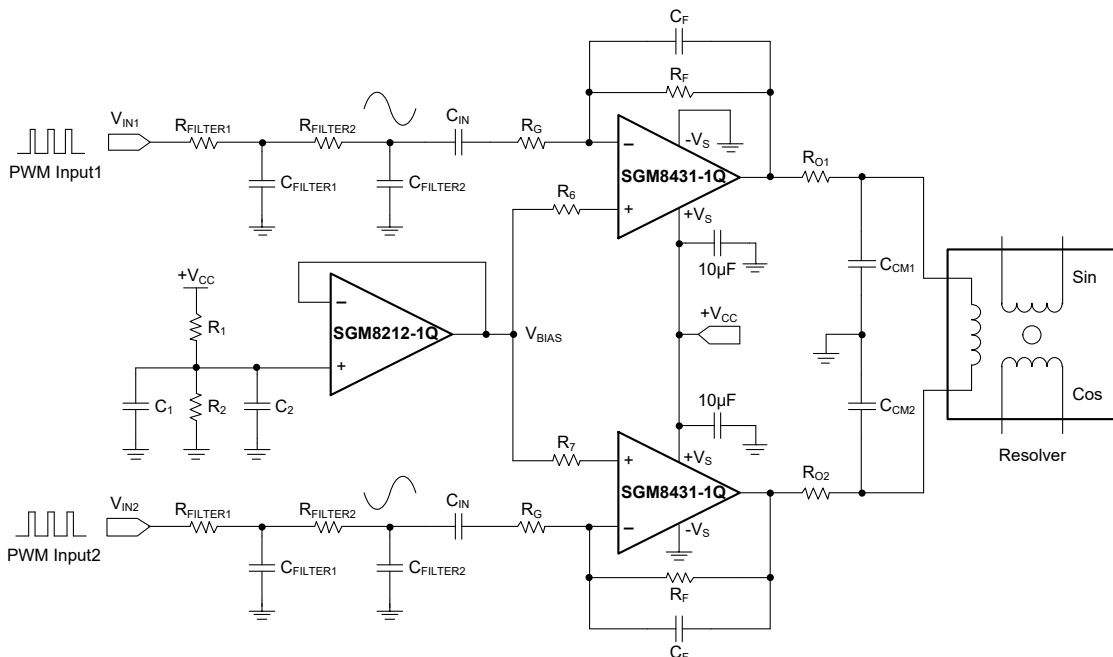

Figure 4. Resolver Excitation Circuit from PWM Input Signal

APPLICATION INFORMATION (continued)

Figure 5 shows the actual output waveform from a resolver excitation circuit, and the key circuit parameter design is shown in Table 1.

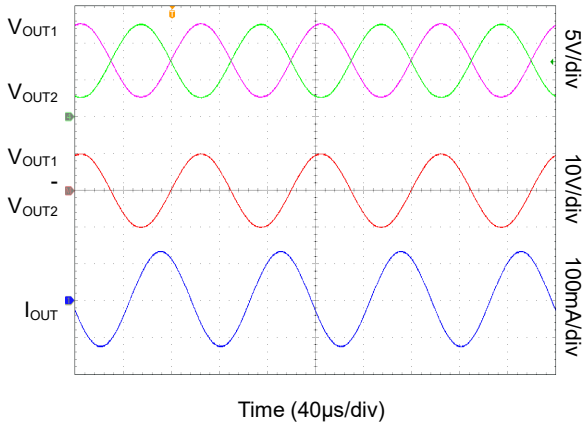

Figure 5. Actual Output Waveform from Resolver Excitation Circuit (+V_S = 15V, -V_S = 0V, f = 10kHz)

Table 1. Design Parameters

Design Parameter	Example Value
Ambient Temperature Range	-40°C to +125°C
Supply Voltage	+15V
V _{BIAS}	+7.5V from SGM8212-1Q
R _O And C _{CM}	0Ω and 3nF
Gain	2.5V/V
Input Signal Frequency	10kHz
Resolver Excitation Input Voltage	8V _{P-P}
Resolver Excitation Output Voltage	20V _{P-P}
Output Current with Resolver Equivalent Circuit	±130mA _{P-P}

Figure 6 and Figure 7 respectively show the output voltage and the output current of the resolver excitation circuit.

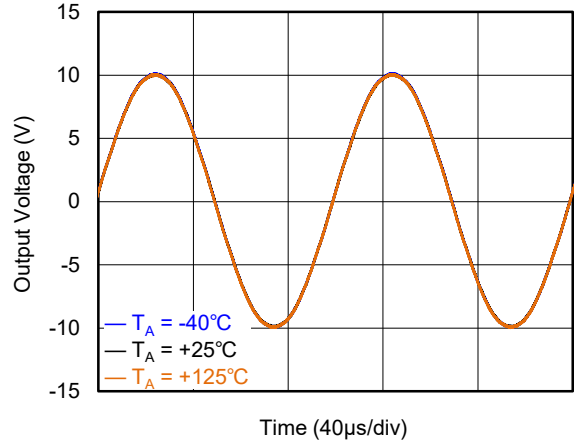

Figure 6. Output Voltage of Resolver Excitation Circuit

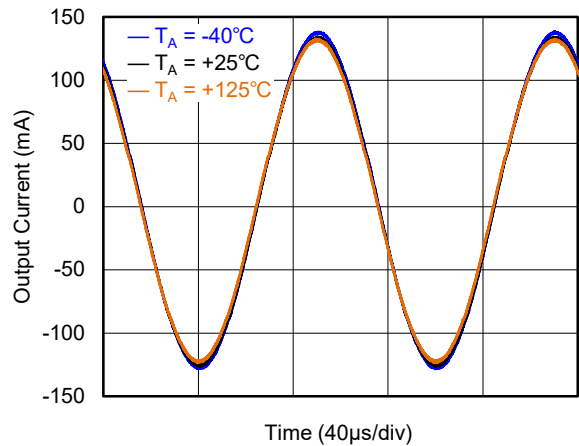

Figure 7. Output Current of Resolver Excitation Circuit

REVISION HISTORY

NOTE: Page numbers for previous revisions may differ from page numbers in the current version.

Changes from Original (JUNE 2024) to REV.A	Page
Changed from product preview to production data.....	All

PACKAGE OUTLINE DIMENSIONS

TO-252-5

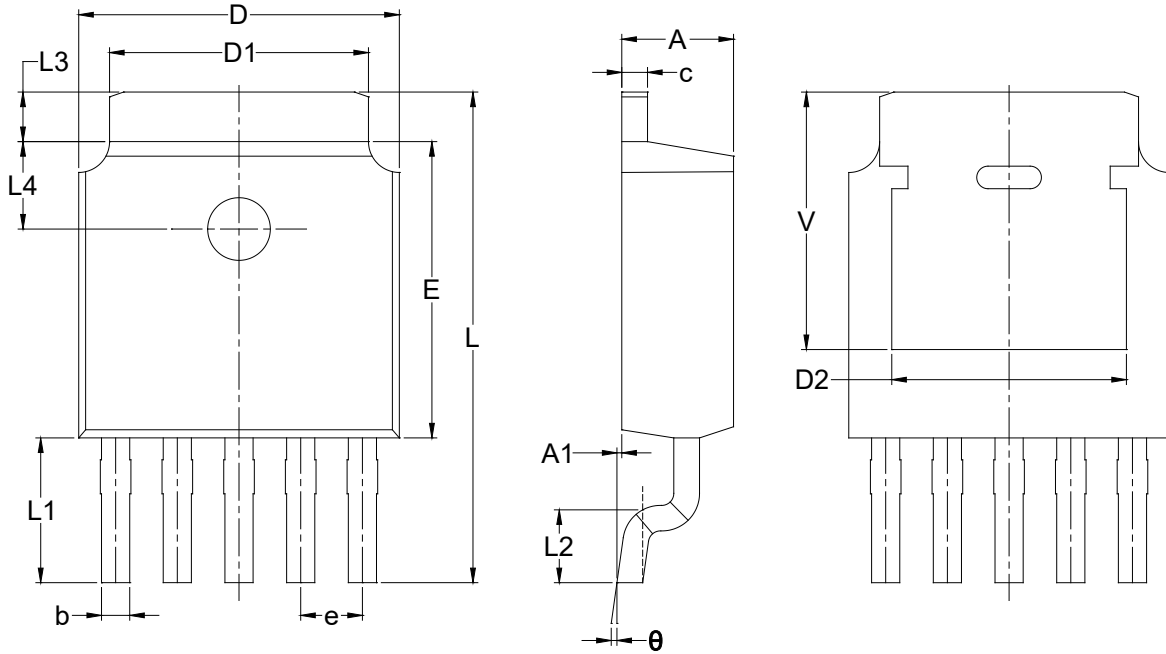

Symbol	Dimensions In Millimeters		
	MIN	MOD	MAX
A	2.184	-	2.400
A1	0.000	-	0.127
b	0.508	-	0.711
c	0.457	-	0.889
D	6.350	-	6.731
D1	5.330 REF		
D2	4.830 REF		
E	5.969	-	6.223
e	1.270 BSC		
L	9.398	-	10.414
L1	2.980 REF		
L2	1.397	-	1.778
L3	1.020 REF		
L4	1.800 REF		
V	5.300 REF		
θ	0°	-	10°

- NOTES:
 1. This drawing is subject to change without notice.
 2. The dimensions do not include mold flashes, protrusions or gate burrs.

PACKAGE INFORMATION

TAPE AND REEL INFORMATION

REEL DIMENSIONS



TAPE DIMENSIONS



NOTE: The picture is only for reference. Please make the object as the standard.

KEY PARAMETER LIST OF TAPE AND REEL

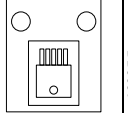
Package Type	Reel Diameter	Reel Width W1 (mm)	A0 (mm)	B0 (mm)	K0 (mm)	P0 (mm)	P1 (mm)	P2 (mm)	W (mm)	Pin1 Quadrant
TO-252-5	13"	16.4	6.90	10.50	2.85	4.0	8.0	2.0	16.0	

D30001

PACKAGE INFORMATION

CARTON BOX DIMENSIONS



NOTE: The picture is only for reference. Please make the object as the standard.

KEY PARAMETER LIST OF CARTON BOX

Reel Type	Length (mm)	Width (mm)	Height (mm)	Pizza/Carton
13"	386	280	370	5

DD0002