



SGM4822/SGM4823/SGM4825/SGM4826 Single/Dual-Input, Fixed-Gain Microphone Amplifiers with Integrated Bias

GENERAL DESCRIPTION

The SGM4822/SGM4825 (single-input) and SGM4823/SGM4826 (dual-input) are low noise, low power, rail-to-rail, fixed-gain microphone amplifiers with integrated bias. The SGM4822/SGM4823 support power supply voltage from 3.3V to 5.5V and the SGM4825/SGM4826 support wide power supply voltage from 2.7V to 5.5V. The devices are suitable for portable audio applications. They feature low THD+N = 0.009% in active mode, 2.6MHz bandwidth and forced shutdown mode.

The SGM4822/SGM4823 power-saving features include automatic switching between low power monitor mode and low noise active mode, and the devices also provide latched push-pull output to wake up external MCU in sleeping mode. Two inputs of the SGM4823/SGM4826 allow two microphones to be multiplexed into one output.

The devices operate over an ambient temperature range of -40°C to +85°C.

FEATURES

- **Very Low Noise: $30\text{nV}/\sqrt{\text{Hz}}$ at 1kHz, Gain = 20dB**
- **Very Low THD+N: 0.009%, Gain = 20dB**
- **Wide Supply Voltage Range:**
 - **3.3V to 5.5V (SGM4822/SGM4823)**
 - **2.7V to 5.5V (SGM4825/SGM4826)**
- **Low Quiescent Current:**
 - **0.1 μA in Forced Shutdown Mode (SGM4822/SGM4823)**
 - **4 μA in Monitor Mode at $V_{\text{CC}} = 3.3\text{V}$**
 - **660 μA in Active Mode**
- **Low Noise Microphone Bias Voltage: 2.3V**
- **Rail-to-Rail Outputs**
- **20dB Fixed-Gain**
- **Automatic Switching between Low Power Monitor Mode and Low Noise Active Mode (SGM4822/SGM4823)**
- **Latched Push-Pull Output to Wake Up External MCU in Sleeping Mode (SGM4822/SGM4823)**
- **-40°C to +85°C Operating Temperature Range**

APPLICATIONS

Laptop Computers
Smart Phones
Digital Cameras
VCRs

PACKAGE/ORDERING INFORMATION

MODEL	PACKAGE DESCRIPTION	SPECIFIED TEMPERATURE RANGE	ORDERING NUMBER	PACKAGE MARKING	PACKING OPTION
SGM4822B-23 (Gain = 20dB, V _{BIAS} = 2.3V)	SOT-23-8	-40°C to +85°C	SGM4822B-23YN8G/TR	GTBXX	Tape and Reel, 3000
SGM4823B-23 (Gain = 20dB, V _{BIAS} = 2.3V)	MSOP-10	-40°C to +85°C	SGM4823B-23YMS10G/TR	GX2 YMS10 XXXXX	Tape and Reel, 4000
SGM4825B-23 (Gain = 20dB, V _{BIAS} = 2.3V)	SOT-23-6	-40°C to +85°C	SGM4825B-23YN6G/TR	GTCXX	Tape and Reel, 3000
SGM4826B-23 (Gain = 20dB, V _{BIAS} = 2.3V)	SOT-23-8	-40°C to +85°C	SGM4826B-23YN8G/TR	GTDXX	Tape and Reel, 3000

MARKING INFORMATION

NOTE: XX = Date Code. XXXXX = Date Code and Vendor Code.

SOT-23-6/SOT-23-8

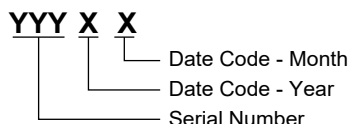

MSOP-10

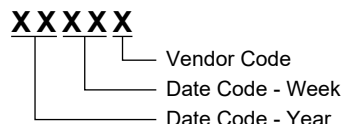

Green (RoHS & HSF): SG Micro Corp defines "Green" to mean Pb-Free (RoHS compatible) and free of halogen substances. If you have additional comments or questions, please contact your SGMICRO representative directly.

ABSOLUTE MAXIMUM RATINGS

V _{CC} to GND	-0.3V to +6V
All Other Pins	-0.3V to (V _{CC} + 0.3V)
Continuous Current (IN, IN1, IN2, $\overline{\text{SHDN}}$, WAKEUP, RESET, IN1/ $\overline{\text{IN2}}$)	±20mA
Junction Temperature	+150°C
Storage Temperature Range	-65°C to +150°C
Lead Temperature (Soldering, 10s)	+260°C
ESD Susceptibility	
HBM	2000V
MM	300V
CDM	1000V

RECOMMENDED OPERATING CONDITIONS

Supply Voltage (SGM4822/SGM4823)	3.3V to 5.5V
Supply Voltage (SGM4825/SGM4826)	2.7V to 5.5V
Operating Temperature Range	-40°C to +85°C

OVERSTRESS CAUTION

Stresses beyond those listed in Absolute Maximum Ratings may cause permanent damage to the device. Exposure to absolute maximum rating conditions for extended periods may affect reliability. Functional operation of the device at any conditions beyond those indicated in the Recommended Operating Conditions section is not implied.

ESD SENSITIVITY CAUTION

This integrated circuit can be damaged if ESD protections are not considered carefully. SGMICRO recommends that all integrated circuits be handled with appropriate precautions. Failure to observe proper handling and installation procedures can cause damage. ESD damage can range from subtle performance degradation to complete device failure. Precision integrated circuits may be more susceptible to damage because even small parametric changes could cause the device not to meet the published specifications.

DISCLAIMER

SG Micro Corp reserves the right to make any change in circuit design, or specifications without prior notice.

PIN CONFIGURATIONS

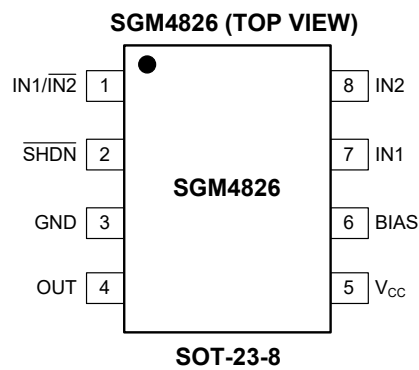
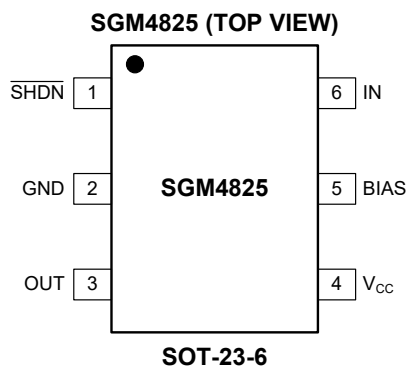
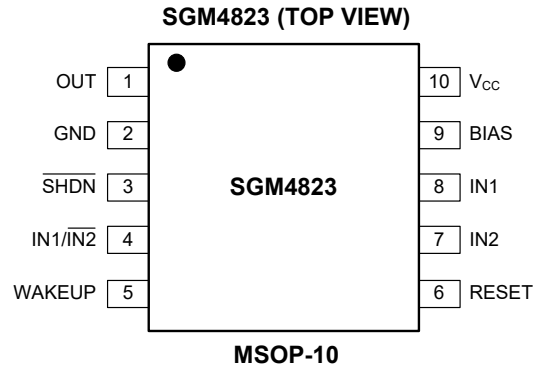
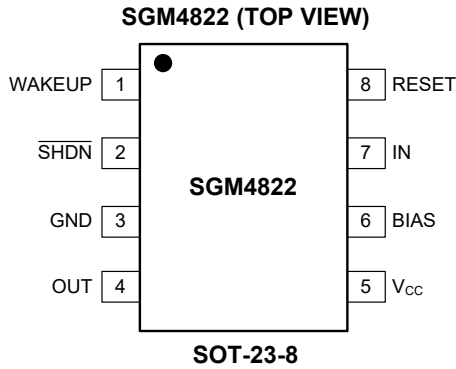

PIN DESCRIPTION

PIN				NAME	FUNCTION
SGM4822	SGM4823	SGM4825	SGM4826		
1	5	–	–	WAKEUP	Output to Wake up External Equipment in Sleeping Mode.
2	3	1	2	SHDN	Active Low Shutdown Input. Logic high enables the device. Logic low disables the device and turns it into shutdown mode. Do not leave this pin floating.
3	2	2	3	GND	Ground.
4	1	3	4	OUT	Amplifier Output.
5	10	4	5	V _{CC}	Positive Supply. Connect a 0.1µF capacitor between V _{CC} pin and GND pin.
6	9	5	6	BIAS	Low Noise Microphone Bias Output.
7	–	6	–	IN	Amplifier Input.
8	6	–	–	RESET	WAKEUP Reset Pin and Set SGM4822/SGM4823 to Monitor Mode.
–	8	–	7	IN1	Amplifier Input 1.
–	7	–	8	IN2	Amplifier Input 2.
–	4	–	1	IN1/IN2	Input Selection Pin. When this pin is pulled high, IN1 is selected. While this pin is pulled low, IN2 is selected.

ELECTRICAL CHARACTERISTICS

($V_{CC} = 3.3V$ to $5V$, $V_{GND} = 0V$, $R_L = \text{open}$, $\overline{\text{SHDN}} = V_{CC}$, Full = -40°C to $+85^{\circ}\text{C}$, typical values are at $T_A = +25^{\circ}\text{C}$, unless otherwise noted.)

PARAMETER	SYMBOL	CONDITIONS	MIN	TYP	MAX	UNITS
General						
Supply Voltage Range	V_{CC}	SGM4822/SGM4823	3.3		5.5	V
		SGM4825/SGM4826	2.7		5.5	
Supply Current	I_{CC}	In shutdown, $\overline{\text{SHDN}} = \text{GND}$ (SGM4822/3)		0.1	2	μA
		In shutdown, $\overline{\text{SHDN}} = \text{GND}$ (SGM4825/6)		1.5	4	
		In monitor mode, RESET = 1.6V, $V_{CC} = 3.3V$		4	8	
		In monitor mode, RESET = 1.6V, $V_{CC} = 5V$		15	20	
		In active mode		660	1050	
Amplifier Output Bias Voltage	V_{OUT_DC}	$V_{CC} = 3.3V$	1.39	1.55	1.71	V
		$V_{CC} = 5V$	2.26	2.55	2.74	
Input Resistance	R_{IN}			115		k Ω
Voltage Gain	A_V		19.6	20	20.4	dB
Power Supply Rejection Ratio	PSRR _{OUT}	Input referred		55		dB
Output Voltage Swing	V_{OH}	$R_L = 10k\Omega$ to $V_{CC}/2$		$V_{CC} - 0.0045$		V
		$R_L = 1k\Omega$ to $V_{CC}/2$	$V_{CC} - 0.055$	$V_{CC} - 0.038$		
	V_{OL}	$R_L = 10k\Omega$ to $V_{CC}/2$		0.0035		
		$R_L = 1k\Omega$ to $V_{CC}/2$		0.03	0.05	
Output Short-Circuit Current	I_{OUT_SC}	$V_{CC} = 3.3V$, sinking or sourcing	28	45		mA
		$V_{CC} = 5V$, sinking or sourcing	70	100		
Small-Signal -3dB Bandwidth	BW	$V_{OUT} = 10mV_{P-P}$		2.6		MHz
Output Capacitive Load Stability	C_L	No sustained oscillations		50		pF
Output Impedance	Z_{OUT}	$f = 1kHz$		0.02		Ω
Output Slew Rate	SR	$V_{OUT} = 1V$ step		4.8		V/ μs
Amplifier Input Voltage Noise Density	e_n	Inputs at AC GND, $f = 1kHz$, Gain = 20dB		30		nV/ $\sqrt{\text{Hz}}$
Total Integrated Input Noise	V_n	Inputs at AC GND, A-weighted, BW = 22Hz to 22kHz,		2.3		μV_{RMS}
Off-Isolation		Input referred, SGM4823/SGM4826	1kHz	97		dB
			10kHz	96		
Total Harmonic Distortion + Noise	THD+N	$f = 1kHz$, Gain = 20dB, $V_{OUT} = 1V_{P-P}$, BW = 22Hz to 22kHz		0.009		%
Bias						
Bias Output Voltage Range	V_{BIAS}		2.21	2.3	2.42	V
Power Supply Rejection Ratio (V_{CC} to BIAS)	PSRR _{BIAS}			55		dB
BIAS Current Limit	I_{BIAS_SC}	BIAS short to GND, $V_{CC} = 3.3V$	18	40		mA
		BIAS short to GND, $V_{CC} = 5V$	40	80		
BIAS Capacitive Load Stability	C_{BIAS}	No sustained oscillations		50		pF
Total Integrated BIAS Noise	V_n	A-weighted, BW = 22Hz to 22kHz		30		μV_{RMS}
Threshold of Comparator at Audio Monitor Circuit (Internal Bias Voltage + V_{tha})						
Threshold of Audio Signal	V_{THA}	SGM4822/SGM4823		0.2		V

ELECTRICAL CHARACTERISTICS (continued)

($V_{CC} = 3.3V$ to $5V$, $V_{GND} = 0V$, $R_L = \text{open}$, $\overline{\text{SHDN}} = V_{CC}$, Full = -40°C to $+85^\circ\text{C}$, typical values are at $T_A = +25^\circ\text{C}$, unless otherwise noted.)

PARAMETER	SYMBOL	CONDITIONS	MIN	TYP	MAX	UNITS
Digital Inputs (RESET, $\overline{\text{SHDN}}$, IN1/IN2, WAKEUP)						
Logic Low Threshold	V_{IL}				0.4	V
Logic High Threshold	V_{IH}		2			V
Logic Input Current	I_{IN}	$\overline{\text{SHDN}} = \text{GND or } V_{CC}$			± 1	μA
Shutdown Enable Time	$t_{\text{SHDN_ON}}$	95% of settled value		25		μs
Shutdown Disable Time	$t_{\text{SHDN_OFF}}$			100		ns
IN1/IN2 Select Time	t_{SEL}			40		μs

TYPICAL PERFORMANCE CHARACTERISTICS

$T_A = +25^\circ\text{C}$, $V_{CC} = 5V$, $V_{GND} = 0V$, $R_L = \text{open}$, $\overline{\text{SHDN}} = V_{CC}$, unless otherwise noted.

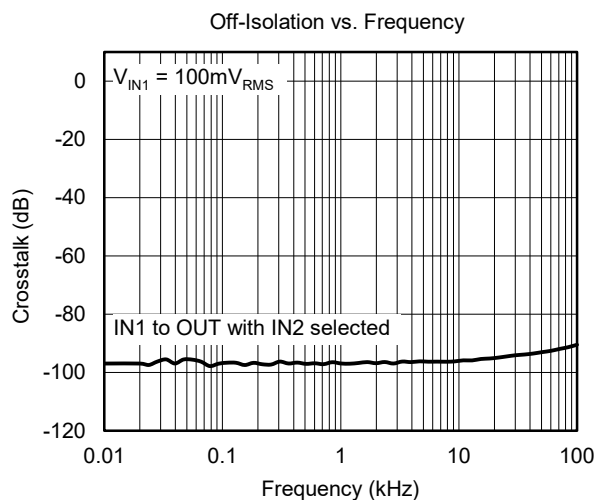
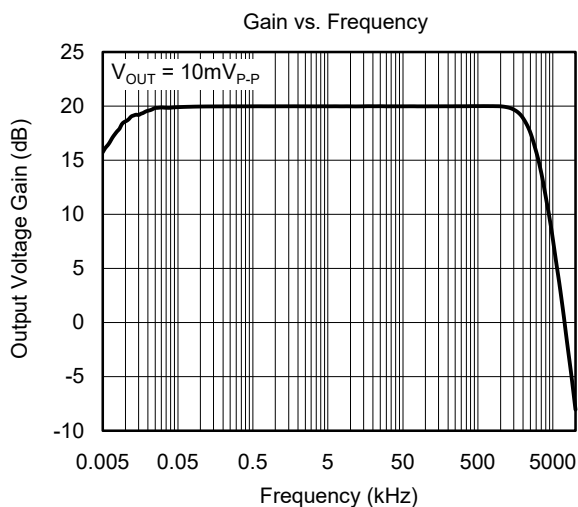
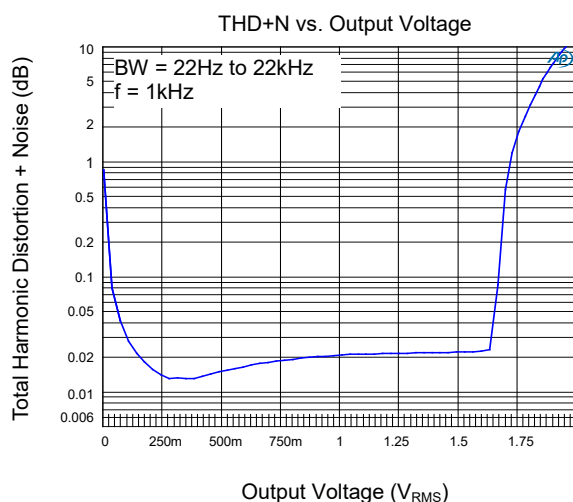
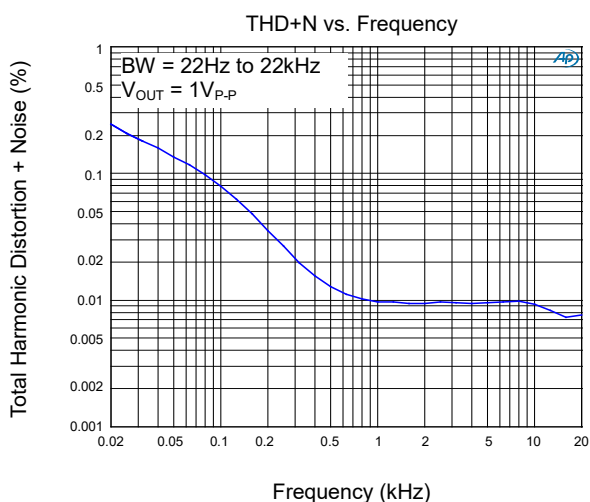

TYPICAL PERFORMANCE CHARACTERISTICS (continued)

$T_A = +25^\circ\text{C}$, $V_{CC} = 5\text{V}$, $V_{GND} = 0\text{V}$, $R_L = \text{open}$, $\overline{\text{SHDN}} = V_{CC}$, unless otherwise noted.

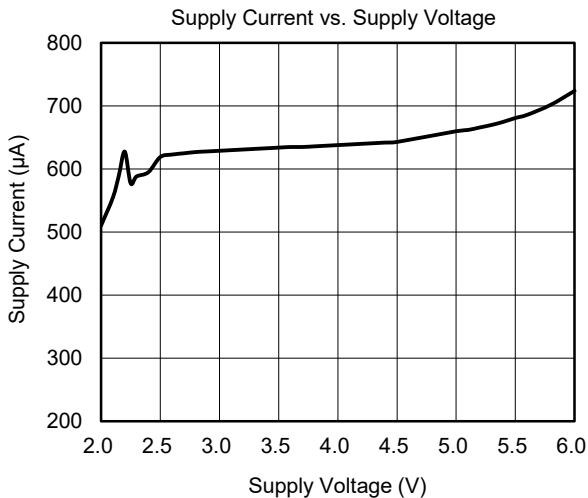
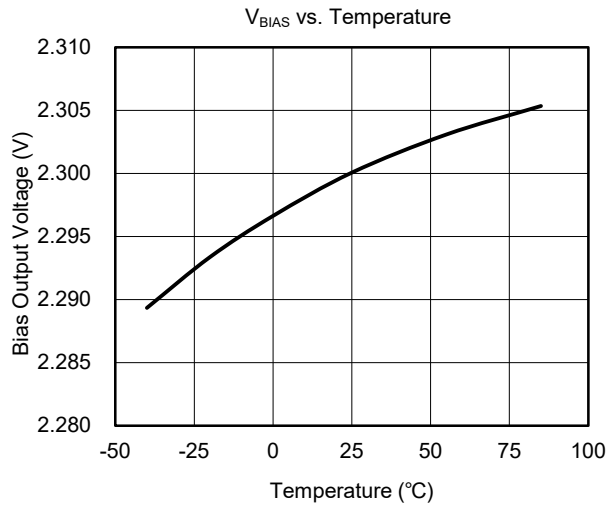
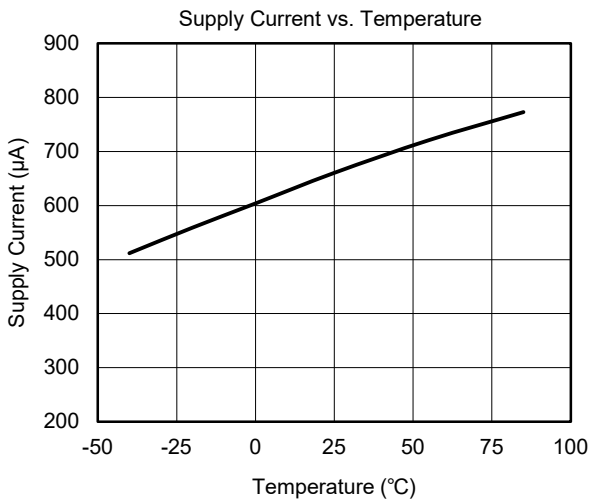
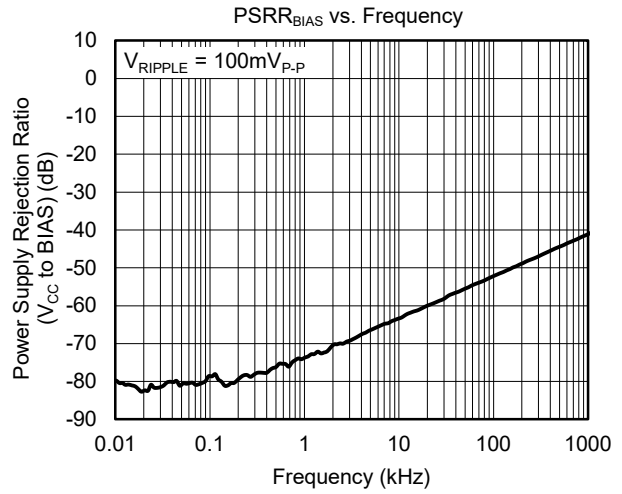
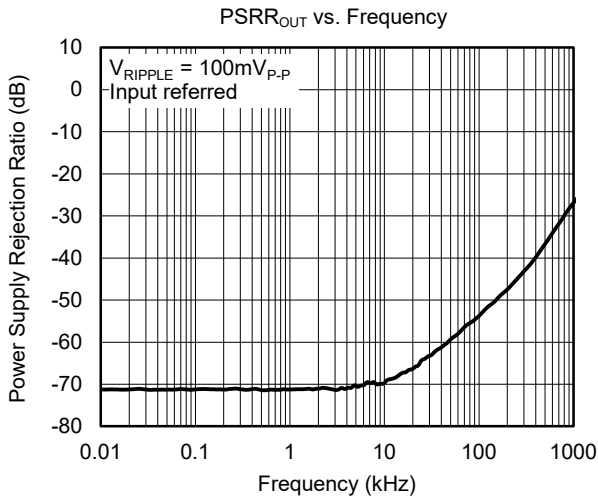

TYPICAL PERFORMANCE CHARACTERISTICS (continued)

$T_A = +25^\circ\text{C}$, $V_{CC} = 5\text{V}$, $V_{GND} = 0\text{V}$, $R_L = \text{open}$, $\overline{\text{SHDN}} = V_{CC}$, unless otherwise noted.

Small Signal Pulse Response

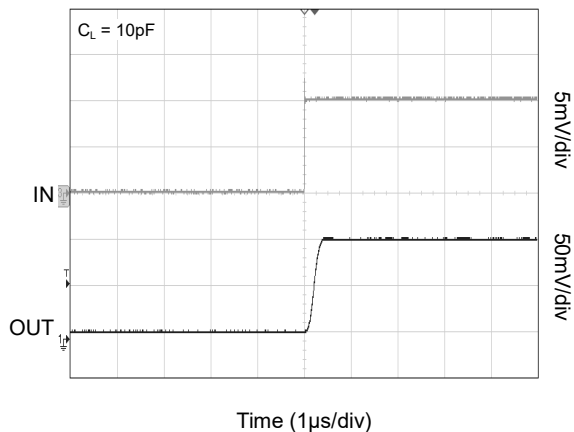

Large Signal Pulse Response

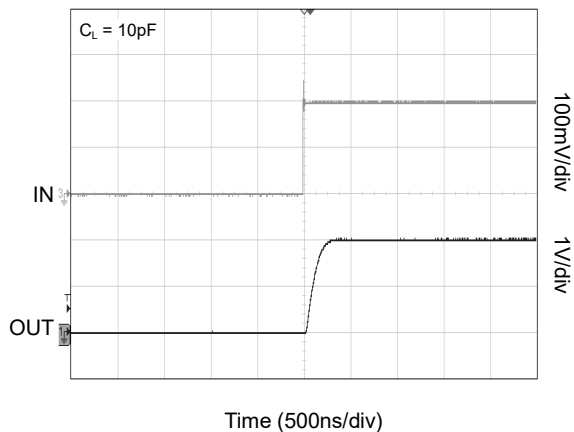

Out of Shutdown Waveform Input Unconnected

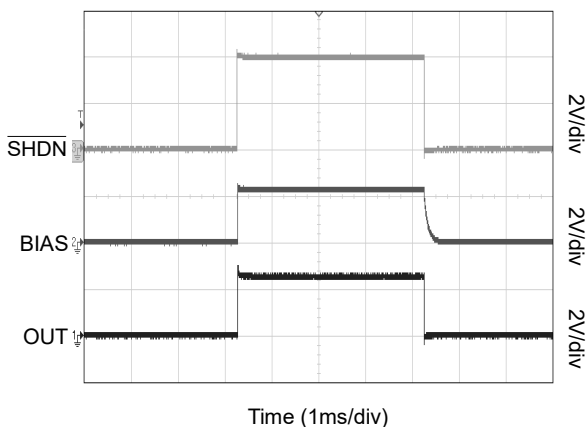

Switch between Two Inputs

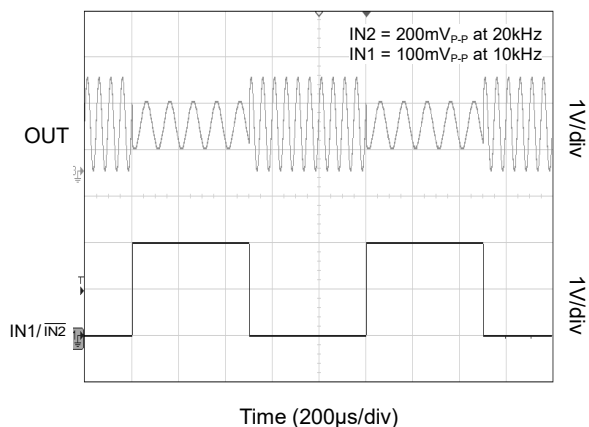

Output Overdriven

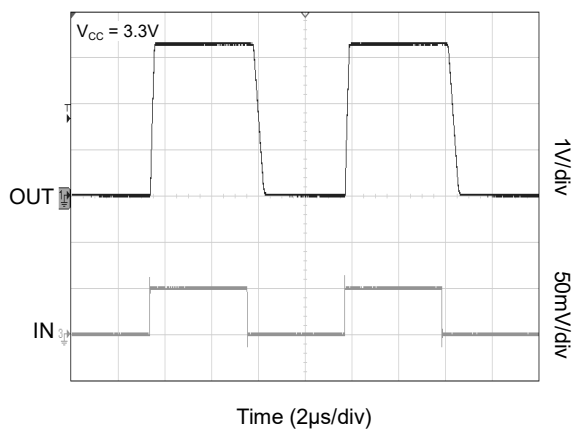

FUNCTIONAL BLOCK DIAGRAM

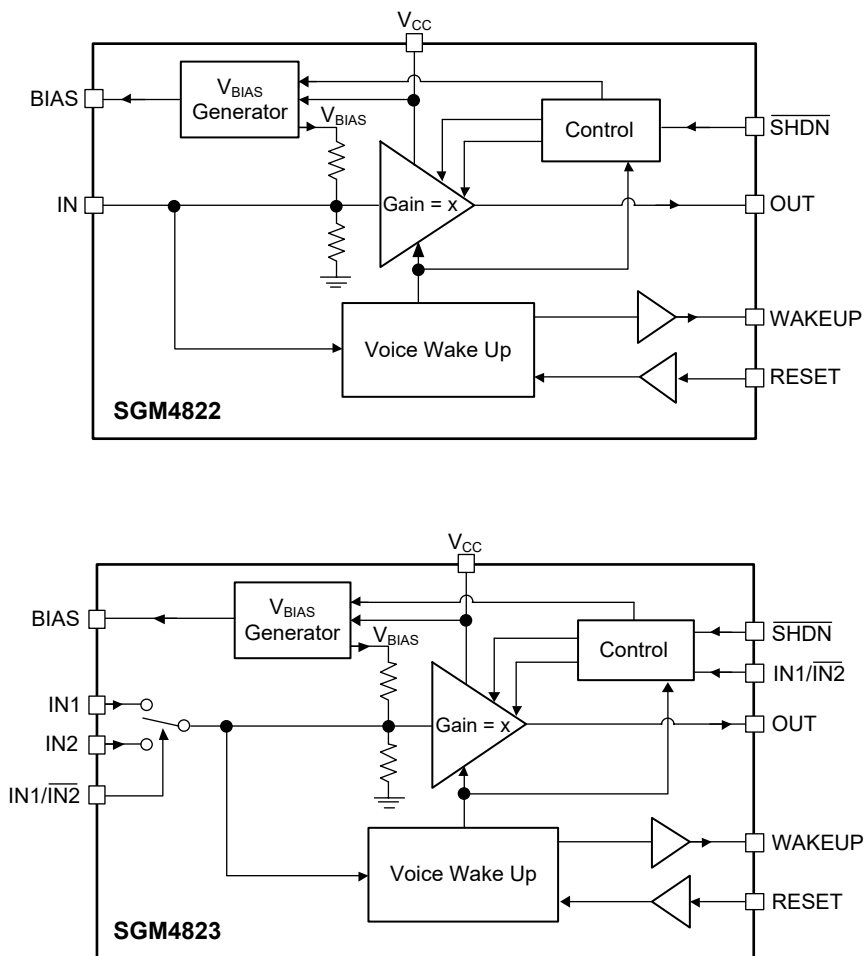

FUNCTIONAL BLOCK DIAGRAM (continued)

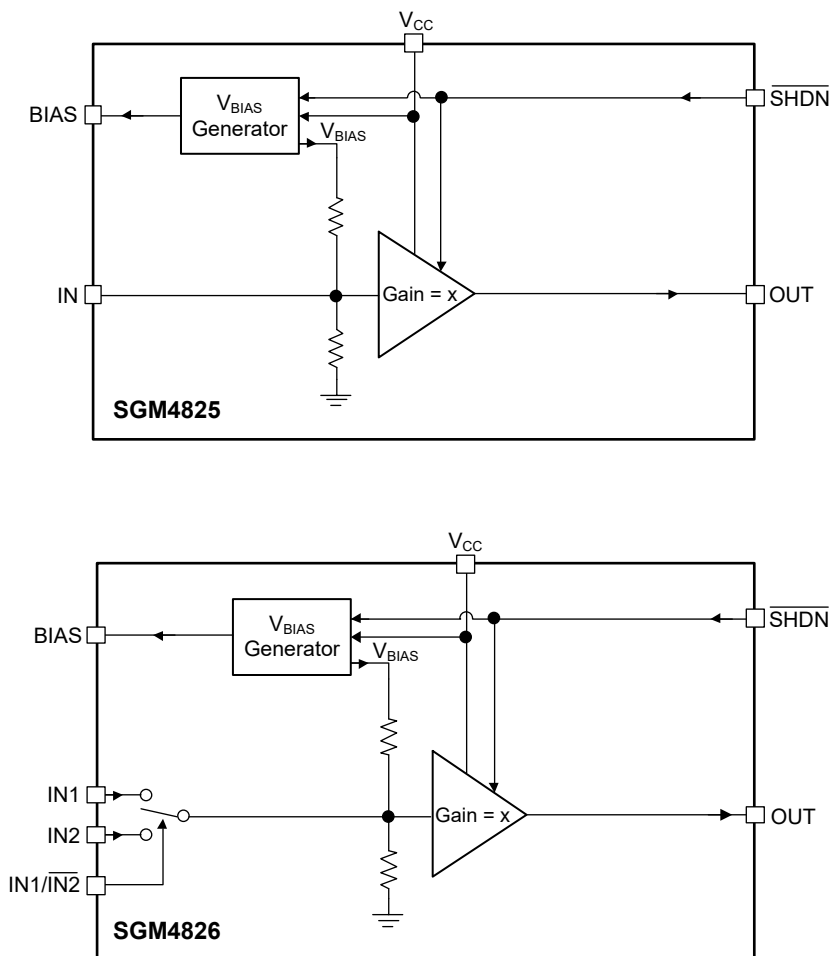

Figure 1. Block Diagram

REVISION HISTORY

NOTE: Page numbers for previous revisions may differ from page numbers in the current version.

Changes from Original (SEPTEMBER 2018) to REV.A

Changed from product preview to production data.....	All
--	-----

PACKAGE OUTLINE DIMENSIONS

SOT-23-8

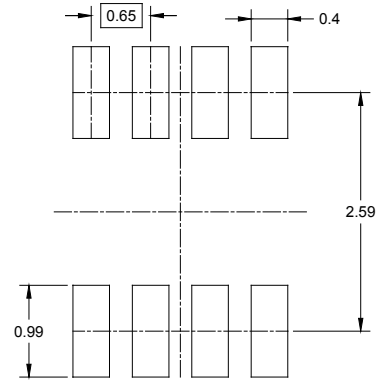
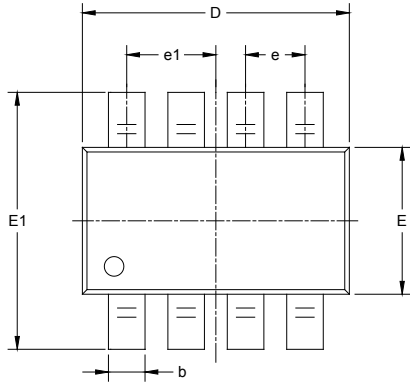

RECOMMENDED LAND PATTERN (Unit: mm)

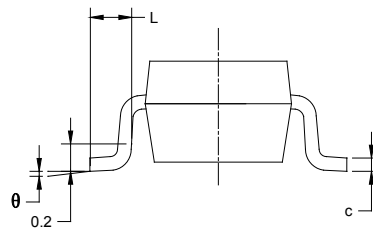
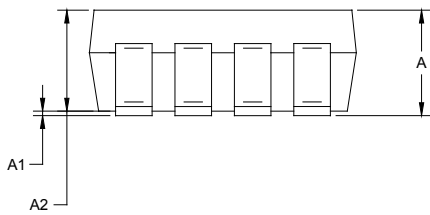

Symbol	Dimensions In Millimeters		Dimensions In Inches	
	MIN	MAX	MIN	MAX
A	1.050	1.250	0.041	0.049
A1	0.000	0.100	0.000	0.004
A2	1.050	1.150	0.041	0.045
b	0.300	0.500	0.012	0.020
c	0.100	0.200	0.004	0.008
D	2.820	3.020	0.111	0.119
E	1.500	1.700	0.059	0.067
E1	2.650	2.950	0.104	0.116
e	0.650 BSC		0.026 BSC	
e1	0.975 BSC		0.038 BSC	
L	0.300	0.600	0.012	0.024
θ	0°	8°	0°	8°

PACKAGE OUTLINE DIMENSIONS

MSOP-10

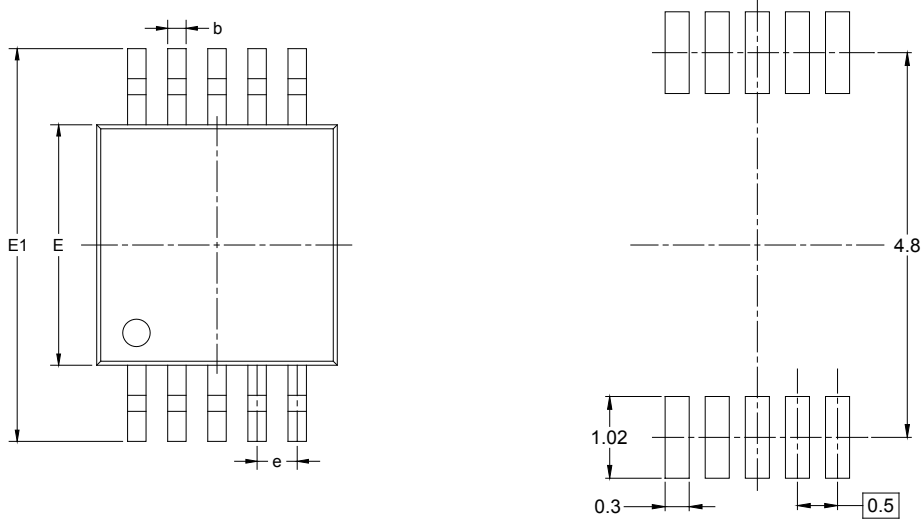

RECOMMENDED LAND PATTERN (Unit: mm)

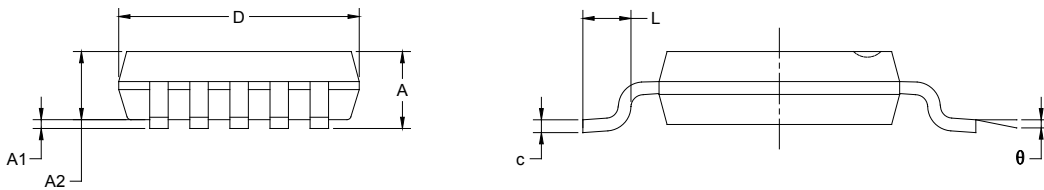

Symbol	Dimensions In Millimeters		Dimensions In Inches	
	MIN	MAX	MIN	MAX
A	0.820	1.100	0.032	0.043
A1	0.020	0.150	0.001	0.006
A2	0.750	0.950	0.030	0.037
b	0.180	0.280	0.007	0.011
c	0.090	0.230	0.004	0.009
D	2.900	3.100	0.114	0.122
E	2.900	3.100	0.114	0.122
E1	4.750	5.050	0.187	0.199
e	0.500 BSC		0.020 BSC	
L	0.400	0.800	0.016	0.031
θ	0°	6°	0°	6°

PACKAGE OUTLINE DIMENSIONS

SOT-23-6

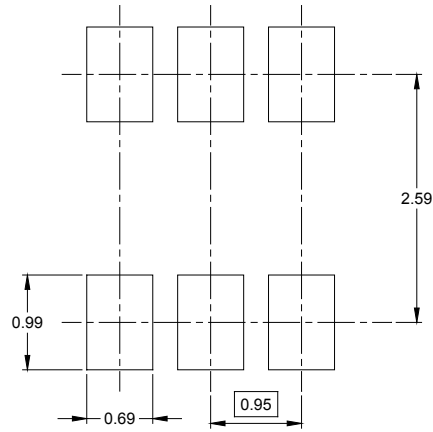
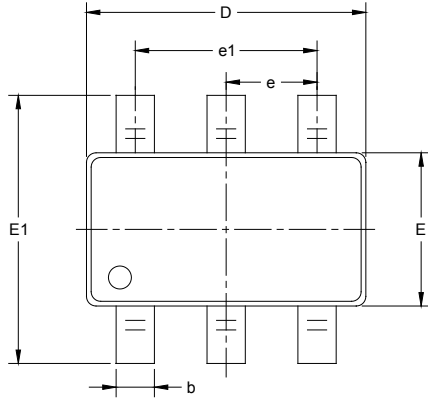

RECOMMENDED LAND PATTERN (Unit: mm)

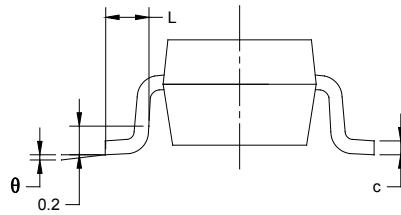
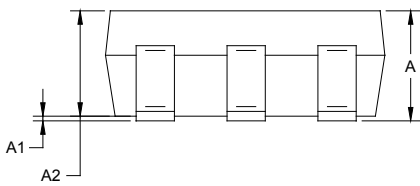

Symbol	Dimensions In Millimeters		Dimensions In Inches	
	MIN	MAX	MIN	MAX
A	1.050	1.250	0.041	0.049
A1	0.000	0.100	0.000	0.004
A2	1.050	1.150	0.041	0.045
b	0.300	0.500	0.012	0.020
c	0.100	0.200	0.004	0.008
D	2.820	3.020	0.111	0.119
E	1.500	1.700	0.059	0.067
E1	2.650	2.950	0.104	0.116
e	0.950 BSC		0.037 BSC	
e1	1.900 BSC		0.075 BSC	
L	0.300	0.600	0.012	0.024
θ	0°	8°	0°	8°

PACKAGE INFORMATION

TAPE AND REEL INFORMATION

REEL DIMENSIONS



TAPE DIMENSIONS



NOTE: The picture is only for reference. Please make the object as the standard.

KEY PARAMETER LIST OF TAPE AND REEL

Package Type	Reel Diameter	Reel Width W1 (mm)	A0 (mm)	B0 (mm)	K0 (mm)	P0 (mm)	P1 (mm)	P2 (mm)	W (mm)	Pin1 Quadrant
SOT-23-8	7"	9.5	3.17	3.23	1.37	4.0	4.0	2.0	8.0	Q3
MSOP-10	13"	12.4	5.20	3.30	1.20	4.0	8.0	2.0	12.0	Q1
SOT-23-6	7"	9.5	3.17	3.23	1.37	4.0	4.0	2.0	8.0	Q3

DD0001

PACKAGE INFORMATION

CARTON BOX DIMENSIONS



NOTE: The picture is only for reference. Please make the object as the standard.

KEY PARAMETER LIST OF CARTON BOX

Reel Type	Length (mm)	Width (mm)	Height (mm)	Pizza/Carton
7" (Option)	368	227	224	8
7"	442	410	224	18
13"	386	280	370	5

DD0002