

### GENERAL DESCRIPTION

The SGM66057A is an internally compensated, 2.4MHz switching frequency, current mode, synchronous Boost switching converter. The output voltage is fixed at 5.0V. The SGM66057A implements a MODE pin to configure forced PWM mode or auto PFM mode at light loads. Its output is disconnected by the rectifier circuit during shutdown, with no input to output leakage.

Various protection features such as over-current, short-circuit and over-temperature are implemented to protect the device from various fault conditions.

The SGM66057A is available in a Green WLCSP-1.26×1.21-9B package.

### FEATURES

- 2.7V to 4.85V Operating Input Voltage Range
- 5.0V Fixed Output Voltage
- Up to 96.8% Efficiency
- 3.45A (TYP) Valley Switch Current Limit
- 2.4MHz (TYP) Switching Frequency
- Selectable Forced PWM or Auto PFM Mode at Light Loads
- Input and Output Disconnect when EN Low
- Output Short-Circuit and Over-Voltage Protections
- Thermal Shutdown Protection
- Available in a Green WLCSP-1.26×1.21-9B Package

### APPLICATIONS

- USB OTG
- Boost from Single cell Li-Ion Battery
- Smart Phones and Tablets
- Portable and Wearable Devices

### TYPICAL APPLICATION

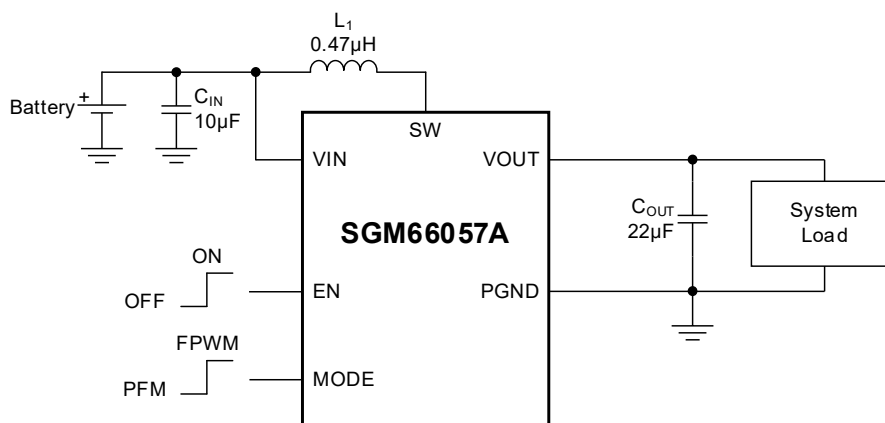

Figure 1. Typical Application Circuit

**PACKAGE/ORDERING INFORMATION**

MODEL	PACKAGE DESCRIPTION	SPECIFIED TEMPERATURE RANGE	ORDERING NUMBER	PACKAGE MARKING	PACKING OPTION
SGM66057A-5.0	WLCSP-1.26x1.21-9B	-40°C to +85°C	SGM66057A-5.0YG/TR	XXXX 0P9	Tape and Reel, 3000

**MARKING INFORMATION**

NOTE: XXXX = Date Code, Trace Code and Vendor Code.

**XXXX**

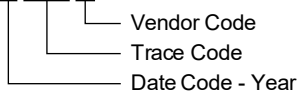

Green (RoHS & HSF): SG Micro Corp defines "Green" to mean Pb-Free (RoHS compatible) and free of halogen substances. If you have additional comments or questions, please contact your SGMICRO representative directly.

**ABSOLUTE MAXIMUM RATINGS**

VIN Voltage.....	-0.3V to 5.5V
VOUT and EN Voltages.....	-0.3V to 6V
SW Node (DC).....	-0.3V to 6V
SW Node (Transient: 10ns, 3MHz).....	-1V to 8V
Voltage on Other Pins.....	-0.3V to 6V <sup>(1)</sup>
Package Thermal Resistance	
WLCSP-1.26x1.21-9B, $\theta_{JA}$ .....	90°C/W
Junction Temperature.....	+150°C
Storage Temperature Range.....	-65°C to +150°C
Lead Temperature (Soldering, 10s).....	+260°C
ESD Susceptibility	
HBM.....	4000V
CDM.....	1000V

NOTE: 1. Lesser of 6V or  $V_{IN} + 0.3V$ .

**RECOMMENDED OPERATING CONDITIONS**

Input Voltage Range.....	2.7V to 4.85V
Operating Junction Temperature Range.....	-40°C to +125°C

**OVERSTRESS CAUTION**

Stresses beyond those listed in Absolute Maximum Ratings may cause permanent damage to the device. Exposure to absolute maximum rating conditions for extended periods may affect reliability. Functional operation of the device at any conditions beyond those indicated in the Recommended Operating Conditions section is not implied.

**ESD SENSITIVITY CAUTION**

This integrated circuit can be damaged if ESD protections are not considered carefully. SGMICRO recommends that all integrated circuits be handled with appropriate precautions. Failure to observe proper handling and installation procedures can cause damage. ESD damage can range from subtle performance degradation to complete device failure. Precision integrated circuits may be more susceptible to damage because even small parametric changes could cause the device not to meet the published specifications.

**DISCLAIMER**

SG Micro Corp reserves the right to make any change in circuit design, or specifications without prior notice.

**PIN CONFIGURATION**

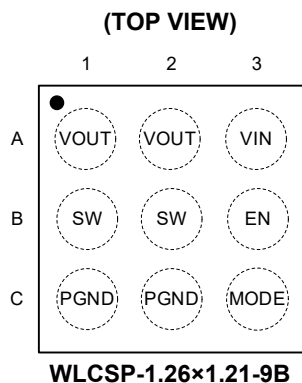

**PIN DESCRIPTION**

PIN	NAME	FUNCTION
A1, A2	VOUT	Boost Converter Output.
A3	VIN	Power Supply Input.
B1, B2	SW	Switching Node. Drain connection of low-side power MOSFET.
B3	EN	Device Enable Node. Pulling this pin logic high enables the device and pulling it logic low disables the device.
C1, C2	PGND	Power Ground.
C3	MODE	Mode Selection Pin. Logic high for forced PWM operation, and logic low for auto PFM operation at light loads.

**ELECTRICAL CHARACTERISTICS**(V<sub>IN</sub> = 3.6V, T<sub>J</sub> = -40°C to +85°C, typical values are at T<sub>J</sub> = +25°C, unless otherwise noted.)

PARAMETER	SYMBOL	CONDITIONS	MIN	TYP	MAX	UNITS
<b>DC/DC Stage</b>						
Input Voltage	V <sub>IN</sub>	T <sub>J</sub> = +25°C	2.7		4.85	V
UVLO Rising Threshold	V <sub>UVLO_R</sub>	T <sub>J</sub> = +25°C	2.03	2.34	2.66	V
UVLO Falling Threshold	V <sub>UVLO_F</sub>	T <sub>J</sub> = +25°C	1.97	2.27	2.5	V
UVLO Hysteresis Voltage	V <sub>UVLO_HYS</sub>			70		mV
Switching Frequency	f <sub>SW</sub>		1.96	2.40	2.79	MHz
Switch Current Limit	I <sub>L</sub>	T <sub>J</sub> = +25°C	3	3.45	4.1	A
Boost Switch On-Resistance	R <sub>DSON</sub>	V <sub>OUT</sub> = 5.0V, T <sub>J</sub> = +25°C		55	85	mΩ
Rectifying Switch On-Resistance	R <sub>DSON</sub>	V <sub>OUT</sub> = 5.0V, T <sub>J</sub> = +25°C		75	100	mΩ
Output Voltage	V <sub>OUT</sub>		4.93	5.00	5.17	V
Quiescent Current	I <sub>Q</sub>	V <sub>EN</sub> = V <sub>IN</sub> = 3.6V, V <sub>MODE</sub> = 0V, no switching, T <sub>J</sub> = +25°C		24	37	μA
Shutdown Current	I <sub>SD</sub>	V <sub>EN</sub> = 0V, V <sub>IN</sub> = 3.6V, T <sub>J</sub> = +25°C		0.01	1	μA
<b>Control Stage</b>						
EN Input Low Voltage	V <sub>IL</sub>				0.4	V
EN Input High Voltage	V <sub>IH</sub>		1.3			V
EN Input Current	I <sub>EN</sub>	Clamped to GND or VIN		0.01		μA
MODE Input Low Voltage	V <sub>IL</sub>				0.4	V
MODE Input High Voltage	V <sub>IH</sub>		1.3			V
MODE Input Current	I <sub>MODE</sub>	Clamped to GND or VIN		0.01		μA
Over-Temperature Protection	T <sub>SD</sub>			150		°C
Over-Temperature Hysteresis	T <sub>SD_HYS</sub>			20		°C

**TYPICAL PERFORMANCE CHARACTERISTICS**

At  $T_J = +25^\circ\text{C}$ ,  $V_{IN} = 3.6\text{V}$ ,  $C_{IN} = 10\mu\text{F}$ ,  $C_{OUT} = 20\mu\text{F}$  and  $L_1 = 0.47\mu\text{H}$ , unless otherwise noted.

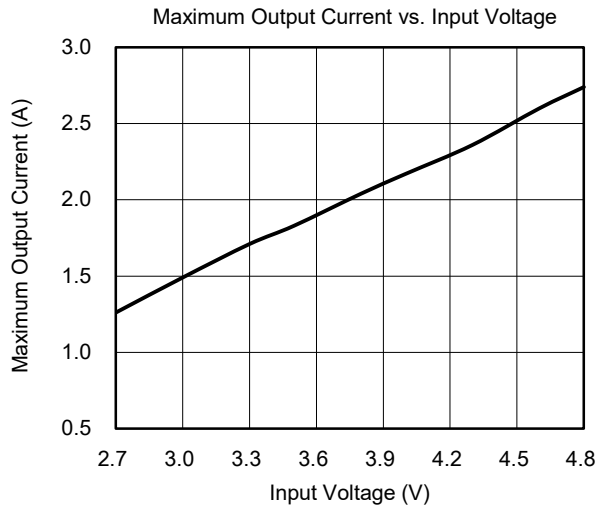
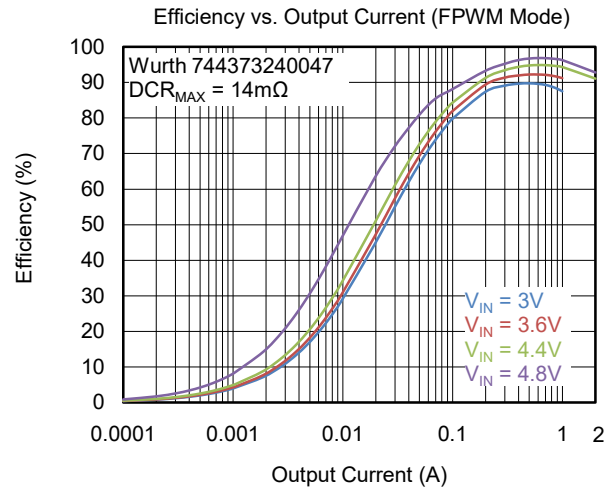
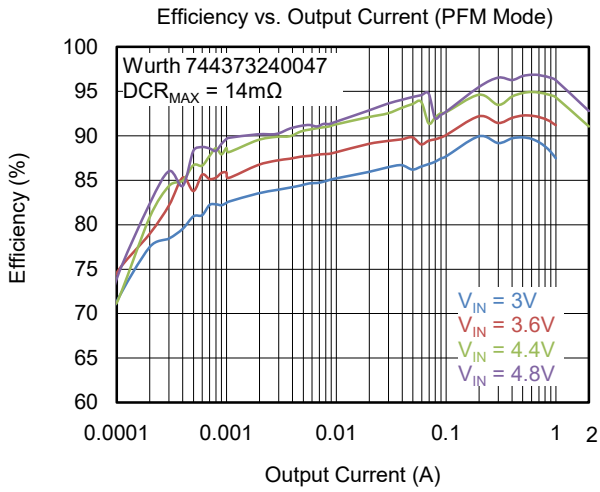

TYPICAL PERFORMANCE CHARACTERISTICS (continued)

At  $T_J = +25^\circ\text{C}$ ,  $V_{IN} = 3.6\text{V}$ ,  $C_{IN} = 10\mu\text{F}$ ,  $C_{OUT} = 20\mu\text{F}$  and  $L_1 = 0.47\mu\text{H}$ , unless otherwise noted.

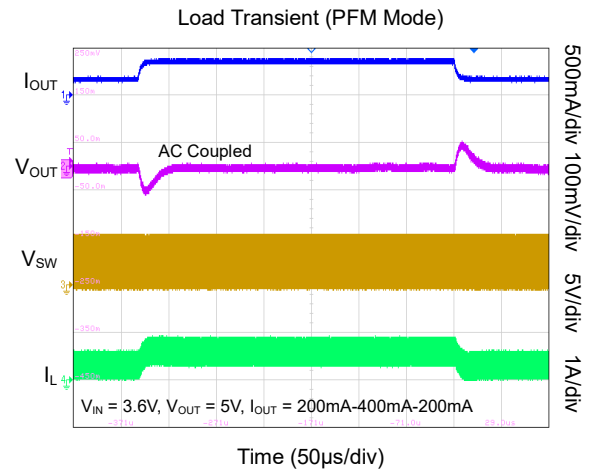
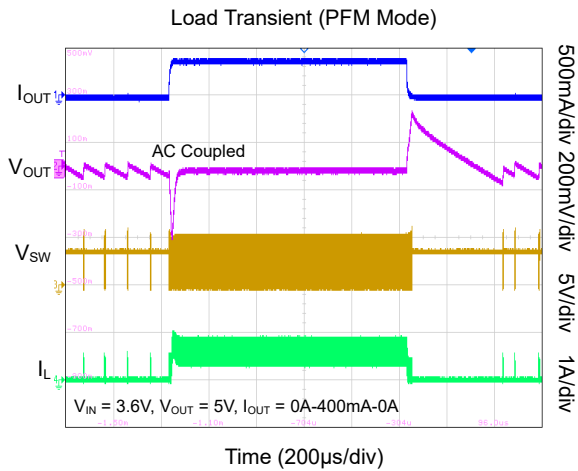
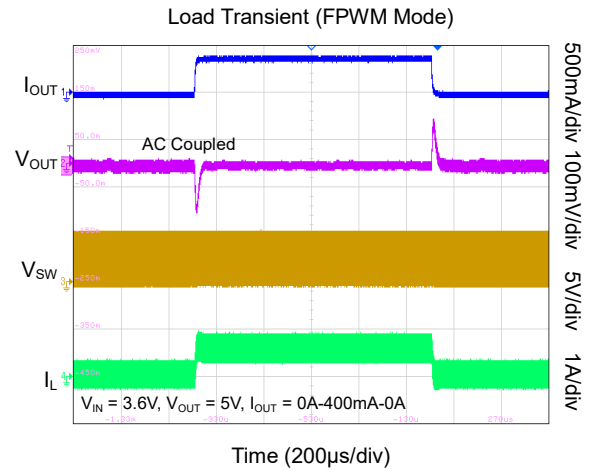
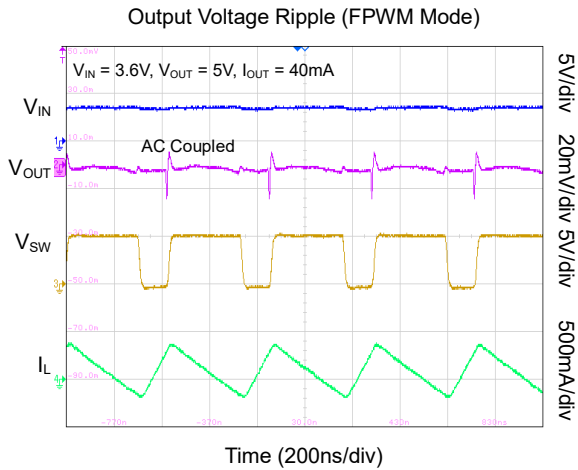
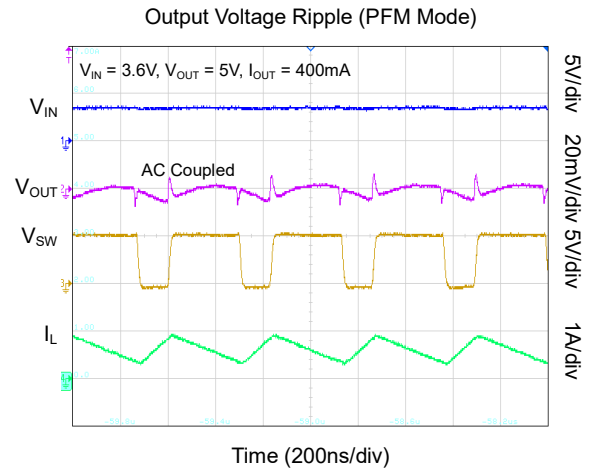
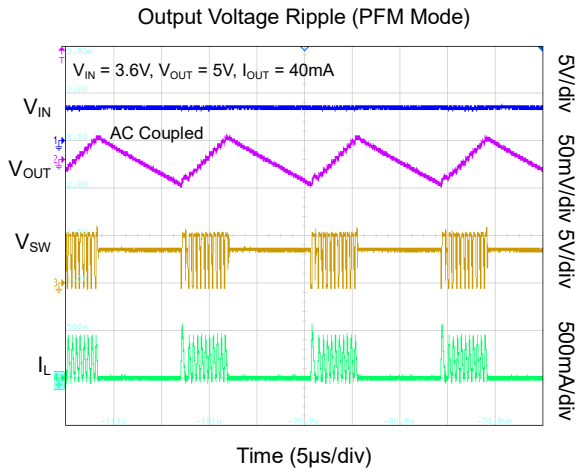

TYPICAL PERFORMANCE CHARACTERISTICS (continued)

At  $T_J = +25^\circ\text{C}$ ,  $V_{IN} = 3.6\text{V}$ ,  $C_{IN} = 10\mu\text{F}$ ,  $C_{OUT} = 20\mu\text{F}$  and  $L_1 = 0.47\mu\text{H}$ , unless otherwise noted.

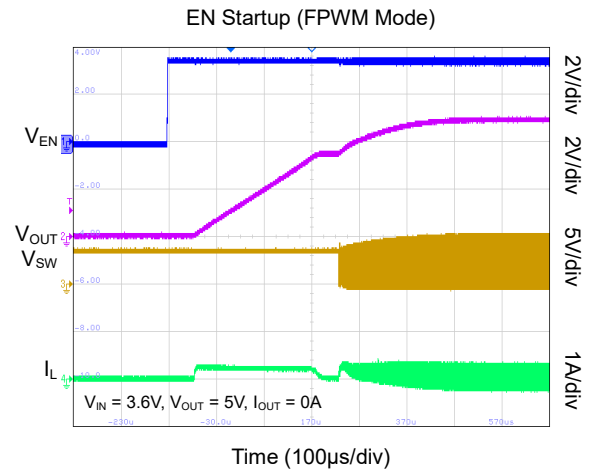
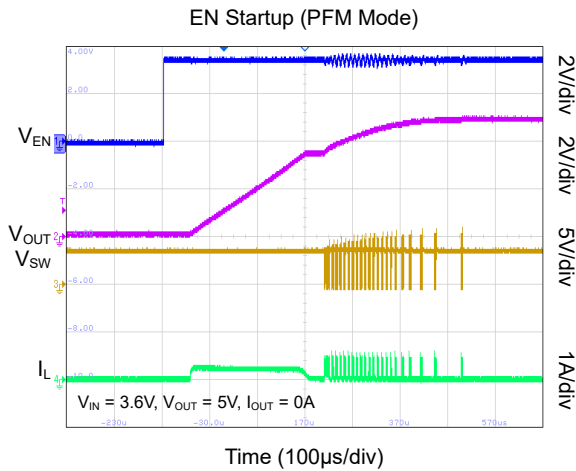
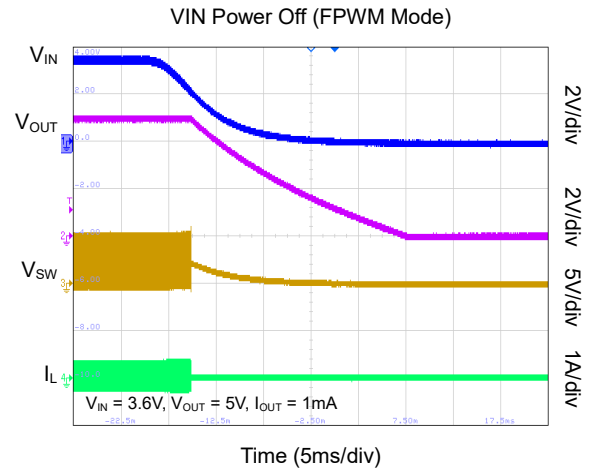
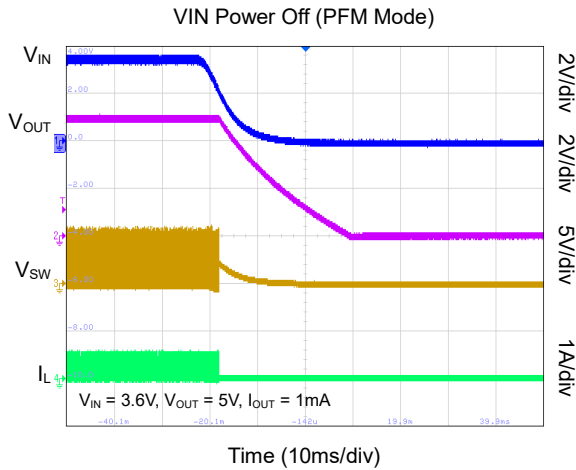
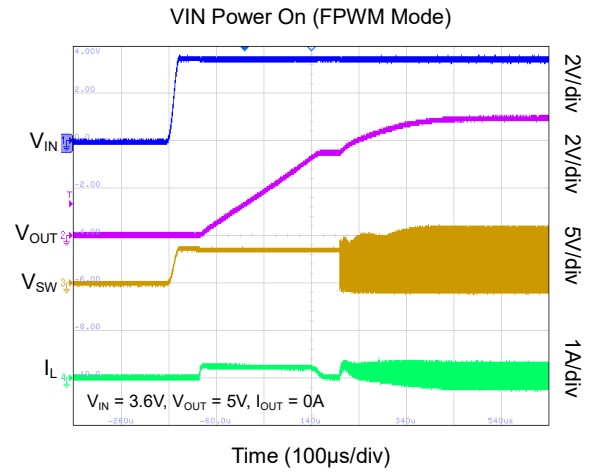
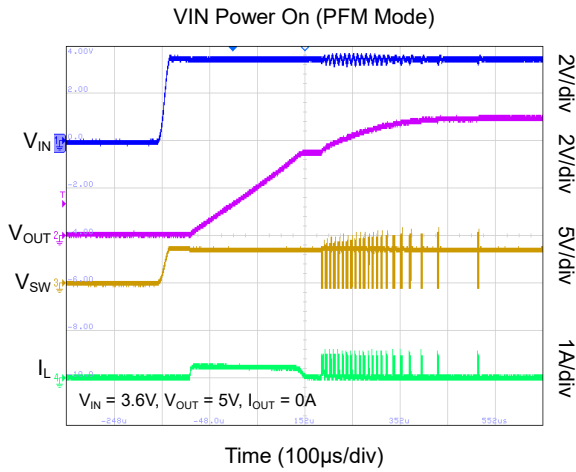

TYPICAL PERFORMANCE CHARACTERISTICS (continued)

At  $T_J = +25^\circ\text{C}$ ,  $V_{IN} = 3.6\text{V}$ ,  $C_{IN} = 10\mu\text{F}$ ,  $C_{OUT} = 20\mu\text{F}$  and  $L_1 = 0.47\mu\text{H}$ , unless otherwise noted.

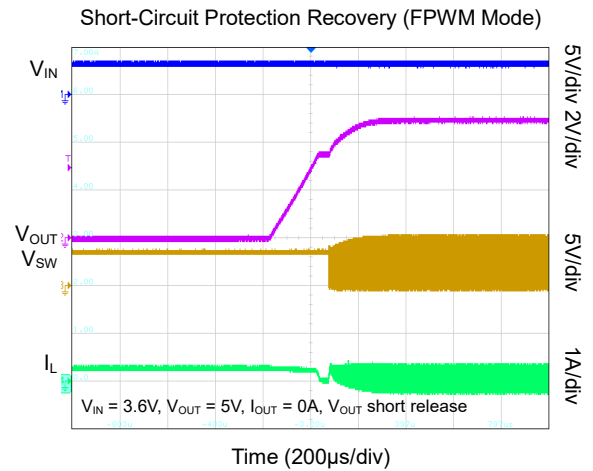
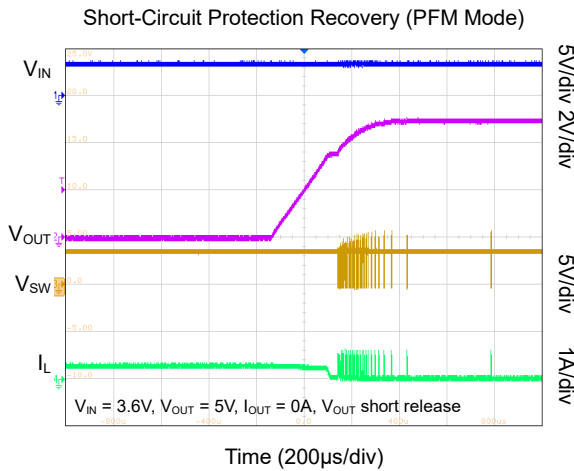
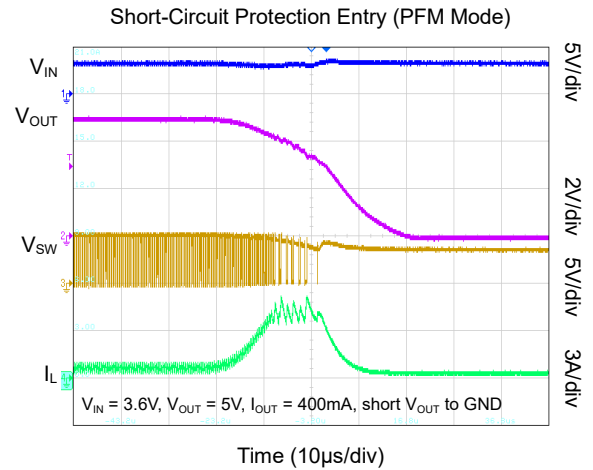
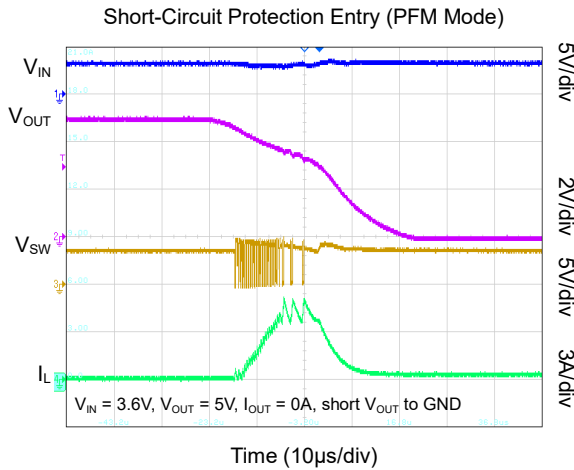
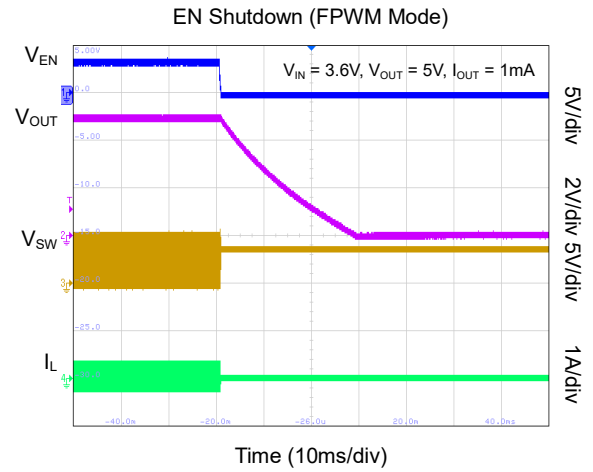
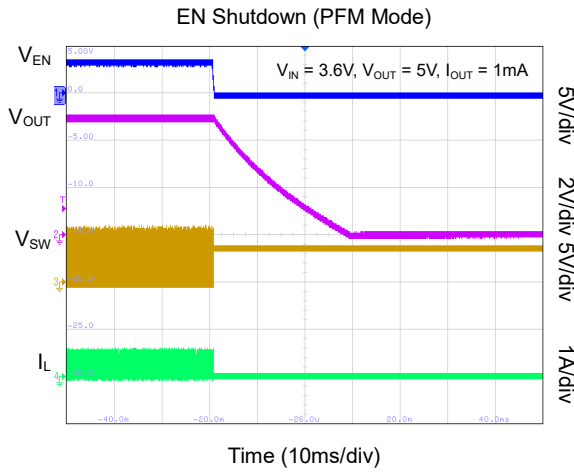



**FUNCTIONAL BLOCK DIAGRAM**

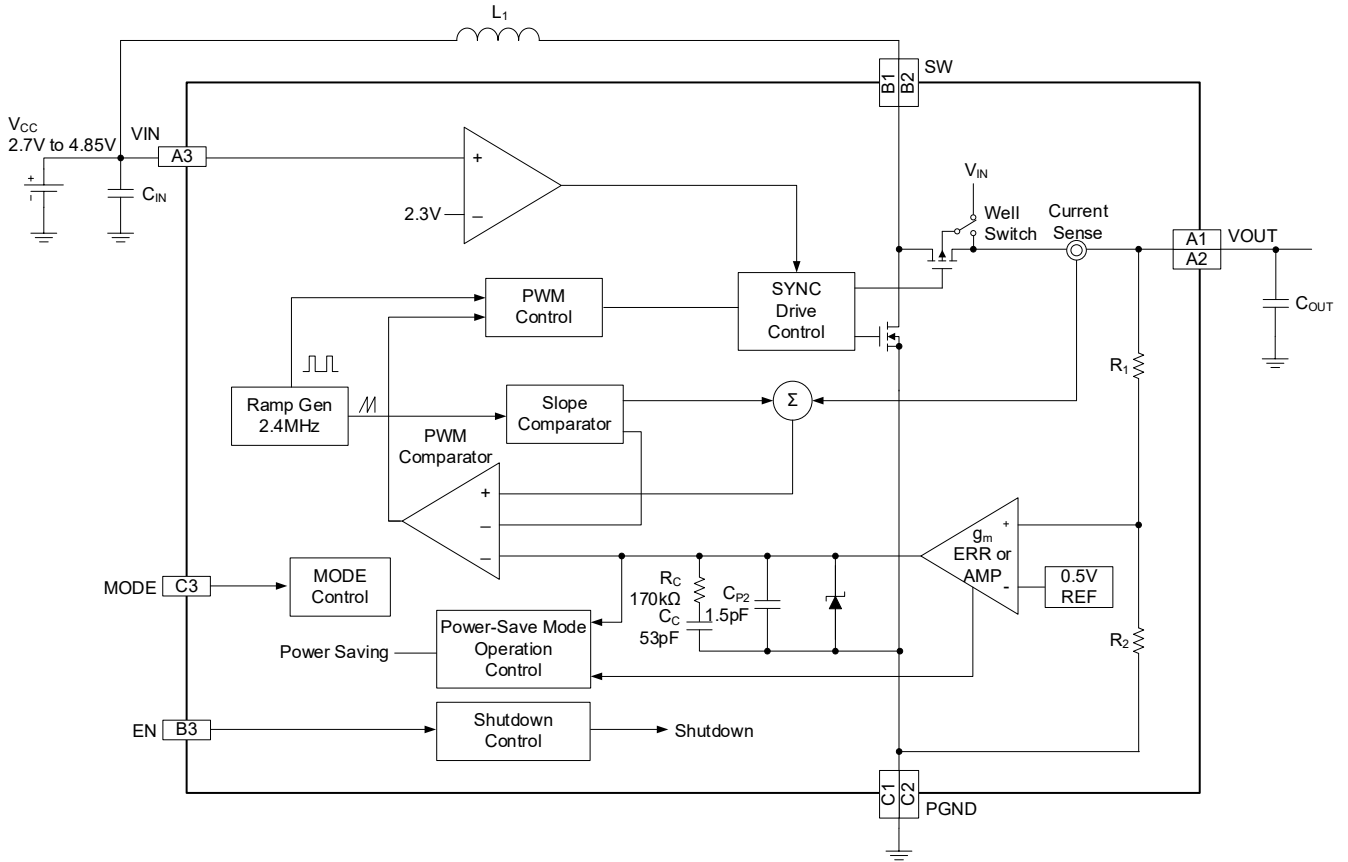

**Figure 2. SGM66057A Block Diagram**

## APPLICATION INFORMATION

The SGM66057A is a fully-integrated synchronous Boost DC/DC converter. The recommended input supply voltage for full performance is 2.7V to 4.85V. Operating input voltage above 4.85V is possible with SGM66057A, however, the full performance is not guaranteed beyond the 4.85V operation. When the input supply voltage is larger than 5.3V, the device is shut down. An inductor, an output storage capacitor and an input decoupling capacitor should be selected to ensure the proper performance desired in a specific application circuit. The SGM66057A offers MODE configuration for FPWM operation or light load PFM operation.

### Startup and Enable

The SGM66057A implements the enable input to control the turn-on and turn-off of the device. A logic signal above 1.3V applied on EN pin turns on the device, and a logic signal below 0.4V turns off the device.

The SGM66057A has built-in 500 $\mu$ s (TYP) soft-start time. After enabling, the SGM66057A enters linear pre-charge phase with a limited current of 200mA. As the output voltage reaches the input voltage, the pre-charge phase terminates. The SGM66057A starts switching and boosts the output voltage to the 5.0V fixed output. This startup sequence effectively reduces the inrush current during startup.

The SGM66057A has a built-in 0.01 $\mu$ A (TYP) pull-down current when the EN pin is programmed to logic low. In addition to this pull-down current, there is an additional 300k $\Omega$  pull-down resistor when EN pin is logic low. When EN pin is programmed to logic high, the 300k $\Omega$  pull-down resistor is switched off and only the 0.01 $\mu$ A (TYP) pull-down current remains.

### MODE

The SGM66057A implements MODE pin to configure light load operation. When the MODE pin is pulled to logic low, the device operates in auto PFM mode to maximize efficiency at light load. When the MODE pin is pulled to logic high, the device operates in FPWM mode with a constant switching frequency throughout the entire operating load range.

### Current Limit and Short-Circuit

The SGM66057A has a built-in 3.45A (TYP) current limit. When inductor current exceeds the valley current limit, output voltage will fall to maintain a constant power operation. As output voltage drops below the

input voltage, current limit is reduced to 200mA (TYP) to minimize excessive power dissipation within the IC.

When an output short to ground event occurs, the SGM66057A reduces the current limit to 200mA (TYP) to prevent damage to the device. The SGM66057A resumes operation and goes through the startup sequence once the short-circuit condition is removed. Please refer to Figure 3 below:

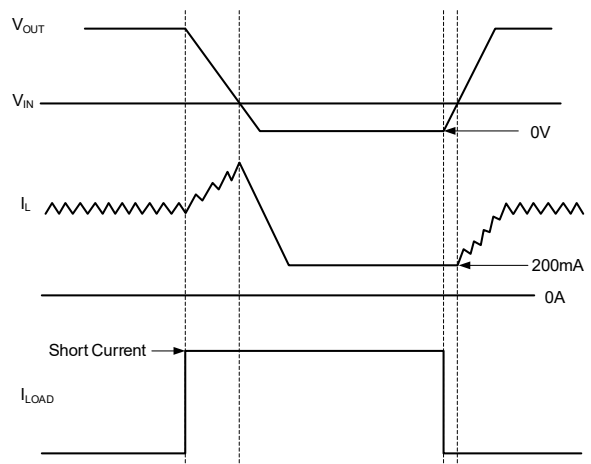

Figure 3. Short-Circuit Protection and Recovery

### Inductor Selection

Inductor is an essential element for current DC/DC switch mode power supplies regardless of topology. Inductor serves as the energy storage element for power conversion. Inductance and saturation current of inductor are two most important criterions for inductor selection. For general design guidance, the selected inductance should provide a peak to peak ripple current that is around 30% of the average inductor current at full load and nominal input voltage. The average inductor current for a Boost converter is the input current. Equation 1 shows the calculation of inductance selection, where  $f_{SW}$  is the switching frequency and  $\Delta I_L$  is the inductor ripple current.

$$L = \frac{V_{IN} \times (V_{OUT} - V_{IN})}{\Delta I_L \times f_{SW} \times V_{OUT}} \quad (1)$$

The 3.45A (TYP) valley current limit and the inductor current ripple should be considered when selecting the saturation current of the inductor.

The inductor also affects the close loop response of the DC/DC converter. The SGM66057A is an internally compensated device, and the loop response is optimized for inductor in the range of 0.33 $\mu$ H to 1.3 $\mu$ H.

**APPLICATION INFORMATION (continued)**

**Input Capacitor**

Boost converter’s input capacitor has continuous current throughout the entire switching cycle, a 10µF ceramic capacitor is recommended to place as close as possible between the VIN pin and GND pin of the device. For applications where the SGM66057A is located far away from the input source, a 47µF or higher capacitance capacitor is recommended to damp the wiring harness inductance.

**Output Capacitor**

The output capacitors of Boost converter dictate the output voltage ripple and load transient response. Equation 2 is used to estimate the necessary capacitance to achieve desired output voltage ripple, where ΔV is the maximum allowed ripple.

$$C_{MIN} = \frac{I_{OUT} \times (V_{OUT} - V_{IN})}{f_{SW} \times \Delta V \times V_{OUT}} \quad (2)$$

Since SGM66057A is an internally compensated device, the loop response is optimized for capacitor in the range of 10µF to 47µF. Due to the DC bias nature of ceramic capacitors, care should be taken by verifying manufacturer’s datasheet to ensure enough effective capacitance at desired output voltage.

**Layout Considerations**

In addition to component selection, layout is a critical step to ensure the performance of any switch mode

power supplies. Poor layout could result in system instability, EMI failure, and device damage. Thus, place the inductor, input and output capacitors as close to the IC as possible, and use wide and short traces for current carrying traces to minimize PCB inductance.

For Boost converter, the current loop of the output capacitor from VOUT pin back to the PGND pin of the device should be as small as possible.

**Layout Example**

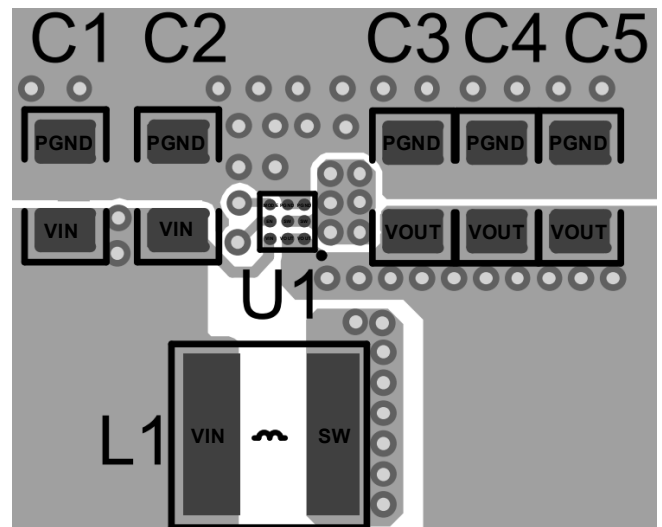

Figure 4. SGM66057A PCB Layout

**REVISION HISTORY**

NOTE: Page numbers for previous revisions may differ from page numbers in the current version.

<b>JUNE 2024 – REV.A to REV.A.1</b>	<b>Page</b>
Updated the Electrical Characteristics section .....	4

---

<b>Changes from Original (FEBRUARY 2024) to REV.A</b>	<b>Page</b>
Changed from product preview to production data.....	All

---

# PACKAGE INFORMATION

## PACKAGE OUTLINE DIMENSIONS

### WLCSP-1.26×1.21-9B

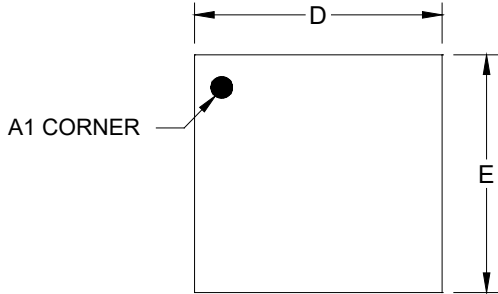

TOP VIEW

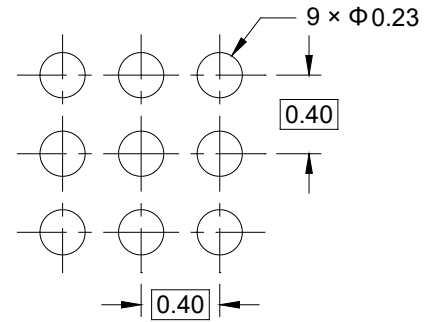

RECOMMENDED LAND PATTERN (Unit: mm)

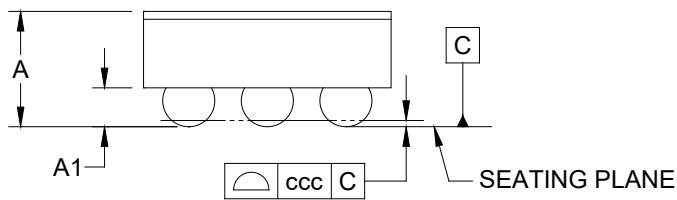

SIDE VIEW

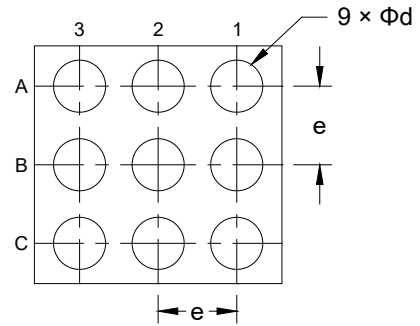

BOTTOM VIEW

Symbol	Dimensions In Millimeters		
	MIN	MOD	MAX
A	-	-	0.625
A1	0.178	-	0.218
D	1.230	-	1.290
E	1.180	-	1.240
d	0.235	-	0.295
e	0.400 BSC		
ccc	0.050		

NOTE: This drawing is subject to change without notice.

# PACKAGE INFORMATION

## TAPE AND REEL INFORMATION

### REEL DIMENSIONS



### TAPE DIMENSIONS



NOTE: The picture is only for reference. Please make the object as the standard.

### KEY PARAMETER LIST OF TAPE AND REEL

Package Type	Reel Diameter	Reel Width W1 (mm)	A0 (mm)	B0 (mm)	K0 (mm)	P0 (mm)	P1 (mm)	P2 (mm)	W (mm)	Pin1 Quadrant
WLCSP-1.26×1.21-9B	7"	9.5	1.35	1.35	0.73	4.0	4.0	2.0	8.0	Q1

000001

# PACKAGE INFORMATION

## CARTON BOX DIMENSIONS



NOTE: The picture is only for reference. Please make the object as the standard.

## KEY PARAMETER LIST OF CARTON BOX

Reel Type	Length (mm)	Width (mm)	Height (mm)	Pizza/Carton
7" (Option)	368	227	224	8
7"	442	410	224	18

DD0002