

GENERAL DESCRIPTION

The SGM9113 is a single rail-to-rail 5th-order output reconstruction filter which can operate from 3.0V to 5.5V single power supply, while consuming an ultra-low 6mA quiescent current. The device is optimized for low power, battery-operated applications.

The device has a -3dB bandwidth of 8MHz and 35V/ μ s slew rate, allowing DC-coupled output. An internal level shift circuit avoids synchronous pulse limit.

The SGM9113 is available in Green SOIC-8 and SC70-5 packages. It operates over an ambient temperature range of -40°C to +85°C.

FEATURES

- **Supply Voltage Range: 3.0V to 5.5V**
- **5th-Order Reconstruction Filter**
- **Internal Gain: 6dB**
- **Quiescent Current: 6mA (TYP)**
- **Rail-to-Rail Output**
- **-40°C to +85°C Operating Temperature Range**
- **Available in Green SOIC-8 and SC70-5 Packages**

APPLICATIONS

Video Amplifiers
Video Recorders
Video on Demand (VOD)
Cable and Satellite Set-Top Boxes
Portable and Handheld Products
Communication Devices
TVs

BLOCK DIAGRAM

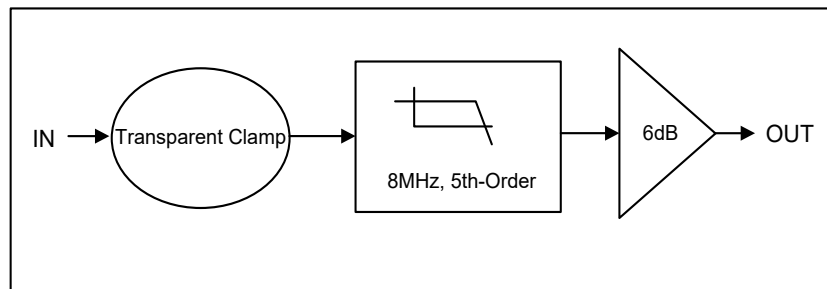

PACKAGE/ORDERING INFORMATION

MODEL	PACKAGE DESCRIPTION	SPECIFIED TEMPERATURE RANGE	ORDERING NUMBER	PACKAGE MARKING	PACKING OPTION
SGM9113	SOIC-8	-40°C to +85°C	SGM9113YS8G/TR	SGM9113YS8 XXXXX	Tape and Reel, 2500
	SC70-5	-40°C to +85°C	SGM9113YC5G/TR	S23XX	Tape and Reel, 3000

MARKING INFORMATION

NOTE: XX = Date Code. XXXXX = Date Code and Vendor Code.

SOIC-8

XXXXX

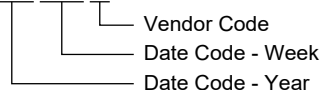

SC70-5

YYY X X

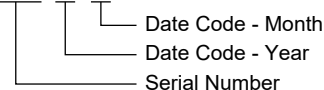

Green (RoHS & HSF): SG Micro Corp defines "Green" to mean Pb-Free (RoHS compatible) and free of halogen substances. If you have additional comments or questions, please contact your SGMICRO representative directly.

ABSOLUTE MAXIMUM RATINGS

- Input Voltage Range GND - 0.3V to V_{CC} + 0.3V
- Supply Voltage, V_{CC}..... 6.0V
- Junction Temperature +150°C
- Storage Temperature Range..... -65°C to +150°C
- Lead Temperature (Soldering, 10s) +260°C
- ESD Susceptibility
- HBM..... 8000V
- MM..... 400V
- CDM 2000V

RECOMMENDED OPERATING CONDITIONS

- Operating Voltage Range..... 3.0V to 5.5V
- Operating Temperature Range -40°C to +85°C

OVERSTRESS CAUTION

Stresses beyond those listed in Absolute Maximum Ratings may cause permanent damage to the device. Exposure to absolute maximum rating conditions for extended periods may affect reliability. Functional operation of the device at any conditions beyond those indicated in the Recommended Operating Conditions section is not implied.

ESD SENSITIVITY CAUTION

This integrated circuit can be damaged if ESD protections are not considered carefully. SGMICRO recommends that all integrated circuits be handled with appropriate precautions. Failure to observe proper handling and installation procedures can cause damage. ESD damage can range from subtle performance degradation to complete device failure. Precision integrated circuits may be more susceptible to damage because even small parametric changes could cause the device not to meet the published specifications.

DISCLAIMER

SG Micro Corp reserves the right to make any change in circuit design, or specifications without prior notice.

PIN CONFIGURATIONS

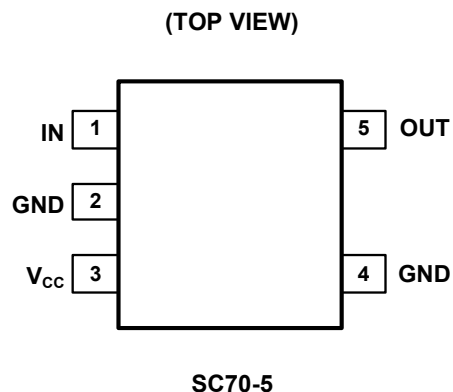
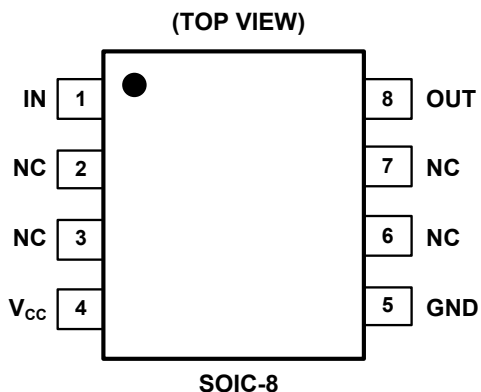

PIN DESCRIPTION

PIN		NAME	FUNCTION
SOIC-8	SC70-5		
1	1	IN	Signal Input.
5	2, 4	GND	Ground.
4	3	V _{CC}	Power Supply.
8	5	OUT	Signal Output.
2, 3, 6, 7	—	NC	No Connect.

ELECTRICAL CHARACTERISTICS

(At $V_{CC} = 5V$, $R_L = 150\Omega$ connected to GND, $V_{IN} = 1V_{PP}$ and $C_{IN} = 0.1\mu F$, output AC-coupled, referenced to 400kHz, unless otherwise noted.)

PARAMETER	CONDITIONS	TEMP	MIN	TYP	MAX	UNITS
Input Characteristics						
Output Level Shift Voltage (V_{OLS})	$V_{IN} = 0V$, No load	+25°C		340	570	mV
		-40°C to +85°C			675	
Input Voltage Clamp (V_{CLAMP})	$I_{IN} = -3.5mA$	+25°C	-285	-210		mV
		-40°C to +85°C	-390			
Clamp Charge Current	$V_{IN} = V_{CLAMP} - 100mV$	+25°C	-5.5	-4.8		mA
		-40°C to +85°C	-6.8			
Clamp Discharge Current	$V_{IN} = 500mV$	+25°C		1.9	2.7	μA
		-40°C to +85°C			3.2	
Voltage Gain (A_v)	$R_L = 150\Omega$	+25°C	5.6	6	6.4	dB
		-40°C to +85°C	5.55		6.45	
Output Characteristics						
Output Voltage High Swing	$V_{IN} = 3.0V$, $R_L = 150\Omega$ to GND	+25°C	4.6	4.79		V
		-40°C to +85°C	4.5			
Output Short-Circuit Current (I_{SC})	$V_{IN} = 1.5V$, Out shorted to GND through 10 Ω	+25°C	80	95		mA
		-40°C to +85°C	77			
	$V_{IN} = 0.5V$, Out shorted to V_{CC} through 10 Ω	+25°C		-102	-87	mA
		-40°C to +85°C			-78	
Power Supply						
Operating Voltage Range (V_{CC})		+25°C	3.0		5.5	V
Power Supply Rejection Ratio (PSRR)	$V_{CC} = 3.5V$ to 5.0V	+25°C	40	50		dB
		-40°C to +85°C	38			
Quiescent Current (I_Q)	$V_{IN} = 0.5V$	+25°C		6	9.5	mA
		-40°C to +85°C			11.5	
Dynamic Performance						
-0.1dB Bandwidth		+25°C		6		MHz
-3dB Bandwidth		+25°C		8		MHz
Filter Response (Normalized Gain)	$f_{IN} = 27MHz$	+25°C		47		dB
Slew Rate	2V Output step, 80% to 20%	+25°C		35		V/ μs
Differential Gain Error (DG)	PAL DC-coupled	+25°C		0.85		%
	PAL AC-coupled	+25°C		0.85		%
Differential Phase Error (DP)	PAL DC-coupled	+25°C		1		°
	PAL AC-coupled	+25°C		1.4		°
Group Delay Variation (D/DT)	Difference between 400kHz and 6.5MHz	+25°C		28		ns
Fall Time	2V Output step, 80% to 20%	+25°C		34		ns
Rise Time	2V Output step, 80% to 20%	+25°C		33		ns

TYPICAL PERFORMANCE CHARACTERISTICS

At $V_{CC} = 5V$, $T_A = +25^\circ C$, $R_L = 150\Omega$, output AC-coupled, unless otherwise noted.

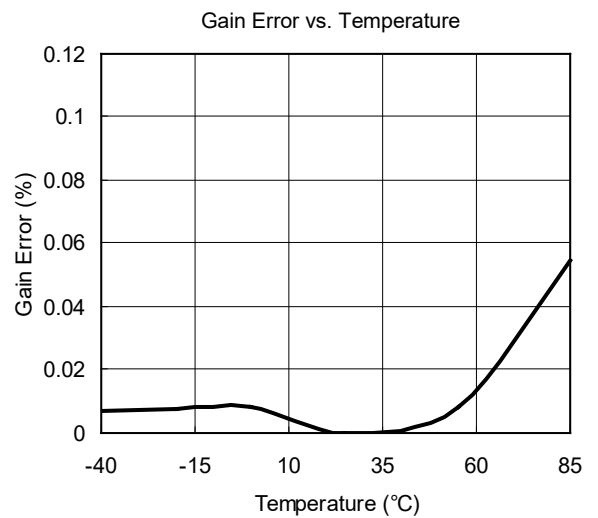
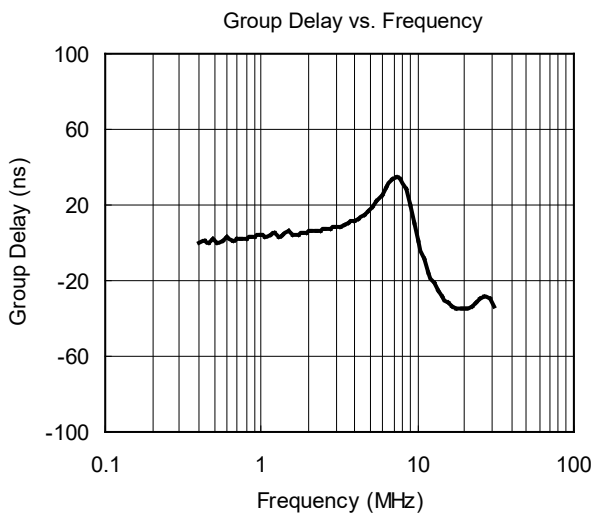
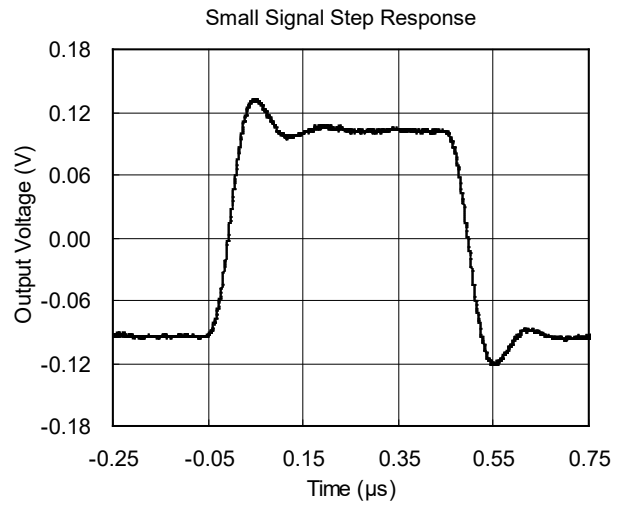
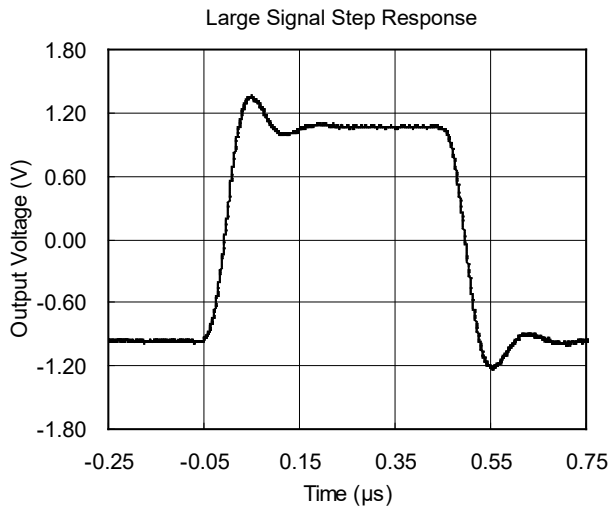
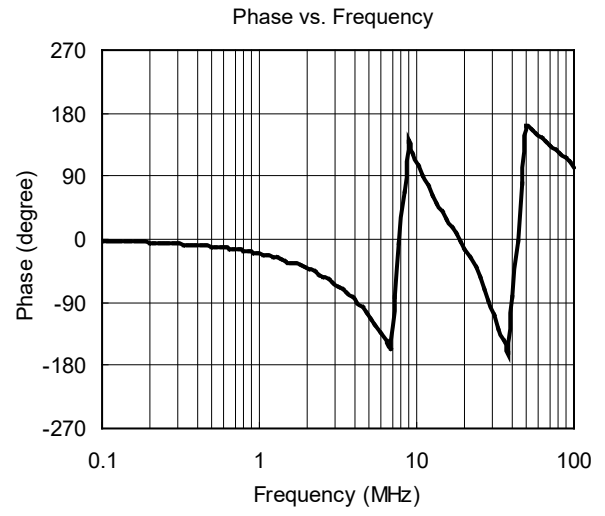
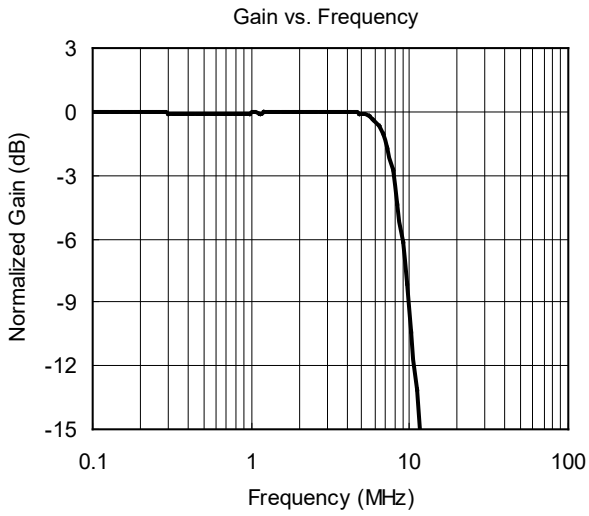

TYPICAL PERFORMANCE CHARACTERISTICS (continued)

At $V_{CC} = 5V$, $T_A = +25^\circ C$, $R_L = 150\Omega$, output AC-coupled, unless otherwise noted.

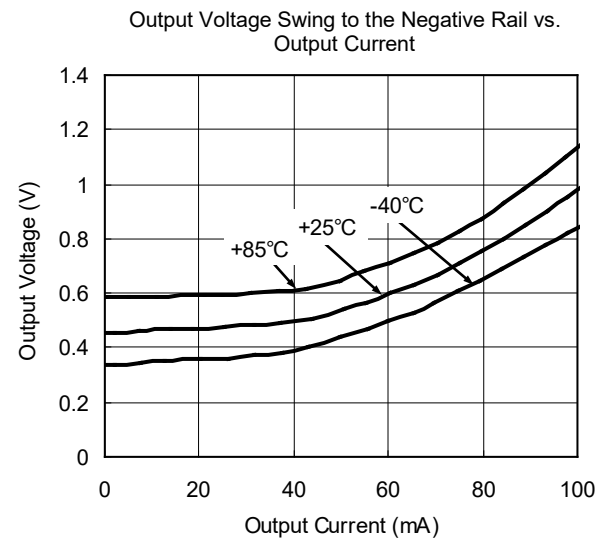
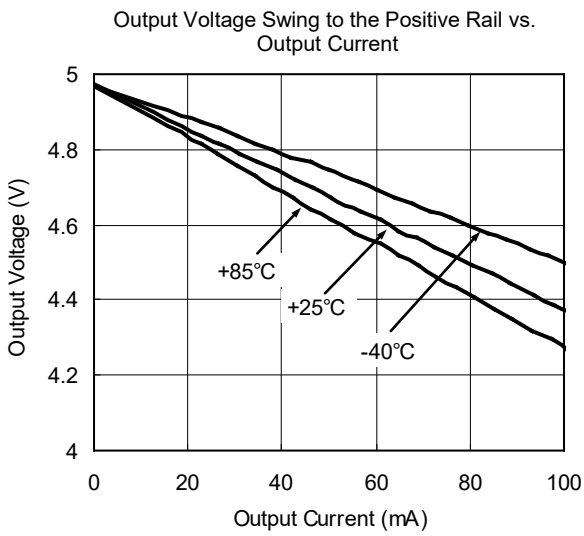
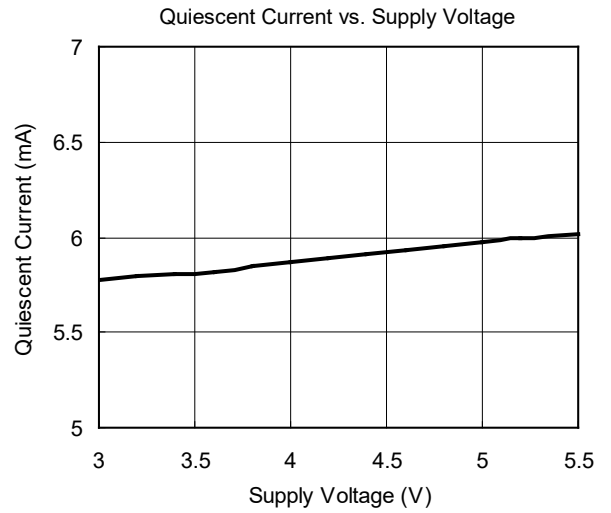
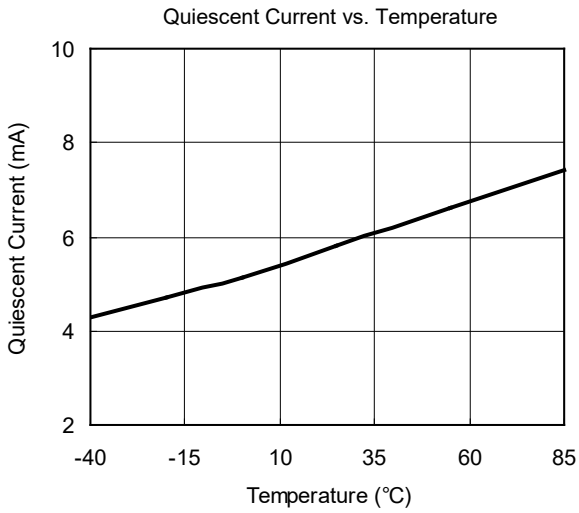

PACKAGE OUTLINE DIMENSIONS

SOIC-8

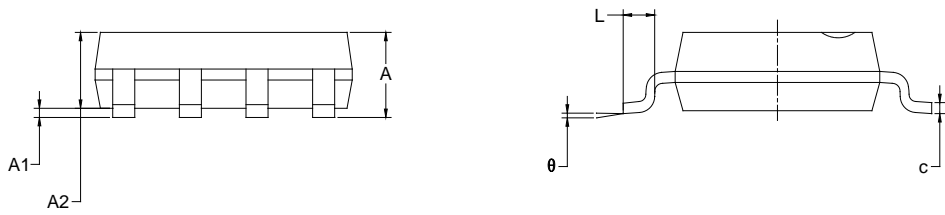
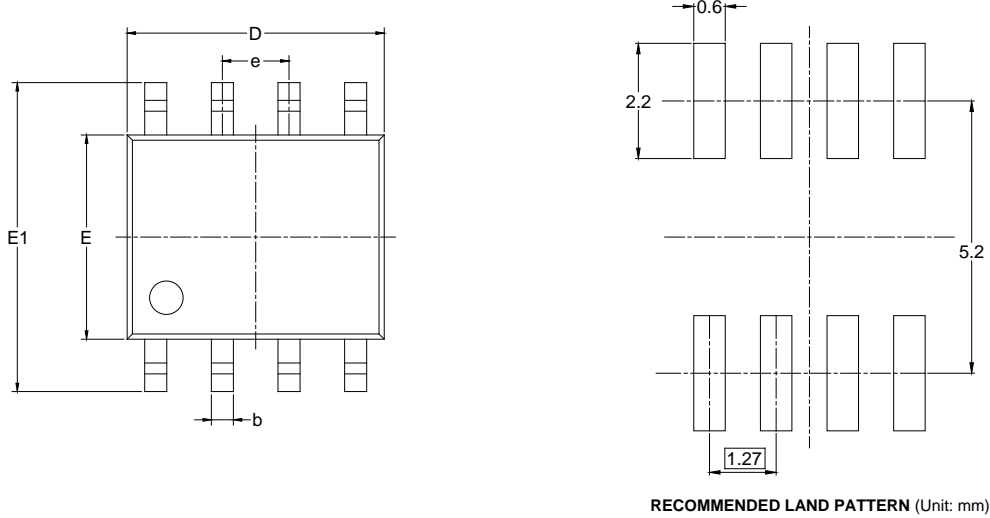

Symbol	Dimensions In Millimeters		Dimensions In Inches	
	MIN	MAX	MIN	MAX
A	1.350	1.750	0.053	0.069
A1	0.100	0.250	0.004	0.010
A2	1.350	1.550	0.053	0.061
b	0.330	0.510	0.013	0.020
c	0.170	0.250	0.006	0.010
D	4.700	5.100	0.185	0.200
E	3.800	4.000	0.150	0.157
E1	5.800	6.200	0.228	0.244
e	1.27 BSC		0.050 BSC	
L	0.400	1.270	0.016	0.050
θ	0°	8°	0°	8°

NOTES:
 1. Body dimensions do not include mode flash or protrusion.
 2. This drawing is subject to change without notice.

PACKAGE OUTLINE DIMENSIONS

SC70-5

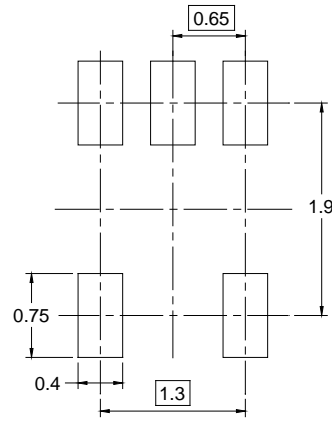
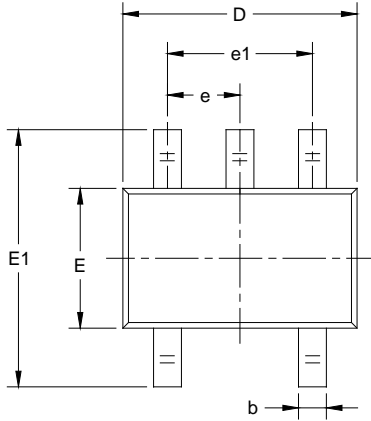

RECOMMENDED LAND PATTERN (Unit: mm)

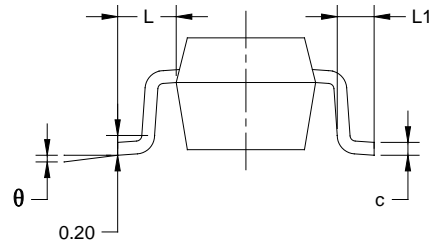
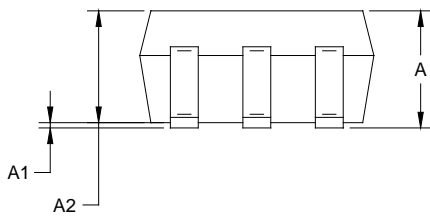

Symbol	Dimensions In Millimeters		Dimensions In Inches	
	MIN	MAX	MIN	MAX
A	0.800	1.100	0.031	0.043
A1	0.000	0.100	0.000	0.004
A2	0.800	1.000	0.031	0.039
b	0.150	0.350	0.006	0.014
c	0.080	0.220	0.003	0.009
D	2.000	2.200	0.079	0.087
E	1.150	1.350	0.045	0.053
E1	2.150	2.450	0.085	0.096
e	0.65 TYP		0.026 TYP	
e1	1.300 BSC		0.051 BSC	
L	0.525 REF		0.021 REF	
L1	0.260	0.460	0.010	0.018
θ	0°	8°	0°	8°

NOTES:

1. Body dimensions do not include mode flash or protrusion.
2. This drawing is subject to change without notice.

TAPE AND REEL INFORMATION

REEL DIMENSIONS



TAPE DIMENSIONS



NOTE: The picture is only for reference. Please make the object as the standard.

KEY PARAMETER LIST OF TAPE AND REEL

Package Type	Reel Diameter	Reel Width W1 (mm)	A0 (mm)	B0 (mm)	K0 (mm)	P0 (mm)	P1 (mm)	P2 (mm)	W (mm)	Pin1 Quadrant
SOIC-8	13"	12.4	6.40	5.40	2.10	4.0	8.0	2.0	12.0	Q1
SC70-5	7"	9.5	2.25	2.55	1.20	4.0	4.0	2.0	8.0	Q3

000001

PACKAGE INFORMATION

CARTON BOX DIMENSIONS



NOTE: The picture is only for reference. Please make the object as the standard.

KEY PARAMETER LIST OF CARTON BOX

Reel Type	Length (mm)	Width (mm)	Height (mm)	Pizza/Carton
7" (Option)	368	227	224	8
7"	442	410	224	18
13"	386	280	370	5

DD0002