



SGM8902

Capless 2Vrms to 3Vrms Line Driver with Adjustable Gain

GENERAL DESCRIPTION

The SGM8902 is a 2Vrms to 3Vrms pop/click-free stereo line driver. The device is ideal for single supply applications. Capless design can eliminate output DC-blocking capacitors for less-component count and low-cost.

The SGM8902 has differential inputs and is capable of driving 2Vrms into a 2.5k Ω load with 3.3V supply voltage. Build-in shutdown control also helps for pop/click-free on/off control. The gain can be set by users from $\pm 1V/V$ to $\pm 10V/V$ through external gain setting resistors that also allows the implementation of a 2nd-order low pass filter to compliment SOC and DAC's converters.

SGM8902 does not require a power supply. An integrated charge pump generates a 2Vrms output negative power rail that provides a clean, pop/click-free ground offset.

The SGM8902 is available in a Green TSSOP-14 package. It operates over an ambient temperature range of -40°C to +85°C.

FEATURES

- **Supply Voltage Range: 3V to 5.5V**
- **Output Voltage into 2.5k Ω Load**
 - ◆ 2Vrms at 3.3V Supply Voltage
 - ◆ 3Vrms at 5V Supply Voltage
- **Capless Structure**
 - ◆ Pop/Click-Free
 - ◆ Eliminates Output DC-Blocking Capacitors
 - ◆ Provides Flat Frequency Response
- **Differential Inputs**
- **Low Noise and THD**
 - ◆ SNR = 114dB (TYP)
 - ◆ $V_N = 5.5\mu V_{rms}$ (TYP)
 - ◆ THD+N = 0.001% (f = 1kHz)
- **-40°C to +85°C Operating Temperature Range**
- **Available in a Green TSSOP-14 Package**

APPLICATIONS

LCD TV
Set-Top Box
Home Theater
Blue-Ray DVD-Players

PACKAGE/ORDERING INFORMATION

MODEL	PACKAGE DESCRIPTION	SPECIFIED TEMPERATURE RANGE	ORDERING NUMBER	PACKAGE MARKING	PACKING OPTION
SGM8902	TSSOP-14	-40°C to +85°C	SGM8902YTS14G/TR	SGM8902 YTS14 XXXXX	Tape and Reel, 3000

NOTE: XXXXX = Date Code and Vendor Code.

Green (RoHS & HSF): SG Micro Corp defines "Green" to mean Pb-Free (RoHS compatible) and free of halogen substances. If you have additional comments or questions, please contact your SGMICRO representative directly.

ABSOLUTE MAXIMUM RATINGS

Supply Voltage..... -0.3V to 6V
 Input Voltage..... $V_{SS} - 0.3V$ to $V_{DD} + 0.3V$
 Minimum Load Impedance (R_L)600Ω
 EN to GND.....-0.3V to $V_{DD} + 0.3V$
 Junction Temperature+150°C
 Storage Temperature Range.....-65°C to +150°C
 Lead Temperature (Soldering, 10s)+260°C
 ESD Susceptibility
 HBM..... 6000V
 MM..... 300V
 CDM 1000V

RECOMMENDED OPERATING CONDITIONS

Supply Voltage Range3V to 5.5V
 Operating Temperature Range-40°C to +85°C

OVERSTRESS CAUTION

Stresses beyond those listed in Absolute Maximum Ratings may cause permanent damage to the device. Exposure to absolute maximum rating conditions for extended periods may affect reliability. Functional operation of the device at any conditions beyond those indicated in the Recommended Operating Conditions section is not implied.

ESD SENSITIVITY CAUTION

This integrated circuit can be damaged if ESD protections are not considered carefully. SGMICRO recommends that all integrated circuits be handled with appropriate precautions. Failure to observe proper handling and installation procedures can cause damage. ESD damage can range from subtle performance degradation to complete device failure. Precision integrated circuits may be more susceptible to damage because even small parametric changes could cause the device not to meet the published specifications.

DISCLAIMER

SG Micro Corp reserves the right to make any change in circuit design, or specifications without prior notice.

TYPICAL OPERATION CIRCUIT

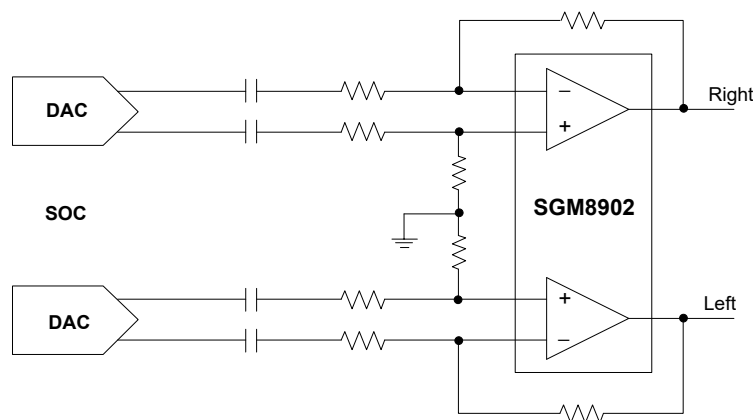

PIN CONFIGURATION

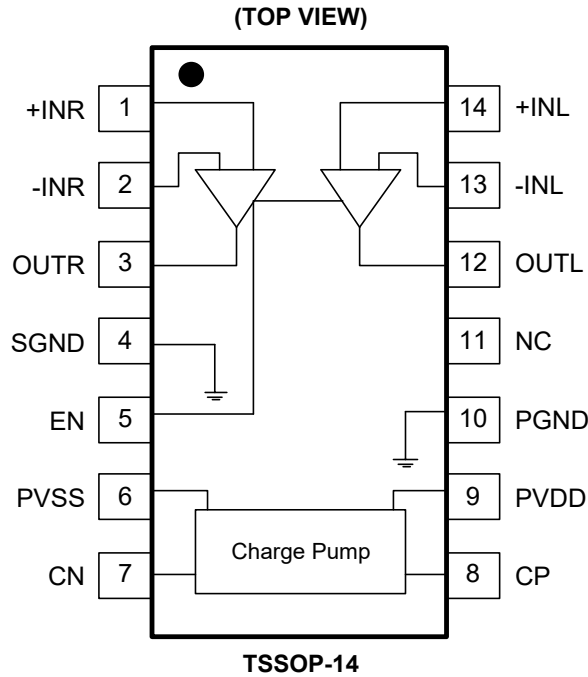

PIN DESCRIPTION

PIN	NAME	FUNCTION
1	+INR	Positive Input for Right Channel OPAMP.
2	-INR	Negative Input for Right Channel OPAMP.
3	OUTR	Output for Right Channel OPAMP.
4	SGND	Signal Ground.
5	EN	Enable Input. Active High.
6	PVSS	Negative Supply Voltage Output.
7	CN	Negative Terminal for Charge Pump Flying Capacitor.
8	CP	Positive Terminal for Charge Pump Flying Capacitor.
9	PVDD	Positive Supply.
10	PGND	Power Ground.
11	NC	No Internal Connection.
12	OUTL	Output for Left Channel OPAMP.
13	-INL	Negative Input for Left Channel OPAMP.
14	+INL	Positive Input for Left Channel OPAMP.

ELECTRICAL CHARACTERISTICS

(T_A = +25°C, unless otherwise noted.)

PARAMETER	CONDITIONS	MIN	TYP	MAX	UNITS
Electrical Characteristics					
DC Supply Voltage (V _{DD})		3		5.5	V
Output Offset Voltage (V _{OS})	V _{DD} = 3V to 5V		1.2	5	mV
Power Supply Rejection Ratio (PSRR)	V _{DD} = 3V to 5V		97		dB
High-Level Output Voltage (V _{OH})	V _{DD} = 3.3V, R _L = 2.5kΩ	3.18			V
Low-Level Output Voltage (V _{OL})	V _{DD} = 3.3V, R _L = 2.5kΩ			-3.05	V
High-Level Input Current (EN) (I _{IH})	V _{DD} = 5V, V _I = V _{DD}			1	μA
Low-Level Input Current (EN) (I _{IL})	V _{DD} = 5V, V _I = 0V			1	μA
Supply Current (I _{DD})	V _{DD} = 3.3V, No load, EN = V _{DD}		10.5	14.5	mA
	V _{DD} = 5V, No load, EN = V _{DD}		11.3	15.5	
	Shutdown mode, V _{DD} = 3V to 5V		0.13	0.18	
Operating Characteristics (V _{DD} = 3.3V, R _L = 2.5kΩ, C _{PUMP} = C _{PVSS} = 1μF, C _{IN} = 10μF, R _{IN} = 10kΩ, R _{FB} = 20kΩ.) ⁽¹⁾					
Output Voltage (Outputs in Phase) (V _O)	THD = 1%, V _{DD} = 3.3V, f = 1kHz	2.05			Vrms
	THD = 1%, V _{DD} = 5V, f = 1kHz	3.05			
	THD = 1%, V _{DD} = 5V, f = 1kHz, R _L = 100kΩ	3.1			
Total Harmonic Distortion Plus Noise (THD+N)	V _O = 2Vrms, f = 1kHz		0.001		%
Crosstalk	V _O = 2Vrms, f = 1kHz		113		dB
Output Current Limit (I _O)	V _{DD} = 3.3V		20		mA
Input Resistor Range (R _{IN})			10		kΩ
Feedback Resistor Range (R _{FB})			20		kΩ
Slew Rate			10		V/μs
Maximum Capacitive Load			220		pF
Noise Output Voltage (V _N)	A-weighted, BW = 20kHz		5.5		μVrms
Signal to Noise Ratio (SNR)	V _O = 3Vrms, THD+N = 0.1%, BW = 20kHz, A-weighted		114		dB
Unity Gain Bandwidth (G _{BW})			7.8		MHz
Open-Loop Voltage Gain (A _{VO})			120		dB
Charge Pump Frequency (F _{CP})		330	450	560	kHz
EN Pin					
Input High Voltage (V _{INH})	EN	1.2			V
Input Low Voltage (V _{INL})	EN			0.6	V

TYPICAL PERFORMANCE CHARACTERISTICS

$V_{DD} = 3.3V$, $T_A = +25^\circ C$, $R_L = 2.5k\Omega$, $C_{PUMP} = C_{PVSS} = 1\mu F$, $C_{IN} = 10\mu F$, $R_{IN} = 10k\Omega$, $R_{FB} = 20k\Omega$, unless otherwise noted.

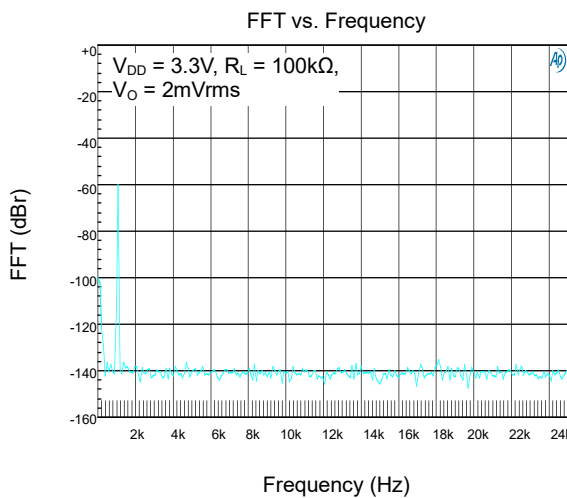
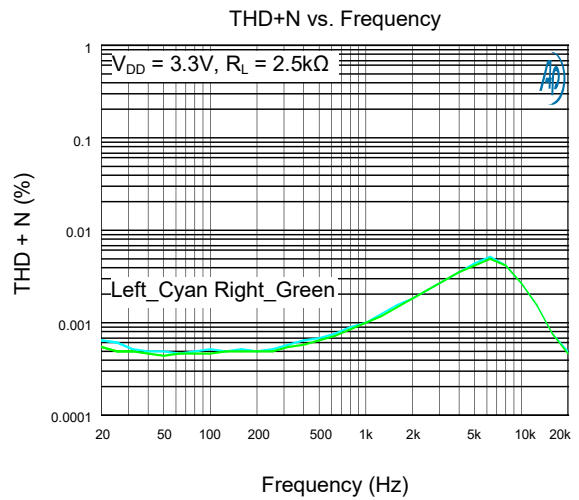
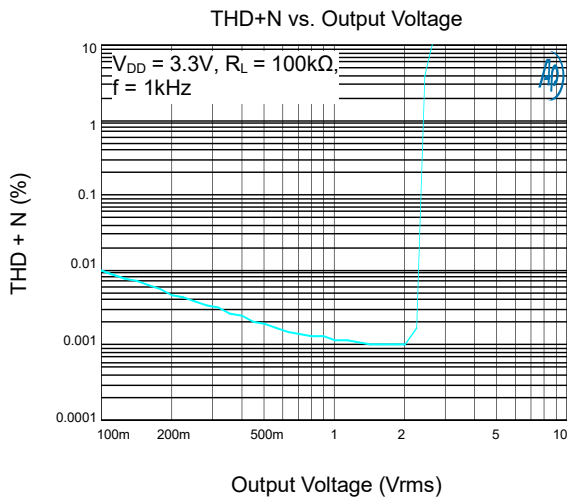
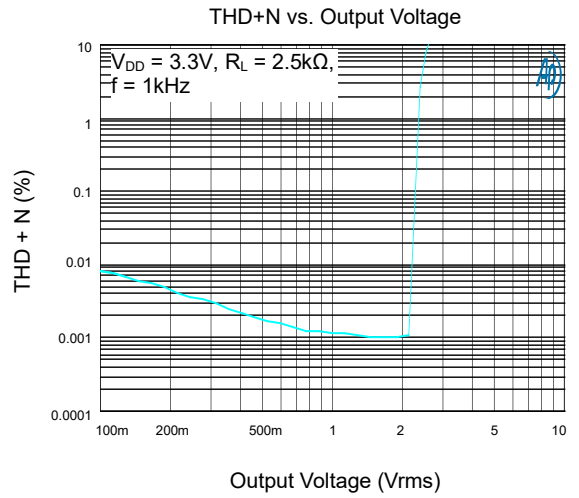
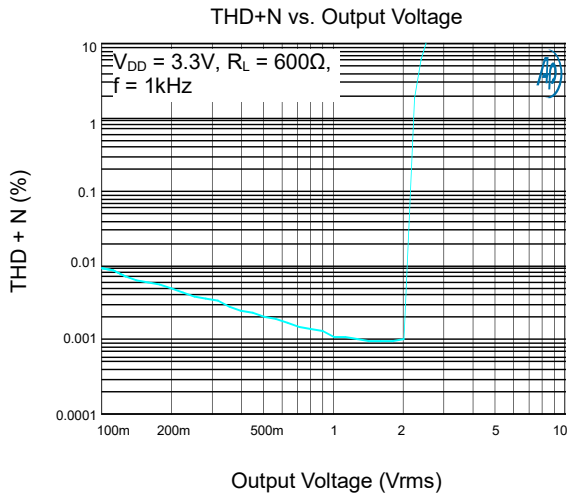

TYPICAL PERFORMANCE CHARACTERISTICS (continued)

$V_{DD} = 3.3V$, $T_A = +25^\circ C$, $R_L = 2.5k\Omega$, $C_{PUMP} = C_{PVSS} = 1\mu F$, $C_{IN} = 10\mu F$, $R_{IN} = 10k\Omega$, $R_{FB} = 20k\Omega$, unless otherwise noted.

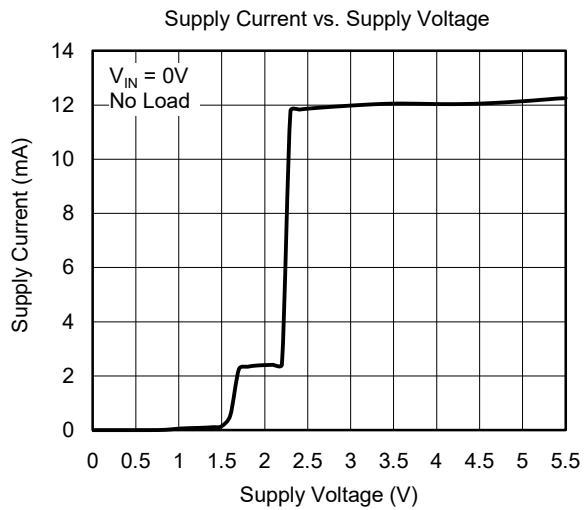
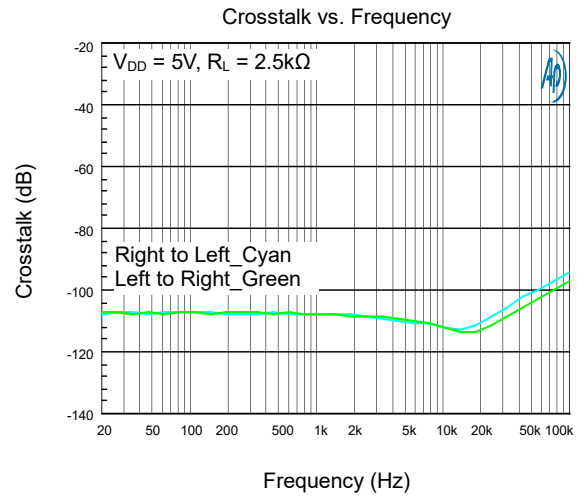
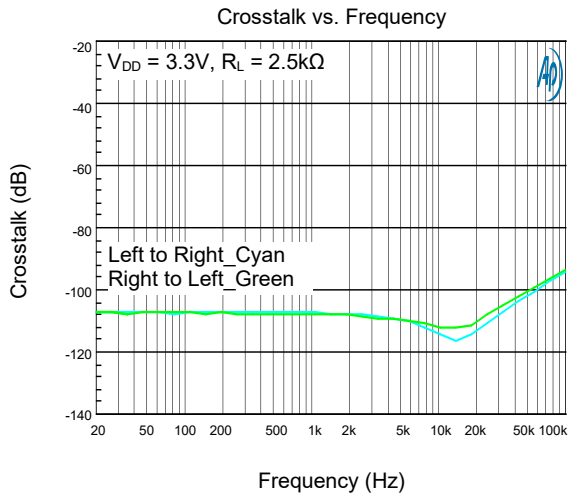

PACKAGE OUTLINE DIMENSIONS

TSSOP-14

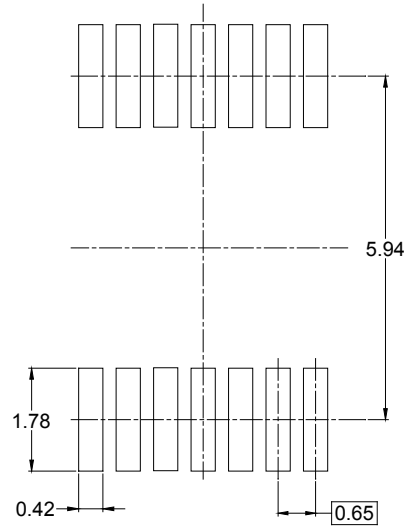
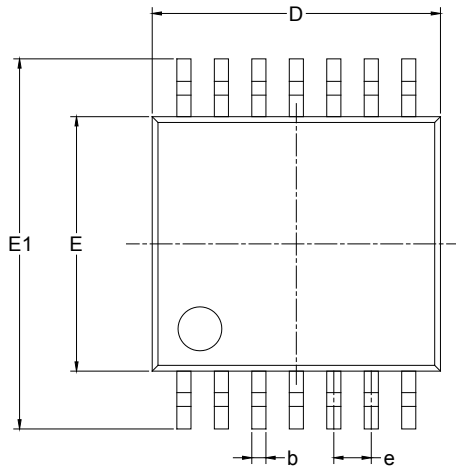

RECOMMENDED LAND PATTERN (Unit: mm)

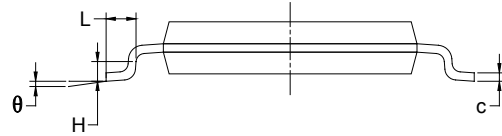
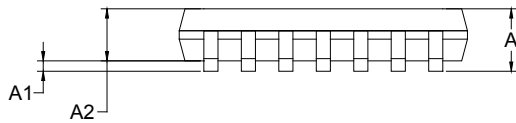

Symbol	Dimensions In Millimeters		Dimensions In Inches	
	MIN	MAX	MIN	MAX
A		1.200		0.047
A1	0.050	0.150	0.002	0.006
A2	0.800	1.050	0.031	0.041
b	0.190	0.300	0.007	0.012
c	0.090	0.200	0.004	0.008
D	4.860	5.100	0.191	0.201
E	4.300	4.500	0.169	0.177
E1	6.250	6.550	0.246	0.258
e	0.650 BSC		0.026 BSC	
L	0.500	0.700	0.02	0.028
H	0.25 TYP		0.01 TYP	
θ	1°	7°	1°	7°

TAPE AND REEL INFORMATION

REEL DIMENSIONS



TAPE DIMENSIONS



NOTE: The picture is only for reference. Please make the object as the standard.

KEY PARAMETER LIST OF TAPE AND REEL

Package Type	Reel Diameter	Reel Width W1 (mm)	A0 (mm)	B0 (mm)	K0 (mm)	P0 (mm)	P1 (mm)	P2 (mm)	W (mm)	Pin1 Quadrant
TSSOP-14	13"	12.4	6.95	5.60	1.20	4.0	8.0	2.0	12.0	Q1

000001

PACKAGE INFORMATION

CARTON BOX DIMENSIONS



NOTE: The picture is only for reference. Please make the object as the standard.

KEY PARAMETER LIST OF CARTON BOX

Reel Type	Length (mm)	Width (mm)	Height (mm)	Pizza/Carton
13"	386	280	370	5

DD0002