

GENERAL DESCRIPTION

The SGM9128YP is a 4-channel, 5th-order output reconstruction filter which can operate from 3.1V to 5.5V single power supply. It is designed to replace passive LC filters and drivers with an integrated device. Compared with typical passive solutions, the four 6th-order Butterworth filters provide better image quality than typical passive solutions. One channel is Standard Definition (SD) filter while the rest three channels are High Definition (HDi) filters.

The device has a 6dB gain, allowing DC- or AC-coupled output. SGM9128YP can be DC-coupled or AC-coupled with input video signal to eliminate out-of-band noise, such as the output stage of DAC. Internal clamp circuitry may be used if AC-coupled inputs are required.

SGM9128YP is available in a Green MSOP-10 (Exposed Pad) package. It operates over an ambient temperature range of -40°C to +85°C.

FEATURES

- **Supply Voltage Range: 3.1V to 5.5V**
- **Three 6th-Order High Definition Filters**
- **One 6th-Order Standard Definition Filter**
- **Internal Gain: 6dB**
- **Clamp Mode Active with AC-Coupled Inputs**
- **Clamp Mode Inactive with DC-Coupled Inputs**
- **AC- or DC-Coupled Outputs**
- **DC-Coupled Outputs Eliminate AC-Coupled Capacitors**
- **-40°C to +85°C Operating Temperature Range**
- **Available in a Green MSOP-10 (Exposed Pad) Package**

APPLICATIONS

- Video on Demand (VOD)
- Set-Top Boxes
- Personal Video Recorders (PVR)
- TVs

BLOCK DIAGRAM

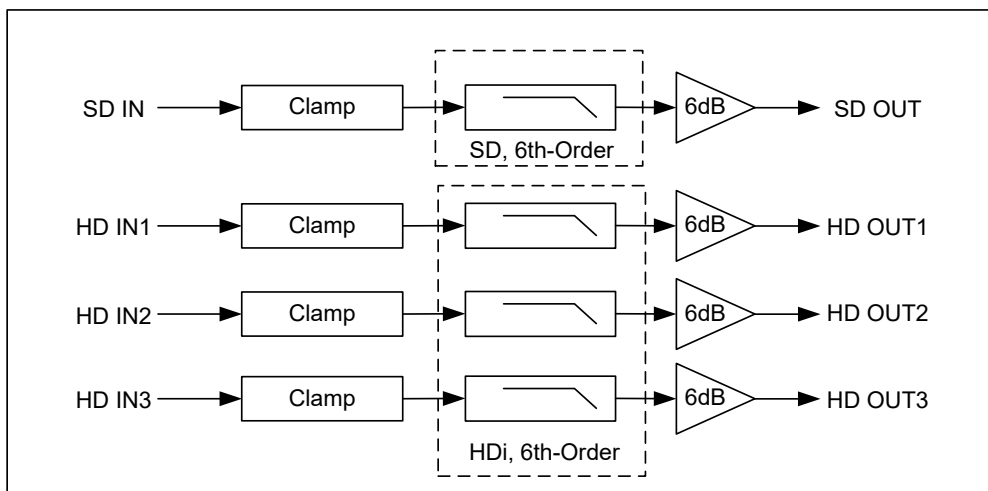

PACKAGE/ORDERING INFORMATION

MODEL	PACKAGE DESCRIPTION	SPECIFIED TEMPERATURE RANGE	ORDERING NUMBER	PACKAGE MARKING	PACKING OPTION
SGM9128YP	MSOP-10 (Exposed Pad)	-40°C to +85°C	SGM9128YPMS10G/TR	SGM9128 YPMS10 XXXXX	Tape and Reel, 3000

MARKING INFORMATION

NOTE: XXXXX = Date Code and Vendor Code.

XXXXX

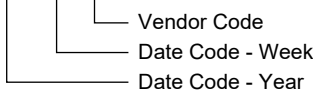

Green (RoHS & HSF): SG Micro Corp defines "Green" to mean Pb-Free (RoHS compatible) and free of halogen substances. If you have additional comments or questions, please contact your SGMICRO representative directly.

Analog and Digital Input/Output Voltage

- GND - 0.3V to V_{CC} + 0.3V
- DC Supply Voltage, V_{CC}..... 6.0V
- Junction Temperature 150°C
- Storage Temperature Range..... -65°C to +150°C
- Lead Temperature (Soldering, 10s) 260°C
- ESD Susceptibility
- HBM..... 8000V
- MM..... 400V

RECOMMENDED OPERATING CONDITIONS

- Operating Voltage Range..... 3.1V to 5.5V
- Operating Temperature Range -40°C to +85°C

OVERSTRESS CAUTION

Stresses beyond those listed in Absolute Maximum Ratings may cause permanent damage to the device. Exposure to absolute maximum rating conditions for extended periods may affect reliability. Functional operation of the device at any conditions beyond those indicated in the Recommended Operating Conditions section is not implied.

ESD SENSITIVITY CAUTION

This integrated circuit can be damaged if ESD protections are not considered carefully. SGMICRO recommends that all integrated circuits be handled with appropriate precautions. Failure to observe proper handling and installation procedures can cause damage. ESD damage can range from subtle performance degradation to complete device failure. Precision integrated circuits may be more susceptible to damage because even small parametric changes could cause the device not to meet the published specifications.

DISCLAIMER

SG Micro Corp reserves the right to make any change in circuit design, or specifications without prior notice.

PIN CONFIGURATION

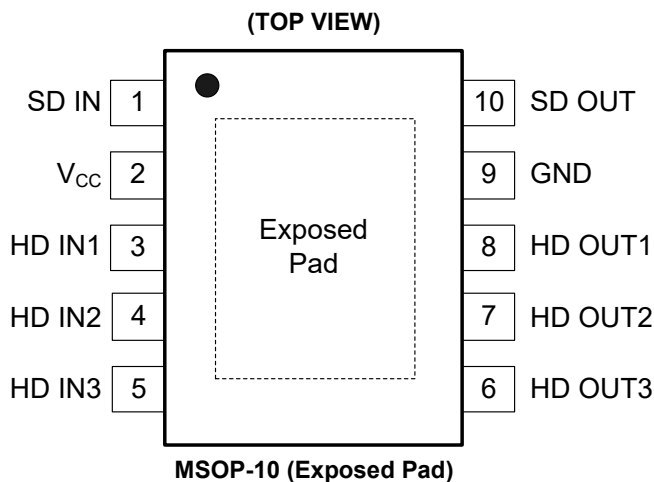

PIN DESCRIPTION

PIN	NAME	FUNCTION
1	SD IN	SD Video Input.
2	V _{CC}	Power Supply.
3	HD IN1	HD Video Input for Channel 1.
4	HD IN2	HD Video Input for Channel 2.
5	HD IN3	HD Video Input for Channel 3.
6	HD OUT3	Filtered HD Video Output for Channel 3.
7	HD OUT2	Filtered HD Video Output for Channel 2.
8	HD OUT1	Filtered HD Video Output for Channel 1.
9	GND	Ground.
10	SD OUT	Filtered SD Video Output.
Exposed Pad	—	Exposed Pad. Can only be connected to GND or left floating.

ELECTRICAL CHARACTERISTICS

($T_A = +25^\circ\text{C}$, $V_{IN} = 1V_{PP}$, $V_{CC} = 5V$, $R_{SOURCE} = 37.5\Omega$; all inputs are AC-coupled with $0.1\mu\text{F}$; all outputs are AC-coupled with $220\mu\text{F}$ into 150Ω , referenced to 400kHz , unless otherwise noted.)

PARAMETER	CONDITIONS	MIN	TYP	MAX	UNITS
DC Electrical Characteristics					
Operating Voltage Range (V_{CC})		3.1	5	5.5	V
Quiescent Current (I_Q)	$V_{CC} = 5.0V$, No load		65	84	mA
Output Level Shift Voltage (V_{OLS})	$V_{IN} = 0V$, No load		550	760	mV
Voltage Gain (A_V)	$R_L = 150\Omega$	5.8	6.1	6.35	dB
Output Voltage High Swing	$V_{IN} = 3V$, $R_L = 150\Omega$ to GND		4.8		V
Video Input Voltage Range	Referenced to GND if DC-coupled		1.4		V_{PP}
Power Supply Rejection Ratio (PSRR)	DC (All channels)		50		dB
Standard Definition Electrical Characteristics					
-0.1dB Bandwidth	SD channel		6.4		MHz
-1dB Bandwidth	SD channel		7.6		MHz
-3dB Bandwidth	SD channel		8.5		MHz
Filter Response (Normalized Gain)	SD channel, $f_{IN} = 400\text{kHz}$ to 27MHz		50		dB
Slew Rate	2V Output step, 80% to 20%		34		V/ μs
Differential Gain (DG)	AC-AC coupled, PAL/NTSC		0.9/0.5		%
	AC-DC coupled, PAL/NTSC		0.5/0.35		
Differential Phase (DP)	AC-AC coupled, PAL/NTSC		1/0.7		deg
	AC-DC coupled, PAL/NTSC		0.7/0.6		
Group Delay Variation (D/DT)	Difference between 400kHz and 6.5MHz		30		ns
Crosstalk (channel-to-channel)	$V_{OUT} = 1.4V_{PP}$, $f = 1\text{MHz}$		-61		dB
Signal-to-Noise Ratio (SNR)	NTC-7 weighting, 100kHz to 5MHz		75		dB
Fall Time	2V Output step, 80% to 20%		34		ns
Rise Time	2V Output step, 80% to 20%		36		ns
Chroma Luma Gain (CLG_{SD})	$f = 3.58\text{MHz}$ (Referenced to SD_{IN} at 400kHz)		102		%
Chroma Luma Delay (CLD_{SD})	$f = 3.58\text{MHz}$ (Referenced to SD_{IN} at 400kHz)		8		ns
1080i High Definition Electrical Characteristics					
-0.1dB Bandwidth	$R_L = 150\Omega$		32		MHz
-1dB Bandwidth	$R_L = 150\Omega$		39		MHz
-3dB Bandwidth	$R_L = 150\Omega$		46		MHz
Filter Response (Normalized Gain)	$f_{IN} = 400\text{kHz}$ to 74.25MHz		23		dB
Slew Rate	2V Output step, 80% to 20%		190		V/ μs
Group Delay Variation (D/DT)	Difference between 400kHz and 26MHz		2.5		ns
Crosstalk (channel-to-channel)	$V_{OUT} = 1.4V_{PP}$, $f = 1\text{MHz}$		-60		dB
Fall Time	2V Output step, 80% to 20%		6.2		ns
Rise Time	2V Output step, 80% to 20%		6.2		ns

TYPICAL PERFORMANCE CHARACTERISTICS

$T_A = +25^\circ\text{C}$, $V_{IN} = 1V_{PP}$, $V_{CC} = 5V$, $R_{SOURCE} = 37.5\Omega$; all inputs are AC-coupled with $0.1\mu\text{F}$; all outputs are AC-coupled with $220\mu\text{F}$ into 150Ω , referenced to 400kHz , unless otherwise noted.

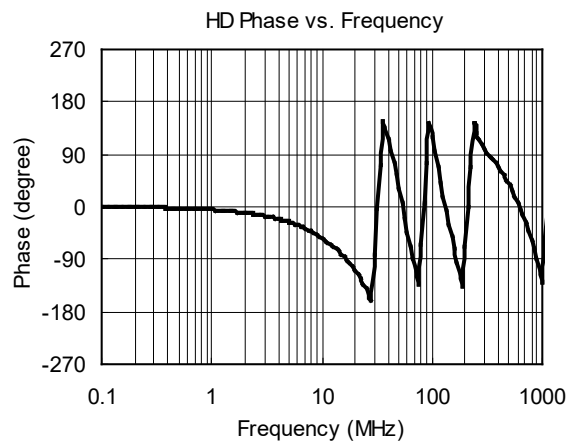
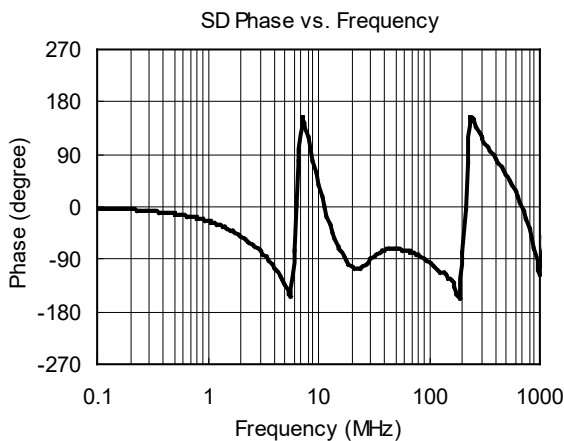
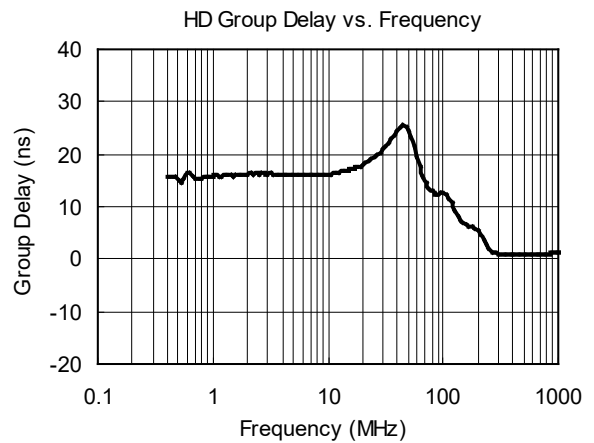
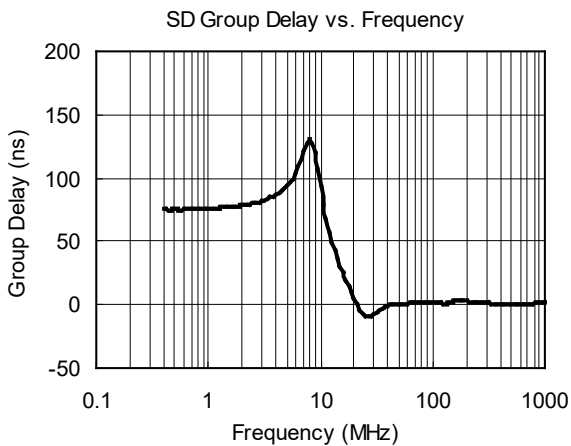
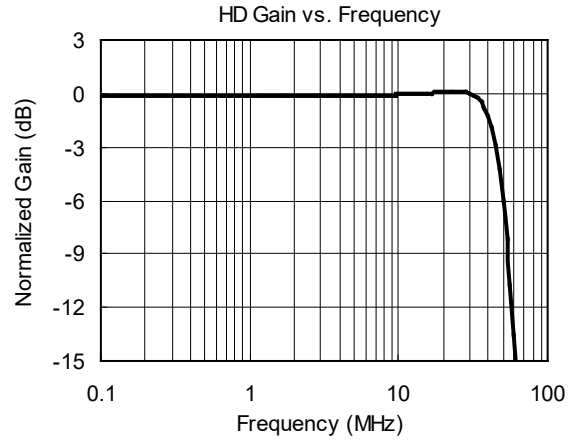
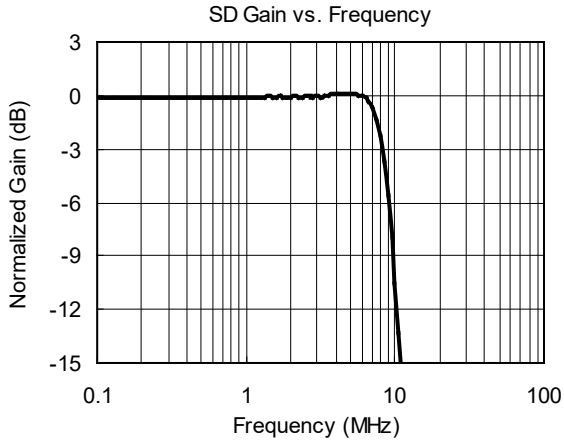

TYPICAL PERFORMANCE CHARACTERISTICS (continued)

$T_A = +25^\circ\text{C}$, $V_{IN} = 1V_{PP}$, $V_{CC} = 5V$, $R_{SOURCE} = 37.5\Omega$; all inputs are AC-coupled with $0.1\mu\text{F}$; all outputs are AC-coupled with $220\mu\text{F}$ into 150Ω , referenced to 400kHz , unless otherwise noted.

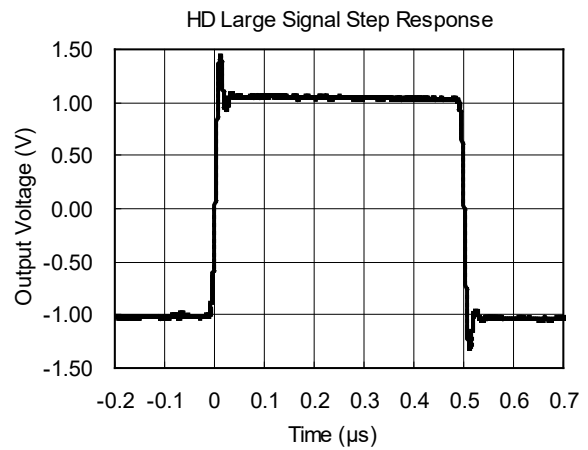
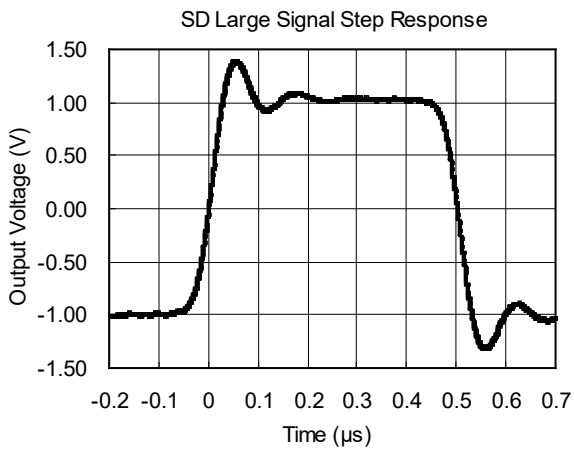
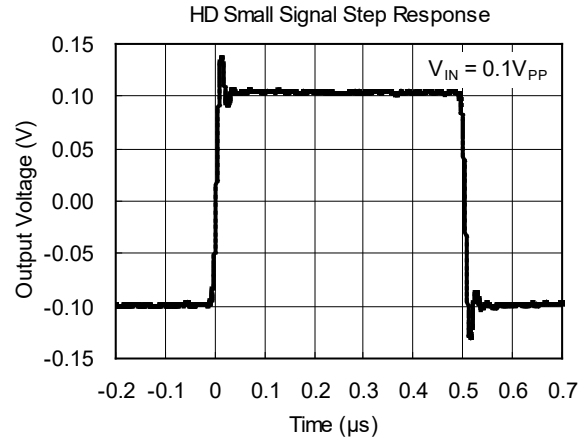
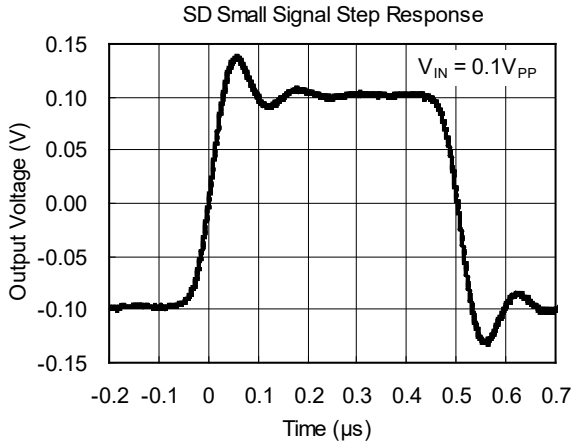

PACKAGE OUTLINE DIMENSIONS

MSOP-10 (Exposed Pad)

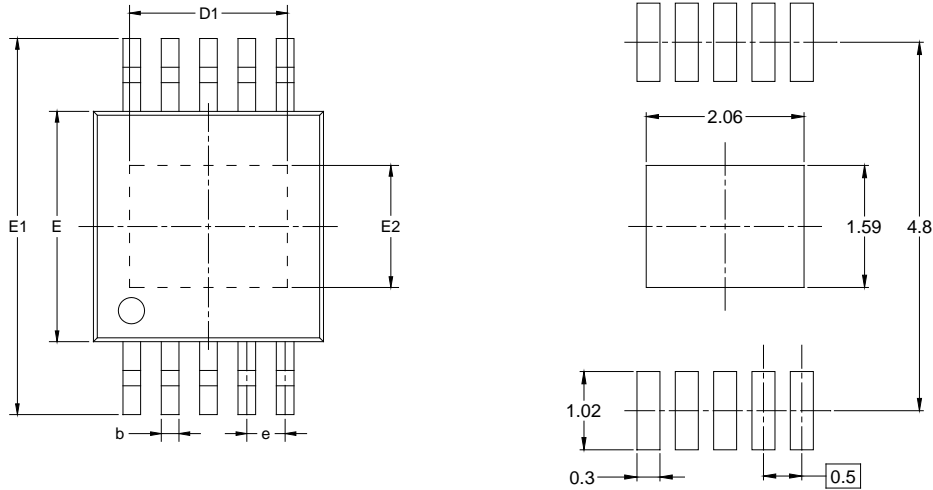

RECOMMENDED LAND PATTERN (Unit: mm)

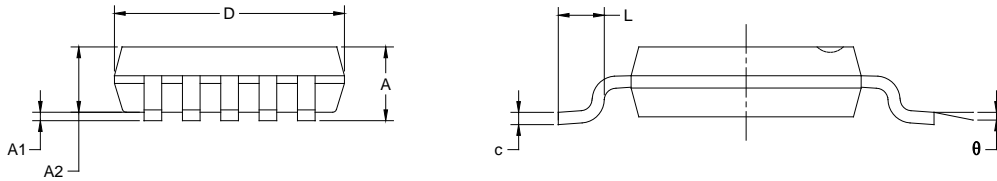

Symbol	Dimensions In Millimeters		
	MIN	MOD	MAX
A	0.820	-	1.100
A1	0.020	-	0.150
A2	0.750	-	0.950
b	0.170	-	0.280
c	0.080	-	0.230
D	2.900	-	3.100
D1	1.700	-	2.416
E	2.900	-	3.100
E1	4.750	-	5.050
E2	1.450	-	1.730
e	0.500 BSC		
L	0.400	-	0.800
θ	0°	-	8°

NOTES:

1. Body dimensions do not include mode flash or protrusion.
2. This drawing is subject to change without notice.

PACKAGE INFORMATION

TAPE AND REEL INFORMATION

REEL DIMENSIONS

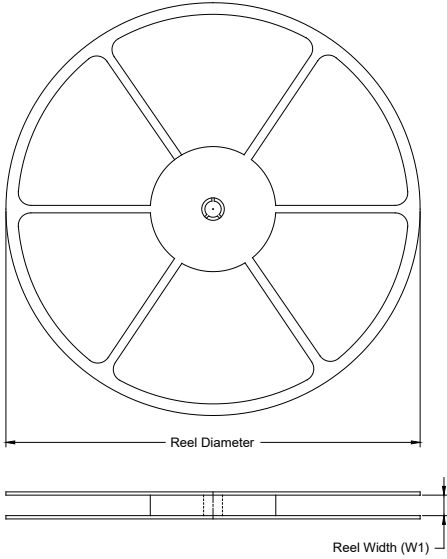

TAPE DIMENSIONS



NOTE: The picture is only for reference. Please make the object as the standard.

KEY PARAMETER LIST OF TAPE AND REEL

Package Type	Reel Diameter	Reel Width W1 (mm)	A0 (mm)	B0 (mm)	K0 (mm)	P0 (mm)	P1 (mm)	P2 (mm)	W (mm)	Pin1 Quadrant
MSOP-10 (Exposed Pad)	13"	12.4	5.20	3.30	1.20	4.0	8.0	2.0	12.0	Q1

000001

PACKAGE INFORMATION

CARTON BOX DIMENSIONS



NOTE: The picture is only for reference. Please make the object as the standard.

KEY PARAMETER LIST OF CARTON BOX

Reel Type	Length (mm)	Width (mm)	Height (mm)	Pizza/Carton
13"	386	280	370	5

DD0002