



SGM8751

64ns, Single-Supply, Low Power, Rail-to-Rail Output Comparator

GENERAL DESCRIPTION

The SGM8751 is a single, high speed, low power comparator, which features a fast 64ns propagation delay. The device is optimized for low voltage operation on 3V or 5V supply, and consumes only 150 μ A supply current.

The SGM8751 supports rail-to-rail output operation. The output voltage swing is within 215mV of the rails without external pull-up or pull-down resistor. The device can be compatible with CMOS and TTL logics. Any input or output pin has a continuous short-circuit protection to both power supply rails.

The SGM8751 is available in a Green SOT-23-5 package. It is rated over the -40°C to +85°C temperature range.

FEATURES

- **High Speed: 64ns Propagation Delay (10mV Overdrive)**
- **Low Supply Current: 150 μ A (TYP) at $V_S = 3V$**
- **Low Offset Voltage: 0.8mV (TYP)**
- **Rail-to-Rail Output**
- **Supply Voltage Range: 2.7V to 5.5V**
- **Optimized for 3V and 5V Applications**
- **Output Swing to within 215mV from Rails with 4mA Output Current**
- **Supports CMOS or TTL Logic**
- **-40°C to +85°C Operating Temperature Range**
- **Available in a Green SOT-23-5 Package**

APPLICATIONS

3V or 5V Applications
Portable/Battery-Powered Equipment
Mobile Phones
Zero-Crossing Detectors
Threshold Detectors
Line Receiver Units

PACKAGE/ORDERING INFORMATION

MODEL	PACKAGE DESCRIPTION	SPECIFIED TEMPERATURE RANGE	ORDERING NUMBER	PACKAGE MARKING	PACKING OPTION
SGM8751	SOT-23-5	-40°C to +85°C	SGM8751YN5G/TR	G07XX	Tape and Reel, 3000

MARKING INFORMATION

NOTE: XX = Date Code.

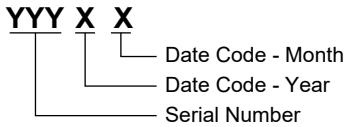

Green (RoHS & HSF): SG Micro Corp defines "Green" to mean Pb-Free (RoHS compatible) and free of halogen substances. If you have additional comments or questions, please contact your SGMICRO representative directly.

ABSOLUTE MAXIMUM RATINGS

Supply Voltage, +Vs to -Vs	6V
Differential Input Voltage, V _{ID} 	V _S
Voltage at Input/Output Pins	(-V _S) - 0.3V to (+V _S) + 0.3V
Junction Temperature	+150°C
Storage Temperature Range	-65°C to +150°C
Lead Temperature (Soldering, 10s)	+260°C
ESD Susceptibility	
HBM	6000V
MM	400V

RECOMMENDED OPERATING CONDITIONS

Supply Voltage Range	2.7V to 5.5V
Operating Temperature Range	-40°C to +85°C

OVERSTRESS CAUTION

Stresses beyond those listed in Absolute Maximum Ratings may cause permanent damage to the device. Exposure to absolute maximum rating conditions for extended periods may affect reliability. Functional operation of the device at any conditions beyond those indicated in the Recommended Operating Conditions section is not implied.

ESD SENSITIVITY CAUTION

This integrated circuit can be damaged if ESD protections are not considered carefully. SGMICRO recommends that all integrated circuits be handled with appropriate precautions.

Failure to observe proper handling and installation procedures can cause damage. ESD damage can range from subtle performance degradation to complete device failure. Precision integrated circuits may be more susceptible to damage because even small parametric changes could cause the device not to meet the published specifications.

DISCLAIMER

SG Micro Corp reserves the right to make any change in circuit design, or specifications without prior notice.

PIN CONFIGURATION

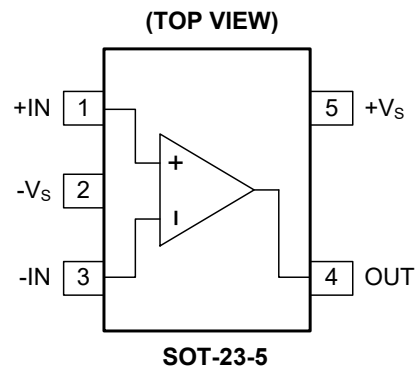

ELECTRICAL CHARACTERISTICS(V_S = 5V, V_{CM} = 0V, C_L = 15pF, typical values are at T_A = +25°C, unless otherwise noted.)

PARAMETER	SYMBOL	CONDITIONS	MIN	TYP	MAX	UNITS
Operating Supply Voltage ⁽¹⁾	V _S		2.7		5.5	V
Input Common Mode Voltage Range ⁽²⁾	V _{CM}		-0.1		V _S - 1.2	V
Input Offset Voltage	V _{OS}	V _S = 5V, V _{CM} = 0V		0.8	5	mV
		-40°C ≤ T _A ≤ +85°C			5.2	
Output Short-Circuit Current	I _{SOURCE}	V _S = 5V, Out to V _S /2	23	32		mA
		-40°C ≤ T _A ≤ +85°C	20			
	I _{SINK}	V _S = 5V, Out to V _S /2		-32	-26	
		-40°C ≤ T _A ≤ +85°C			-22	
Common Mode Rejection Ratio ⁽³⁾	CMRR	V _S = 5V, V _{CM} = 0V to 3.8V	67	81		dB
		-40°C ≤ T _A ≤ +85°C	65			
Power Supply Rejection Ratio	PSRR	V _{CM} = 0V, V _S = 2.7V to 5.5V	67	81		dB
		-40°C ≤ T _A ≤ +85°C	64			
Output Voltage Swing from Rail	V _{OH}	V _S = 5V, I _{OUT} = 4mA		215	340	mV
		-40°C ≤ T _A ≤ +85°C			375	
	V _{OL}	V _S = 5V, I _{OUT} = -4mA		193	265	
		-40°C ≤ T _A ≤ +85°C			295	
Supply Current	I _S	V _S = 3V, I _{OUT} = 0		150	210	μA
		-40°C ≤ T _A ≤ +85°C			235	
		V _S = 5V, I _{OUT} = 0		155	220	
		-40°C ≤ T _A ≤ +85°C			245	
Propagation Delay (High to Low)		V _S = 3V, Overdrive = 10mV, V _{CM} = 0V		64		ns
		V _S = 3V, Overdrive = 100mV, V _{CM} = 0V		30		
Propagation Delay (Low to High)		V _S = 3V, Overdrive = 10mV, V _{CM} = 0V		48		ns
		V _S = 3V, Overdrive = 100mV, V _{CM} = 0V		22		
Rise Time	t _{RISE}	V _S = 3V, Overdrive = 10mV, V _{CM} = 0V		12		ns
		V _S = 3V, Overdrive = 100mV, V _{CM} = 0V		11		
Fall Time	t _{FALL}	V _S = 3V, Overdrive = 10mV, V _{CM} = 0V		11		ns
		V _S = 3V, Overdrive = 100mV, V _{CM} = 0V		8		

NOTES:

1. This value is from PSRR test.
2. This value is from PD test. For the range of common mode voltage, the maximum input common mode voltage can reach V_{CC} + 0.1V without any damage to SGM8751.
3. CMRR is defined over the condition of whole input common mode range.

TYPICAL PERFORMANCE CHARACTERISTICS

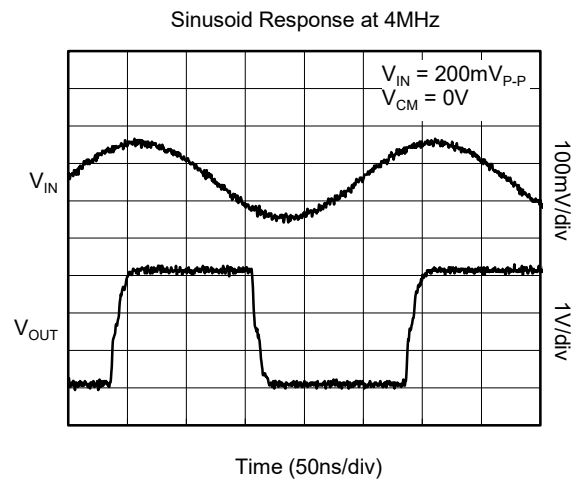
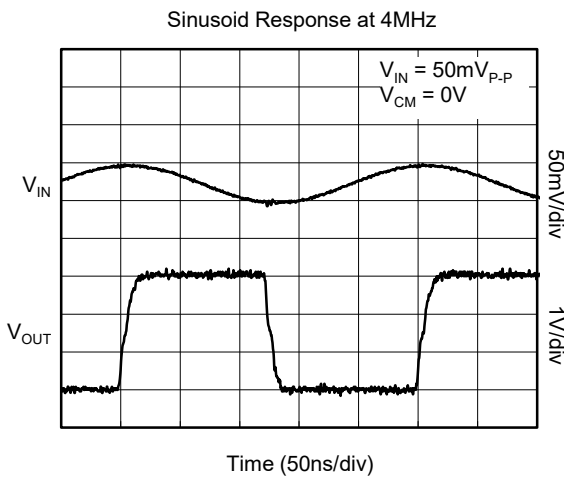
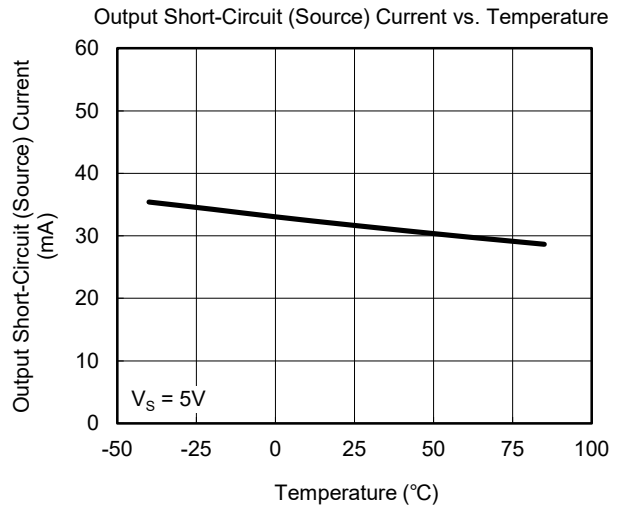
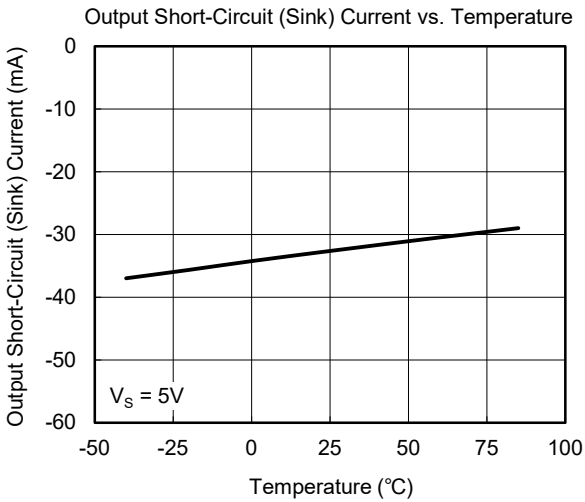
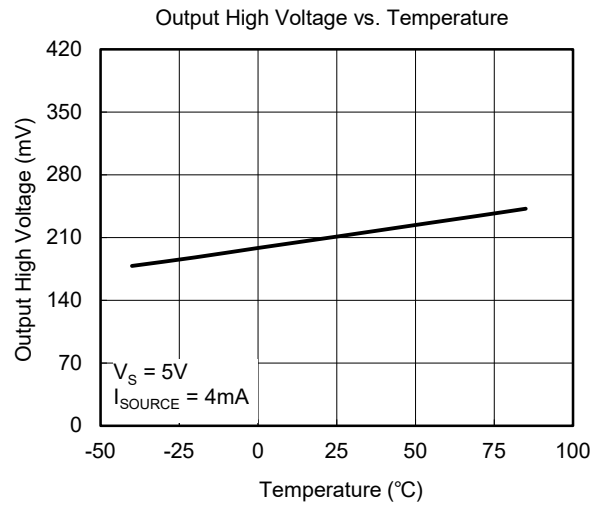
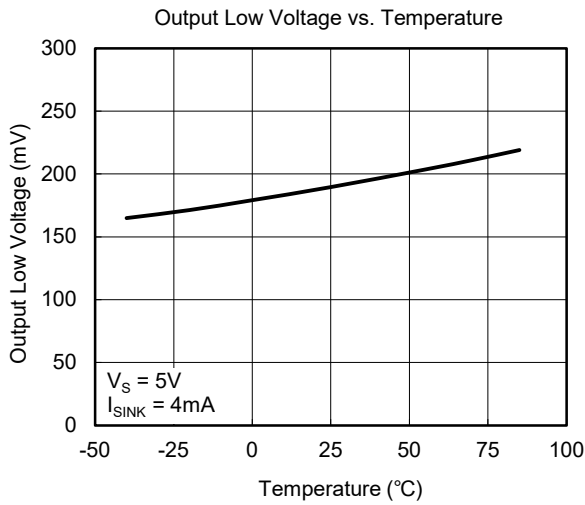

TYPICAL PERFORMANCE CHARACTERISTICS (continued)

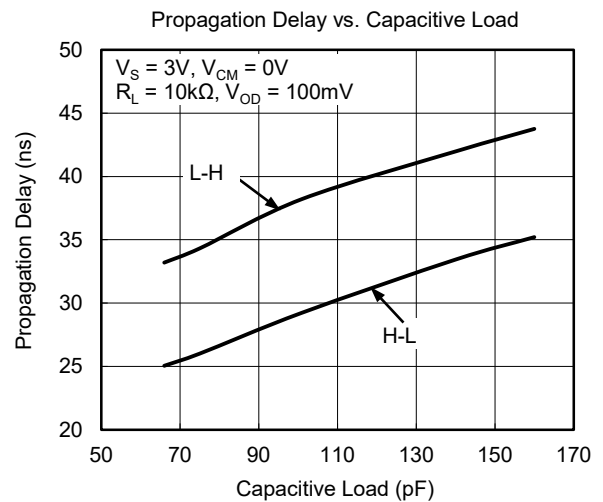
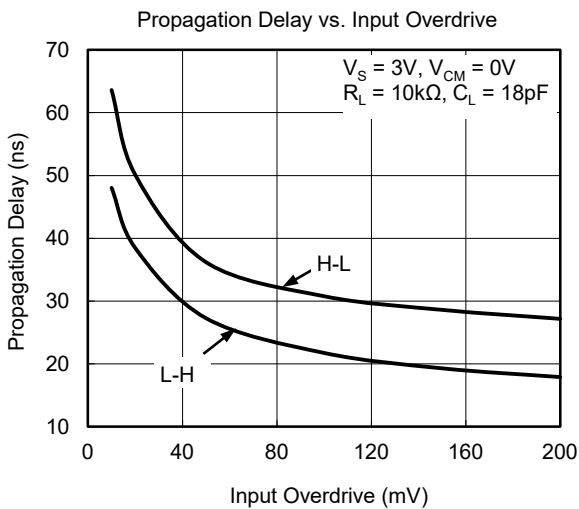
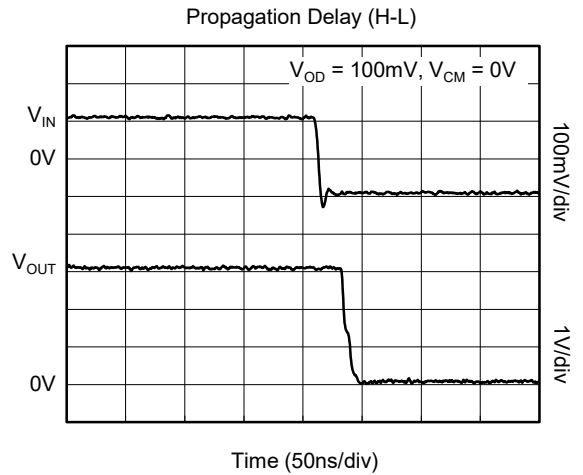
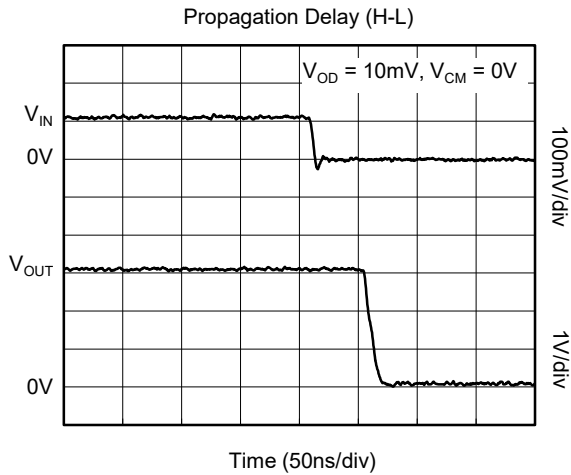
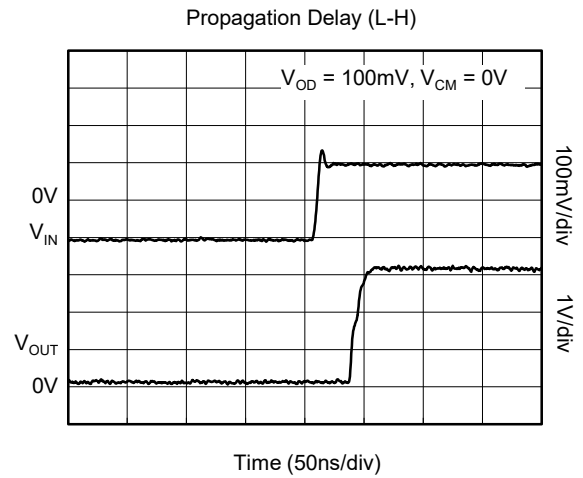
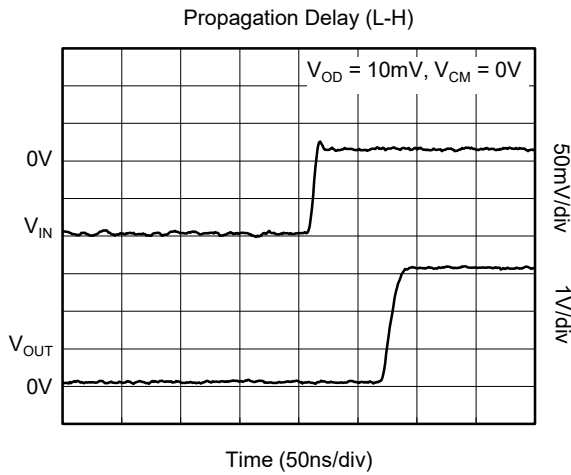

TYPICAL PERFORMANCE CHARACTERISTICS (continued)

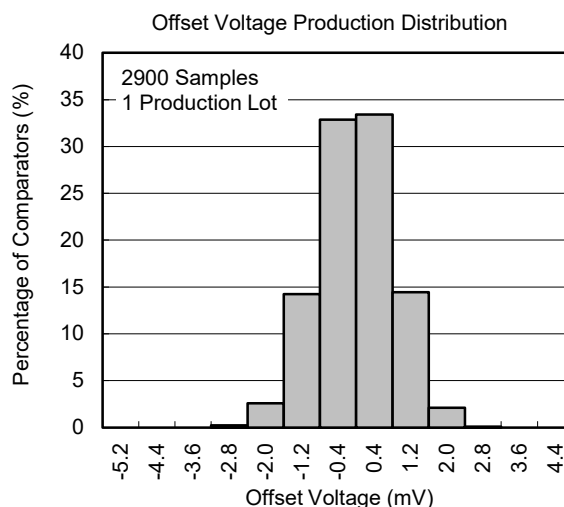
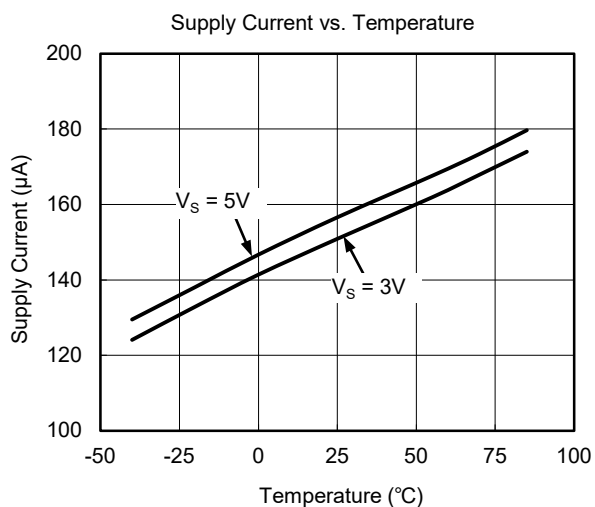

DETAILED DESCRIPTION

The SGM8751 is a single, high speed, low power comparator with internal hysteresis. The device is optimized for low voltage operation from 2.7V to 5.5V single supply. It supports rail-to-rail output operation. With 4mA output current, the output voltage swing is within 215mV of the rails without external pull-up or pull-down circuitry. The SGM8751 is suitable for portable equipment. It can be compatible with CMOS and TTL logics.

Output Structure

In Figure 1, the SGM8751 has a push-pull output stage. When output is changed from logic high/low to low/high, the changed sink/source current pulls/pushes output pin to logic low/high. Beginning this transition, larger sink/source current is used to create a high slew rate transit from high/low to low/high. Once the output voltage reaches V_{OL}/V_{OH} , it will reduce the sink/source current to a just right value to maintain the V_{OL}/V_{OH} static condition. This current-driven push-pull output stage will significantly reduce the power consumption in application system.

If low slew rate transition is needed in system design, adjusting the load capacitance will change the slew rate. The heavier capacitive load will slow down the output voltage transition. This feature will be used to reduce the interference generated by fast edge of transition between 1 and 0 in noise-sensitive system.

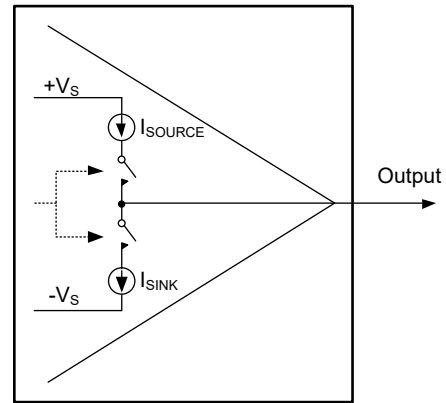

Figure 1. Push-Pull Output Structure

APPLICATION INFORMATION

Application Circuits

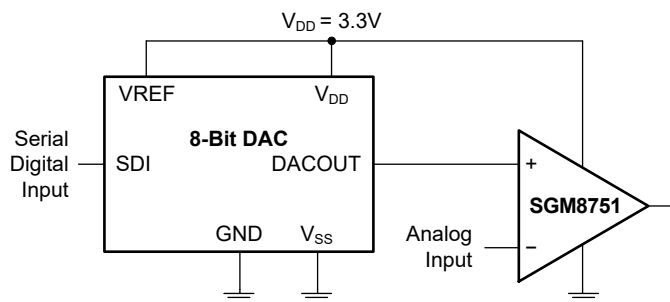

Figure 2. A Threshold Detector Controlled by 8-Bit DAC

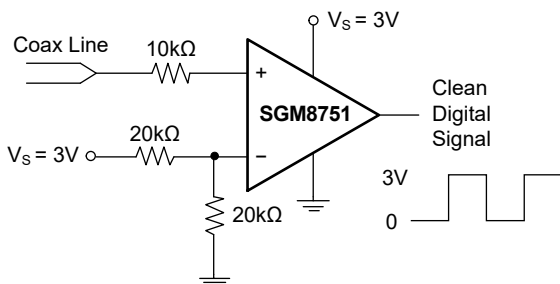

Figure 3. The Application of Line Receiver

Layout and Bypassing

Good power supply decoupling, layout and grounding are very important for SGM8751 to realize the full high-speed capabilities in system, following skills will be used:

- ◆ A 0.1μF to 4.7μF range ceramic capacitor is used to provide good power supply decoupling. This ceramic capacitor must be placed as close to +Vs pin as possible.
- ◆ For grounding, unbroken and low-inductance ground plane is a good choice.
- ◆ For Layout, use short PCB trace to avoid unwanted parasitic feedback around the comparator. SGM8751 must be soldered directly to the PCB and the socket is not recommended.

REVISION HISTORY

NOTE: Page numbers for previous revisions may differ from page numbers in the current version.

AUGUST 2022 – REV.A to REV.A.1	Page
Updated Absolute Maximum Ratings section.....	2

Changes from Original (FEBRUARY 2015) to REV.A	Page
Changed from product preview to production data.....	All

PACKAGE OUTLINE DIMENSIONS

SOT-23-5

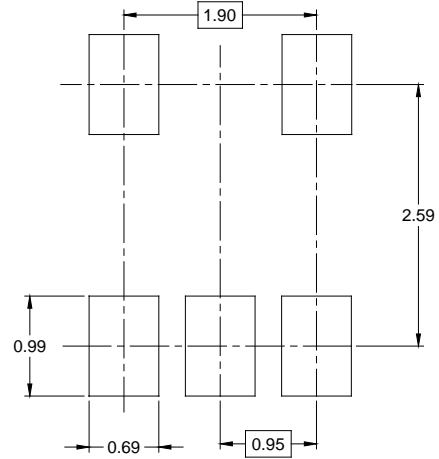
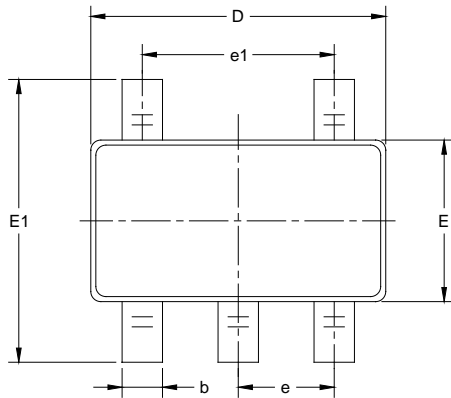

RECOMMENDED LAND PATTERN (Unit: mm)

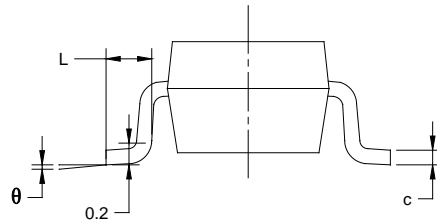
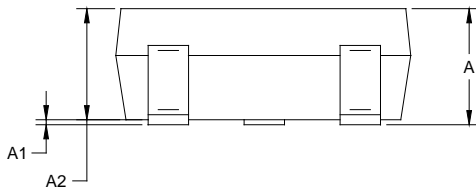

Symbol	Dimensions In Millimeters		Dimensions In Inches	
	MIN	MAX	MIN	MAX
A	1.050	1.250	0.041	0.049
A1	0.000	0.100	0.000	0.004
A2	1.050	1.150	0.041	0.045
b	0.300	0.500	0.012	0.020
c	0.100	0.200	0.004	0.008
D	2.820	3.020	0.111	0.119
E	1.500	1.700	0.059	0.067
E1	2.650	2.950	0.104	0.116
e	0.950 BSC		0.037 BSC	
e1	1.900 BSC		0.075 BSC	
L	0.300	0.600	0.012	0.024
θ	0°	8°	0°	8°

NOTES:

1. Body dimensions do not include mode flash or protrusion.
2. This drawing is subject to change without notice.

PACKAGE INFORMATION

TAPE AND REEL INFORMATION

REEL DIMENSIONS



TAPE DIMENSIONS



NOTE: The picture is only for reference. Please make the object as the standard.

KEY PARAMETER LIST OF TAPE AND REEL

Package Type	Reel Diameter	Reel Width W1 (mm)	A0 (mm)	B0 (mm)	K0 (mm)	P0 (mm)	P1 (mm)	P2 (mm)	W (mm)	Pin1 Quadrant
SOT-23-5	7"	9.5	3.20	3.20	1.40	4.0	4.0	2.0	8.0	Q3

DD0001

PACKAGE INFORMATION

CARTON BOX DIMENSIONS



NOTE: The picture is only for reference. Please make the object as the standard.

KEY PARAMETER LIST OF CARTON BOX

Reel Type	Length (mm)	Width (mm)	Height (mm)	Pizza/Carton
7" (Option)	368	227	224	8
7"	442	410	224	18

DD0002