

### GENERAL DESCRIPTION

The SGM2209 is a low power, low noise, fast transient response and low dropout voltage linear regulator. It provides -500mA output current capability. The operating input voltage range is from -2.7V to -24V. The adjustable output voltage range is from -1.2V to  $(-V_{IN} + V_{DROP})$ .

Other features include logic-controlled shutdown mode, short-circuit current limit and thermal shutdown protection. The SGM2209 has automatic discharge function to quickly discharge  $V_{OUT}$  in the disabled status.

The SGM2209 is available in Green TDFN-2x2-6AL, TDFN-3x3-8L and SOT-23-5 packages. It operates over an operating temperature range of -40°C to +125°C.

### APPLICATIONS

Industrial and Medical Equipment  
 Communications and Infrastructure  
 Precision Amplifiers  
 ADC and DAC Circuits

### FEATURES

- **Input Voltage Range: -2.7V to -24V**
- **Fixed Outputs of -1.2V, -1.5V, -1.8V, -2.5V, -2.8V, -3.0V, -3.3V and -5.0V**
- **Adjustable Output from -1.2V to  $(-V_{IN} + V_{DROP})$**
- **-500mA Output Current**
- **Output Voltage Accuracy:  $\pm 1\%$  at +25°C**
- **Low Quiescent Current:**  
 $I_{GND} = -1.2mA$  (TYP) with -500mA Load
- **Low Dropout Voltage:**  
 $-345mV$  (TYP) at -500mA, at  $V_{OUT} = -3.0V$
- **Low Noise:**
  - ◆  $10.5\mu V_{RMS}$  (TYP) at  $V_{OUT} = -1.2V$
  - ◆  $12\mu V_{RMS}$  (TYP) at  $V_{OUT} = -2.5V$
  - ◆  $16\mu V_{RMS}$  (TYP) at  $V_{OUT} = -5.0V$
- **PSRR: -60dB at 10kHz at  $V_{OUT} = -2.5V$**
- **Positive or Negative Enable Logic**
- **Current Limiting and Thermal Protection**
- **With Output Automatic Discharge**
- **Stable with Small Case Size Ceramic Capacitors**
- **Low Shutdown Supply Current:  $-1.1\mu A$  (TYP)**
- **-40°C to +125°C Operating Temperature Range**
- **Available in Green TDFN-2x2-6AL, TDFN-3x3-8L and SOT-23-5 Packages**

### TYPICAL APPLICATION

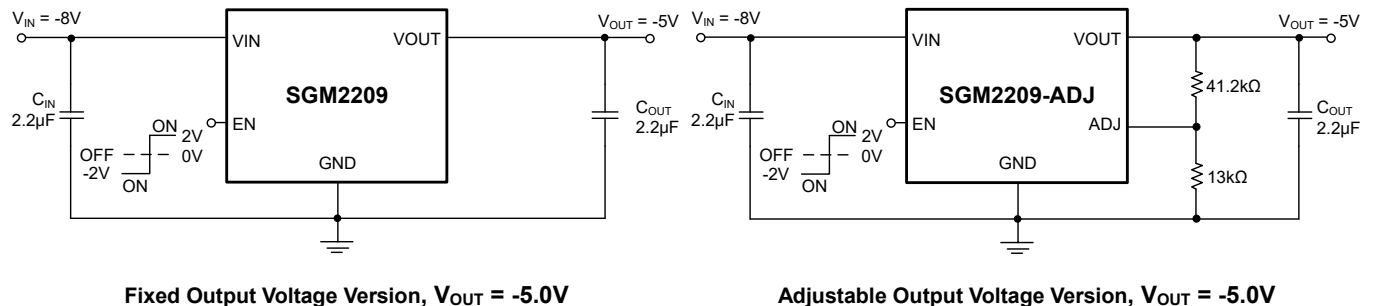

Figure 1. Typical Application Circuits

**PACKAGE/ORDERING INFORMATION**

MODEL	PACKAGE DESCRIPTION	SPECIFIED TEMPERATURE RANGE	ORDERING NUMBER	PACKAGE MARKING	PACKING OPTION
SGM2209-1.2	TDFN-2×2-6AL	-40°C to +125°C	SGM2209-1.2XTDI6G/TR	MY2 XXXX	Tape and Reel, 3000
SGM2209-1.5	TDFN-2×2-6AL	-40°C to +125°C	SGM2209-1.5XTDI6G/TR	MY3 XXXX	Tape and Reel, 3000
SGM2209-1.8	TDFN-2×2-6AL	-40°C to +125°C	SGM2209-1.8XTDI6G/TR	CA3 XXXX	Tape and Reel, 3000
SGM2209-2.5	TDFN-2×2-6AL	-40°C to +125°C	SGM2209-2.5XTDI6G/TR	MY4 XXXX	Tape and Reel, 3000
SGM2209-2.8	TDFN-2×2-6AL	-40°C to +125°C	SGM2209-2.8XTDI6G/TR	CA4 XXXX	Tape and Reel, 3000
SGM2209-3.0	TDFN-2×2-6AL	-40°C to +125°C	SGM2209-3.0XTDI6G/TR	CA5 XXXX	Tape and Reel, 3000
SGM2209-3.3	TDFN-2×2-6AL	-40°C to +125°C	SGM2209-3.3XTDI6G/TR	CA6 XXXX	Tape and Reel, 3000
SGM2209-5.0	TDFN-2×2-6AL	-40°C to +125°C	SGM2209-5.0XTDI6G/TR	MY5 XXXX	Tape and Reel, 3000
SGM2209-ADJ	TDFN-2×2-6AL	-40°C to +125°C	SGM2209-ADJXTDI6G/TR	MY6 XXXX	Tape and Reel, 3000
SGM2209-1.2	TDFN-3×3-8L	-40°C to +125°C	SGM2209-1.2XTDB8G/TR	SGM C9CDB XXXXX	Tape and Reel, 4000
SGM2209-1.5	TDFN-3×3-8L	-40°C to +125°C	SGM2209-1.5XTDB8G/TR	SGM C9DDB XXXXX	Tape and Reel, 4000
SGM2209-1.8	TDFN-3×3-8L	-40°C to +125°C	SGM2209-1.8XTDB8G/TR	SGM C9EDB XXXXX	Tape and Reel, 4000
SGM2209-2.5	TDFN-3×3-8L	-40°C to +125°C	SGM2209-2.5XTDB8G/TR	SGM C9FDB XXXXX	Tape and Reel, 4000
SGM2209-2.8	TDFN-3×3-8L	-40°C to +125°C	SGM2209-2.8XTDB8G/TR	SGM CA0DB XXXXX	Tape and Reel, 4000
SGM2209-3.0	TDFN-3×3-8L	-40°C to +125°C	SGM2209-3.0XTDB8G/TR	SGM CA1DB XXXXX	Tape and Reel, 4000
SGM2209-3.3	TDFN-3×3-8L	-40°C to +125°C	SGM2209-3.3XTDB8G/TR	SGM CA2DB XXXXX	Tape and Reel, 4000
SGM2209-5.0	TDFN-3×3-8L	-40°C to +125°C	SGM2209-5.0XTDB8G/TR	SGM MY0DB XXXXX	Tape and Reel, 4000
SGM2209-ADJ	TDFN-3×3-8L	-40°C to +125°C	SGM2209-ADJXTDB8G/TR	SGM MY1DB XXXXX	Tape and Reel, 4000

**PACKAGE/ORDERING INFORMATION (continued)**

MODEL	PACKAGE DESCRIPTION	SPECIFIED TEMPERATURE RANGE	ORDERING NUMBER	PACKAGE MARKING	PACKING OPTION
SGM2209-1.2	SOT-23-5	-40°C to +125°C	SGM2209-1.2XN5G/TR	C9AXX	Tape and Reel, 3000
SGM2209-1.5	SOT-23-5	-40°C to +125°C	SGM2209-1.5XN5G/TR	C9BXX	Tape and Reel, 3000
SGM2209-1.8	SOT-23-5	-40°C to +125°C	SGM2209-1.8XN5G/TR	MX9XX	Tape and Reel, 3000
SGM2209-2.5	SOT-23-5	-40°C to +125°C	SGM2209-2.5XN5G/TR	MXAXX	Tape and Reel, 3000
SGM2209-2.8	SOT-23-5	-40°C to +125°C	SGM2209-2.8XN5G/TR	MXBXX	Tape and Reel, 3000
SGM2209-3.0	SOT-23-5	-40°C to +125°C	SGM2209-3.0XN5G/TR	MXCXX	Tape and Reel, 3000
SGM2209-3.3	SOT-23-5	-40°C to +125°C	SGM2209-3.3XN5G/TR	MXDXX	Tape and Reel, 3000
SGM2209-5.0	SOT-23-5	-40°C to +125°C	SGM2209-5.0XN5G/TR	MXEXX	Tape and Reel, 3000
SGM2209-ADJ	SOT-23-5	-40°C to +125°C	SGM2209-ADJXN5G/TR	MXFXX	Tape and Reel, 3000

**MARKING INFORMATION**

**TDFN-2x2-6AL**

1. XXXX = Date Code and Trace Code.

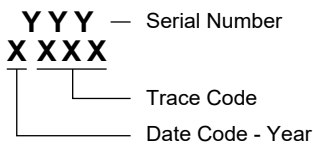

**TDFN-3x3-8L**

2. XXXXX = Date Code, Trace Code and Vendor Code.

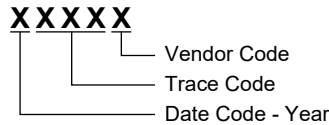

**SOT-23-5**

3. XX = Date Code.

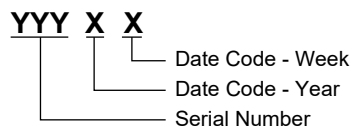

Green (RoHS & HSF): SG Micro Corp defines "Green" to mean Pb-Free (RoHS compatible) and free of halogen substances. If you have additional comments or questions, please contact your SGMICRO representative directly.

**ABSOLUTE MAXIMUM RATINGS**

VIN to GND.....	+0.3V to -25V
VOUT to GND.....	+0.3V to VIN - 0.3V
EN to GND.....	+5V to VIN - 0.3V
EN to VIN.....	+25V to -0.3V
ADJ to GND.....	+0.3V to VOUT
Package Thermal Resistance	
TDFN-2x2-6AL, $\theta_{JA}$ .....	101°C/W
TDFN-2x2-6AL, $\theta_{JB}$ .....	39°C/W
TDFN-2x2-6AL, $\theta_{JC}$ .....	83°C/W
TDFN-3x3-8L, $\theta_{JA}$ .....	70°C/W
TDFN-3x3-8L, $\theta_{JB}$ .....	25°C/W
TDFN-3x3-8L, $\theta_{JC}$ .....	47°C/W
SOT-23-5, $\theta_{JA}$ .....	186°C/W
SOT-23-5, $\theta_{JB}$ .....	45°C/W
SOT-23-5, $\theta_{JC}$ .....	74°C/W
Junction Temperature.....	+150°C
Storage Temperature Range.....	-65°C to +150°C
Lead Temperature (Soldering, 10s).....	+260°C
ESD Susceptibility	
HBM.....	8000V
CDM.....	1000V

**RECOMMENDED OPERATING CONDITIONS**

Input Voltage Range.....	-2.7V to -24V
Operating Junction Temperature Range.....	-40°C to +125°C
Input Capacitance, CIN.....	1.5µF (MIN)
Output Capacitance, COUT.....	1.5µF to 10µF

**OVERSTRESS CAUTION**

Stresses beyond those listed in Absolute Maximum Ratings may cause permanent damage to the device. Exposure to absolute maximum rating conditions for extended periods may affect reliability. Functional operation of the device at any conditions beyond those indicated in the Recommended Operating Conditions section is not implied.

**ESD SENSITIVITY CAUTION**

This integrated circuit can be damaged if ESD protections are not considered carefully. SGMICRO recommends that all integrated circuits be handled with appropriate precautions. Failure to observe proper handling and installation procedures can cause damage. ESD damage can range from subtle performance degradation to complete device failure. Precision integrated circuits may be more susceptible to damage because even small parametric changes could cause the device not to meet the published specifications.

**DISCLAIMER**

SG Micro Corp reserves the right to make any change in circuit design, or specifications without prior notice.

**PIN CONFIGURATIONS**

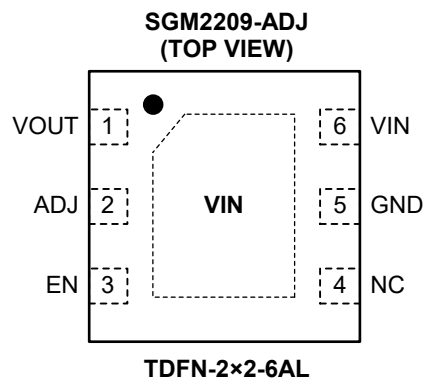
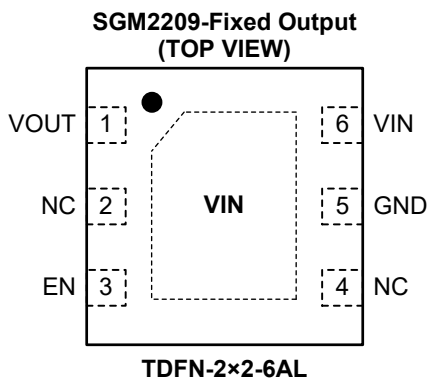

PIN CONFIGURATIONS (continued)

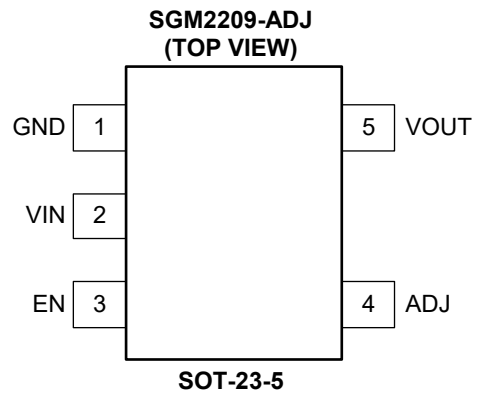
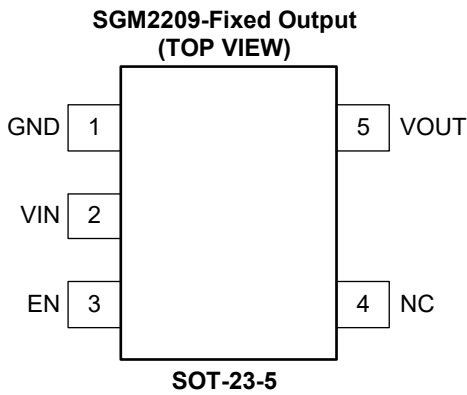
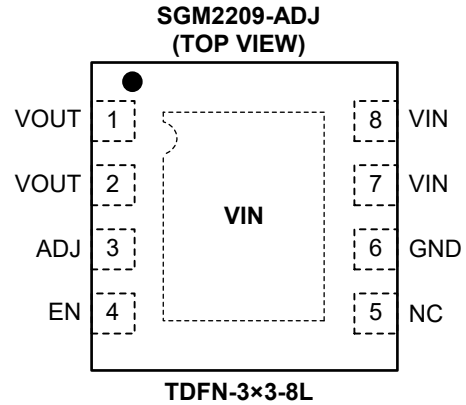
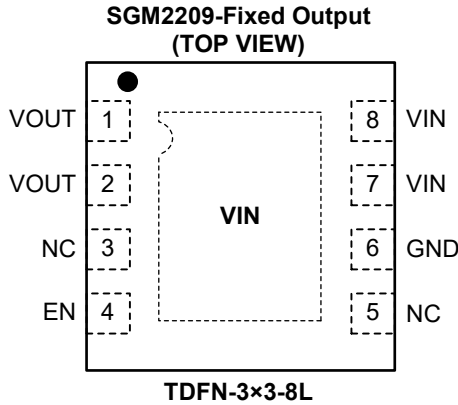

PIN DESCRIPTION

PIN			NAME	FUNCTION
TDFN-2x2-6AL	TDFN-3x3-8L	SOT-23-5		
1	1, 2	5	VOUT	Regulator Output Pin. It is recommended to use a ceramic capacitor with effective capacitance in the range of 1.5µF to 10µF to ensure stability. This ceramic capacitor should be placed as close as possible to VOUT pin.
2	3	4	NC	Not Connected (fixed voltage version).
			ADJ	Adjustable Input (adjustable voltage version only). Connect this pin to the midpoint of an external resistor divider to adjust the output voltage. Place the resistors as close as possible to this pin.
3	4	3	EN	Enable Pin. Drive EN 2.0V above or below ground to turn on the regulator. Drive EN to ground to turn off the regulator. Connect the EN pin to the VIN pin when using automatic startup.
4	5	–	NC	Not Connected.
5	6	1	GND	Ground.
6	7, 8	2	VIN	Input Voltage Supply Pin. It is recommended to use a 2.2µF or larger ceramic capacitor from VIN pin to ground to get good power supply decoupling. This ceramic capacitor should be placed as close as possible to VIN pin.
Exposed Pad	Exposed Pad	–	VIN	Exposed Pad. Connect the exposed pad at the bottom of the package to the internal VIN for maximum thermal performance. In normal use, connect the exposed pad to the VIN on the board, which is the most negative potential in the negative voltage regulating circuit.

**ELECTRICAL CHARACTERISTICS**

( $V_{IN} = (V_{OUT(NOM)} - 0.5V)$  or  $-2.7V$  (whichever is greater),  $V_{EN} = V_{IN}$ ,  $I_{OUT} = -10mA$ ,  $C_{IN} = C_{OUT} = 2.2\mu F$ ,  $T_J = -40^\circ C$  to  $+125^\circ C$ , typical values are at  $T_J = +25^\circ C$ , unless otherwise noted.)

PARAMETER	SYMBOL	CONDITIONS	TEMP	MIN	TYP	MAX	UNITS	
Input Voltage Range	$V_{IN}$	$I_{OUT} = -250mA$	$+25^\circ C$	-2.7		-24	V	
		$I_{OUT} = -350mA$	$+25^\circ C$	-3.0		-24	V	
		$I_{OUT} = -500mA$	$+25^\circ C$	-3.3		-24	V	
Output Voltage Accuracy	$V_{OUT}$	$I_{OUT} = -10mA$	$+25^\circ C$	-1		1	%	
		$V_{IN} = (V_{OUT(NOM)} - 0.5V)$ to $-24V$ , $I_{OUT} = -1mA$ to $-500mA$	$-40^\circ C$ to $+125^\circ C$	-1.5		1.5	%	
Feedback Voltage	$V_{ADJ}$	$I_{OUT} = -10mA$	$+25^\circ C$	-1.188	-1.2	-1.212	V	
		$V_{IN} = (V_{OUT(NOM)} - 0.5V)$ to $-24V$ , $I_{OUT} = -1mA$ to $-500mA$	$-40^\circ C$ to $+125^\circ C$	-1.182		-1.218	V	
ADJ Pin Input Bias Current	$I_{ADJ}$	$V_{ADJ} = -1.3V$ , $V_{IN} = -2.7V$ to $-24V$	$-40^\circ C$ to $+125^\circ C$	-3.5		3.5	nA	
Under-Voltage Lockout Thresholds	$V_{UVLO}$	$V_{IN}$ falling	$-40^\circ C$ to $+125^\circ C$		-2.42	-2.50	V	
		$V_{IN}$ rising	$-40^\circ C$ to $+125^\circ C$	-2.24	-2.33		V	
Line Regulation	$\frac{\Delta V_{OUT}}{\Delta V_{IN} \times V_{OUT}}$	$V_{IN} = (V_{OUT(NOM)} - 0.5V)$ to $-24V$	$-40^\circ C$ to $+125^\circ C$		0.001	0.03	%/V	
Load Regulation	$\frac{\Delta V_{OUT}}{V_{OUT}}$	$I_{OUT} = -1mA$ to $-500mA$	$-40^\circ C$ to $+125^\circ C$		0.03	0.8	%	
Dropout Voltage <sup>(1)</sup>	$V_{DROP}$	$I_{OUT} = -250mA$	$V_{OUT(NOM)} = -2.5V$	$-40^\circ C$ to $+125^\circ C$		-230	-350	mV
			$V_{OUT(NOM)} = -3.0V$	$-40^\circ C$ to $+125^\circ C$		-160	-260	
			$V_{OUT(NOM)} = -5.0V$	$-40^\circ C$ to $+125^\circ C$		-125	-220	
		$I_{OUT} = -350mA$	$V_{OUT(NOM)} = -3.0V$	$-40^\circ C$ to $+125^\circ C$		-230	-370	
			$V_{OUT(NOM)} = -5.0V$	$-40^\circ C$ to $+125^\circ C$		-180	-300	
			$I_{OUT} = -500mA$	$V_{OUT(NOM)} = -3.0V$	$-40^\circ C$ to $+125^\circ C$		-345	
$V_{OUT(NOM)} = -5.0V$	$-40^\circ C$ to $+125^\circ C$			-260	-420			
Output Current Limit <sup>(2)</sup>	$I_{LIMIT}$	$V_{IN} = \text{MIN}(V_{OUT(NOM)} - 1V, -4V)$	$+25^\circ C$	-0.68	-1.05		A	
Short-Circuit Current	$I_{SHORT}$	$V_{OUT} = 0V$ , $V_{IN} = \text{MIN}(V_{OUT(NOM)} - 1V, -4V)$	$+25^\circ C$		-360		mA	
Operating Supply Current	$I_{GND}$	$I_{OUT} = 0\mu A$	$-40^\circ C$ to $+125^\circ C$		-42	-83	$\mu A$	
		$I_{OUT} = -500mA$	$-40^\circ C$ to $+125^\circ C$		-1.2	-2.1	mA	
Shutdown Current	$I_{SHDN}$	$V_{EN} = GND$	$-40^\circ C$ to $+125^\circ C$		-1.1	-3.0	$\mu A$	
		$V_{EN} = GND$ , $V_{IN} = -24V$	$-40^\circ C$ to $+125^\circ C$		-1.2	-10		
Positive Enable High-Level Voltage	$V_{EN(+HI)}$		$-40^\circ C$ to $+125^\circ C$	1.22			V	
Positive Enable Low-Level Voltage	$V_{EN(+LO)}$		$-40^\circ C$ to $+125^\circ C$			0.3		
Negative Enable High-Level Voltage	$V_{EN(-HI)}$		$-40^\circ C$ to $+125^\circ C$			-2.0	V	
Negative Enable Low-Level Voltage	$V_{EN(-LO)}$		$-40^\circ C$ to $+125^\circ C$	-0.55				
EN Positive Input Current	$I_{EN\_P}$	$V_{EN} = 5V$ , $V_{IN} = -19V$	$-40^\circ C$ to $+125^\circ C$		0.9	3	$\mu A$	
EN Negative Input Current	$I_{EN\_N}$	$V_{EN} = -24V$ , $V_{IN} = -24V$	$-40^\circ C$ to $+125^\circ C$		-0.1	-1	$\mu A$	
Start-Up Time <sup>(3)</sup>	$t_{STR}$	$V_{OUT(NOM)} = -1.2V$	$+25^\circ C$		210		$\mu s$	
		$V_{OUT(NOM)} = -5.0V$	$+25^\circ C$		540			

NOTES:

1. The dropout voltage is defined as the difference between  $V_{IN}$  and  $V_{OUT}$  when  $V_{OUT}$  falls to  $95\% \times V_{OUT(NOM)}$ .
2. Output current limit has the function of current foldback protection and refers to the current at which  $V_{OUT}$  falls to  $90\% \times V_{OUT(NOM)}$ .
3. The start-up time is defined as the time between the EN rising edge to  $V_{OUT}$  reaching  $90\% \times V_{OUT(NOM)}$ .

**ELECTRICAL CHARACTERISTICS (continued)**

( $V_{IN} = (V_{OUT(NOM)} - 0.5V)$  or  $-2.7V$ , whichever is greater,  $V_{EN} = V_{IN}$ ,  $I_{OUT} = -10mA$ ,  $C_{IN} = C_{OUT} = 2.2\mu F$ ,  $T_J = -40^{\circ}C$  to  $+125^{\circ}C$ , typical values are at  $T_J = +25^{\circ}C$ , unless otherwise noted.)

PARAMETER	SYMBOL	CONDITIONS	TEMP	MIN	TYP	MAX	UNITS
Power Supply Rejection Ratio	PSRR	$V_{IN} = V_{OUT(NOM)} - 1V$ , $\Delta V_{RIPPLE} = 0.2V_{P-P}$ , all fixed output voltage options	f = 1kHz	+25°C		-75	dB
			f = 10kHz	+25°C		-60	
			f = 100kHz	+25°C		-42	
Output Voltage Noise	$e_n$	10Hz to 100kHz	$V_{OUT(NOM)} = -1.2V$	+25°C		10.5	$\mu V_{RMS}$
			$V_{OUT(NOM)} = -2.5V$	+25°C		12	
			$V_{OUT(NOM)} = -5.0V$	+25°C		16	
		10Hz to 100kHz, $V_{OUT(NOM)} = -15V$ , adjustable mode, $R_{FB1} = 150k\Omega$ , $R_{FB2} = 13k\Omega$	+25°C		130		
Thermal Shutdown Temperature	$T_{SHDN}$				160		°C
Thermal Shutdown Hysteresis	$\Delta T_{SHDN}$				20		°C

**TYPICAL PERFORMANCE CHARACTERISTICS**

$V_{IN} = (V_{OUT(NOM)} - 0.5V)$  or  $-2.7V$ , whichever is greater,  $V_{EN} = V_{IN}$ ,  $I_{OUT} = -10mA$ ,  $C_{IN} = C_{OUT} = 2.2\mu F$ ,  $T_J = +25^\circ C$ , unless otherwise noted.

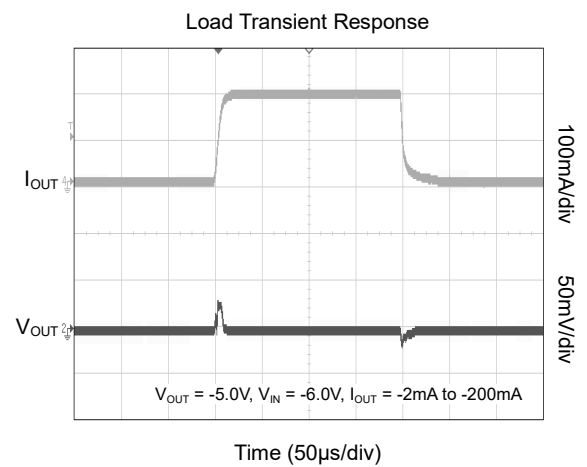
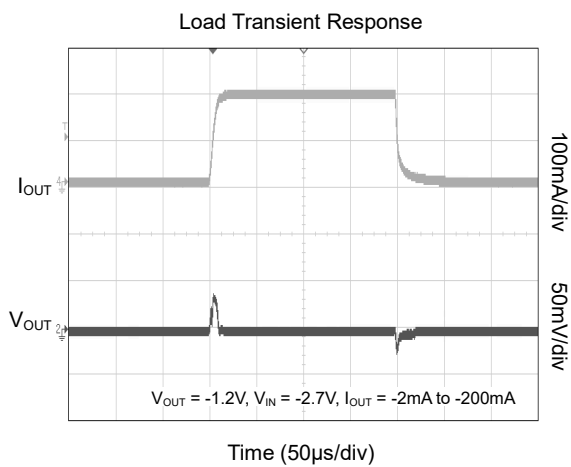
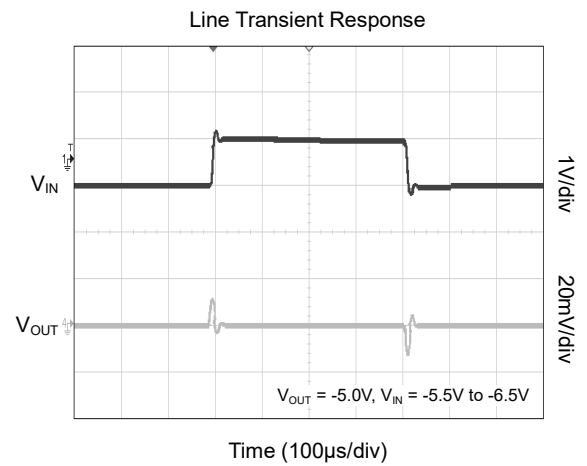
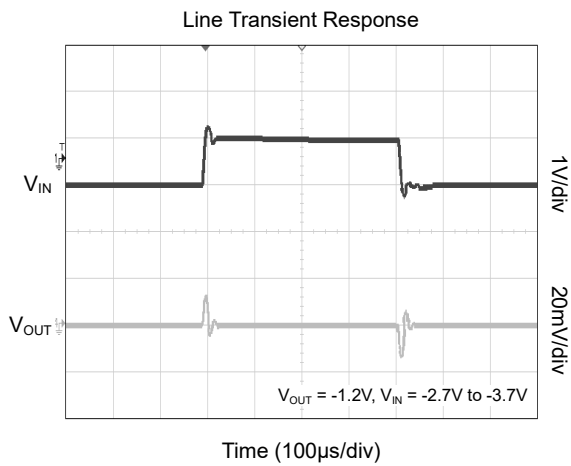
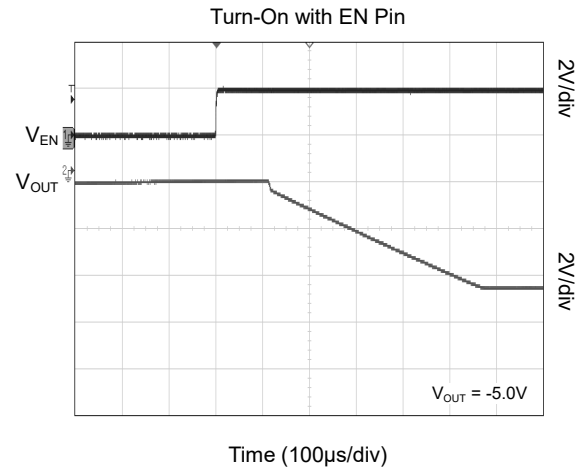
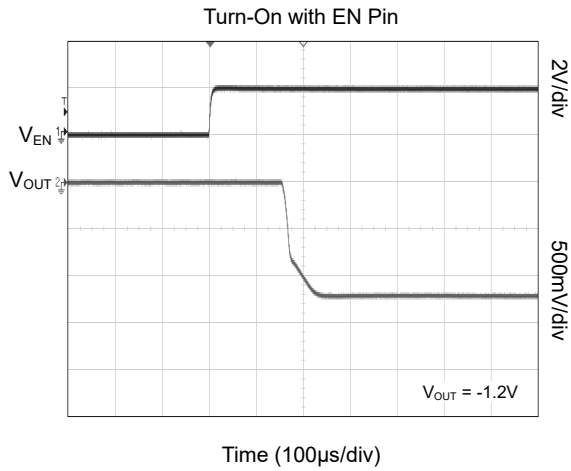



TYPICAL PERFORMANCE CHARACTERISTICS (continued)

$V_{IN} = (V_{OUT(NOM)} - 0.5V)$  or  $-2.7V$ , whichever is greater,  $V_{EN} = V_{IN}$ ,  $I_{OUT} = -10mA$ ,  $C_{IN} = C_{OUT} = 2.2\mu F$ ,  $T_J = +25^\circ C$ , unless otherwise noted.

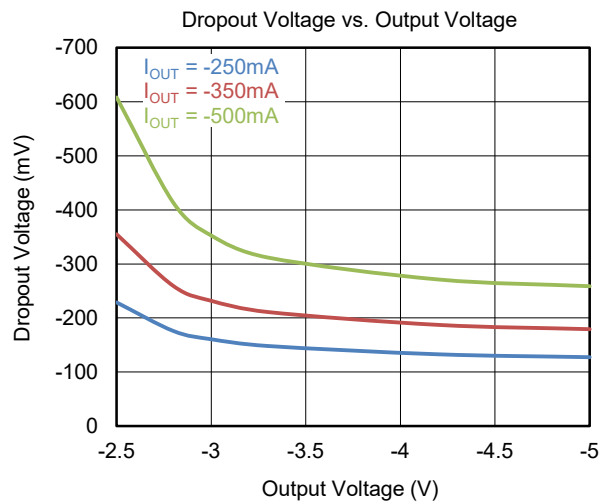
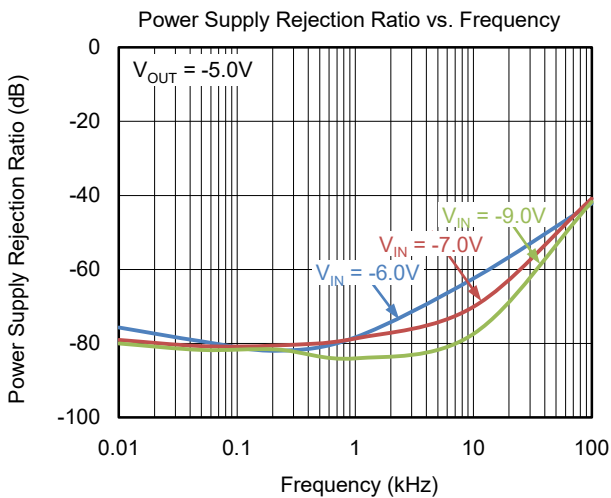
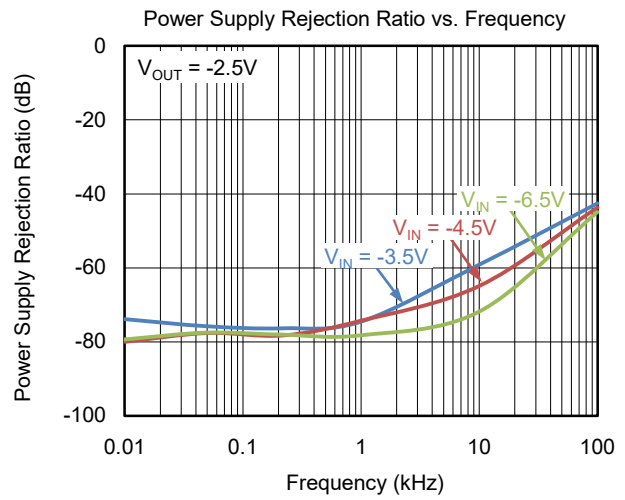
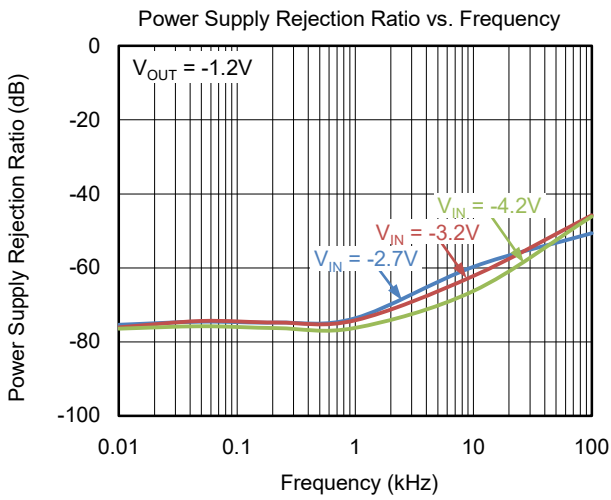
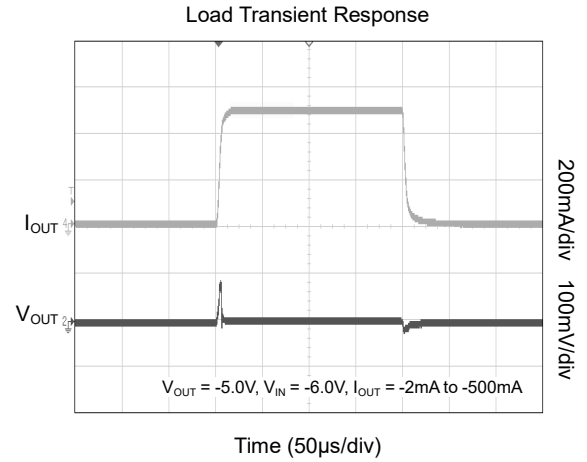
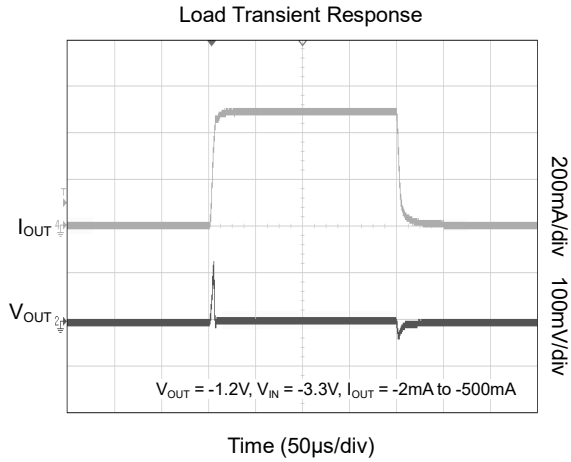

**TYPICAL PERFORMANCE CHARACTERISTICS (continued)**

$V_{IN} = (V_{OUT(NOM)} - 0.5V)$  or  $-2.7V$ , whichever is greater,  $V_{EN} = V_{IN}$ ,  $I_{OUT} = -10mA$ ,  $C_{IN} = C_{OUT} = 2.2\mu F$ ,  $T_J = +25^\circ C$ , unless otherwise noted.

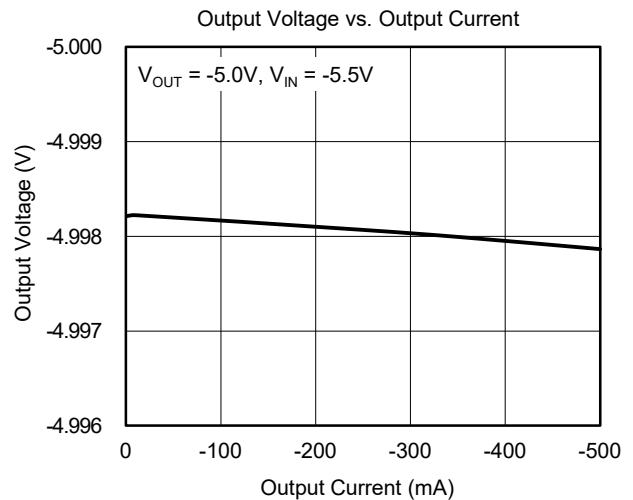
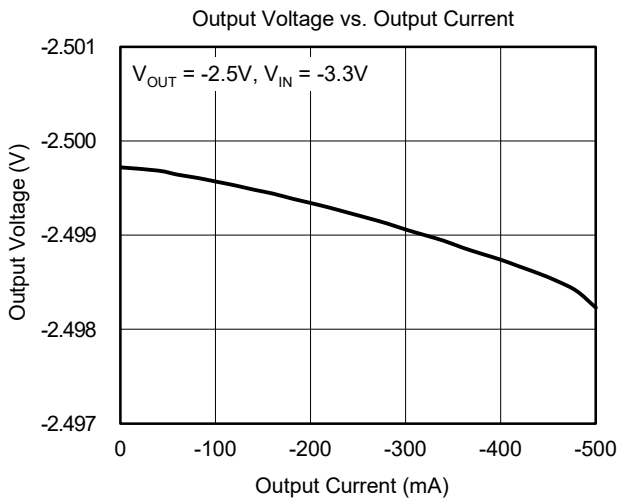
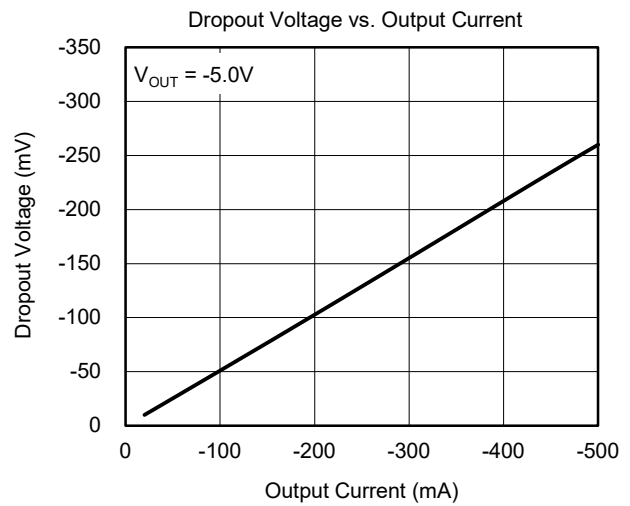
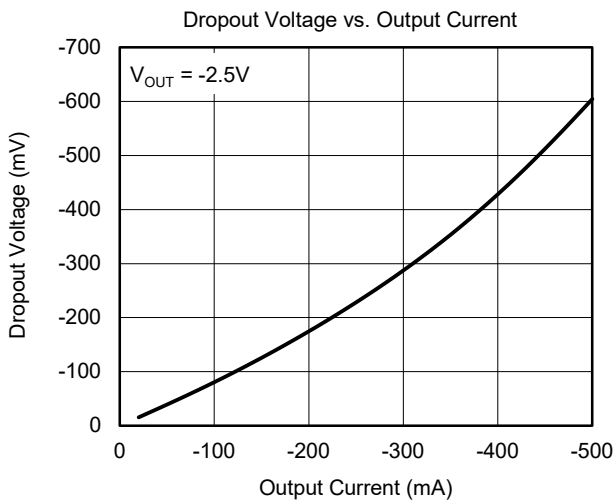
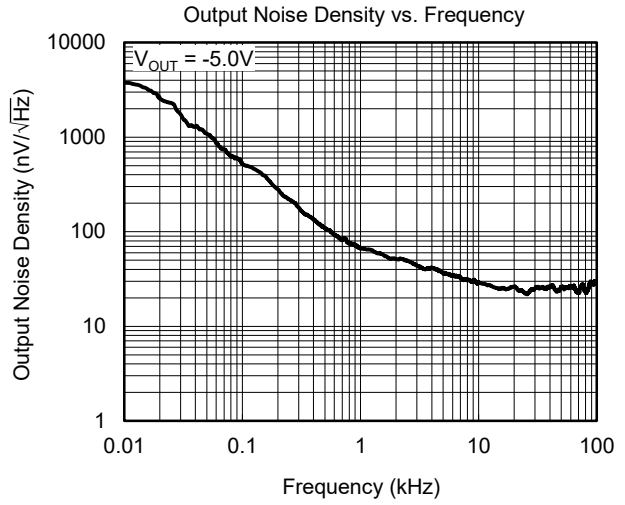
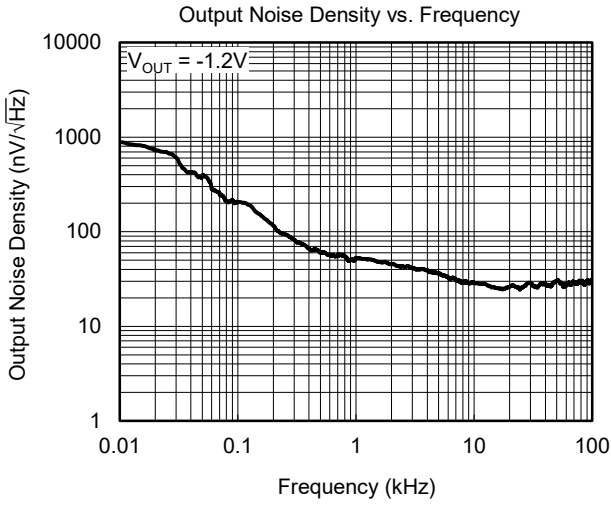

**TYPICAL PERFORMANCE CHARACTERISTICS (continued)**

$V_{IN} = (V_{OUT(NOM)} - 0.5V)$  or  $-2.7V$ , whichever is greater,  $V_{EN} = V_{IN}$ ,  $I_{OUT} = -10mA$ ,  $C_{IN} = C_{OUT} = 2.2\mu F$ ,  $T_J = +25^\circ C$ , unless otherwise noted.

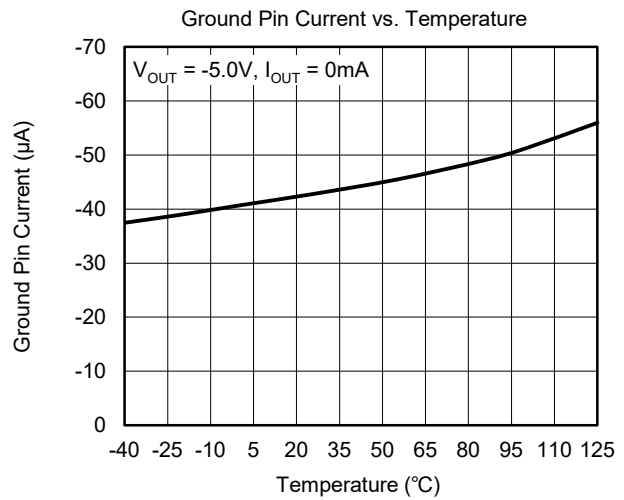
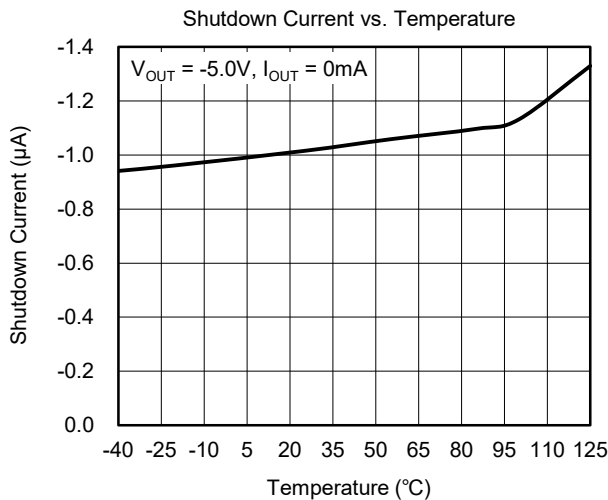
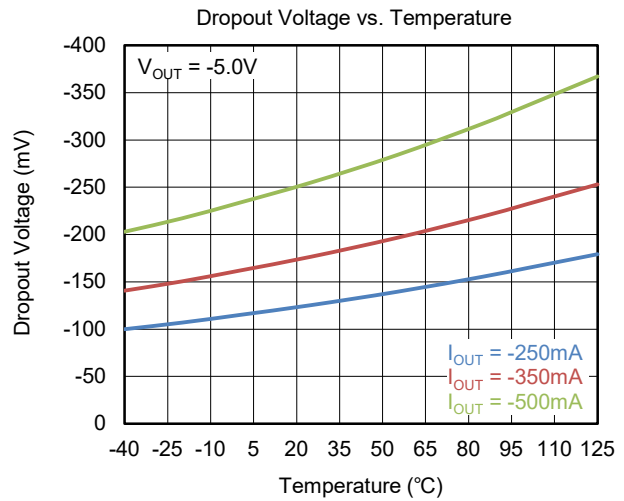
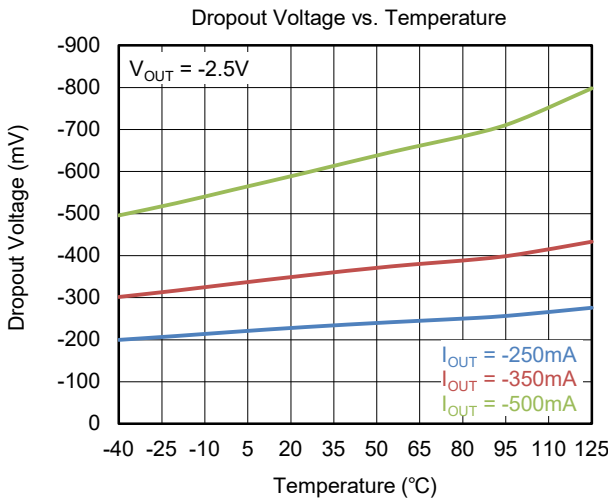
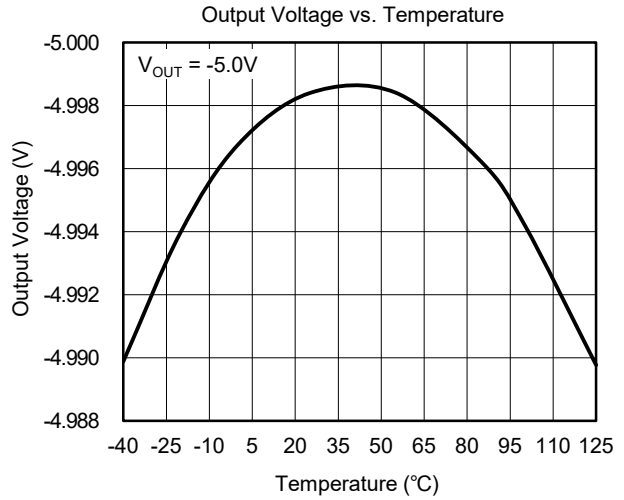
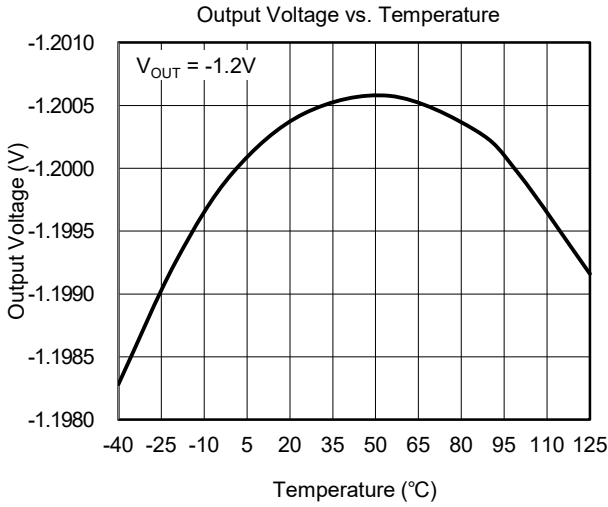

**TYPICAL PERFORMANCE CHARACTERISTICS (continued)**

$V_{IN} = (V_{OUT(NOM)} - 0.5V)$  or  $-2.7V$ , whichever is greater,  $V_{EN} = V_{IN}$ ,  $I_{OUT} = -10mA$ ,  $C_{IN} = C_{OUT} = 2.2\mu F$ ,  $T_J = +25^\circ C$ , unless otherwise noted.

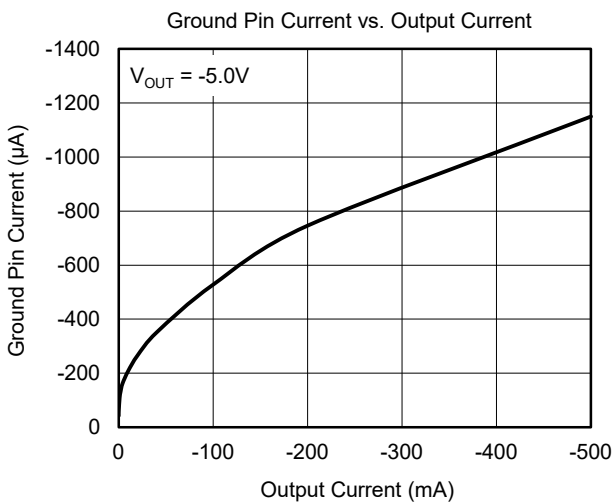
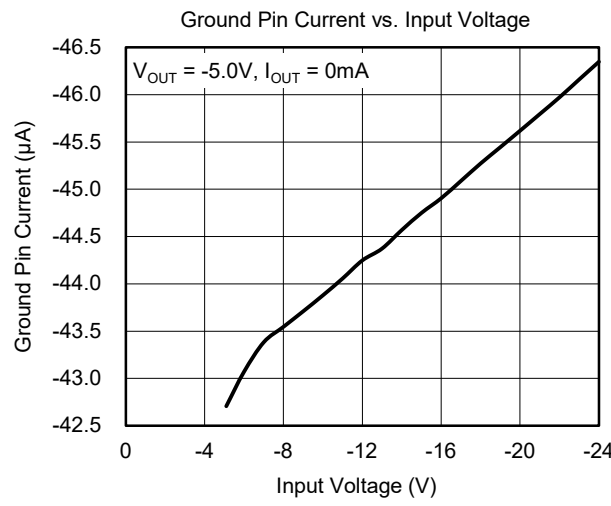
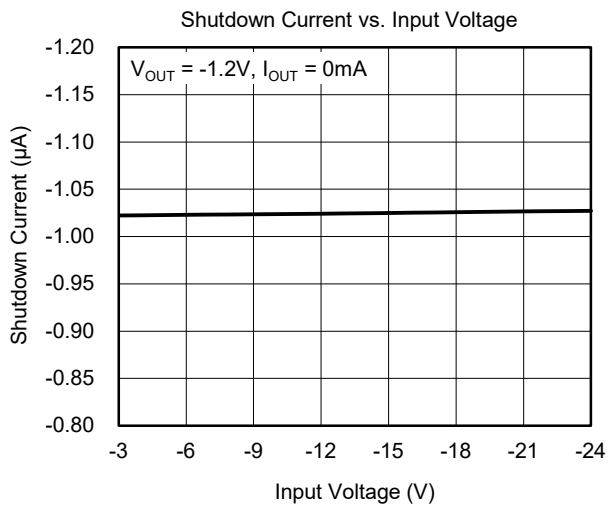
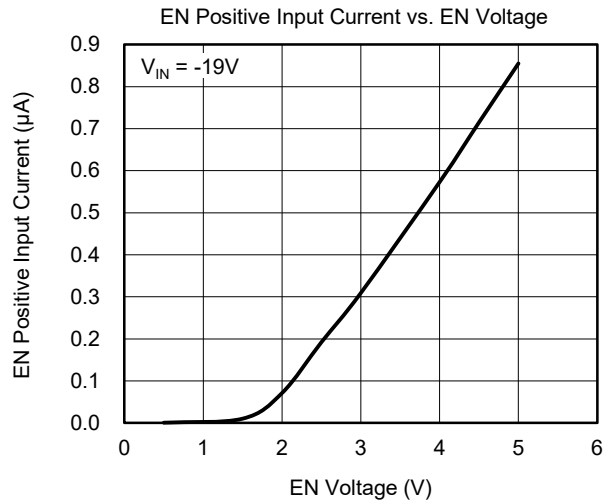
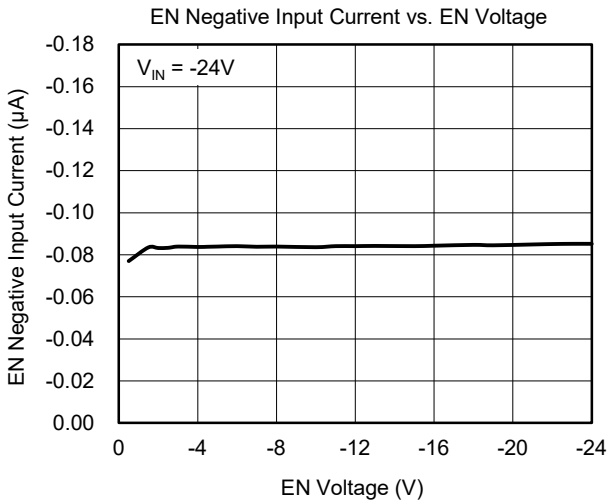

FUNCTIONAL BLOCK DIAGRAMS

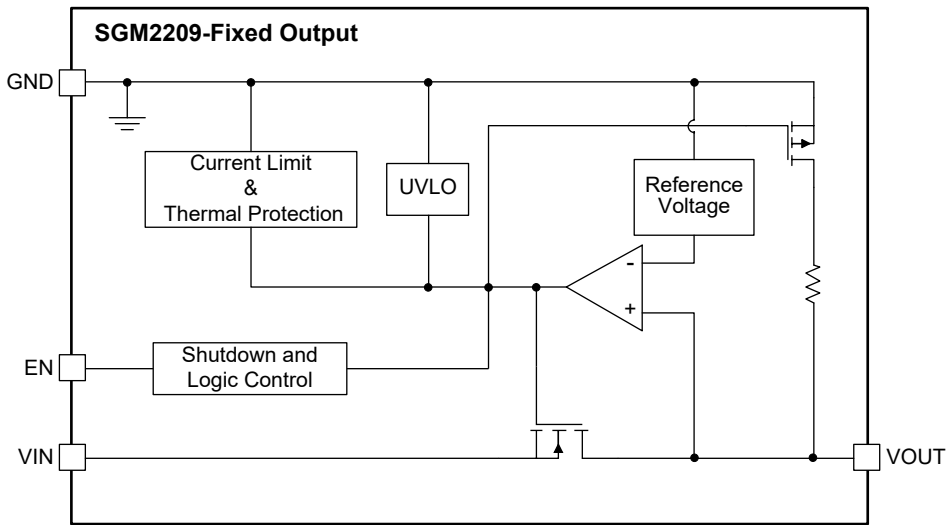

Figure 2. Fixed Output Voltage Internal Block Diagram

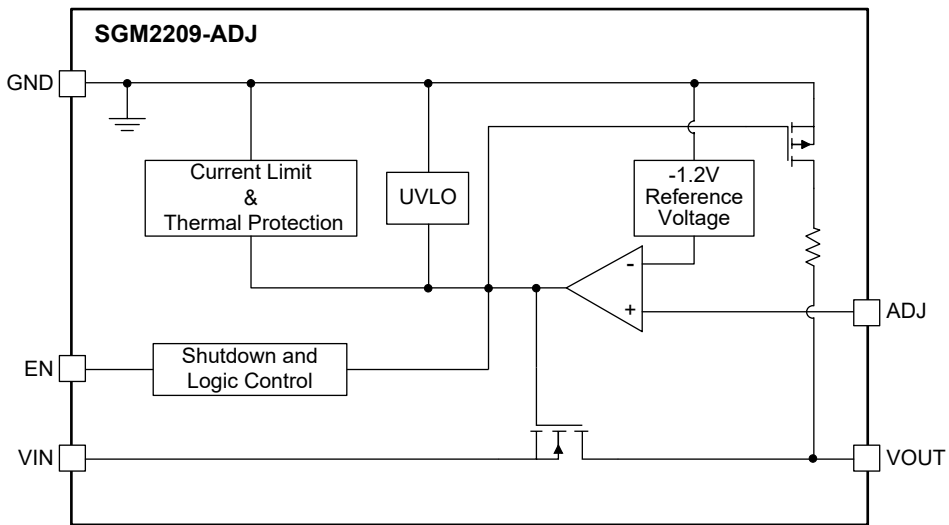

Figure 3. Adjustable Output Voltage Internal Block Diagram

**APPLICATION INFORMATION**

The SGM2209 is a low quiescent current, low noise and low dropout LDO and provides -500mA output current. These features make the device a reliable solution to solve many challenging problems in the generation of clean and accurate power supply. The high performance also makes the SGM2209 useful in a variety of applications. The SGM2209 provides the protection function for output overload, output short-circuit condition and overheating.

The SGM2209 provides an EN pin as an external chip enable control to enable/disable the device. When the regulator is in shutdown state, the shutdown current consumes as low as -1.1µA (TYP).

**Input Capacitor Selection (C<sub>IN</sub>)**

The input decoupling capacitor is necessary to be connected as close as possible to the VIN pin for ensuring the device stability. A 2.2µF or greater X7R or X5R ceramic capacitor is selected to get good dynamic performance.

When V<sub>IN</sub> is required to provide large current instantaneously, a large effective input capacitor is required. Multiple input capacitors can reduce the impact from input trace inductance. Adding more input capacitors is available to restrict the ringing and to keep it below the device absolute maximum ratings.

**Output Capacitor Selection (C<sub>OUT</sub>)**

The output capacitor should be located as close as possible to the VOUT pin. A 2.2µF or greater X7R or X5R ceramic capacitor is selected to get good dynamic performance. The minimum effective capacitance of C<sub>OUT</sub> that SGM2209 can remain stable is 1.5µF. For ceramic capacitor, temperature, DC bias and package size will change the effective capacitance, so enough margin of C<sub>OUT</sub> must be considered in design. Additionally, C<sub>OUT</sub> with larger capacitance and lower ESR will help increase the high frequency PSRR and improve the load transient response.

**Enable Pin Operation**

The EN pin is used to enable and disable the VOUT pin under normal operating conditions. Connect the EN pin to the VIN pin when using automatic startup.

When EN is at ±2.0V with respect to GND, the device is in active state. When EN is at 0V, the device is in shutdown state. In this state, a discharge resistor around 200kΩ connects to the VOUT pin and pulls the VOUT pin up to GND.

The EN pin of the SGM2209 is bipolar, even though the enable voltage can be positive or negative.

The typical hysteresis of the EN pin is shown in Figure 4. This feature is used to prevent on/off oscillations due to noise on the EN pin when it passes the threshold point.

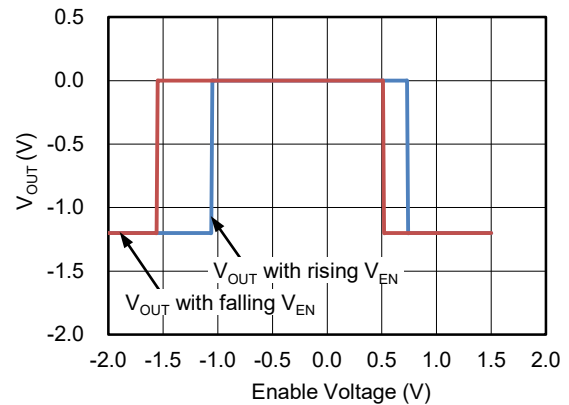

Figure 4. Typical EN Pin Operation

**Adjustable Regulator**

For the SGM2209-ADJ, set the output voltage by using a resistor divider as shown in Figure 5. Choose R<sub>FB2</sub> less than 120kΩ to maintain a 10µA minimum load. Calculate the value for the output voltage using the following equation:

$$V_{OUT} = -1.2V \times (1 + R_{FB1}/R_{FB2}) \tag{1}$$

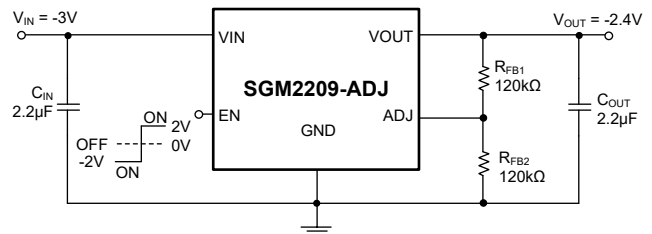

Figure 5. Adjustable Output Voltage Application

**APPLICATION INFORMATION (continued)**

**Output Current Limit and Short-Circuit Protection**

When overload events happen, the output current is internally limited to -1.05A (TYP). When the VOUT pin is shorted to ground, the short-circuit protection will limit the output current to -360mA (TYP).

**Thermal Shutdown**

The SGM2209 can detect the temperature of die. When the die temperature exceeds the threshold value of thermal shutdown, the SGM2209 will be in shutdown state and it will remain in this state until the die temperature decreases to +140°C.

**Power Dissipation (P<sub>D</sub>)**

Power dissipation (P<sub>D</sub>) of the SGM2209 can be calculated by the equation P<sub>D</sub> = (V<sub>IN</sub> - V<sub>OUT</sub>) × I<sub>OUT</sub>. The

maximum allowable power dissipation (P<sub>D(MAX)</sub>) of the SGM2209 is affected by many factors, including the difference between junction temperature and ambient temperature (T<sub>J(MAX)</sub> - T<sub>A</sub>), package thermal resistance from the junction to the ambient environment (θ<sub>JA</sub>), the rate of ambient airflow and PCB layout. P<sub>D(MAX)</sub> can be approximated by the following equation:

$$P_{D(MAX)} = (T_{J(MAX)} - T_A) / \theta_{JA} \quad (2)$$

**Layout Guidelines**

To get good PSRR, low output noise and high transient response performance, the input and output bypass capacitors must be placed as close as possible to the VIN pin and VOUT pin separately.

**REVISION HISTORY**

NOTE: Page numbers for previous revisions may differ from page numbers in the current version.

<b>APRIL 2024 – REV.A.1 to REV.A.2</b>	<b>Page</b>
Updated Features section .....	1
<hr/>	
<b>NOVEMBER 2022 – REV.A to REV.A.1</b>	<b>Page</b>
Updated Electrical Characteristics section .....	7
Updated Typical Performance Characteristics section .....	9
Updated Application Information section .....	15
<hr/>	
<b>Changes from Original (JANUARY 2020) to REV.A</b>	<b>Page</b>
Changed from product preview to production data .....	All

PACKAGE OUTLINE DIMENSIONS

TDFN-2x2-6AL

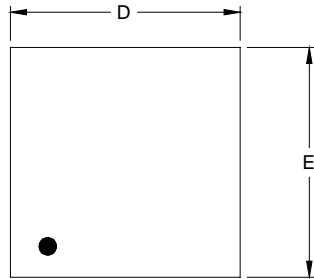

TOP VIEW

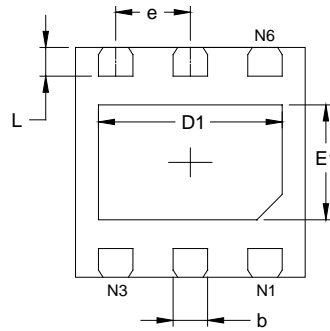

BOTTOM VIEW

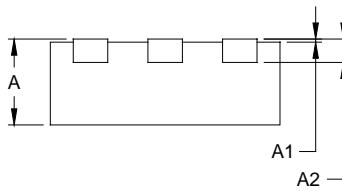

SIDE VIEW

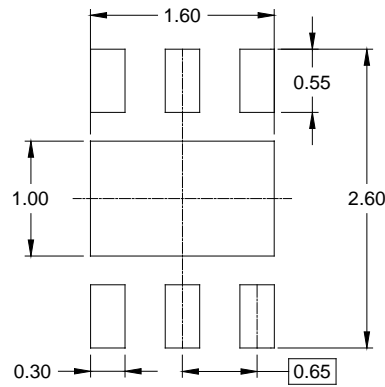

RECOMMENDED LAND PATTERN (Unit: mm)

Symbol	Dimensions In Millimeters		Dimensions In Inches	
	MIN	MAX	MIN	MAX
A	0.700	0.800	0.028	0.031
A1	0.000	0.050	0.000	0.002
A2	0.203 REF		0.008 REF	
D	1.900	2.100	0.075	0.083
D1	1.500	1.700	0.059	0.067
E	1.900	2.100	0.075	0.083
E1	0.900	1.100	0.035	0.043
b	0.250	0.350	0.010	0.014
e	0.650 BSC		0.026 BSC	
L	0.174	0.326	0.007	0.013

NOTE: This drawing is subject to change without notice.



PACKAGE OUTLINE DIMENSIONS

TDFN-3x3-8L

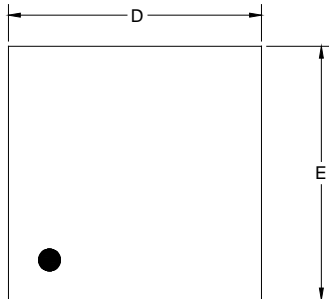

TOP VIEW

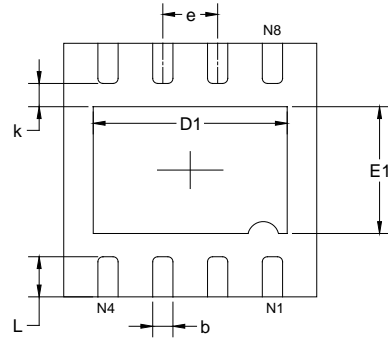

BOTTOM VIEW

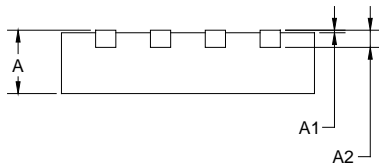

SIDE VIEW

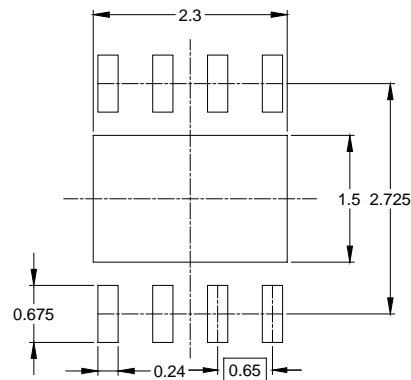

RECOMMENDED LAND PATTERN (Unit: mm)

Symbol	Dimensions In Millimeters		Dimensions In Inches	
	MIN	MAX	MIN	MAX
A	0.700	0.800	0.028	0.031
A1	0.000	0.050	0.000	0.002
A2	0.203 REF		0.008 REF	
D	2.900	3.100	0.114	0.122
D1	2.200	2.400	0.087	0.094
E	2.900	3.100	0.114	0.122
E1	1.400	1.600	0.055	0.063
k	0.200 MIN		0.008 MIN	
b	0.180	0.300	0.007	0.012
e	0.650 TYP		0.026 TYP	
L	0.375	0.575	0.015	0.023

NOTE: This drawing is subject to change without notice.

PACKAGE OUTLINE DIMENSIONS

SOT-23-5

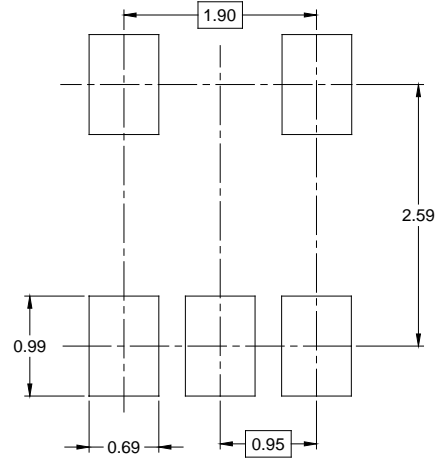
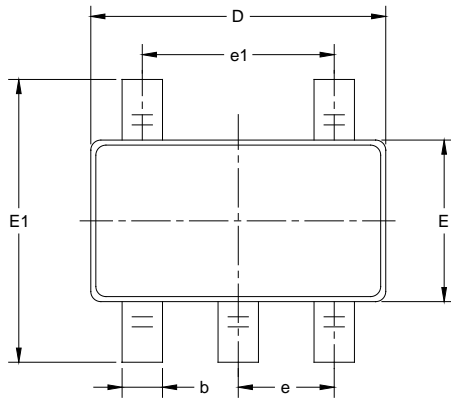

RECOMMENDED LAND PATTERN (Unit: mm)

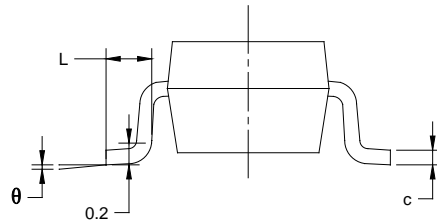
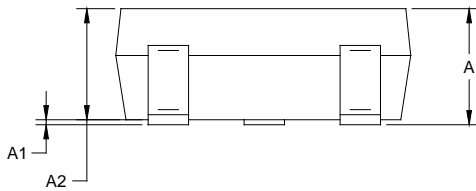

Symbol	Dimensions In Millimeters		Dimensions In Inches	
	MIN	MAX	MIN	MAX
A	1.050	1.250	0.041	0.049
A1	0.000	0.100	0.000	0.004
A2	1.050	1.150	0.041	0.045
b	0.300	0.500	0.012	0.020
c	0.100	0.200	0.004	0.008
D	2.820	3.020	0.111	0.119
E	1.500	1.700	0.059	0.067
E1	2.650	2.950	0.104	0.116
e	0.950 BSC		0.037 BSC	
e1	1.900 BSC		0.075 BSC	
L	0.300	0.600	0.012	0.024
$\theta$	0°	8°	0°	8°

NOTES:

1. Body dimensions do not include mode flash or protrusion.
2. This drawing is subject to change without notice.

# PACKAGE INFORMATION

## TAPE AND REEL INFORMATION

### REEL DIMENSIONS



### TAPE DIMENSIONS



NOTE: The picture is only for reference. Please make the object as the standard.

### KEY PARAMETER LIST OF TAPE AND REEL

Package Type	Reel Diameter	Reel Width W1 (mm)	A0 (mm)	B0 (mm)	K0 (mm)	P0 (mm)	P1 (mm)	P2 (mm)	W (mm)	Pin1 Quadrant
TDFN-2×2-6AL	7"	9.5	2.30	2.30	1.10	4.0	4.0	2.0	8.0	Q1
TDFN-3×3-8L	13"	12.4	3.35	3.35	1.13	4.0	8.0	2.0	12.0	Q1
SOT-23-5	7"	9.5	3.20	3.20	1.40	4.0	4.0	2.0	8.0	Q3

DD0001

# PACKAGE INFORMATION

## CARTON BOX DIMENSIONS



NOTE: The picture is only for reference. Please make the object as the standard.

## KEY PARAMETER LIST OF CARTON BOX

Reel Type	Length (mm)	Width (mm)	Height (mm)	Pizza/Carton
7" (Option)	368	227	224	8
7"	442	410	224	18
13"	386	280	370	5

DD0002