



SGM8306-1/SGM8306-2

High Speed, High Voltage, Rail-to-Rail Output Amplifiers

GENERAL DESCRIPTION

The SGM8306-1 (single) and SGM8306-2 (dual) are high speed and high voltage amplifiers. These devices are well suited for video or communication applications, where inputs or outputs are exposed externally.

The SGM8306-1/2 are optimized for high voltage operation from 4.5V to 16V single supply or $\pm 2.25V$ to $\pm 8V$ dual power supplies. These devices provide wide input common mode voltage range and rail-to-rail output swing. They consume low quiescent current of 7.8mA per amplifier.

The SGM8306-1/2 are designed for high speed applications. They offer a -3dB bandwidth of 100MHz, a small-signal bandwidth of 5.5MHz for -0.1dB gain flatness, and a high slew rate of 190V/ μ s.

The SGM8306-1 is available in Green SOT-23-5, SOIC-8 and MSOP-8 packages. The SGM8306-2 is available in Green SOIC-8 and MSOP-8 packages. They are specified over the extended -40°C to +125°C temperature range.

FEATURES

- **High Speed:**
 - ♦ **-3dB Bandwidth: 100MHz**
 - ♦ **-0.1dB Gain Flatness: 5.5MHz**
 - ♦ **Slew Rate: 190V/ μ s**
- **Stable when Gain ≥ 2**
- **Low Offset Voltage: 8mV (MAX)**
- **Low Differential Gain/Phase: 0.03%/0.1° at $V_S = \pm 8V$**
- **High Output Drive: $\pm 100mA$ (TYP)**
- **Rail-to-Rail Output**
- **Support Single or Dual Power Supplies:
4.5V to 16V or $\pm 2.25V$ to $\pm 8V$**
- **-40°C to +125°C Operating Temperature Range**
- **Small Packaging:**
 - SGM8306-1 Available in Green SOT-23-5, SOIC-8 and MSOP-8 Packages**
 - SGM8306-2 Available in Green SOIC-8 and MSOP-8 Packages**

APPLICATIONS

Video Processing
Video Drivers
Digital Cameras
CCD Imaging Systems
ADC Interfaces

PACKAGE/ORDERING INFORMATION

MODEL	PACKAGE DESCRIPTION	SPECIFIED TEMPERATURE RANGE	ORDERING NUMBER	PACKAGE MARKING	PACKING OPTION
SGM8306-1	SOT-23-5	-40°C to +125°C	SGM8306-1XN5G/TR	0AEXX	Tape and Reel, 3000
	SOIC-8	-40°C to +125°C	SGM8306-1XS8G/TR	SGM 83061XS8 XXXXX	Tape and Reel, 4000
	MSOP-8	-40°C to +125°C	SGM8306-1XMS8G/TR	SGM0AF XMS8 XXXXX	Tape and Reel, 4000
SGM8306-2	SOIC-8	-40°C to +125°C	SGM8306-2XS8G/TR	SGM 83062XS8 XXXXX	Tape and Reel, 4000
	MSOP-8	-40°C to +125°C	SGM8306-2XMS8G/TR	SGM0AG XMS8 XXXXX	Tape and Reel, 4000

MARKING INFORMATION

NOTE: XX = Date Code. XXXXX = Date Code, Trace Code and Vendor Code.

SOT-23-5

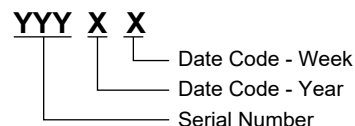

SOIC-8/MSOP-8

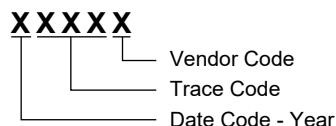

Green (RoHS & HSF): SG Micro Corp defines "Green" to mean Pb-Free (RoHS compatible) and free of halogen substances. If you have additional comments or questions, please contact your SGMICRO representative directly.

ABSOLUTE MAXIMUM RATINGS

- Supply Voltage, +V_S to -V_S -0.3V to 18V
- Input Common Mode Voltage Range (-V_S) - 0.3V to (+V_S) + 0.3V
- Differential Input Voltage ±2.5V
- Package Thermal Resistance
- SOT-23-5, θ_{JA} 186°C/W
- SOIC-8, θ_{JA} 143°C/W
- MSOP-8, θ_{JA} 158°C/W
- Junction Temperature +150°C
- Storage Temperature Range -65°C to +150°C
- Lead Temperature (Soldering, 10s) +260°C
- ESD Susceptibility
- HBM 8000V
- CDM 1000V

RECOMMENDED OPERATING CONDITIONS

- Operating Voltage Range 4.5V to 16V
- Operating Temperature Range -40°C to +125°C

OVERSTRESS CAUTION

Stresses beyond those listed in Absolute Maximum Ratings may cause permanent damage to the device. Exposure to absolute maximum rating conditions for extended periods may affect reliability. Functional operation of the device at any conditions beyond those indicated in the Recommended Operating Conditions section is not implied.

ESD SENSITIVITY CAUTION

This integrated circuit can be damaged if ESD protections are not considered carefully. SGMICRO recommends that all integrated circuits be handled with appropriate precautions. Failure to observe proper handling and installation procedures can cause damage. ESD damage can range from subtle performance degradation to complete device failure. Precision integrated circuits may be more susceptible to damage because even small parametric changes could cause the device not to meet the published specifications.

DISCLAIMER

SG Micro Corp reserves the right to make any change in circuit design, or specifications without prior notice.

PIN CONFIGURATIONS

SGM8306-1 (TOP VIEW)

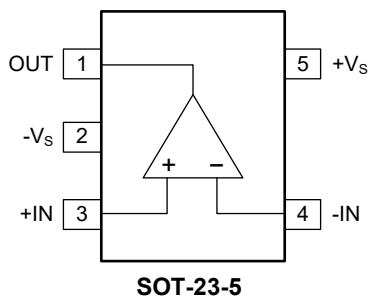

SGM8306-1 (TOP VIEW)

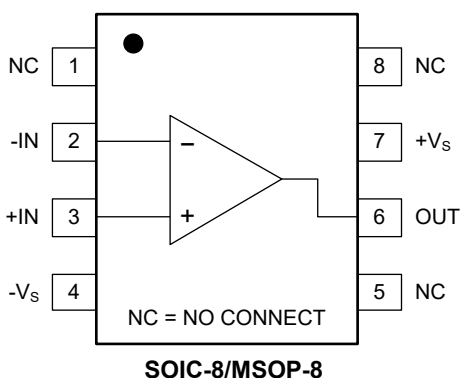

SGM8306-2 (TOP VIEW)

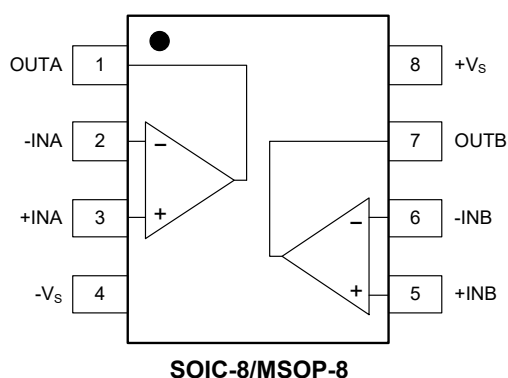

ELECTRICAL CHARACTERISTICS

($V_S = \pm 2.5V$, $V_{CM} = V_S/2$, $V_{OUT} = V_S/2$, $R_L = 150\Omega$ to $V_S/2$, $C_L = 10pF$, Full = $-40^\circ C$ to $+125^\circ C$, typical values are at $T_A = +25^\circ C$, unless otherwise noted.)

PARAMETER	SYMBOL	CONDITIONS	TEMP	MIN	TYP	MAX	UNITS
Input Characteristics							
Input Offset Voltage	V_{OS}		+25°C		0.3	8	mV
			Full			16	
Input Offset Voltage Drift	$\Delta V_{OS}/\Delta T$		Full		8.3		$\mu V/^\circ C$
Input Bias Current	I_B		+25°C		50	500	pA
Input Offset Current	I_{OS}		+25°C		50	500	pA
Input Common Mode Voltage Range	V_{CM}		Full	$(-V_S) - 0.1$		$(+V_S) - 1.5$	V
Common Mode Rejection Ratio	CMRR	$V_{CM} = (-V_S) - 0.1V$ to $(+V_S) - 1.5V$	+25°C	58	68		dB
			Full	55			
V_S Under-Voltage Lockout Threshold	V_{UVLO}	V_S rising	Full		3.59	3.83	V
		V_S falling	Full	3.14	3.46		
Open-Loop Voltage Gain	A_{OL}	$(-V_S) + 1V \leq V_{OUT} \leq (+V_S) - 1V$, $R_L = 75\Omega$	+25°C	58	61		dB
			Full	46			
		$(-V_S) + 0.6V \leq V_{OUT} \leq (+V_S) - 0.6V$, $R_L = 150\Omega$	+25°C	61	64		
			Full	50			
		$(-V_S) + 0.4V \leq V_{OUT} \leq (+V_S) - 0.4V$, $R_L = 2k\Omega$	+25°C	74	78		
			Full	63			
Output Characteristics							
Output Voltage Swing from Rail	V_{OH}	$R_L = 2k\Omega$	+25°C		$(+V_S) - 0.04$	$(+V_S) - 0.07$	V
			Full			$(+V_S) - 0.08$	
		$R_L = 150\Omega$	+25°C		$(+V_S) - 0.42$	$(+V_S) - 0.5$	
			Full			$(+V_S) - 0.65$	
		$R_L = 75\Omega$	+25°C		$(+V_S) - 0.73$	$(+V_S) - 0.85$	
			Full			$(+V_S) - 1.1$	
	V_{OL}	$R_L = 2k\Omega$	+25°C		0.03	0.05	
			Full			0.06	
		$R_L = 150\Omega$	+25°C		0.32	0.38	
			Full			0.50	
		$R_L = 75\Omega$	+25°C		0.57	0.65	
			Full			0.80	
Output Short-Circuit Current	I_{SC}	$R_L = 10\Omega$	+25°C	± 40	± 56		mA
Power Supply							
Quiescent Current/Amplifier	I_Q	$I_{OUT} = 0mA$	Full		7.8	10	mA
Power Supply Rejection Ratio	PSRR	$V_S = 4.5V$ to $16V$	+25°C	86	95		dB
			Full	81			

ELECTRICAL CHARACTERISTICS (continued)

($V_S = \pm 2.5V$, $V_{CM} = V_S/2$, $V_{OUT} = V_S/2$, $R_L = 150\Omega$ to $V_S/2$, $C_L = 10pF$, Full = $-40^\circ C$ to $+125^\circ C$, typical values are at $T_A = +25^\circ C$, unless otherwise noted.)

PARAMETER	SYMBOL	CONDITIONS	TEMP	MIN	TYP	MAX	UNITS
Dynamic Performance							
Small-Signal -3dB Bandwidth	BW_{SS}	$G = +1$	$+25^\circ C$		100		MHz
		$G = +2$	$+25^\circ C$		35		
Large-Signal -3dB Bandwidth	BW_{LS}	$G = +1$	$+25^\circ C$		45		MHz
		$G = +2$	$+25^\circ C$		35		
Small-Signal Bandwidth for -0.1dB Gain Flatness	$BW_{0.1dBSS}$	$G = +1$	$+25^\circ C$		5.5		MHz
		$G = +2$	$+25^\circ C$		6.5		
Large-Signal Bandwidth for -0.1dB Gain Flatness	$BW_{0.1dBLS}$	$G = +1$	$+25^\circ C$		5.5		MHz
		$G = +2$	$+25^\circ C$		8		
Gain-Bandwidth Product	GBP		$+25^\circ C$		48		MHz
Phase Margin	ϕ_O	$G = +2$	$+25^\circ C$		70		$^\circ$
Slew Rate	SR	$G = +1$, $f = 1kHz$, $2V_{P-P}$ output	$+25^\circ C$		190		$V/\mu s$
Settling Time to 0.1%	t_s	$f = 1kHz$, $2V_{P-P}$ output	$+25^\circ C$		320		ns
Differential Gain Error	DG	NTSC	$+25^\circ C$		0.3		%
Differential Phase Error	DP	NTSC	$+25^\circ C$		0.4		$^\circ$
Channel-to-Channel Crosstalk	Crosstalk	$f = 1kHz$, $V_{IN} = 200mV_{P-P}$	$+25^\circ C$		72		dB
Overload Recovery Time	ORT	$f = 1kHz$	$+25^\circ C$		25		ns
Noise							
Input Voltage Noise Density	e_n	$f = 1kHz$	$+25^\circ C$		105		nV/\sqrt{Hz}
		$f = 10kHz$	$+25^\circ C$		54		

ELECTRICAL CHARACTERISTICS (continued)

($V_S = \pm 8V$, $V_{CM} = V_S/2$, $V_{OUT} = V_S/2$, $R_L = 150\Omega$ to $V_S/2$, $C_L = 10pF$, Full = $-40^\circ C$ to $+125^\circ C$, typical values are at $T_A = +25^\circ C$, unless otherwise noted.)

PARAMETER	SYMBOL	CONDITIONS	TEMP	MIN	TYP	MAX	UNITS
Input Characteristics							
Input Offset Voltage	V_{OS}		+25°C		0.3	8	mV
			Full			16	
Input Offset Voltage Drift	$\Delta V_{OS}/\Delta T$		Full		8.3		$\mu V/^\circ C$
Input Bias Current	I_B		+25°C		50	500	pA
Input Offset Current	I_{OS}		+25°C		50	500	pA
Input Common Mode Voltage Range	V_{CM}		Full	$(-V_S) - 0.1$		$(+V_S) - 1.5$	V
Common Mode Rejection Ratio	CMRR	$V_{CM} = (-V_S) - 0.1V$ to $(+V_S) - 1.5V$	+25°C	70	80		dB
			Full	68			
Open-Loop Voltage Gain	A_{OL}	$(-V_S) + 5V \leq V_{OUT} \leq (+V_S) - 5V$, $R_L = 75\Omega$	+25°C	61	64		dB
			Full	50			
		$(-V_S) + 1.5V \leq V_{OUT} \leq (+V_S) - 1.5V$, $R_L = 150\Omega$	+25°C	68	70		
			Full	51			
		$(-V_S) + 0.4V \leq V_{OUT} \leq (+V_S) - 0.4V$, $R_L = 2k\Omega$	+25°C	78	81		
			Full	66			
Output Characteristics							
Output Voltage Swing from Rail	V_{OH}	$R_L = 2k\Omega$	+25°C		$(+V_S) - 0.14$	$(+V_S) - 0.2$	V
			Full			$(+V_S) - 0.25$	
		$R_L = 150\Omega$	+25°C		$(+V_S) - 1.37$	$(+V_S) - 1.7$	
			Full			$(+V_S) - 2.3$	
	V_{OL}	$R_L = 2k\Omega$	+25°C		0.12	0.15	
			Full			0.20	
		$R_L = 150\Omega$	+25°C		1.07	1.30	
			Full			1.70	
Output Short-Circuit Current	I_{SC}	$R_L = 10\Omega$	+25°C	± 65	± 100		mA
Power Supply							
Quiescent Current/Amplifier	I_Q	$I_{OUT} = 0mA$	Full		7.8	10	mA

ELECTRICAL CHARACTERISTICS (continued)

($V_S = \pm 8V$, $V_{CM} = V_S/2$, $V_{OUT} = V_S/2$, $R_L = 150\Omega$ to $V_S/2$, $C_L = 10pF$, Full = $-40^\circ C$ to $+125^\circ C$, typical values are at $T_A = +25^\circ C$, unless otherwise noted.)

PARAMETER	SYMBOL	CONDITIONS	TEMP	MIN	TYP	MAX	UNITS
Dynamic Performance							
Small-Signal -3dB Bandwidth	BW_{SS}	G = +1	+25°C		100		MHz
		G = +2	+25°C		32		
Large-Signal -3dB Bandwidth	BW_{LS}	G = +1	+25°C		45		MHz
		G = +2	+25°C		35		
Small-Signal Bandwidth for -0.1dB Gain Flatness	$BW_{0.1dBSS}$	G = +1	+25°C		5.5		MHz
		G = +2	+25°C		4.5		
Large-Signal Bandwidth for -0.1dB Gain Flatness	$BW_{0.1dBLS}$	G = +1	+25°C		5.7		MHz
		G = +2	+25°C		4.5		
Gain-Bandwidth Product	GBP		+25°C		48		MHz
Phase Margin	ϕ_O	G = +2	+25°C		70		°
Slew Rate	SR	G = +1, f = 1kHz, 2V _{P-P} output	+25°C		190		V/ μs
Settling Time to 0.1%	t_s	f = 1kHz, 2V _{P-P} output	+25°C		320		ns
Differential Gain Error	DG	NTSC	+25°C		0.03		%
Differential Phase Error	DP	NTSC	+25°C		0.1		°
Channel-to-Channel Crosstalk	Crosstalk	f = 1kHz, $V_{IN} = 200mV_{P-P}$	+25°C		72		dB
Overload Recovery Time	ORT	f = 1kHz	+25°C		20		ns
Noise							
Input Voltage Noise Density	e_n	f = 1kHz	+25°C		105		nV/ \sqrt{Hz}
		f = 10kHz	+25°C		54		

TYPICAL PERFORMANCE CHARACTERISTICS

At $T_A = +25^\circ\text{C}$, $V_S = \pm 8\text{V}$, $V_{CM} = 0\text{V}$ and $R_L = 150\Omega$ to GND, unless otherwise noted.

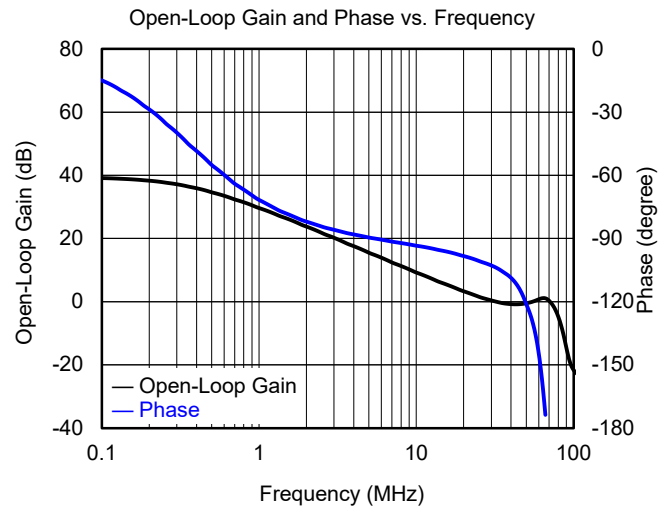
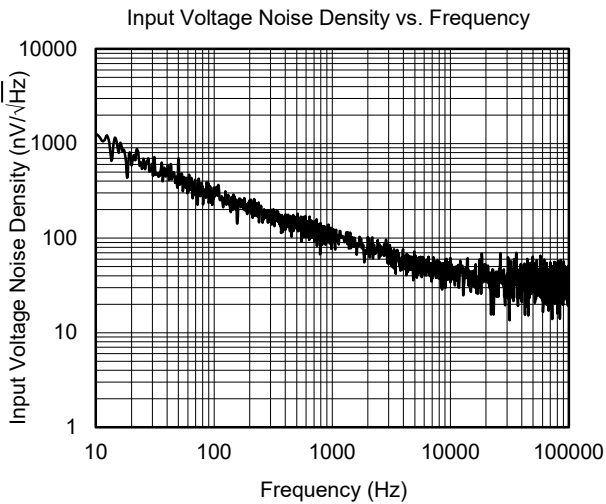
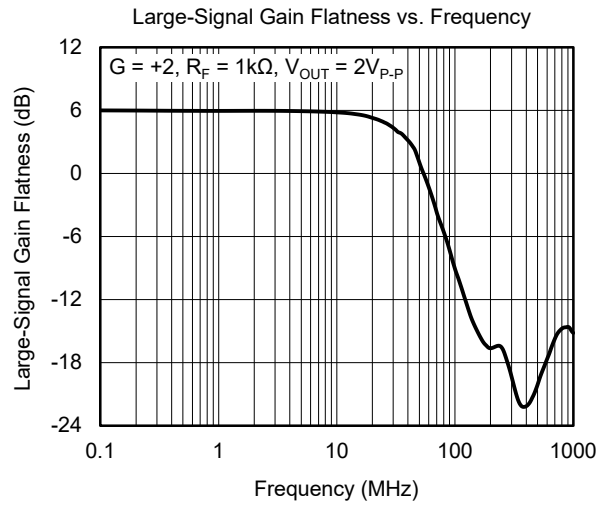
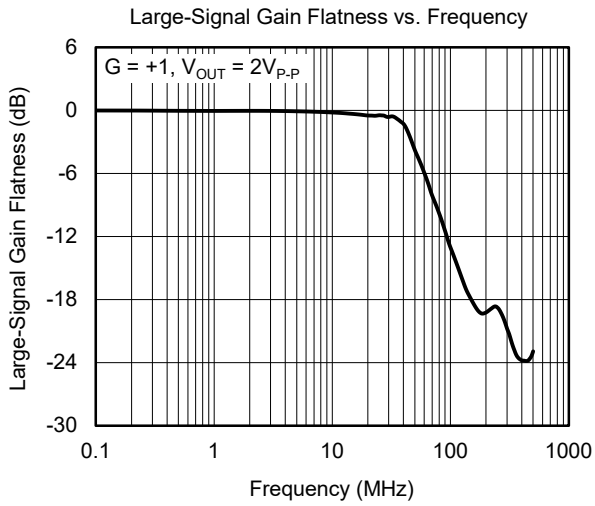
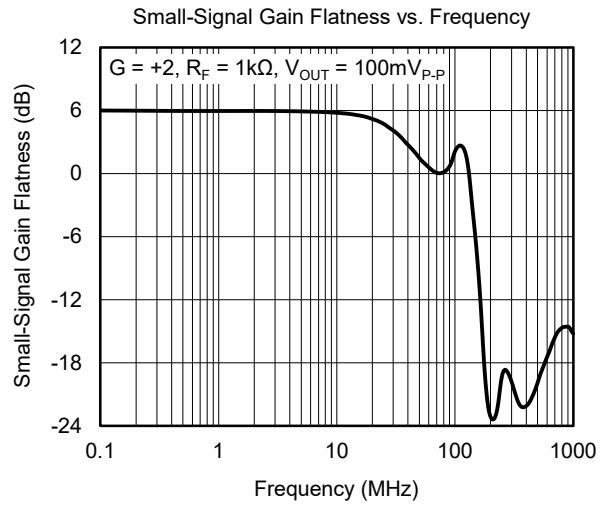
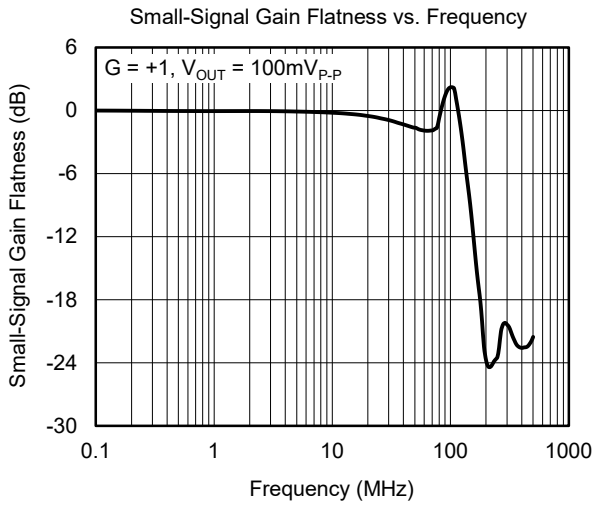

TYPICAL PERFORMANCE CHARACTERISTICS (continued)

At $T_A = +25^\circ\text{C}$, $V_S = \pm 8\text{V}$, $V_{CM} = 0\text{V}$ and $R_L = 150\Omega$ to GND, unless otherwise noted.

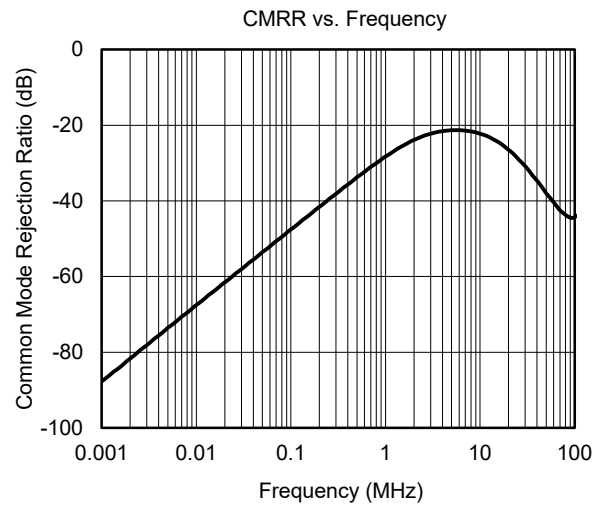
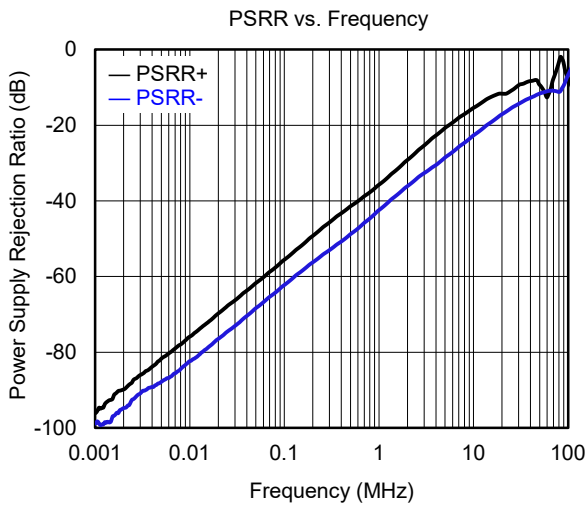

TYPICAL PERFORMANCE CHARACTERISTICS (continued)

At $T_A = +25^\circ\text{C}$, $V_S = \pm 8\text{V}$, $V_{CM} = 0\text{V}$ and $R_L = 150\Omega$ to GND, unless otherwise noted.

Small-Signal Pulse Response

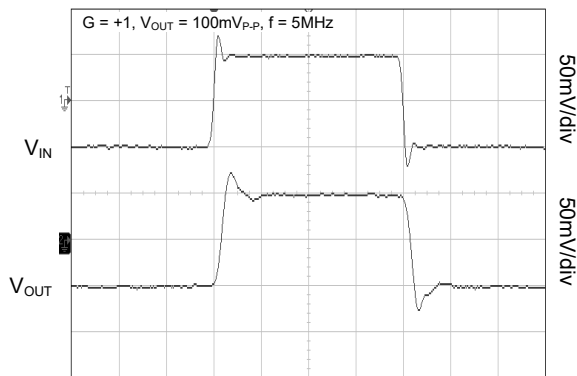

Time (25ns/div)

Large-Signal Pulse Response

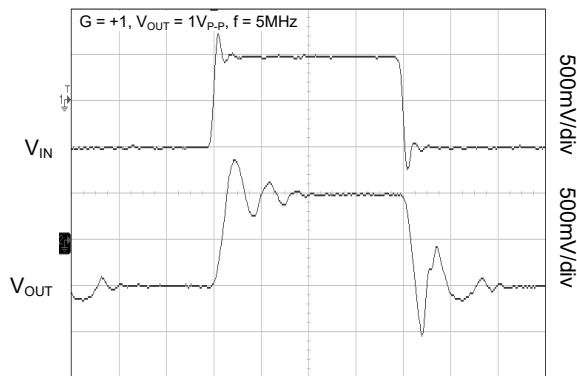

Time (25ns/div)

Small-Signal Pulse Response

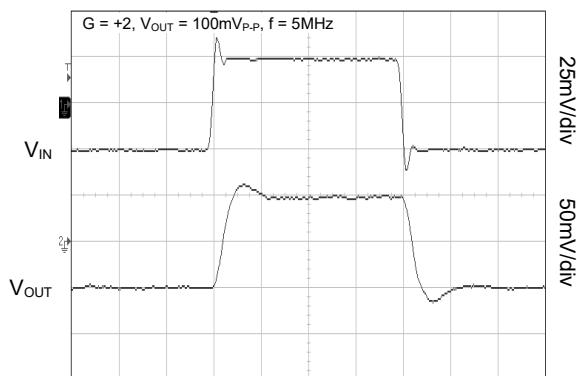

Time (25ns/div)

Large-Signal Pulse Response

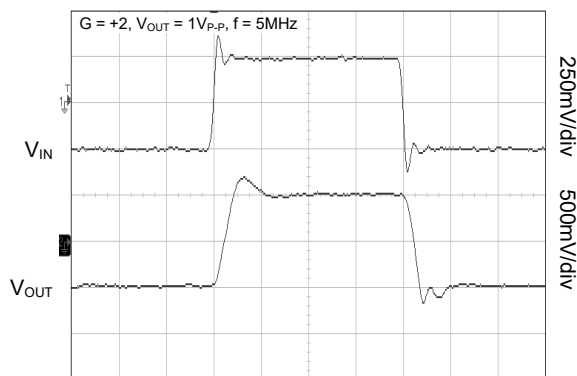

Time (25ns/div)

Small-Signal Pulse Response

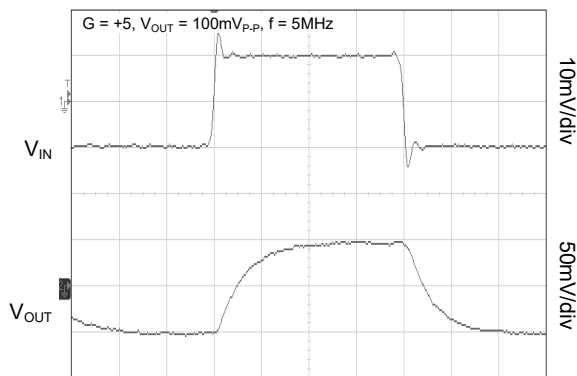

Time (25ns/div)

Large-Signal Pulse Response

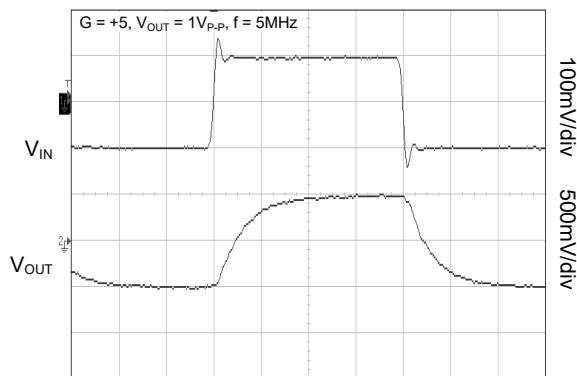

Time (25ns/div)

APPLICATION INFORMATION

Typical Application Circuit

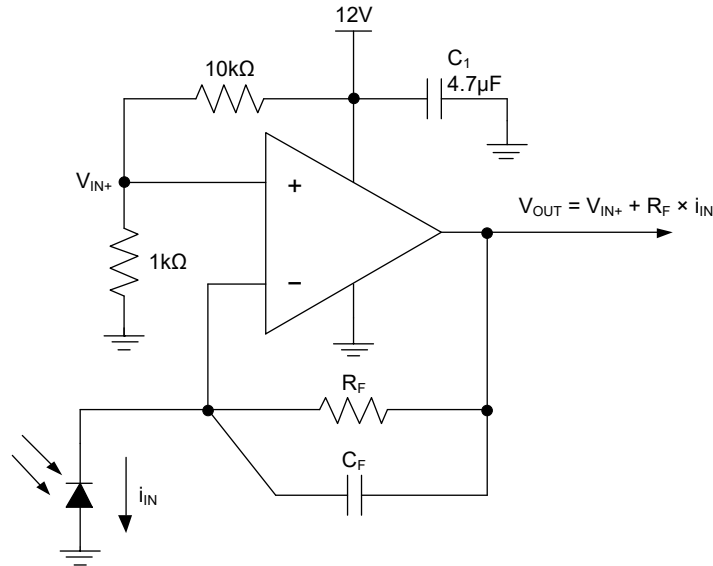

Figure 1. Transimpedance Amplifier for I to V Conversion

Layout and Power Supply Bypassing

The SGM8306-1/2 can operate on a wide supply range from 4.5V to 16V or $\pm 2.25V$ to $\pm 8V$. A good PCB layout is important for the performance of the devices. The bypass capacitor of $0.1\mu F$ should be closed enough to both supply pins. It is recommended to use micro-strip and strip line techniques to achieve full bandwidth. The PCB is designed with a frequency higher than 1GHz to prevent amplifier performance from being affected. The inputs and outputs should be designed carefully to reduce the parasitic capacitor. Whether the constant impedance board is used or not, the following layout suggestions should be considered:

- ◆ Wire-wrap boards are too inductive, so they are not recommended.
- ◆ In order to reduce parasitic capacitance and inductance, IC socket is not recommended.
- ◆ Surface-mount can achieve better high-frequency performance. It should be considered instead of through-hole components.
- ◆ The PCB should have two layers at least and as few voids as possible.
- ◆ Signal traces should be kept as short and straight as possible at all corners, without turning 90° .

REVISION HISTORY

NOTE: Page numbers for previous revisions may differ from page numbers in the current version.

Changes from Original (NOVEMBER 2023) to REV.A

Page

Changed from product preview to production data.....All

PACKAGE INFORMATION

PACKAGE OUTLINE DIMENSIONS

SOT-23-5

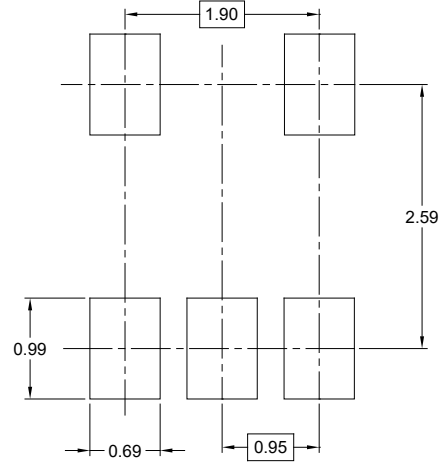
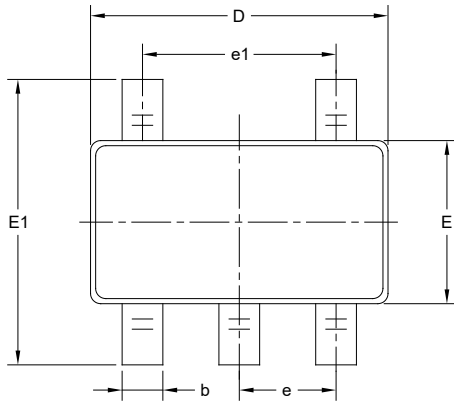

RECOMMENDED LAND PATTERN (Unit: mm)

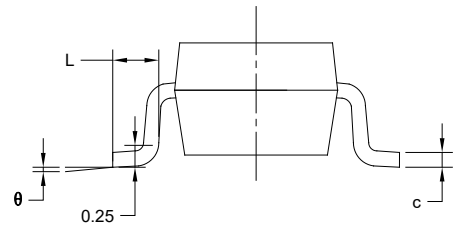
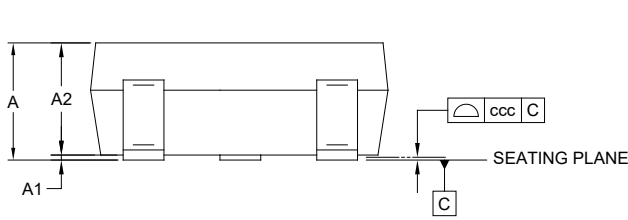

Symbol	Dimensions In Millimeters		
	MIN	MOD	MAX
A	-	-	1.450
A1	0.000	-	0.150
A2	0.900	-	1.300
b	0.300	-	0.500
c	0.080	-	0.220
D	2.750	-	3.050
E	1.450	-	1.750
E1	2.600	-	3.000
e	0.950 BSC		
e1	1.900 BSC		
L	0.300	-	0.600
θ	0°	-	8°
ccc	0.100		

NOTES:

1. This drawing is subject to change without notice.
2. The dimensions do not include mold flashes, protrusions or gate burrs.
3. Reference JEDEC MO-178.

PACKAGE OUTLINE DIMENSIONS

SOIC-8

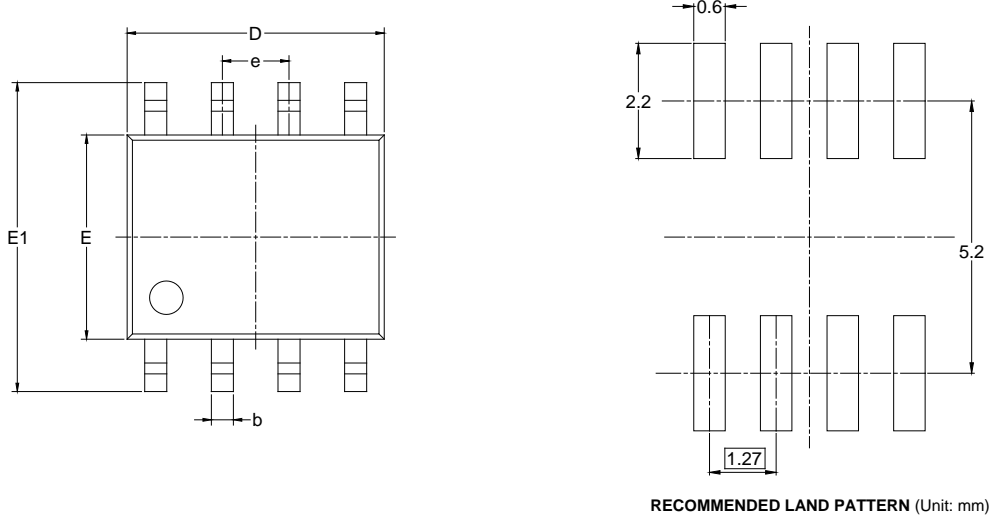

Symbol	Dimensions In Millimeters		Dimensions In Inches	
	MIN	MAX	MIN	MAX
A	1.350	1.750	0.053	0.069
A1	0.100	0.250	0.004	0.010
A2	1.350	1.550	0.053	0.061
b	0.330	0.510	0.013	0.020
c	0.170	0.250	0.006	0.010
D	4.700	5.100	0.185	0.200
E	3.800	4.000	0.150	0.157
E1	5.800	6.200	0.228	0.244
e	1.27 BSC		0.050 BSC	
L	0.400	1.270	0.016	0.050
θ	0°	8°	0°	8°

NOTES:
 1. Body dimensions do not include mode flash or protrusion.
 2. This drawing is subject to change without notice.

PACKAGE OUTLINE DIMENSIONS

MSOP-8

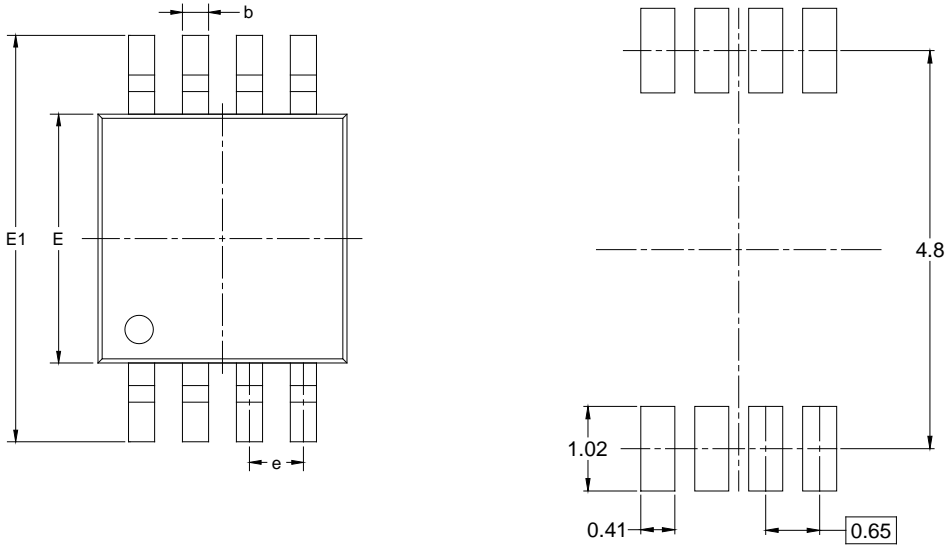

RECOMMENDED LAND PATTERN (Unit: mm)

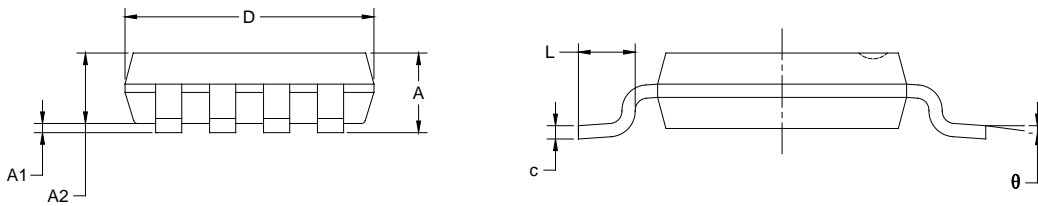

Symbol	Dimensions In Millimeters		Dimensions In Inches	
	MIN	MAX	MIN	MAX
A	0.820	1.100	0.032	0.043
A1	0.020	0.150	0.001	0.006
A2	0.750	0.950	0.030	0.037
b	0.250	0.380	0.010	0.015
c	0.090	0.230	0.004	0.009
D	2.900	3.100	0.114	0.122
E	2.900	3.100	0.114	0.122
E1	4.750	5.050	0.187	0.199
e	0.650 BSC		0.026 BSC	
L	0.400	0.800	0.016	0.031
θ	0°	6°	0°	6°

NOTES:

1. Body dimensions do not include mode flash or protrusion.
2. This drawing is subject to change without notice.

TAPE AND REEL INFORMATION

REEL DIMENSIONS



TAPE DIMENSIONS



NOTE: The picture is only for reference. Please make the object as the standard.

KEY PARAMETER LIST OF TAPE AND REEL

Package Type	Reel Diameter	Reel Width W1 (mm)	A0 (mm)	B0 (mm)	K0 (mm)	P0 (mm)	P1 (mm)	P2 (mm)	W (mm)	Pin1 Quadrant
SOT-23-5	7"	9.5	3.20	3.20	1.40	4.0	4.0	2.0	8.0	Q3
SOIC-8	13"	12.4	6.40	5.40	2.10	4.0	8.0	2.0	12.0	Q1
MSOP-8	13"	12.4	5.20	3.30	1.50	4.0	8.0	2.0	12.0	Q1

DD0001

PACKAGE INFORMATION

CARTON BOX DIMENSIONS



NOTE: The picture is only for reference. Please make the object as the standard.

KEY PARAMETER LIST OF CARTON BOX

Reel Type	Length (mm)	Width (mm)	Height (mm)	Pizza/Carton
7" (Option)	368	227	224	8
7"	442	410	224	18
13"	386	280	370	5

DD0002