

GENERAL DESCRIPTION

The SGM42513 is an integrated driver IC for driving motors and coils in industrial applications. The IN1 and IN2 pins allow simple interfacing to controller circuits.

Internal protection functions are provided for under-voltage lockout (UVLO), over-current protection (OCP) and over-temperature protection (OTP).

The SGM42513 is available in a Green TSOT-23-6 package. It operates over an ambient temperature range of -40°C to +125°C.

APPLICATIONS

- Robot
- Utility Meter
- Solenoid

FEATURES

- **H-Bridge or Two Half-Bridges**
- **Sleep Mode Supply Current: 140nA (TYP)**
- **Internal OC/UV/OT Protections**
 - ♦ **Over-Current Threshold Options:**
0.45A/0.9A/1.5A
 - ♦ **Under-Voltage Threshold Options:**
1.75V/2.8V/3.6V
- **Up to 5.5V Supply Range for Applications Powered by:**
 - ♦ **1 Li+/Poly Cell**
 - ♦ **1/2/3 Dry Cell(s)**
 - ♦ **1 LiSOCl₂ Cell**
- **-40°C to +125°C Operating Temperature Range**
- **Available in a Green TSOT-23-6 Package**

TYPICAL APPLICATION

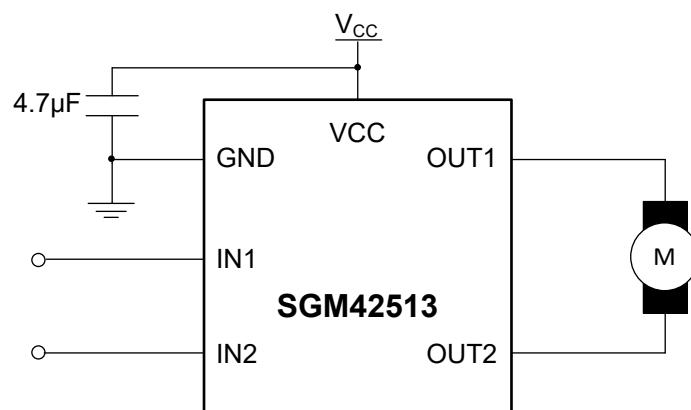

PACKAGE/ORDERING INFORMATION

MODEL	PACKAGE DESCRIPTION	SPECIFIED TEMPERATURE RANGE	ORDERING NUMBER	PACKAGE MARKING	PACKING OPTION
SGM42513A-1.75	TSOT-23-6	-40°C to +125°C	SGM42513A-1.75XTN6G/TR	MO7XX	Tape and Reel, 3000
SGM42513A-2.8	TSOT-23-6	-40°C to +125°C	SGM42513A-2.8XTN6G/TR	MO8XX	Tape and Reel, 3000
SGM42513A-3.6	TSOT-23-6	-40°C to +125°C	SGM42513A-3.6XTN6G/TR	MO9XX	Tape and Reel, 3000
SGM42513B-1.75	TSOT-23-6	-40°C to +125°C	SGM42513B-1.75XTN6G/TR	MOAXX	Tape and Reel, 3000
SGM42513B-2.8	TSOT-23-6	-40°C to +125°C	SGM42513B-2.8XTN6G/TR	MOBXX	Tape and Reel, 3000
SGM42513B-3.6	TSOT-23-6	-40°C to +125°C	SGM42513B-3.6XTN6G/TR	MOCXX	Tape and Reel, 3000
SGM42513C-1.75	TSOT-23-6	-40°C to +125°C	SGM42513C-1.75XTN6G/TR	MODXX	Tape and Reel, 3000
SGM42513C-2.8	TSOT-23-6	-40°C to +125°C	SGM42513C-2.8XTN6G/TR	MHBXX	Tape and Reel, 3000
SGM42513C-3.6	TSOT-23-6	-40°C to +125°C	SGM42513C-3.6XTN6G/TR	MHCXX	Tape and Reel, 3000

MARKING INFORMATION

NOTE: XX = Date Code.

YYY X X

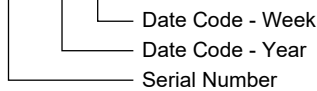

Green (RoHS & HSF): SG Micro Corp defines "Green" to mean Pb-Free (RoHS compatible) and free of halogen substances. If you have additional comments or questions, please contact your SGMICRO representative directly.

SELECTABLE MODEL

MODEL	OVER-CURRENT PROTECTION THRESHOLD (A)	UNDER-VOLTAGE PROTECTION THRESHOLD (V)
SGM42513A-1.75	1.5	1.75
SGM42513A-2.8	1.5	2.8
SGM42513A-3.6	1.5	3.6
SGM42513B-1.75	0.9	1.75
SGM42513B-2.8	0.9	2.8
SGM42513B-3.6	0.9	3.6
SGM42513C-1.75	0.45	1.75
SGM42513C-2.8	0.45	2.8
SGM42513C-3.6	0.45	3.6

ABSOLUTE MAXIMUM RATINGS

V _{CC}	-0.3V to 6V
Digital Input Pin Voltage Range	-0.3V to V _{CC} + 0.3V
Package Thermal Resistance	
TSOT-23-6, θ_{JA}	217.8°C/W
Junction Temperature.....	+150°C
Storage Temperature Range	-65°C to +150°C
Lead Temperature (Soldering, 10s).....	+260°C
ESD Susceptibility	
HBM.....	6000V
MM.....	400V
CDM	1000V

RECOMMENDED OPERATING CONDITIONS

V _{CC}	1.9V to 5.5V
Digital Input Pin Voltage Range	0V to 5.5V
Ambient Temperature Range.....	-40°C to +125°C

OVERSTRESS CAUTION

Stresses beyond those listed in Absolute Maximum Ratings may cause permanent damage to the device. Exposure to absolute maximum rating conditions for extended periods may affect reliability. Functional operation of the device at any conditions beyond those indicated in the Recommended Operating Conditions section is not implied.

ESD SENSITIVITY CAUTION

This integrated circuit can be damaged if ESD protections are not considered carefully. SGMICRO recommends that all integrated circuits be handled with appropriate precautions. Failure to observe proper handling and installation procedures can cause damage. ESD damage can range from subtle performance degradation to complete device failure. Precision integrated circuits may be more susceptible to damage because even small parametric changes could cause the device not to meet the published specifications.

DISCLAIMER

SG Micro Corp reserves the right to make any change in circuit design, or specifications without prior notice.

PIN CONFIGURATION

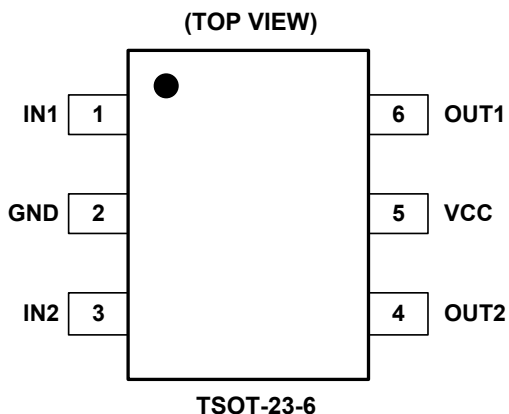

PIN DESCRIPTION

NAME	TYPE	FUNCTION
IN1	I	Bridge Input 1. Logic input controls state of OUT1 and OUT2.
GND	G	Ground.
IN2	I	Bridge Input 2. Logic input controls state of OUT1 and OUT2.
OUT2	O	H-Bridge Output 2.
VCC	P	Power Input. A 4.7 μ F (MIN) ceramic bypass capacitor to GND is recommended.
OUT1	O	H-Bridge Output 1.

NOTE: I: input, O: output, G: ground, P: power for the circuit.

ELECTRICAL CHARACTERISTICS

(T_A = +25°C, V_{CC} = 5V, Full = -40°C to +125°C, unless otherwise noted.)

PARAMETER	SYMBOL	CONDITIONS	TEMP	MIN	TYP	MAX	UNITS
Power Supplies							
Power Supply Voltage	V _{CC}		+25°C	1.9		5.5	V
Digital Input Voltage Range (IN1, IN2)	V _{IN}		+25°C	0		5.5	V
Power Supply Current	I _{VCC}	No PWM	+25°C		40	70	μA
Sleep Mode Supply Current	I _{VCCQ}	N1 = IN2 = GND	+25°C		140	500	nA
VCC Under-Voltage Lockout Voltage	V _{UVLO}	SGM42513A/B/C-1.75	+25°C		1.7	1.9	V
		SGM42513A/B/C-2.8	+25°C		1.95	2.15	
		SGM42513A/B/C-3.6	+25°C		1.7	1.85	
VCC Under-Voltage Lockout Voltage Hysteresis	V _{HYS}		+25°C		100		mV
VCC Under-Voltage Protection Voltage	V _{UVP}	SGM42513A/B/C-1.75	+25°C		1.75	1.9	V
		SGM42513A/B/C-2.8	+25°C		2.8	3.05	
		SGM42513A/B/C-3.6	+25°C		3.6	3.75	
VCC Under-Voltage Protection Voltage Hysteresis	V _{HYS}		+25°C		100		mV
Logic Level Inputs							
Input Low Voltage	V _{IL}		Full			0.4	V
Input High Voltage	V _{IH}		Full	1.6			V
Input Low Current	I _{IL}	V _{IN} = 0V	+25°C	-500		500	nA
Input High Weak Pull-Down Current	I _{IH_weak}	V _{IN} = 5.5V	+25°C		60	85	μA
Input High Strong Pull-Down Current	I _{IH_strong}	V _{IN} = 0.88V	+25°C		220	350	μA
Input Deglitch Time	t _{DEG}		+25°C		300		ns
H-Bridge FETs							
HS FET On-Resistance	R _{DS(ON)}	SGM42513A-X, I _{OUT} = 200mA	+25°C		365		mΩ
			Full			520	
		SGM42513B-X, I _{OUT} = 200mA	+25°C		370		
			Full			540	
		SGM42513C-X, I _{OUT} = 200mA	+25°C		395		
			Full			570	
LS FET On-Resistance	R _{DS(ON)}	SGM42513A-X, I _{OUT} = -200mA	+25°C		180		mΩ
			Full			320	
		SGM42513B-X, I _{OUT} = -200mA	+25°C		185		
			Full			340	
		SGM42513C-X, I _{OUT} = -200mA	+25°C		210		
			Full			360	
Off-State Leakage Current	I _{OFF}	V _{OUT} = 0V or 5.5V	+25°C	-500		500	nA

ELECTRICAL CHARACTERISTICS (continued)(T_A = +25°C, V_{CC} = 5V, Full = -40°C to +125°C, unless otherwise noted.)

PARAMETER	SYMBOL	CONDITIONS	TEMP	MIN	TYP	MAX	UNITS
Motor Driver							
Rise Time	t _R	R _L = 16Ω to GND, 10% to 90% V _{CC}	+25°C		125		ns
Fall Time	t _F	R _L = 16Ω to V _{CC} , 90% to 10% V _{CC}	+25°C		155		ns
Propagation Delay INx to OUTx	t _{PROP}		+25°C		1		μs
Dead Time ⁽¹⁾	t _{DEAD}		+25°C		255		ns
Protection Circuits							
Over-Current Protection Trip Level	I _{OCP}	SGM42513A-X	+25°C		1.5		A
		SGM42513B-X	+25°C		0.9		
		SGM42513C-X	+25°C		0.45		
Thermal Shutdown							
Thermal Shutdown Temperature	T _{TSD}				165		°C
Thermal Shutdown Temperature Hysteresis	T _{HYS}				30		°C
nSLEEP Mode							
Time to Enter Sleep Mode	t _{SLEEP}		+25°C	60		105	ms
Wake Time	t _{WAKE}	IN1/IN2 inactive high to H-bridge on	+25°C			8.5	ms

NOTE: 1. Internal dead time. External implementation is not necessary.

TYPICAL PERFORMANCE CHARACTERISTICS

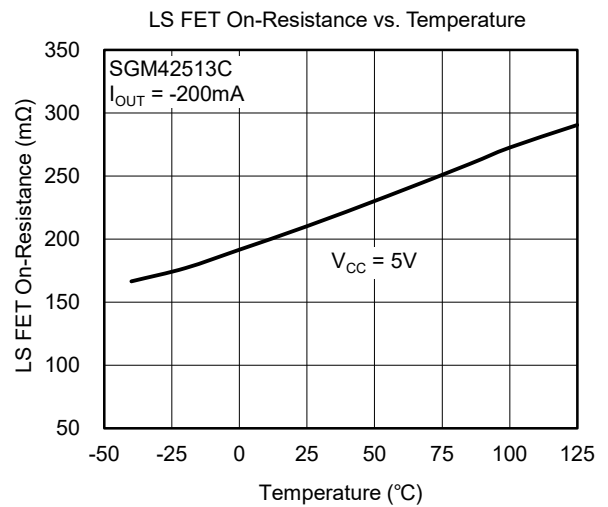
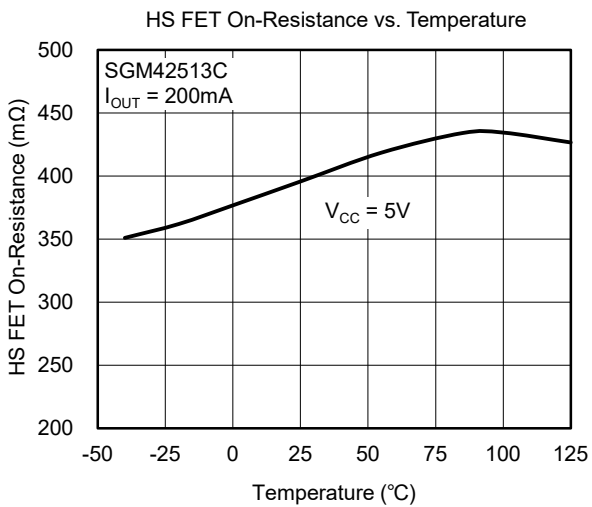
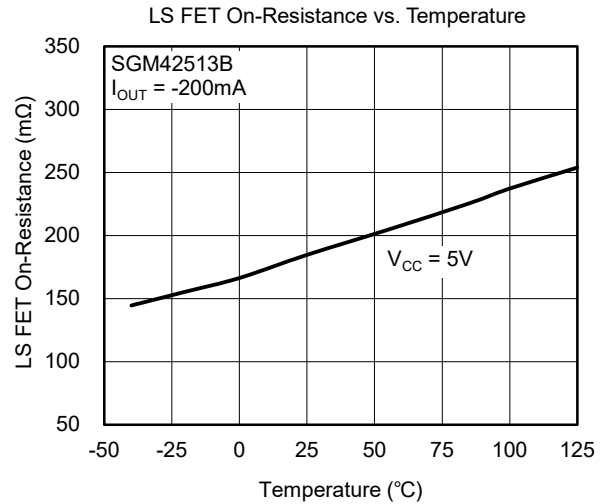
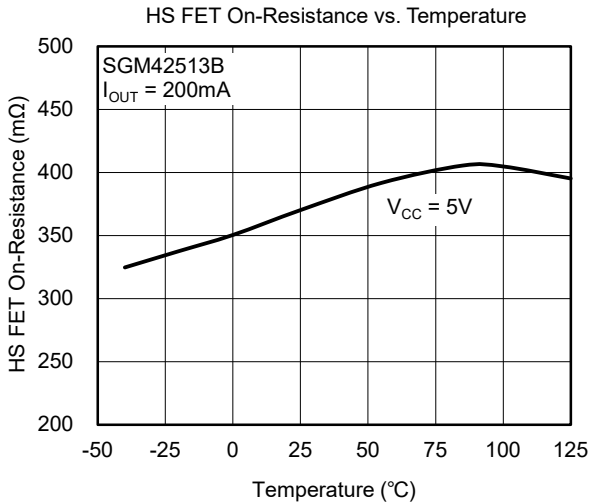
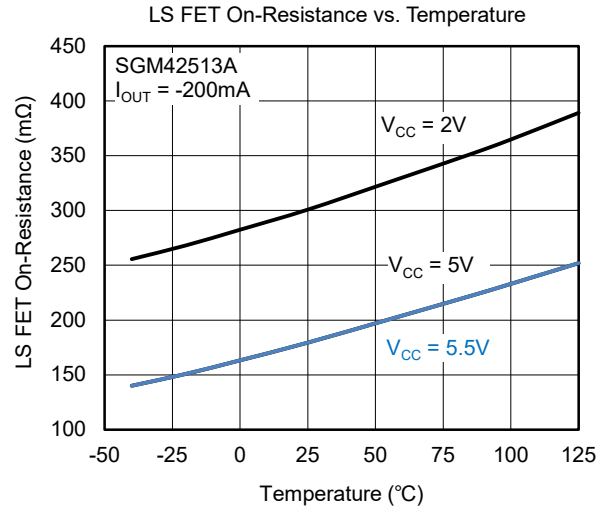
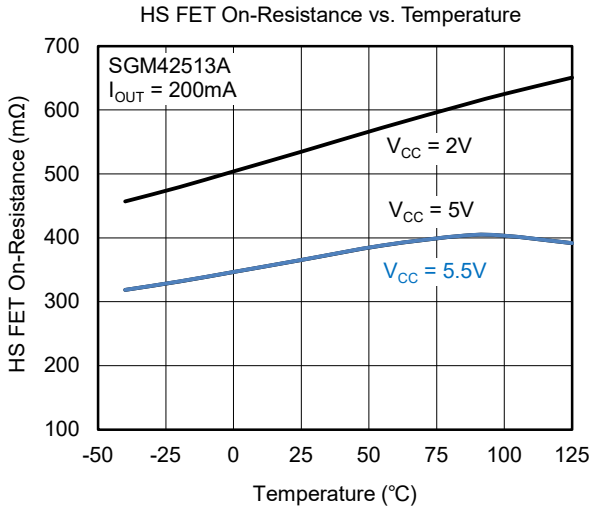

TYPICAL PERFORMANCE CHARACTERISTICS (continued)

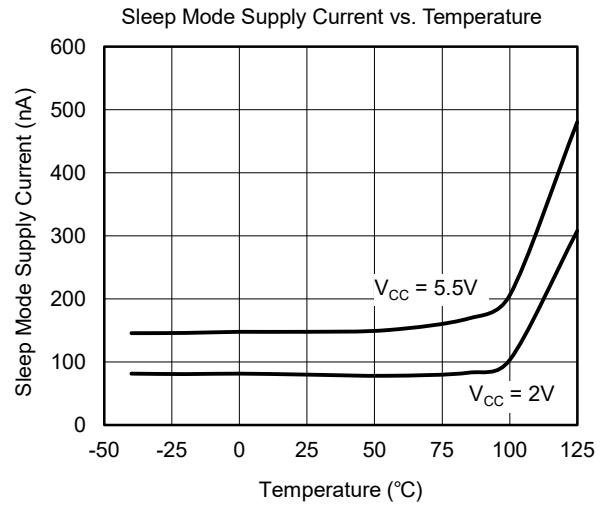
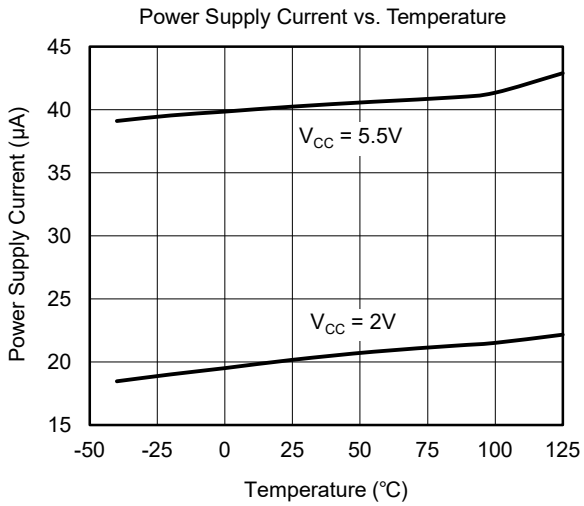
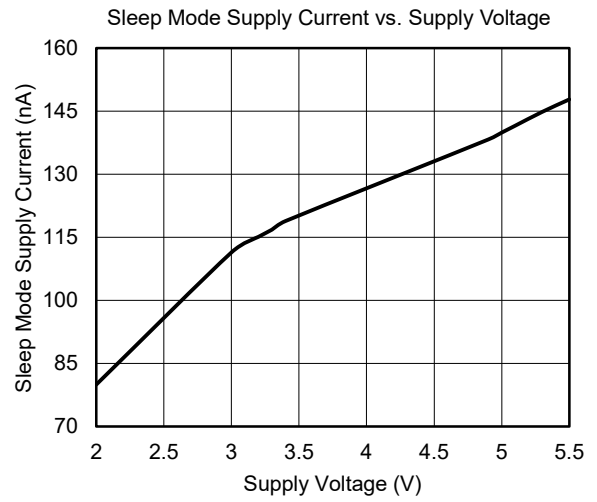
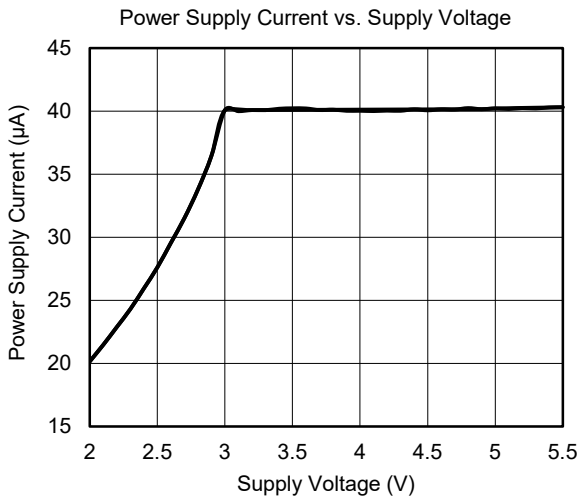

REVISION HISTORY

NOTE: Page numbers for previous revisions may differ from page numbers in the current version.

Changes from Original (DECEMBER 2018) to REV.A

Changed from product preview to production data.....All

PACKAGE INFORMATION

PACKAGE OUTLINE DIMENSIONS

TSOT-23-6

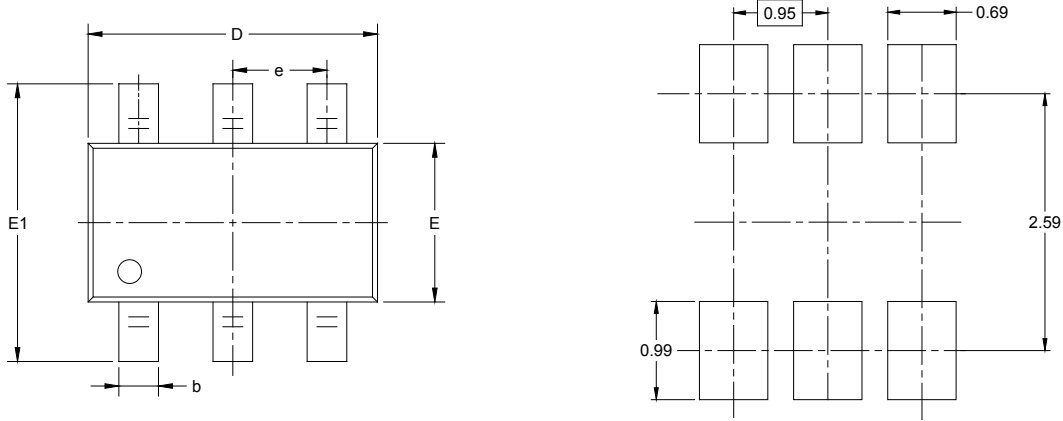

RECOMMENDED LAND PATTERN (Unit: mm)

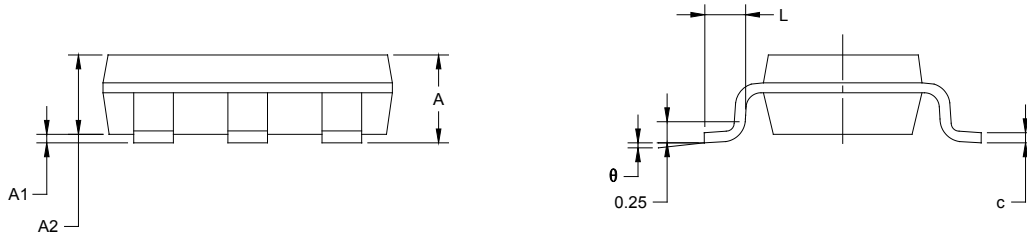

Symbol	Dimensions In Millimeters		Dimensions In Inches	
	MIN	MAX	MIN	MAX
A		1.000		0.043
A1	0.000	0.100	0.000	0.004
A2	0.700	0.900	0.028	0.039
b	0.300	0.500	0.012	0.020
c	0.080	0.200	0.003	0.008
D	2.850	2.950	0.112	0.116
E	1.550	1.650	0.061	0.065
E1	2.650	2.950	0.104	0.116
e	0.950 BSC		0.037 BSC	
L	0.300	0.600	0.012	0.024
θ	0°	8°	0°	8°

TAPE AND REEL INFORMATION

REEL DIMENSIONS

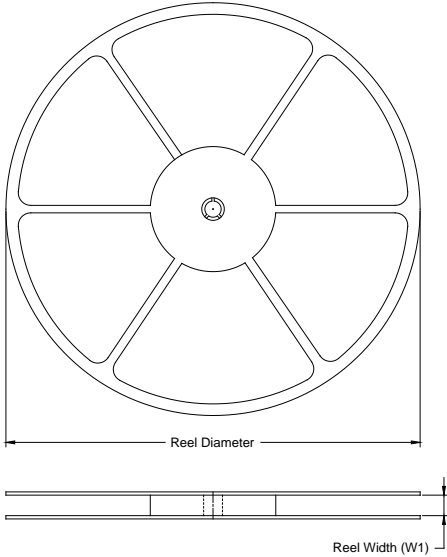

TAPE DIMENSIONS

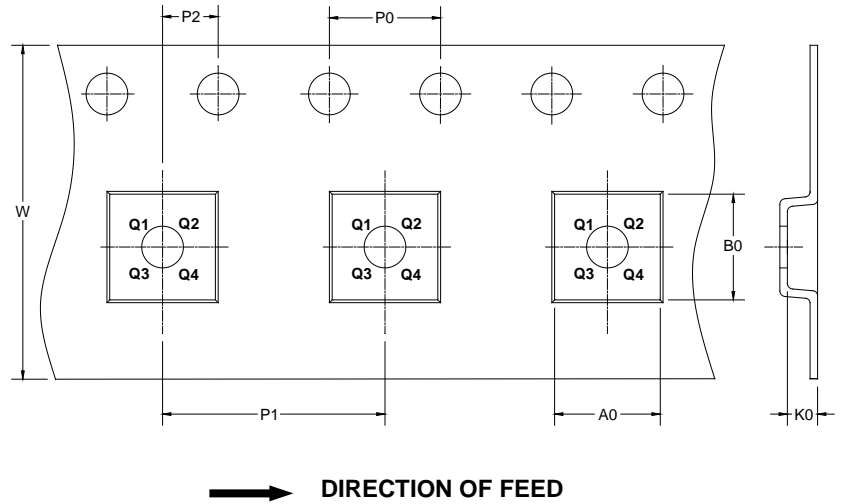

NOTE: The picture is only for reference. Please make the object as the standard.

KEY PARAMETER LIST OF TAPE AND REEL

Package Type	Reel Diameter	Reel Width W1 (mm)	A0 (mm)	B0 (mm)	K0 (mm)	P0 (mm)	P1 (mm)	P2 (mm)	W (mm)	Pin1 Quadrant
TSOT-23-6	7"	9.5	3.20	3.10	1.10	4.0	4.0	2.0	8.0	Q3

000001

PACKAGE INFORMATION

CARTON BOX DIMENSIONS



NOTE: The picture is only for reference. Please make the object as the standard.

KEY PARAMETER LIST OF CARTON BOX

Reel Type	Length (mm)	Width (mm)	Height (mm)	Pizza/Carton
7" (Option)	368	227	224	8
7"	442	410	224	18

DD0002