



SGM8704

Micro-Power, CMOS Input, RRIO, 1.4V, Push-Pull Output Comparator

GENERAL DESCRIPTION

The SGM8704 is a single, rail-to-rail input CMOS comparator with typical 300nA ultra-low power supply current. The comparator operates from a wide range of 1.4V to 5.5V supply voltage, and is guaranteed to operate at 1.4V, 2.5V and 5.0V. This feature is suitable for battery-powered applications.

The SGM8704 is optimized for micro-power, single-supply operation. The push-pull output stage supports rail-to-rail output swing and allows the operation with absolute minimum power consumption when driving any capacitive or resistive load. The SGM8704 also has a latch enable input pin (\overline{LE}) and complementary outputs.

The SGM8704 is available in Green SOIC-8 and MSOP-8 packages. It is rated over the -40°C to +85°C temperature range.

FEATURES

- **Ultra-Low Quiescent Current:**
300nA (TYP) at $V_S = 1.4V$
- V_{OUT} and $\overline{V_{OUT}}$ Dual Outputs
- **Wide Single-Supply Voltage Range: 1.4V to 5.5V**
- **Typical 6 μ s Propagation Delay at $V_S = 1.4V$**
- **Latch Function Included**
- **Rail-to-Rail Input and Output**
- **Push-Pull Output Current Drive:**
19mA (TYP) at $V_S = 5V$
- **-40°C to +85°C Operating Temperature Range**
- **Available in Green SOIC-8 and MSOP-8 Packages**

APPLICATIONS

Portable and Battery-Powered Applications
Alarm and Surveillance Circuits
Mobile Phones
RC Timers
Hand-Held Electronics
Window Detectors
IR Receiver

PACKAGE/ORDERING INFORMATION

MODEL	PACKAGE DESCRIPTION	SPECIFIED TEMPERATURE RANGE	ORDERING NUMBER	PACKAGE MARKING	PACKING OPTION
SGM8704	SOIC-8	-40°C to +85°C	SGM8704YS8G/TR	SGM8704YS8 XXXXX	Tape and Reel, 2500
	MSOP-8	-40°C to +85°C	SGM8704YMS8G/TR	SGM8704 YMS8 XXXXX	Tape and Reel, 3000

MARKING INFORMATION

NOTE: XXXXX = Date Code and Vendor Code.

SOIC-8/MSOP-8

XXXXX

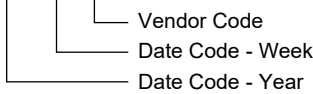

Green (RoHS & HSF): SG Micro Corp defines "Green" to mean Pb-Free (RoHS compatible) and free of halogen substances. If you have additional comments or questions, please contact your SGMICRO representative directly.

ABSOLUTE MAXIMUM RATINGS

- Supply Voltage, +V_S to -V_S 6V
- V_{IN} Differential ±2.5V
- Voltage at Input/Output Pins (-V_S) - 0.3V to (+V_S) + 0.3V
- Junction Temperature +150°C
- Storage Temperature Range -65°C to +150°C
- Lead Temperature (Soldering, 10s) +260°C
- ESD Susceptibility
- HBM 3000V
- MM 300V

RECOMMENDED OPERATING CONDITIONS

- Operating Temperature Range -40°C to +85°C

OVERSTRESS CAUTION

Stresses beyond those listed in Absolute Maximum Ratings may cause permanent damage to the device. Exposure to absolute maximum rating conditions for extended periods may affect reliability. Functional operation of the device at any conditions beyond those indicated in the Recommended Operating Conditions section is not implied.

ESD SENSITIVITY CAUTION

This integrated circuit can be damaged by ESD if you don't pay attention to ESD protection. SGMICRO recommends that all integrated circuits be handled with appropriate precautions. Failure to observe proper handling and installation procedures

can cause damage. ESD damage can range from subtle performance degradation to complete device failure. Precision integrated circuits may be more susceptible to damage because very small parametric changes could cause the device not to meet its published specifications.

DISCLAIMER

SG Micro Corp reserves the right to make any change in circuit design, or specifications without prior notice.

PIN CONFIGURATIONS

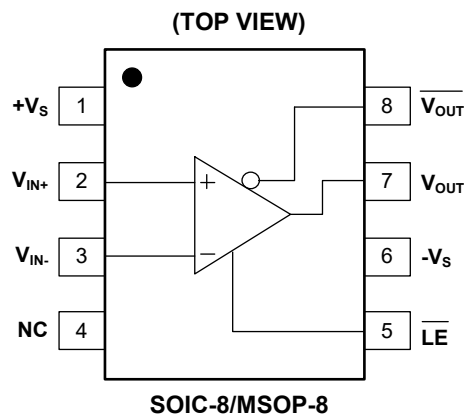

ELECTRICAL CHARACTERISTICS

(At $T_A = +25^\circ\text{C}$, $+V_S = 1.4\text{V}$, $-V_S = 0\text{V}$, $V_{\overline{\text{LE}}} = 1.4\text{V}$, $V_{\text{CM}} = +V_S/2$ and $V_{\text{OUT}} = -V_S$, unless otherwise noted.)

PARAMETER	SYMBOL	CONDITIONS		MIN	TYP	MAX	UNITS
Supply Current	I_S	$V_{\text{CM}} = 0.3\text{V}$			300	1000	nA
		$V_{\text{CM}} = 1.1\text{V}$			250	1000	
Input Offset Voltage	V_{OS}	$V_{\text{CM}} = 0\text{V}$		-3	0.5	3	mV
		$V_{\text{CM}} = 1.4\text{V}$		-3	0.5	3	
Input Offset Average Drift					2		$\mu\text{V}/^\circ\text{C}$
Common Mode Rejection Ratio	CMRR	V_{CM} Stepped from 0V to 0.3V			65		dB
		V_{CM} Stepped from 0.8V to 1.4V			75		
		V_{CM} Stepped from 0V to 1.4V			75		
Power Supply Rejection Ratio	PSRR			66	95		dB
Latch Enable Pin High Input Voltage	V_{IH}			1.0			V
Latch Enable Pin Low Input Voltage	V_{IL}					0.25	V
Latch Enable Pin Bias Current	$I_{\text{IH}}, I_{\text{IL}}$	$V_{\overline{\text{LE}}} = 0\text{V}$ and $V_{\overline{\text{LE}}} = 1.4\text{V}$			3		nA
Large Signal Voltage Gain	A_{VO}				100		dB
Output Swing High	V_{OH}	$V_{\text{OUT}}, \overline{V_{\text{OUT}}}$	$V_S = 1.8\text{V}, I_{\text{OUT}} = 500\mu\text{A}$	1.598	1.669		V
			$-40^\circ\text{C} \leq T_A \leq +85^\circ\text{C}$	1.581			
			$V_S = 1.8\text{V}, I_{\text{OUT}} = 1\text{mA}$	1.324	1.508		
			$-40^\circ\text{C} \leq T_A \leq +85^\circ\text{C}$	1.288			
Output Swing Low	V_{OL}	$V_{\text{OUT}}, \overline{V_{\text{OUT}}}$	$V_S = 1.8\text{V}, I_{\text{OUT}} = -500\mu\text{A}$		82	112	mV
			$-40^\circ\text{C} \leq T_A \leq +85^\circ\text{C}$			127	
			$V_S = 1.8\text{V}, I_{\text{OUT}} = -1\text{mA}$		167	225	
			$-40^\circ\text{C} \leq T_A \leq +85^\circ\text{C}$			253	
Output Current	I_{OUT}	Source	$V_{\text{OUT}}, \overline{V_{\text{OUT}}}$		0.7		mA
		Sink	$V_{\text{OUT}}, \overline{V_{\text{OUT}}}$		2.0		
Propagation Delay (High to Low)		$V_{\text{OUT}}, \overline{V_{\text{OUT}}}$	Overdrive = 10mV		12		μs
			Overdrive = 100mV		6		
Propagation Delay (Low to High)		$V_{\text{OUT}}, \overline{V_{\text{OUT}}}$	Overdrive = 10mV		26		μs
			Overdrive = 100mV		17		
Rise Time	t_{Rise}	$V_{\text{OUT}}, \overline{V_{\text{OUT}}}$	Overdrive = 10mV, $C_L = 30\text{pF}, R_L = 1\text{M}\Omega$		220		ns
			Overdrive = 100mV, $C_L = 30\text{pF}, R_L = 1\text{M}\Omega$		220		
Fall Time	t_{Fall}	$V_{\text{OUT}}, \overline{V_{\text{OUT}}}$	Overdrive = 10mV, $C_L = 30\text{pF}, R_L = 1\text{M}\Omega$		250		ns
			Overdrive = 100mV, $C_L = 30\text{pF}, R_L = 1\text{M}\Omega$		250		

ELECTRICAL CHARACTERISTICS (continued)(At $T_A = +25^\circ\text{C}$, $+V_S = 2.5\text{V}$, $-V_S = 0\text{V}$, $V_{\overline{\text{LE}}} = 2.5\text{V}$, $V_{\text{CM}} = +V_S/2$ and $V_{\text{OUT}} = -V_S$, unless otherwise noted.)

PARAMETER	SYMBOL	CONDITIONS		MIN	TYP	MAX	UNITS
Supply Current	I_S	$V_{\text{CM}} = 0.3\text{V}$			310		nA
		$V_{\text{CM}} = 2.2\text{V}$			260		
Input Offset Voltage	V_{OS}	$V_{\text{CM}} = 0\text{V}$			0.5		mV
		$V_{\text{CM}} = 2.5\text{V}$			0.5		
Input Offset Average Drift		$V_{\text{CM}} = 0\text{V}$			2		$\mu\text{V}/^\circ\text{C}$
Common Mode Rejection Ratio	CMRR	V_{CM} Stepped from 0V to 1.4V			75		dB
		V_{CM} Stepped from 1.9V to 2.5V			80		
		V_{CM} Stepped from 0V to 2.5V			80		
Power Supply Rejection Ratio	PSRR				95		dB
Latch Enable Pin High Input Voltage	V_{IH}			1.2			V
Latch Enable Pin Low Input Voltage	V_{IL}					0.4	V
Latch Enable Pin Bias Current	$I_{\text{IH}}, I_{\text{IL}}$	$V_{\overline{\text{LE}}} = 0\text{V}$ and $V_{\overline{\text{LE}}} = 2.5\text{V}$			15		nA
Large Signal Voltage Gain	A_{VO}				100		dB
Output Swing High	V_{OH}	$V_{\text{OUT}}, \overline{V_{\text{OUT}}}$	$I_{\text{OUT}} = 500\mu\text{A}$		2.419		V
			$I_{\text{OUT}} = 1\text{mA}$		2.333		
Output Swing Low	V_{OL}	$V_{\text{OUT}}, \overline{V_{\text{OUT}}}$	$I_{\text{OUT}} = -500\mu\text{A}$		66		mV
			$I_{\text{OUT}} = -1\text{mA}$		133		
Output Current	I_{OUT}	Source	$V_{\text{OUT}}, \overline{V_{\text{OUT}}}$		5.3		mA
		Sink	$V_{\text{OUT}}, \overline{V_{\text{OUT}}}$		7.7		
Propagation Delay (High to Low)		$V_{\text{OUT}}, \overline{V_{\text{OUT}}}$	Overdrive = 10mV		12		μs
			Overdrive = 100mV		5		
Propagation Delay (Low to High)		$V_{\text{OUT}}, \overline{V_{\text{OUT}}}$	Overdrive = 10mV		28		μs
			Overdrive = 100mV		19		
Rise Time	t_{Rise}	$V_{\text{OUT}}, \overline{V_{\text{OUT}}}$	Overdrive = 10mV, $C_L = 30\text{pF}$, $R_L = 1\text{M}\Omega$		120		ns
			Overdrive = 100mV, $C_L = 30\text{pF}$, $R_L = 1\text{M}\Omega$		120		
Fall Time	t_{Fall}	$V_{\text{OUT}}, \overline{V_{\text{OUT}}}$	Overdrive = 10mV, $C_L = 30\text{pF}$, $R_L = 1\text{M}\Omega$		75		ns
			Overdrive = 100mV, $C_L = 30\text{pF}$, $R_L = 1\text{M}\Omega$		75		

ELECTRICAL CHARACTERISTICS (continued)(At $T_A = +25^\circ\text{C}$, $+V_S = 5\text{V}$, $-V_S = 0\text{V}$, $V_{\overline{\text{LE}}} = 5\text{V}$, $V_{\text{CM}} = +V_S/2$ and $V_{\text{OUT}} = -V_S$, unless otherwise noted.)

PARAMETER	SYMBOL	CONDITIONS		MIN	TYP	MAX	UNITS
Supply Current	I_S	$V_{\text{CM}} = 0.3\text{V}$			350	2000	nA
		$V_{\text{CM}} = 4.7\text{V}$			300	2000	
Input Offset Voltage	V_{OS}	$V_{\text{CM}} = 0\text{V}$		-3	0.5	3	mV
		$V_{\text{CM}} = 5\text{V}$		-3	0.5	3	
Input Offset Average Drift		$V_{\text{CM}} = 0\text{V}$			2		$\mu\text{V}/^\circ\text{C}$
Common Mode Rejection Ratio	CMRR	V_{CM} Stepped from 0V to 3.9V			85		dB
		V_{CM} Stepped from 4.4V to 5V			85		
		V_{CM} Stepped from 0V to 5V			85		
Power Supply Rejection Ratio	PSRR			66	95		dB
Latch Enable Pin High Input Voltage	V_{IH}			2.0			V
Latch Enable Pin Low Input Voltage	V_{IL}					0.8	V
Latch Enable Pin Bias Current	$I_{\text{IH}}, I_{\text{IL}}$	$V_{\overline{\text{LE}}} = 0\text{V}$ and $V_{\overline{\text{LE}}} = 5\text{V}$			60		nA
Latch Propagation Delay	t_{LPD}	$V_S = 3\text{V}$			90		ns
Large Signal Voltage Gain	A_{VO}				105		dB
Output Swing High	V_{OH}	$V_{\text{OUT}}, \overline{V_{\text{OUT}}}$	$I_{\text{OUT}} = 500\mu\text{A}$	4.923	4.952		V
			$-40^\circ\text{C} \leq T_A \leq +85^\circ\text{C}$	4.916			
			$I_{\text{OUT}} = 1\text{mA}$	4.864	4.904		
			$-40^\circ\text{C} \leq T_A \leq +85^\circ\text{C}$	4.848			
Output Swing Low	V_{OL}	$V_{\text{OUT}}, \overline{V_{\text{OUT}}}$	$I_{\text{OUT}} = -500\mu\text{A}$		52	80	mV
			$-40^\circ\text{C} \leq T_A \leq +85^\circ\text{C}$			90	
			$I_{\text{OUT}} = -1\text{mA}$		104	131	
			$-40^\circ\text{C} \leq T_A \leq +85^\circ\text{C}$			143	
Output Current	I_{OUT}	Source	$V_{\text{OUT}}, \overline{V_{\text{OUT}}}$	14	18		mA
			$-40^\circ\text{C} \leq T_A \leq +85^\circ\text{C}$	12			
		Sink	$V_{\text{OUT}}, \overline{V_{\text{OUT}}}$	15	19		
			$-40^\circ\text{C} \leq T_A \leq +85^\circ\text{C}$	12.9			
Propagation Delay (High to Low)		$V_{\text{OUT}}, \overline{V_{\text{OUT}}}$	Overdrive = 10mV		13		μs
			Overdrive = 100mV		6		
Propagation Delay (Low to High)		$V_{\text{OUT}}, \overline{V_{\text{OUT}}}$	Overdrive = 10mV		42		μs
			Overdrive = 100mV		33		
Rise Time	t_{Rise}	$V_{\text{OUT}}, \overline{V_{\text{OUT}}}$	Overdrive = 10mV, $C_L = 30\text{pF}$, $R_L = 1\text{M}\Omega$		85		ns
			Overdrive = 100mV, $C_L = 30\text{pF}$, $R_L = 1\text{M}\Omega$		85		
Fall Time	t_{Fall}	$V_{\text{OUT}}, \overline{V_{\text{OUT}}}$	Overdrive = 10mV, $C_L = 30\text{pF}$, $R_L = 1\text{M}\Omega$		70		ns
			Overdrive = 100mV, $C_L = 30\text{pF}$, $R_L = 1\text{M}\Omega$		60		

TYPICAL PERFORMANCE CHARACTERISTICS

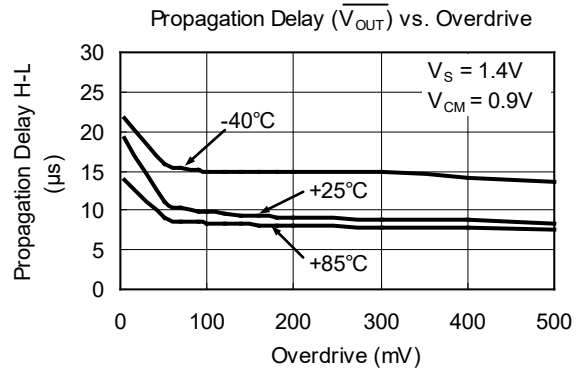
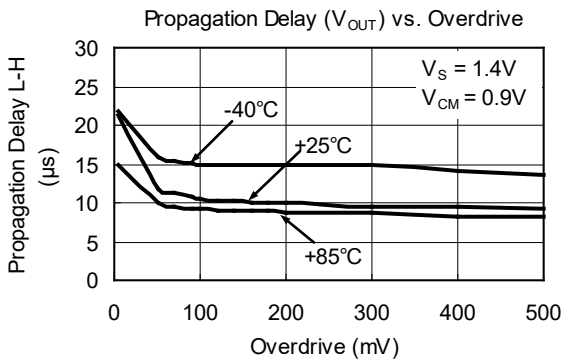
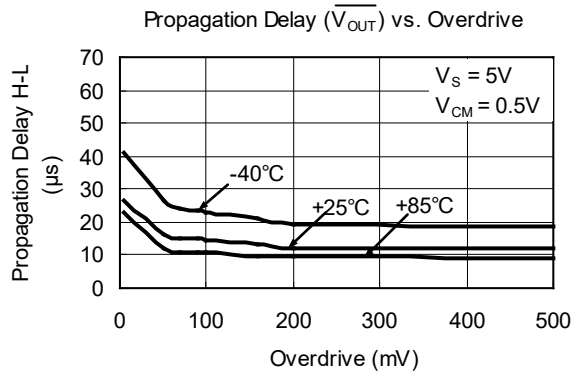
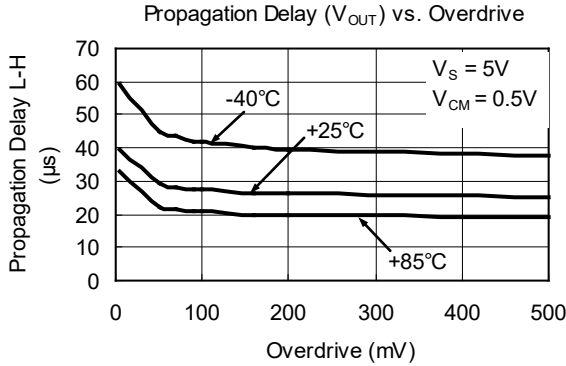
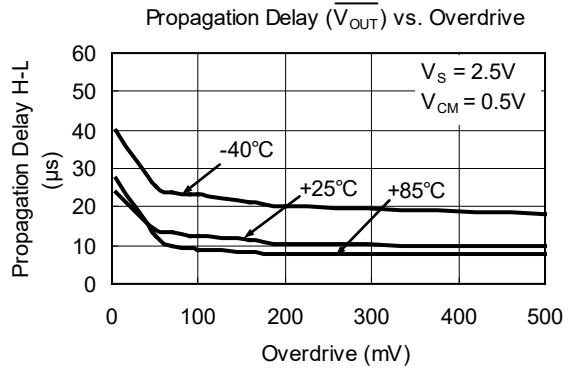
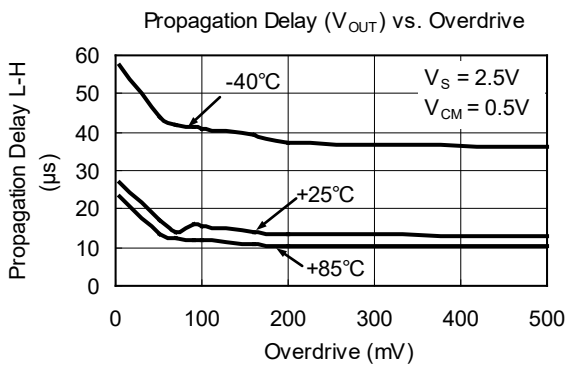
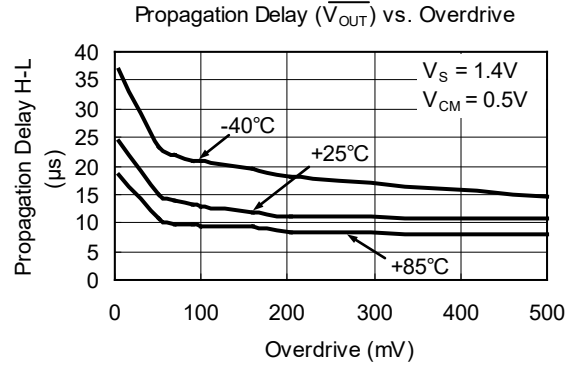
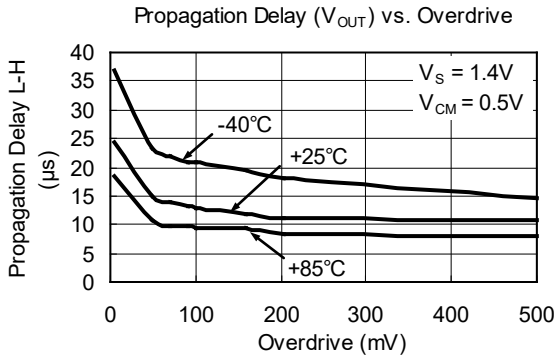

TYPICAL PERFORMANCE CHARACTERISTICS (continued)

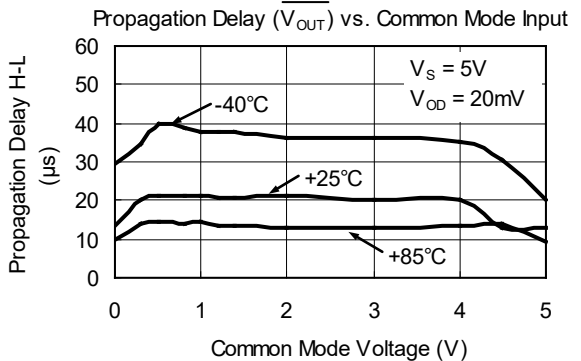
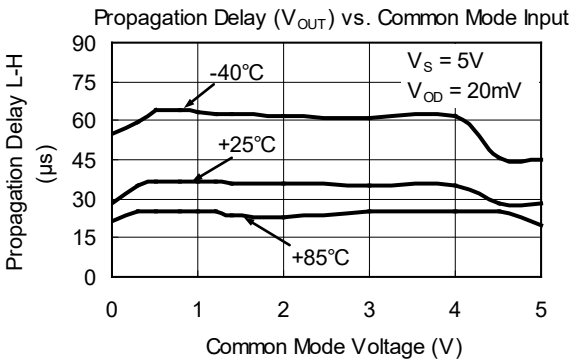
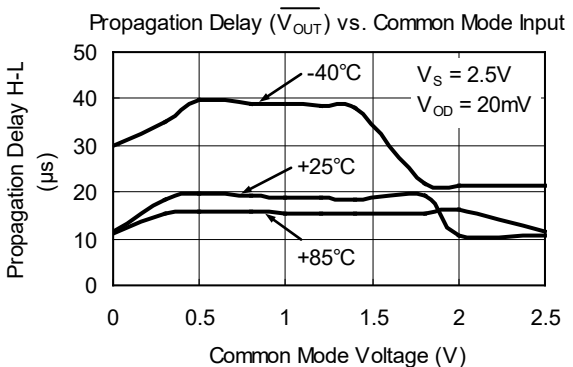
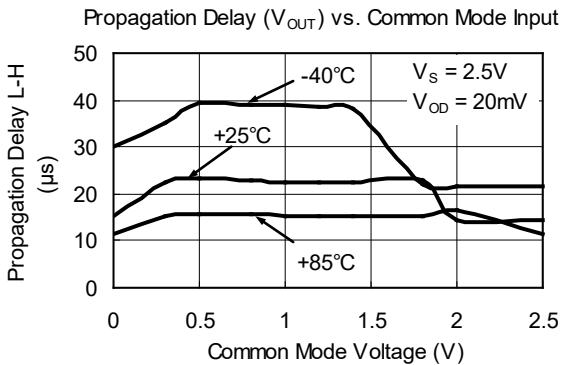
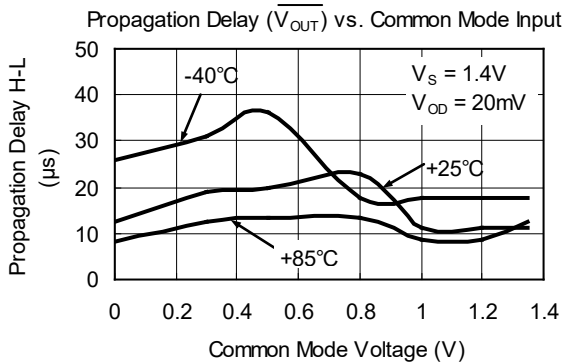
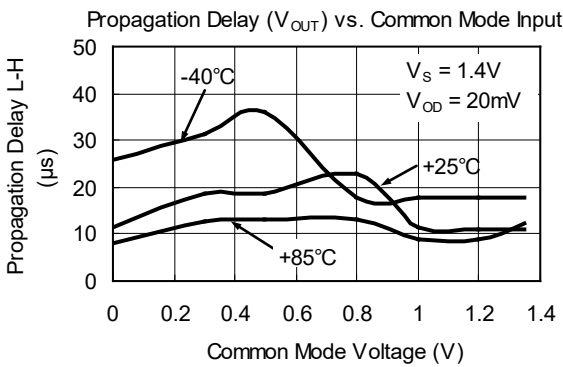
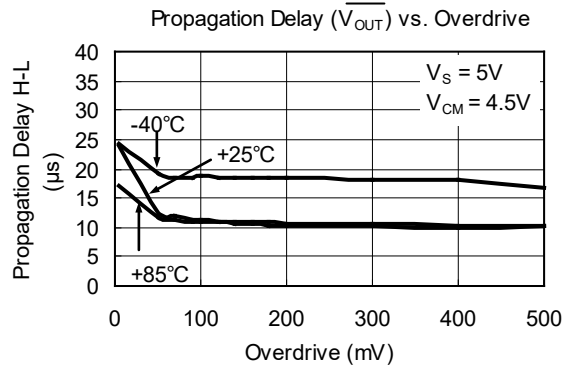
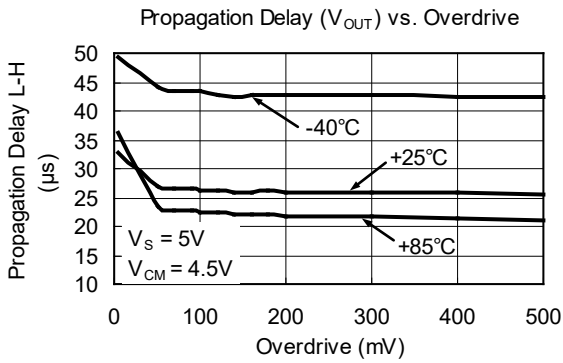

TYPICAL PERFORMANCE CHARACTERISTICS (continued)

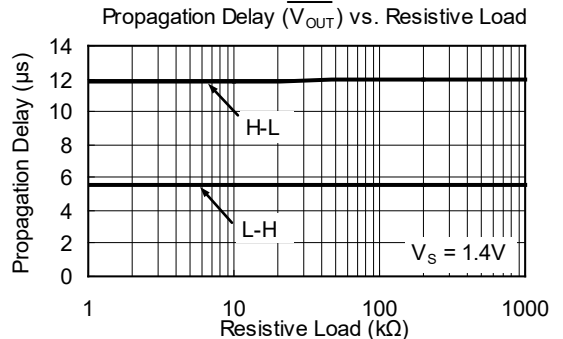
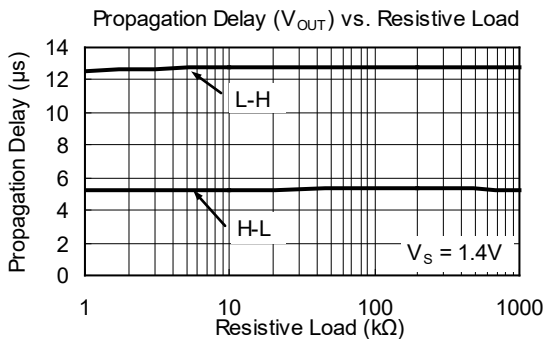
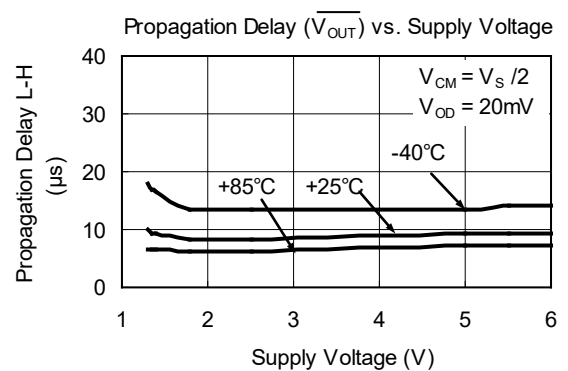
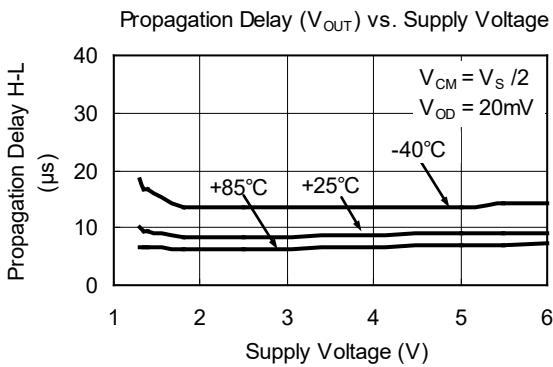
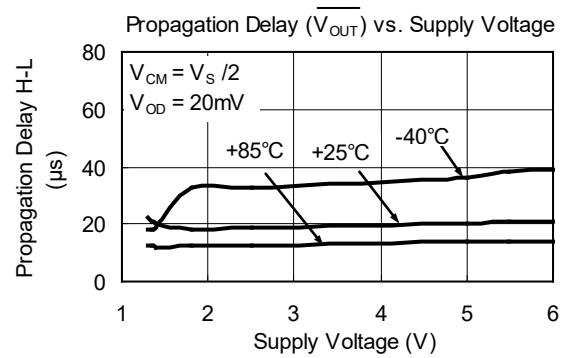
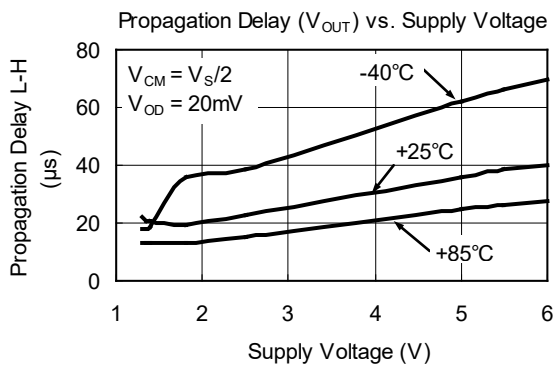
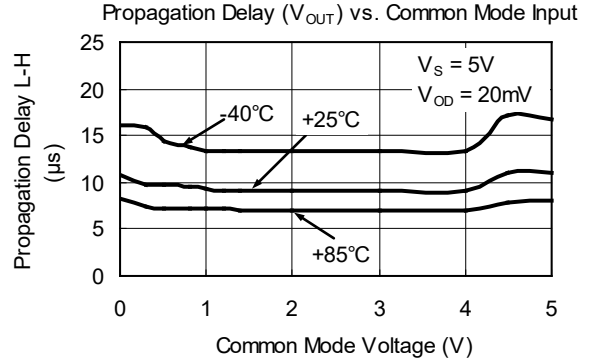
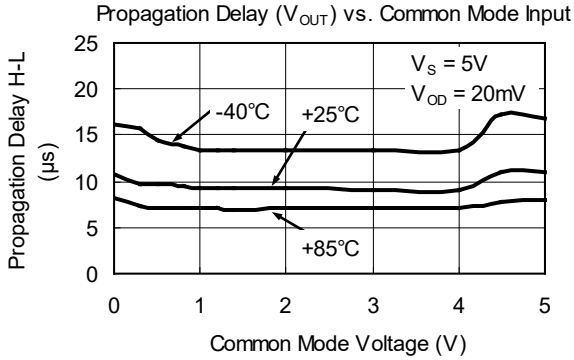

TYPICAL PERFORMANCE CHARACTERISTICS (continued)

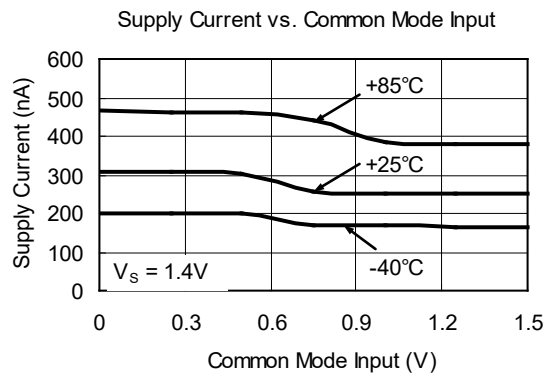
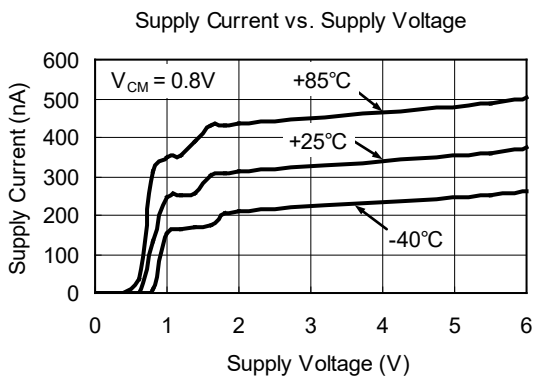
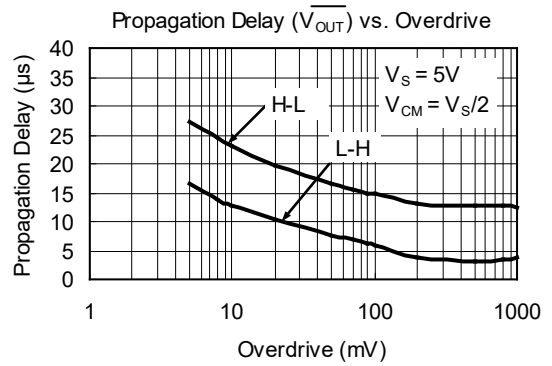
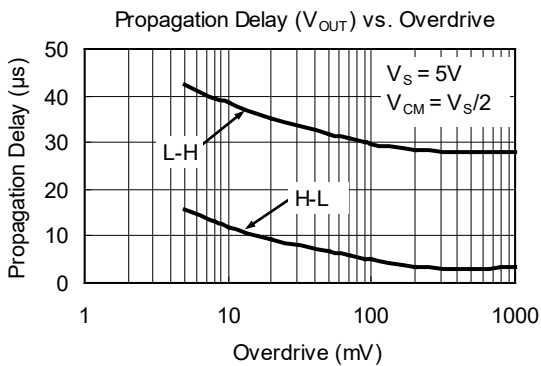
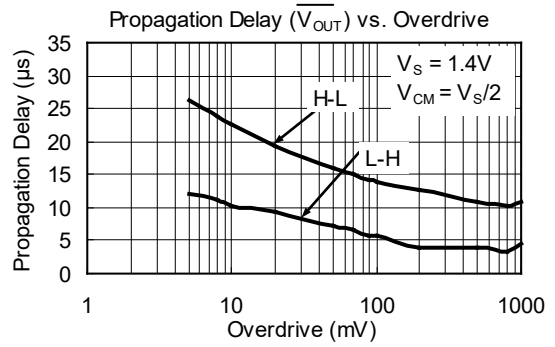
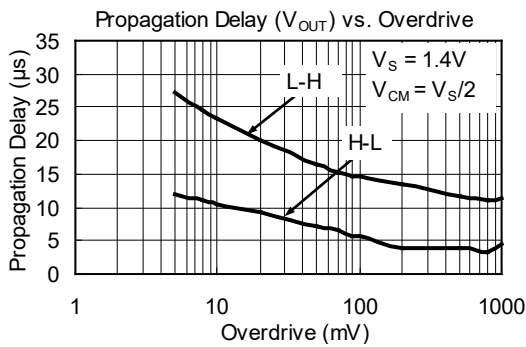
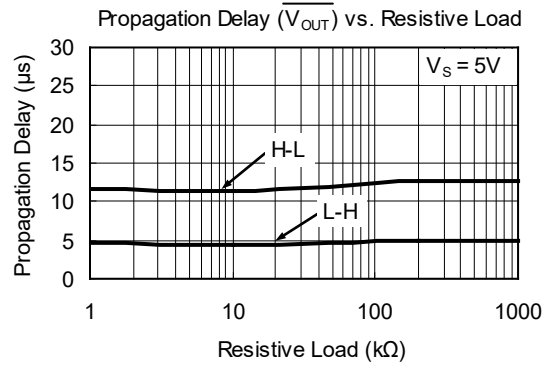
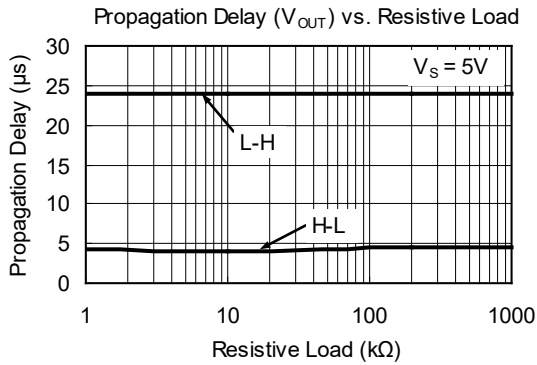

TYPICAL PERFORMANCE CHARACTERISTICS (continued)

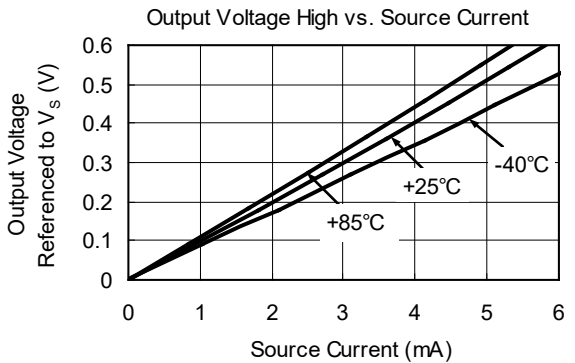
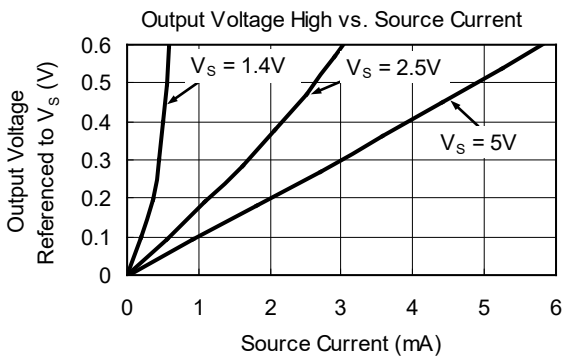
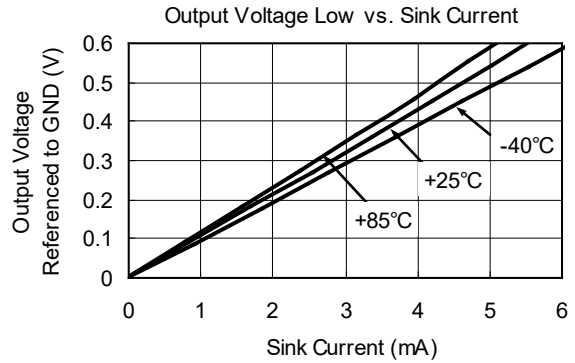
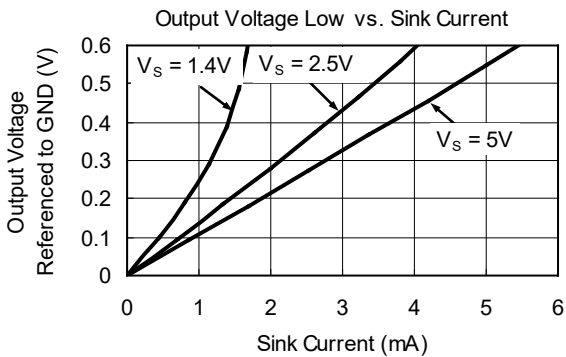
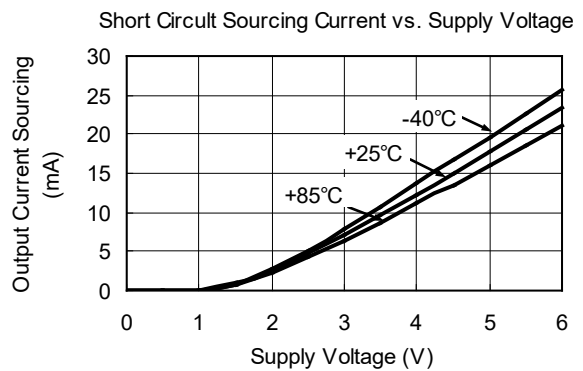
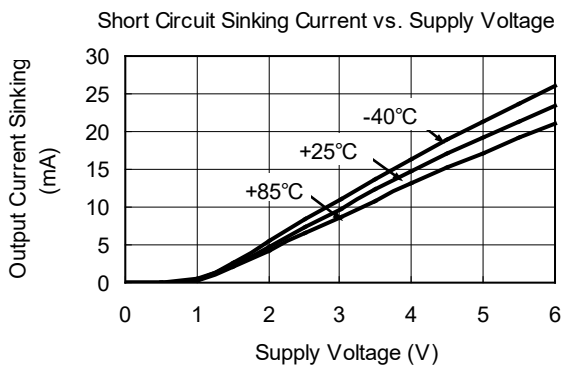
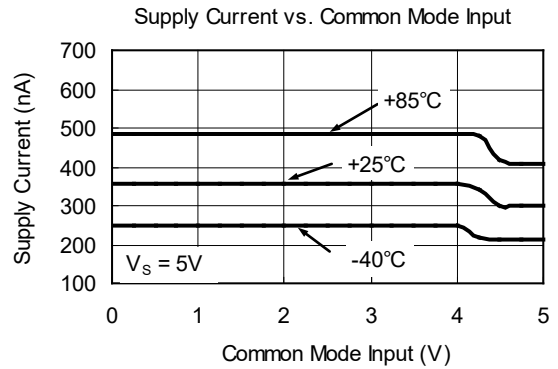
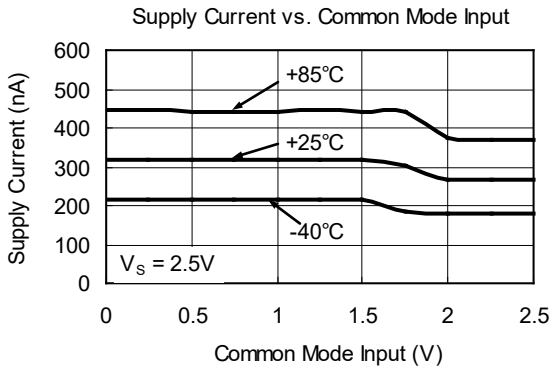

TYPICAL PERFORMANCE CHARACTERISTICS (continued)

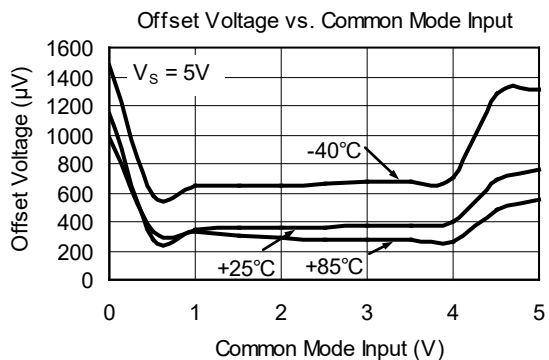

TIMING DIAGRAM

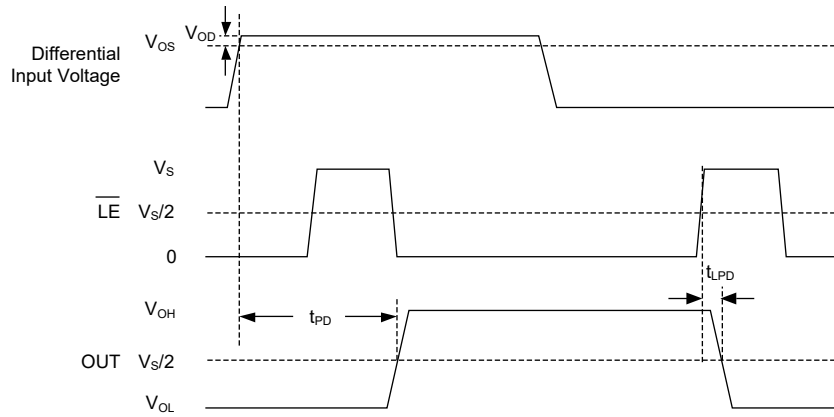

Figure 1. Timing Diagram with Latch Operator

REVISION HISTORY

NOTE: Page numbers for previous revisions may differ from page numbers in the current version.

DECEMBER 2013 – REV.A.1 to REV.A.2	Page
Changed Electrical Characteristics section.....	4
Added Electrical Characteristics section.....	5
Added Timing Diagram section	13
JUANUARY 2013 – REV.A to REV.A.1	Page
Added Tape and Reel Information section.....	15, 16
Changes from Original (DECEMBER 2011) to REV.A	Page
Changed from product preview to production data.....	All

PACKAGE OUTLINE DIMENSIONS

SOIC-8

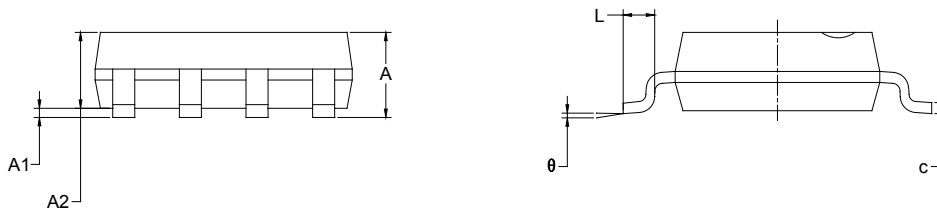
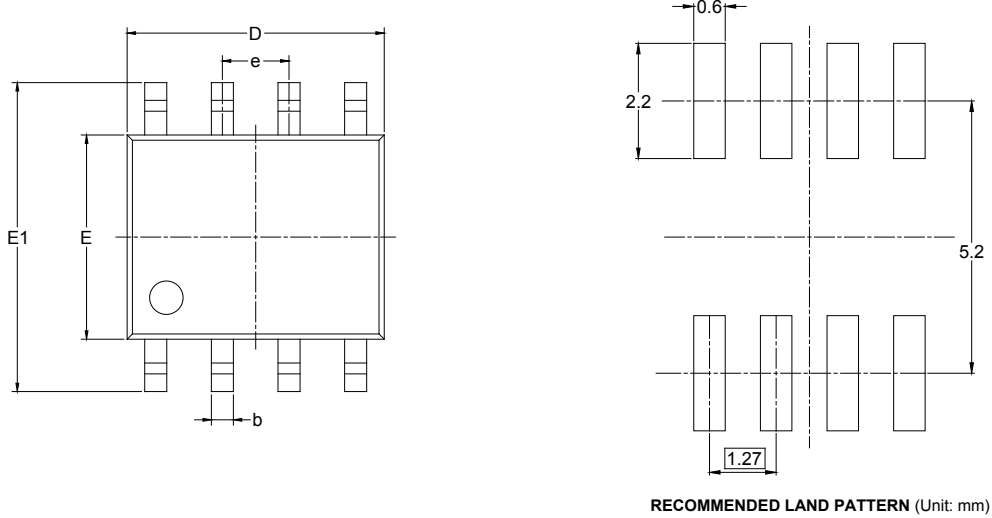

Symbol	Dimensions In Millimeters		Dimensions In Inches	
	MIN	MAX	MIN	MAX
A	1.350	1.750	0.053	0.069
A1	0.100	0.250	0.004	0.010
A2	1.350	1.550	0.053	0.061
b	0.330	0.510	0.013	0.020
c	0.170	0.250	0.006	0.010
D	4.700	5.100	0.185	0.200
E	3.800	4.000	0.150	0.157
E1	5.800	6.200	0.228	0.244
e	1.27 BSC		0.050 BSC	
L	0.400	1.270	0.016	0.050
θ	0°	8°	0°	8°

PACKAGE OUTLINE DIMENSIONS

MSOP-8

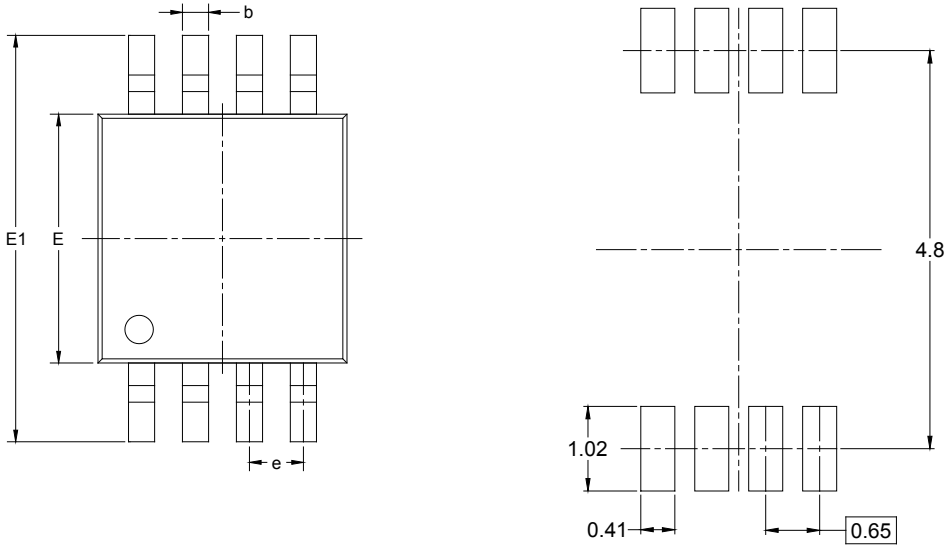

RECOMMENDED LAND PATTERN (Unit: mm)

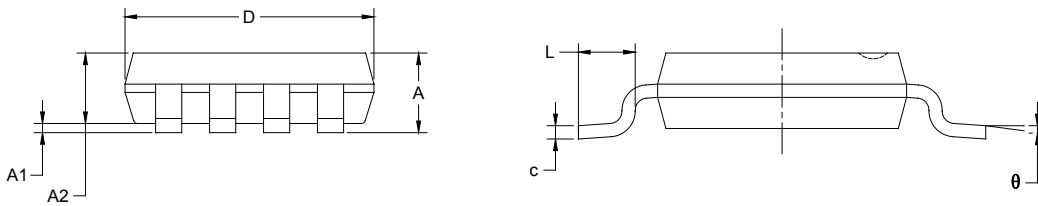

Symbol	Dimensions In Millimeters		Dimensions In Inches	
	MIN	MAX	MIN	MAX
A	0.820	1.100	0.032	0.043
A1	0.020	0.150	0.001	0.006
A2	0.750	0.950	0.030	0.037
b	0.250	0.380	0.010	0.015
c	0.090	0.230	0.004	0.009
D	2.900	3.100	0.114	0.122
E	2.900	3.100	0.114	0.122
E1	4.750	5.050	0.187	0.199
e	0.650 BSC		0.026 BSC	
L	0.400	0.800	0.016	0.031
θ	0°	6°	0°	6°

TAPE AND REEL INFORMATION

REEL DIMENSIONS

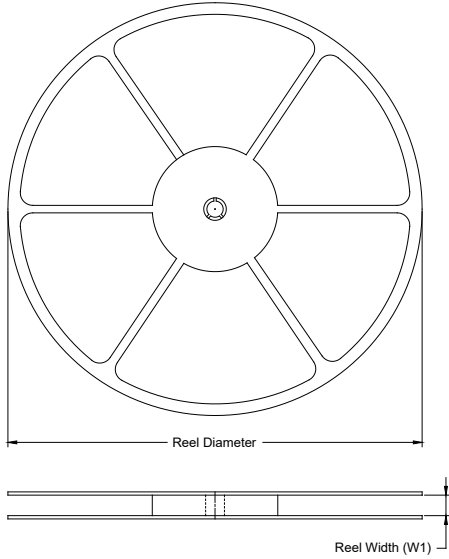

TAPE DIMENSIONS

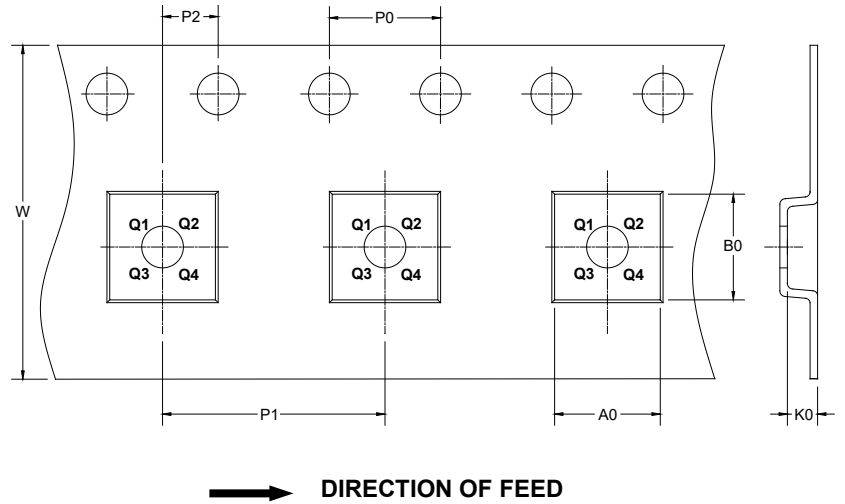

NOTE: The picture is only for reference. Please make the object as the standard.

KEY PARAMETER LIST OF TAPE AND REEL

Package Type	Reel Diameter	Reel Width W1 (mm)	A0 (mm)	B0 (mm)	K0 (mm)	P0 (mm)	P1 (mm)	P2 (mm)	W (mm)	Pin1 Quadrant
SOIC-8	13"	12.4	6.40	5.40	2.10	4.0	8.0	2.0	12.0	Q1
MSOP-8	13"	12.4	5.20	3.30	1.50	4.0	8.0	2.0	12.0	Q1

DD0001

PACKAGE INFORMATION

CARTON BOX DIMENSIONS

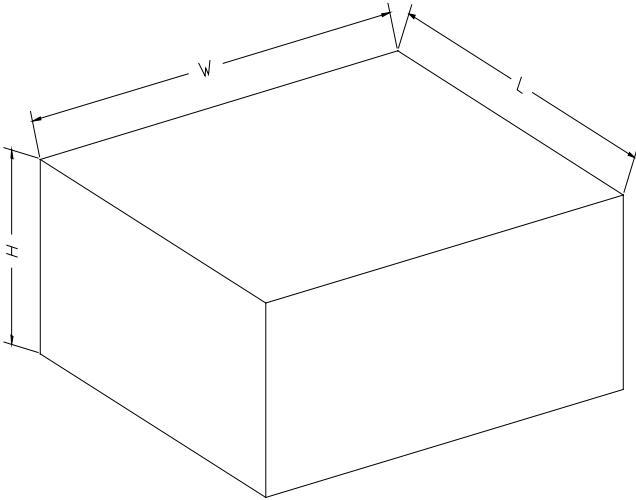

NOTE: The picture is only for reference. Please make the object as the standard.

KEY PARAMETER LIST OF CARTON BOX

Reel Type	Length (mm)	Width (mm)	Height (mm)	Pizza/Carton
13"	386	280	370	5

DD0002