

### GENERAL DESCRIPTION

The SGM6033 is a high-efficient Buck switching voltage regulator, supporting up to 1A output current and adjustable output voltage. This device is capable for an input voltage supply range of 2.5V to 5.5V. The 4.6MHz PWM mode frequency operation allows the use of a 470nH output inductor and a 4.7μF output capacitor.

The SGM6033 operates in power-save mode under moderate and light load conditions through pulse frequency modulation (PFM). The 26μA typical quiescent current and the power-save mode can further improve the system efficiency which can reach a maximum of 90%. The SGM6033 has excellent load transient response capability. The SGM6033 also includes features of internal soft-start, input under-voltage lockout, thermal shutdown and overload protection.

The SGM6033 is available in Green TDFN-2x2-6L and WLCSP-1.21x0.81-6B packages. It operates over an ambient temperature range of -40°C to +125°C.

### FEATURES

- 2.5V to 5.5V Input Voltage Range
- 1A Output Current Capability
- 26μA Typical Quiescent Current
- 4.6MHz Fixed Frequency Operation
- Excellent Efficiency and Load Transient Response
- 0.8V Reference Voltage
- Low Ripple Light-Load PFM Mode
- Internal Soft-Start
- Input Under-Voltage Lockout (UVLO)
- Thermal Shutdown
- Overload Protection
- Output Discharge
- Available in Green TDFN-2x2-6L and WLCSP-1.21x0.81-6B Packages
- -40°C to +125°C Operating Temperature Range

### APPLICATIONS

Digital Cameras  
 4G, WiFi, WiMasX, and WiBro Data Cards  
 Tablet Computers  
 Netbooks, Ultra-Mobile PCs

### TYPICAL APPLICATION

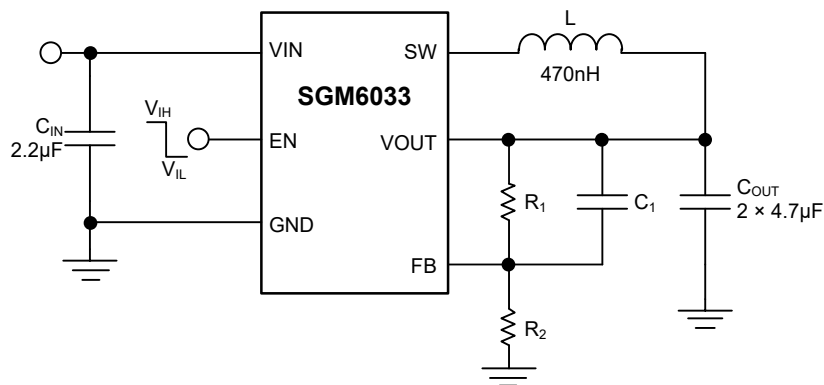

Figure 1. Typical Application Circuit

**PACKAGE/ORDERING INFORMATION**

MODEL	PACKAGE DESCRIPTION	SPECIFIED TEMPERATURE RANGE	ORDERING NUMBER	PACKAGE MARKING	PACKING OPTION
SGM6033-ADJ	TDFN-2x2-6L	-40°C to +125°C	SGM6033-ADJXTDI6G/TR	MX1 XXXX	Tape and Reel, 3000
	WLCSP-1.21x0.81-6B	-40°C to +125°C	SGM6033-ADJXG/TR	X2XX	Tape and Reel, 3000

**MARKING INFORMATION**

NOTE: XXXX = Date Code. XX = Date Code.

**TDFN-2x2-6L**

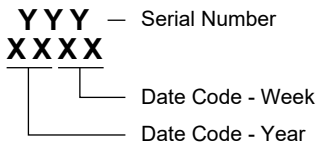

**WLCSP-1.21x0.81-6B**

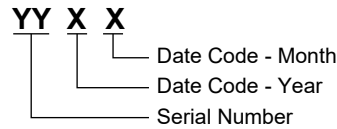

Green (RoHS & HSF): SG Micro Corp defines "Green" to mean Pb-Free (RoHS compatible) and free of halogen substances. If you have additional comments or questions, please contact your SGMICRO representative directly.

**ABSOLUTE MAXIMUM RATINGS**

- Input Voltage..... -0.3V to 6.5V
- Voltage on SW and EN..... -0.3V to  $V_{IN} + 0.3V$  <sup>(1)</sup>
- Package Thermal Resistance
- TDFN-2x2-6L,  $\theta_{JA}$ ..... 120°C/W
- WLCSP-1.21x0.81-6B,  $\theta_{JA}$ ..... 150°C/W
- Junction Temperature..... +150°C
- Storage Temperature Range..... -65°C to +150°C
- Lead Temperature (Soldering, 10s)..... +260°C
- ESD Susceptibility
- HBM..... 4000V
- MM..... 400V
- CDM..... 1000V

NOTE: 1. Lesser of 6.5V or  $V_{IN} + 0.3V$ .

**RECOMMENDED OPERATING CONDITIONS**

- Inductor, L..... 470nH
- Input Capacitor,  $C_{IN}$ ..... 2.2 $\mu$ F
- Output Capacitor,  $C_{OUT}$ ..... 2 x 4.7 $\mu$ F
- Supply Voltage Range..... 2.5V to 5.5V
- Operating Temperature Range..... -40°C to +125°C

**OVERSTRESS CAUTION**

Stresses beyond those listed in Absolute Maximum Ratings may cause permanent damage to the device. Exposure to absolute maximum rating conditions for extended periods may affect reliability. Functional operation of the device at any conditions beyond those indicated in the Recommended Operating Conditions section is not implied.

**ESD SENSITIVITY CAUTION**

This integrated circuit can be damaged if ESD protections are not considered carefully. SGMICRO recommends that all integrated circuits be handled with appropriate precautions. Failure to observe proper handling and installation procedures can cause damage. ESD damage can range from subtle performance degradation to complete device failure. Precision integrated circuits may be more susceptible to damage because even small parametric changes could cause the device not to meet the published specifications.

**DISCLAIMER**

SG Micro Corp reserves the right to make any change in circuit design, or specifications without prior notice.

**PIN CONFIGURATIONS**

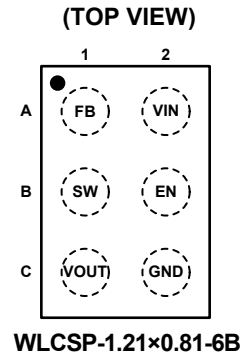
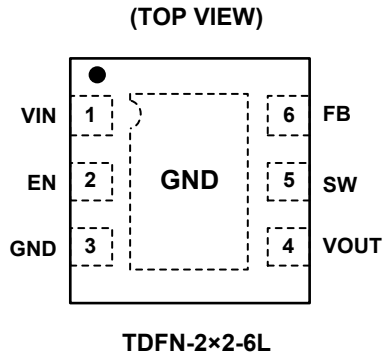

**PIN DESCRIPTION**

PIN		NAME	FUNCTION
TDFN-2x2-6L	WLCSP-1.21x0.81-6B		
1	A2	VIN	Input Voltage. Connect to input power source.
2	B2	EN	Forcing this pin above 1.5V enables the part. Forcing this pin below 0.3V shuts down the device. In shutdown, all functions are disabled, drawing less than 1µA supply current. Do not leave EN floating.
3	C2	GND	Ground. Power and IC ground. All signals are referenced to this pin.
4	C1	VOUT	V <sub>OUT</sub> . Connect to output voltage.
5	B1	SW	Switching Node. Connect to output inductor.
6	A1	FB	Buck Regulator Output Feedback Pin.
Exposed Pad	–	GND	Connect to GND.

**ELECTRICAL CHARACTERISTICS**

(Minimum and maximum values are at  $V_{IN} = V_{EN} = 2.5V$  to  $5.5V$ , Full =  $-40^{\circ}C$  to  $+125^{\circ}C$ ; typical values are at  $V_{IN} = V_{EN} = 3.6V$ ,  $T_A = +25^{\circ}C$ , unless otherwise noted.)

PARAMETER	SYMBOL	CONDITIONS	TEMP	MIN	TYP	MAX	UNITS
<b>Power Supplies</b>							
Input Voltage Range	$V_{IN}$		Full	2.5		5.5	V
Feedback Input Bias Current	$I_{FB}$	$V_{FB} = 0.8V$	$+25^{\circ}C$			0.1	$\mu A$
Quiescent Current	$I_Q$	No Load, Not Switching	Full		26	40	$\mu A$
Shutdown Supply Current	$I_{SD}$	EN = GND	$+25^{\circ}C$		0.47	1	$\mu A$
Under-Voltage Lockout Threshold	$V_{UVLO}$	Rising $V_{IN}$	$+25^{\circ}C$		2.15	2.42	V
Under-Voltage Lockout Hysteresis	$V_{UVHYS}$		$+25^{\circ}C$		170		mV
<b>EN Logic Input</b>							
Enable High-Level Input Voltage	$V_{IH}$		Full	1.5			V
Enable Low-Level Input Voltage	$V_{IL}$		Full			0.3	V
<b>Switching</b>							
Switching Frequency	$f_{SW}$	$V_{IN} = 3.6V$	$+25^{\circ}C$	4	4.6	5.2	MHz
<b>Output</b>							
Regulated Feedback Voltage	$V_{FB}$		Full	0.777	0.8	0.826	V
Soft-Start	$t_{SS}$	From EN Rising Edge	$+25^{\circ}C$		200		$\mu s$
<b>Output Driver</b>							
PMOS On-Resistance	$R_{DS(ON)}$	$V_{IN} = V_{GS} = 3.6V$	$+25^{\circ}C$		350		$m\Omega$
NMOS On-Resistance		$V_{IN} = V_{GS} = 3.6V$	$+25^{\circ}C$		250		$m\Omega$
PMOS Peak Current Limit	$I_{LIM(OL)}$		$+25^{\circ}C$	1610	1900	2290	mA
Output Discharge Resistance	$R_{DIS}$	EN = GND	$+25^{\circ}C$		230		$\Omega$
Thermal Shutdown	$T_{TSD}$				160		$^{\circ}C$
Thermal Shutdown Hysteresis	$T_{HYS}$				15		$^{\circ}C$

TYPICAL PERFORMANCE CHARACTERISTICS

T<sub>A</sub> = +25°C, V<sub>IN</sub> = V<sub>EN</sub> = 3.6V, unless otherwise noted.

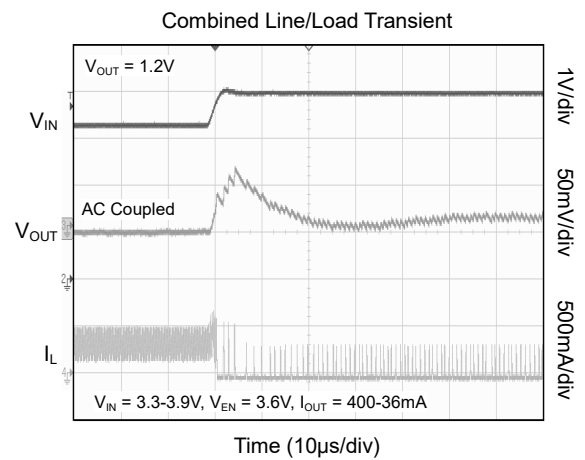
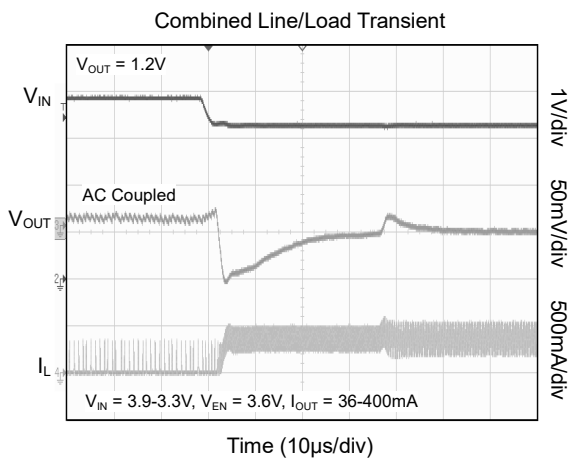
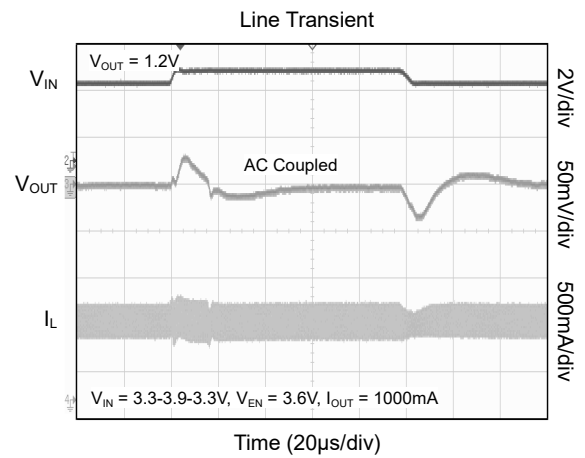
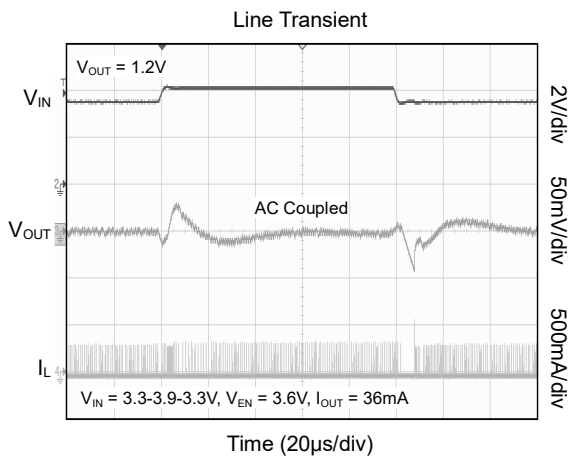
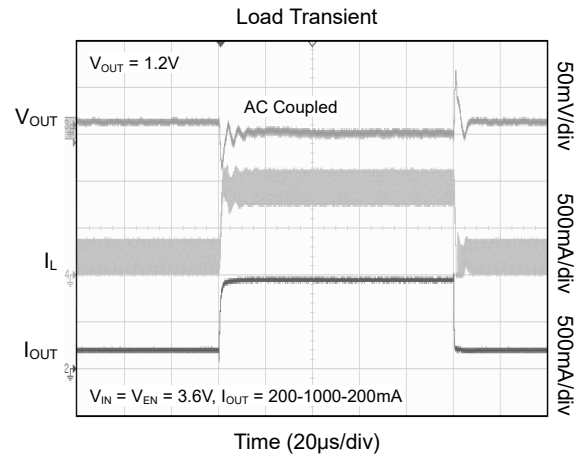
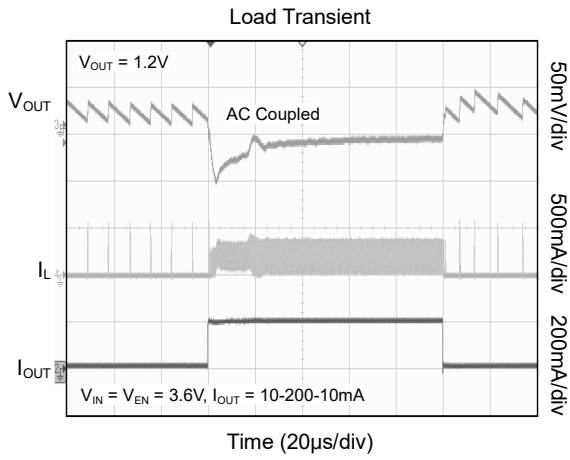

TYPICAL PERFORMANCE CHARACTERISTICS (continued)

T<sub>A</sub> = +25°C, V<sub>IN</sub> = V<sub>EN</sub> = 3.6V, unless otherwise noted.

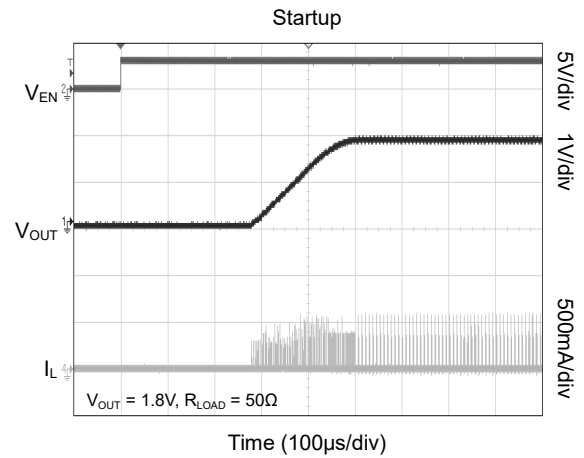
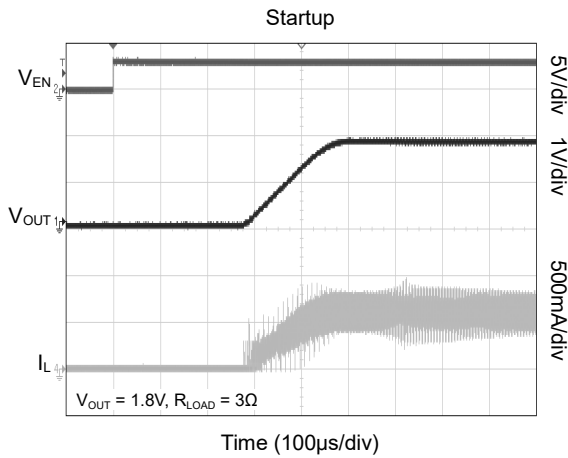
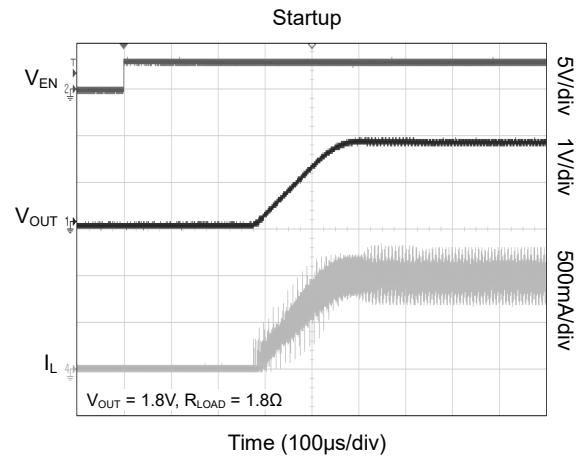
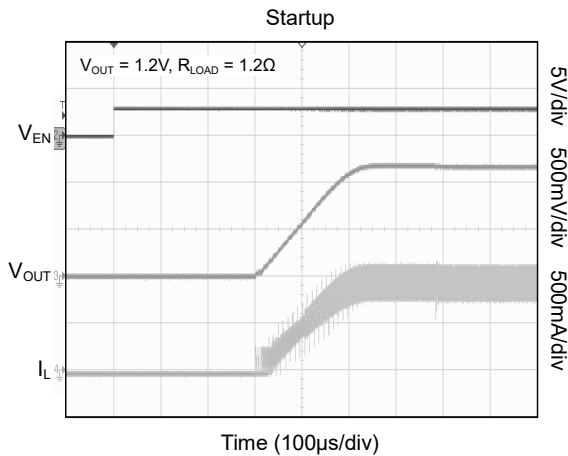
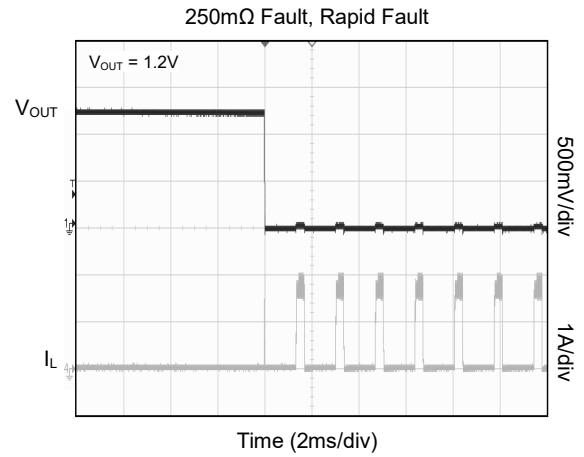
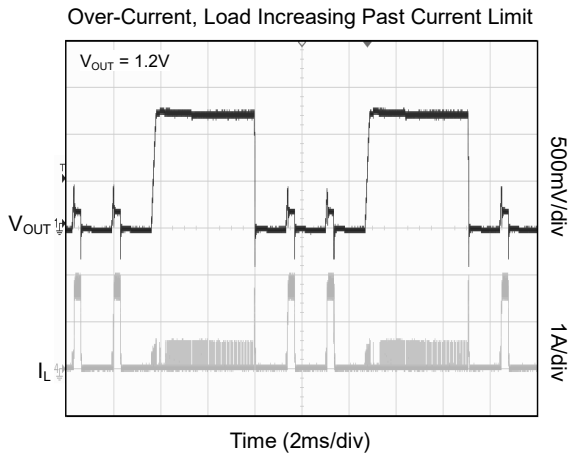

TYPICAL PERFORMANCE CHARACTERISTICS (continued)

T<sub>A</sub> = +25°C, V<sub>IN</sub> = V<sub>EN</sub> = 3.6V, unless otherwise noted.

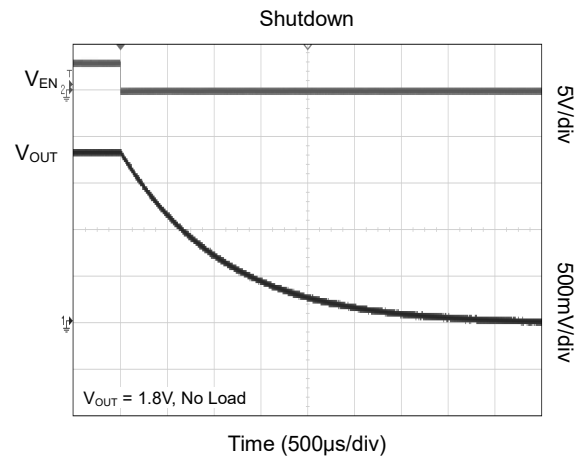
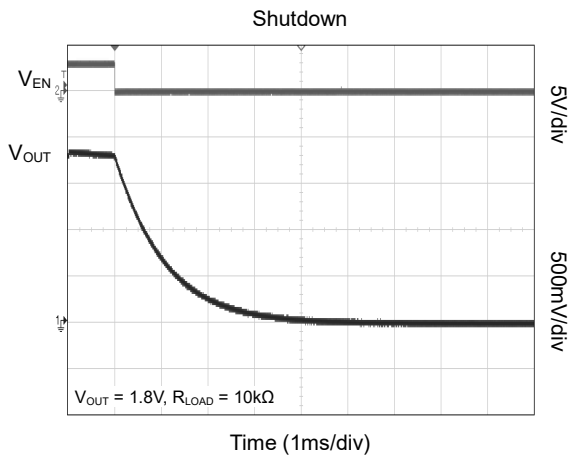
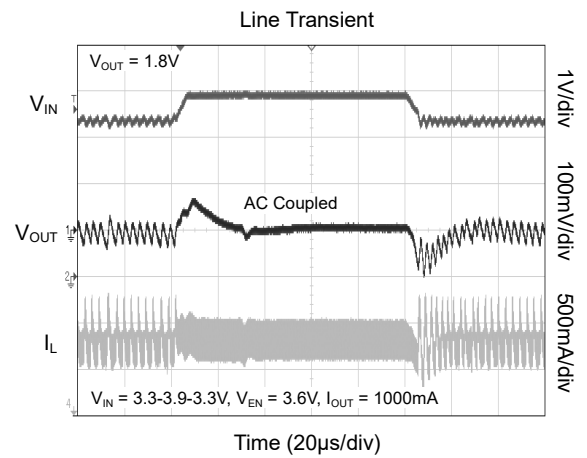
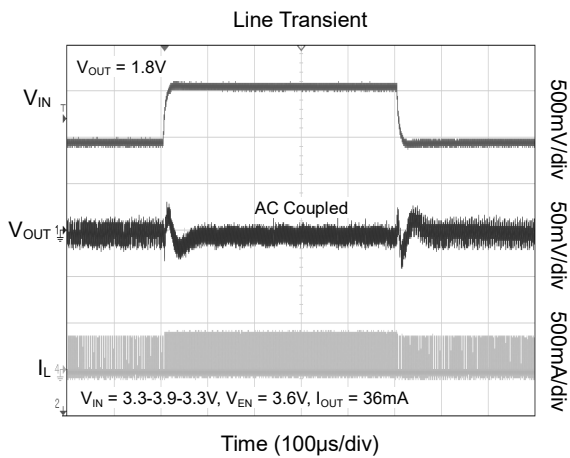
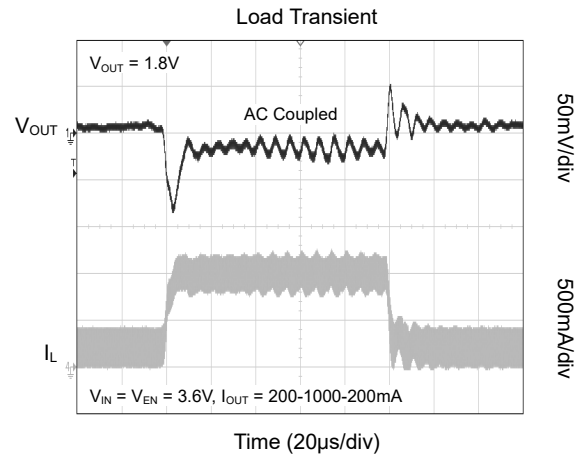
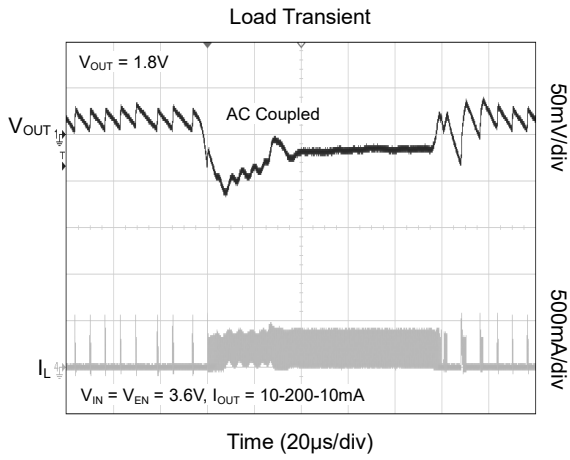

TYPICAL PERFORMANCE CHARACTERISTICS (continued)

T<sub>A</sub> = +25°C, V<sub>IN</sub> = V<sub>EN</sub> = 3.6V, unless otherwise noted.

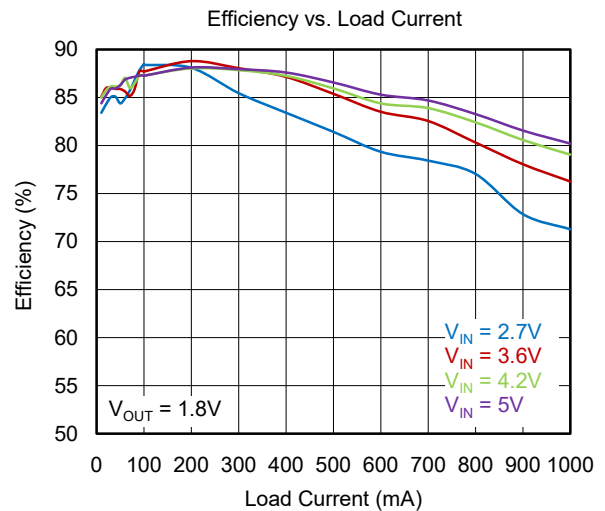
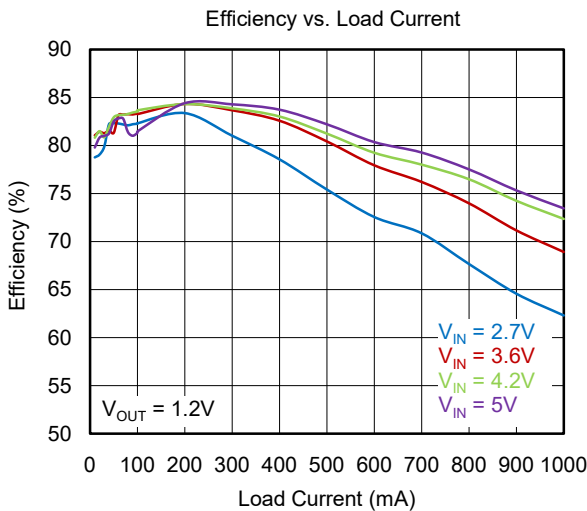
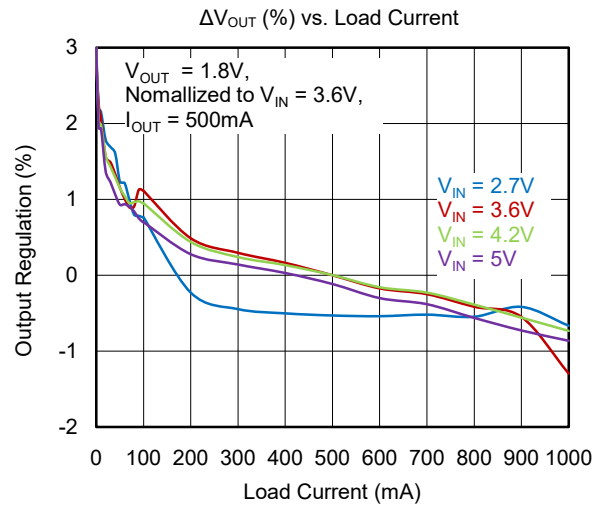
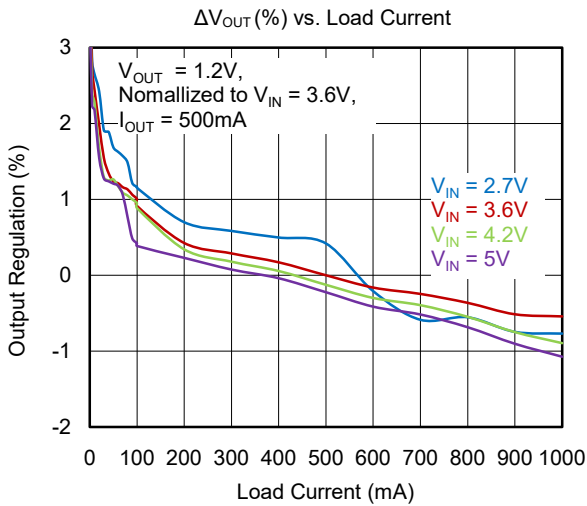
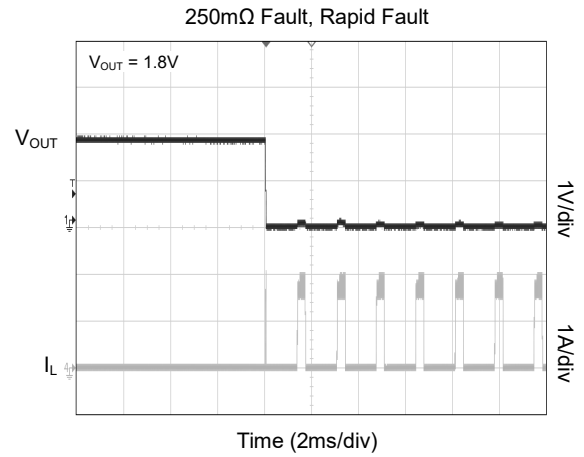
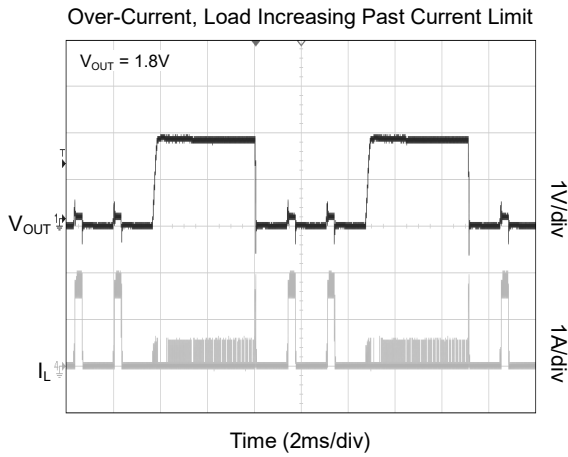



TYPICAL PERFORMANCE CHARACTERISTICS (continued)

T<sub>A</sub> = +25°C, V<sub>IN</sub> = V<sub>EN</sub> = 3.6V, unless otherwise noted.

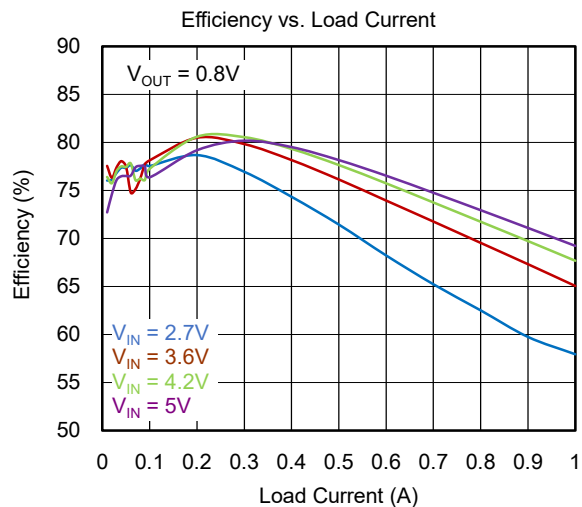
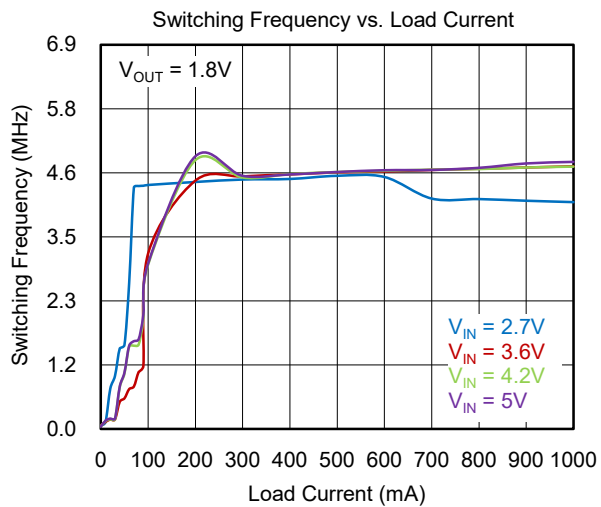

## DETAILED DESCRIPTION

The SGM6033 is a synchronous Buck converter capable of delivering 1A load to the output from an input supply range from 2.5V to 5.5V. The SGM6033 integrates a synchronous rectifier to improve the conversion efficiency up to 90% peak, while PFM mode light load efficiency reaches over 80% at 1mA load.

The device operates with 4.6MHz switching frequency at PWM mode which significantly reduces the external components size. The device only needs a 470nH inductor and  $2 \times 4.7\mu\text{F}$  as the output capacitors.

### Control Scheme

The SGM6033 adopts the COT architecture to regulate the output voltage while maintaining excellent load transient response. The device's internal frequency loop keeps the switching frequency constant at 4.6MHz throughout the input voltage range and load current. The device allows the use of low ESR ceramic capacitor to maintain output voltage regulation.

At light load, the SGM6033 automatically operates in PFM mode to achieve high light load efficiency. The device can seamlessly transit to PFM, DCM or CCM based on the load current.

### Soft-Start

Toggling the EN pin above the 1.5V rising threshold, the device starts switching with an internal soft-start time. During start-up, the internal reference voltage is slowly ramped up to the 0.8V reference voltage to prevent any output voltage overshoot and reduce the inrush current drawn from the input.

The current limit protection is active during soft-start, the device might not start up properly if heavy load is applied during start-up.

### Current Limit, Fault Shutdown and Restart

Output short-to-ground or output over-current will cause the peak inductor current flowing through the high-side switch to reach the current limit. If the current limit is triggered, the device stops switching, turning off the high-side FET to prevent the inductor current from continuing to rise. During the over-current event, the regulator shuts down for about 1.3ms, and the soft-start circuit attempts to restart for 200 $\mu\text{s}$ . If the over-current event remains, this pattern repeats, and the device automatically resumes operation if over-current condition is removed.

### Under-Voltage Lockout (UVLO)

The SGM6033 implements input voltage UVLO to stop device operation when the input voltage drops below the UVLO threshold. The device cannot restart again until the input voltage raises higher than the additional 170mV (TYP) hysteresis.

### Thermal Shutdown (TSD)

A thermal shutdown function is implemented to prevent damage caused by excessive heat and power dissipation. Once a temperature of typically +160°C is exceeded, the device is shut down. The device is released from shutdown automatically when the junction temperature decreases by 15°C.

## APPLICATION INFORMATION

### Setting the Output Voltage

The output voltage is programmed using a resistive voltage divider from the output voltage to FB pin. The voltage divider divides the output voltage down to the feedback voltage by the ratio:

$$V_{FB} = V_{OUT} \frac{R_2}{R_1 + R_2}$$

where  $V_{FB}$  is the feedback voltage and  $V_{OUT}$  is the output voltage. Thus the output voltage is:

$$V_{OUT} = 0.8 \times \frac{R_1 + R_2}{R_2}$$

The recommended value for  $R_2$  is between 200k $\Omega$  to 500k $\Omega$ .

### Selecting the Inductor

The selected inductor should have enough saturation current rating to meet the maximum load current. In addition, the selected inductor value affects the peak current, PWM to PFM transition point and efficiency. Use Equation below to calculate the inductor ripple current:

$$\Delta I \approx \frac{V_{OUT}}{V_{IN}} \cdot \left( \frac{V_{IN} - V_{OUT}}{L \cdot f_{SW}} \right) \quad (1)$$

The maximum load current,  $I_{MAX(Load)}$  can be calculated using Equation below:

$$I_{MAX(Load)} = I_{LIM(PK)} - \left( \frac{\Delta I}{2} \right) \quad (2)$$

When the inductor's valley current crosses zero, the device transits from PFM to PWM operation. Use Equation below to calculate the DC current when the inductor current reaches zero:

$$I_{DCM} = \frac{\Delta I}{2} \quad (3)$$

470nH is recommended for SGM6033. For application's duty cycle higher than 60%, 1 $\mu$ H inductor is recommended. In addition, the recommended maximum operation duty cycle for SGM6033 is 75%. The selected inductor should have at least 80% of the inductance at  $I_{LIM(PK)}$ .

Inductor's DCR and inductance affect the conversion efficiency. Inductor with lower inductance generally has lower DCR which improves the efficiency, however, the RMS current is increased due to increased peak to

peak ripple current  $\Delta I$ . Higher  $\Delta I$  increases the inductor core loss which reduces the efficiency. Use Equation below to calculate the inductor RMS current:

$$I_{RMS} = \sqrt{I_{OUT(DC)}^2 + \frac{\Delta I^2}{12}} \quad (4)$$

Higher inductance results in lower RMS current, however, transient response is degraded. For the same family of inductors, higher inductance parts result in higher DCR and lower saturation current.

Table 1 summarizes the performance effects of inductance higher or lower than the recommended 0.47 $\mu$ H inductor.

**Table 1. Effects of Changes in Inductor Value (from 470nH Recommended Value)**

INDUCTOR VALUE	$I_{MAX(Load)}$	$\Delta V_{OUT}$	TRANSIENT RESPONSE
Increase	Increase	Decrease	Degraded
Decrease	Decrease	Increase	Improved

### Input Capacitor

A 2.2 $\mu$ F ceramic input capacitor is recommended to place as close as possible between the VIN pin and GND to minimize the parasitic inductance. For the applications where the SGM6033 is located far away from the input source, a 47 $\mu$ F or higher capacitance capacitor is recommended to damp the wiring harness's inductance.

### Output Capacitor

A 4.7 $\mu$ F 0402 ceramic output capacitor is recommended for SGM6033. Larger size as 0603 results in higher effective capacitance under the same DC de-rating, which improves transient response and output ripple.

Use Equation below to calculate the output voltage ripple:

$$\Delta V_{OUT} = \Delta I_L \left[ \frac{f_{SW} \cdot C_{OUT} \cdot ESR^2}{2 \cdot D \cdot (1-D)} + \frac{1}{8 \cdot f_{SW} \cdot C_{OUT}} \right] \quad (5)$$

**APPLICATION INFORMATION (continued)**

**Table 2. Recommended Passive Components and their Variation Due to DC Bias**

COMPONENT	DESCRIPTION	VENDOR	MIN	TYP	MAX
L	470nH, 2012, 90mΩ, 1.1A	Murata LQM21PNR47MC0 Murata LQM21PNR54MG0 Hitachi Metals HLSI 201210R47		470nH	
L	1μH, 2012, 0.1Ω, 1.5A	Murata LQM21PN1R0MGH		1μH	
L	1μH, 2012, 0.067Ω, 3.4A	Sunlord WPG201210UF1R0MT		1μH	
L	0.47μH, 2012, 0.033Ω, 5.15A	Sunlord WPG201210UFR47MT		0.47μH	
C <sub>IN</sub>	2.2μF, 6.3V, X5R, 0402	Murata or Equivalent GRM155R60J225ME15 GRM188R60J225KE19D	1.0μF	2.2μF	
C <sub>OUT</sub>	4.7μF, X5R, 0402	Murata or Equivalent GRM155R60G475M GRM155R60E475ME760	4.7μF	2 × 4.7μF	
C <sub>OUT</sub> (when V <sub>OUT</sub> is lower than 1V)	10μF, X5R, 0402	Murata	10μF	22μF	
R <sub>2</sub>			200kΩ		500kΩ
C <sub>1</sub>	22pF		15pF	22pF	30pF

**PCB Layout Guidelines**

In addition to component selection, layout is a critical step to ensure the performance of any switch mode power supplies. Poor layout could result in system instability, EMI failure, and device damage. Thus, place the inductor, input and output capacitors as close to the

IC as possible, and use wide and short traces for current carrying traces to minimize PCB inductance. For Buck converter, the input capacitor’s current loop from VIN pin back to the GND pin of the device should be as small as possible.

**REVISION HISTORY**

NOTE: Page numbers for previous revisions may differ from page numbers in the current version.

JUNE 2022 – REV.A.1 to REV.A.2	Page
Added Efficiency vs. Load Current Performance.....	9
Updated the Detailed Description and Application Information sections .....	10, 11, 12
JULY 2020 – REV.A to REV.A.1	Page
Updated the Operating Temperature Range .....	1, 2, 4
Changes from Original (JANUARY 2019) to REV.A	
Changed from product preview to production data .....	All

PACKAGE OUTLINE DIMENSIONS

TDFN-2x2-6L

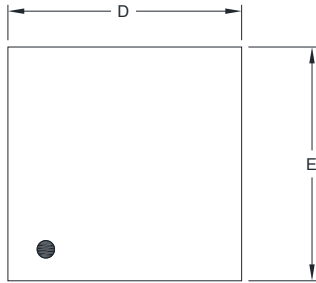

TOP VIEW

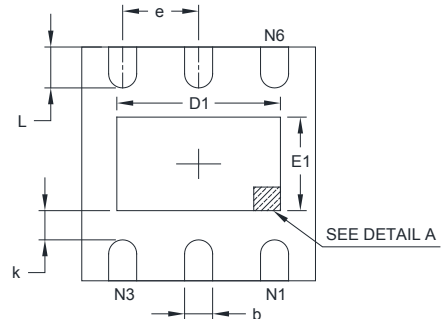

BOTTOM VIEW

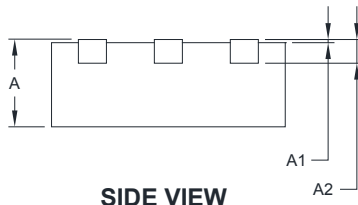

SIDE VIEW

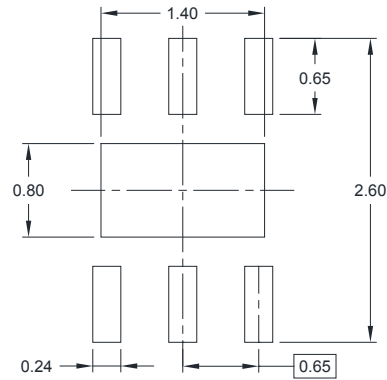

RECOMMENDED LAND PATTERN (Unit: mm)

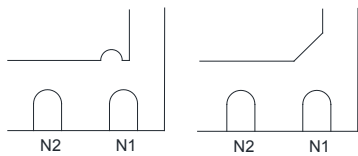

DETAIL A

Pin #1 ID and Tie Bar Mark Options

NOTE: The configuration of the Pin #1 identifier is optional, but must be located within the zone indicated.

Symbol	Dimensions In Millimeters		Dimensions In Inches	
	MIN	MAX	MIN	MAX
A	0.700	0.800	0.028	0.031
A1	0.000	0.050	0.000	0.002
A2	0.203 REF		0.008 REF	
D	1.900	2.100	0.075	0.083
D1	1.100	1.450	0.043	0.057
E	1.900	2.100	0.075	0.083
E1	0.600	0.850	0.024	0.034
k	0.200 MIN		0.008 MIN	
b	0.180	0.300	0.007	0.012
e	0.650 TYP		0.026 TYP	
L	0.250	0.450	0.010	0.018

# PACKAGE INFORMATION

## PACKAGE OUTLINE DIMENSIONS

### WLCSP-1.21×0.81-6B

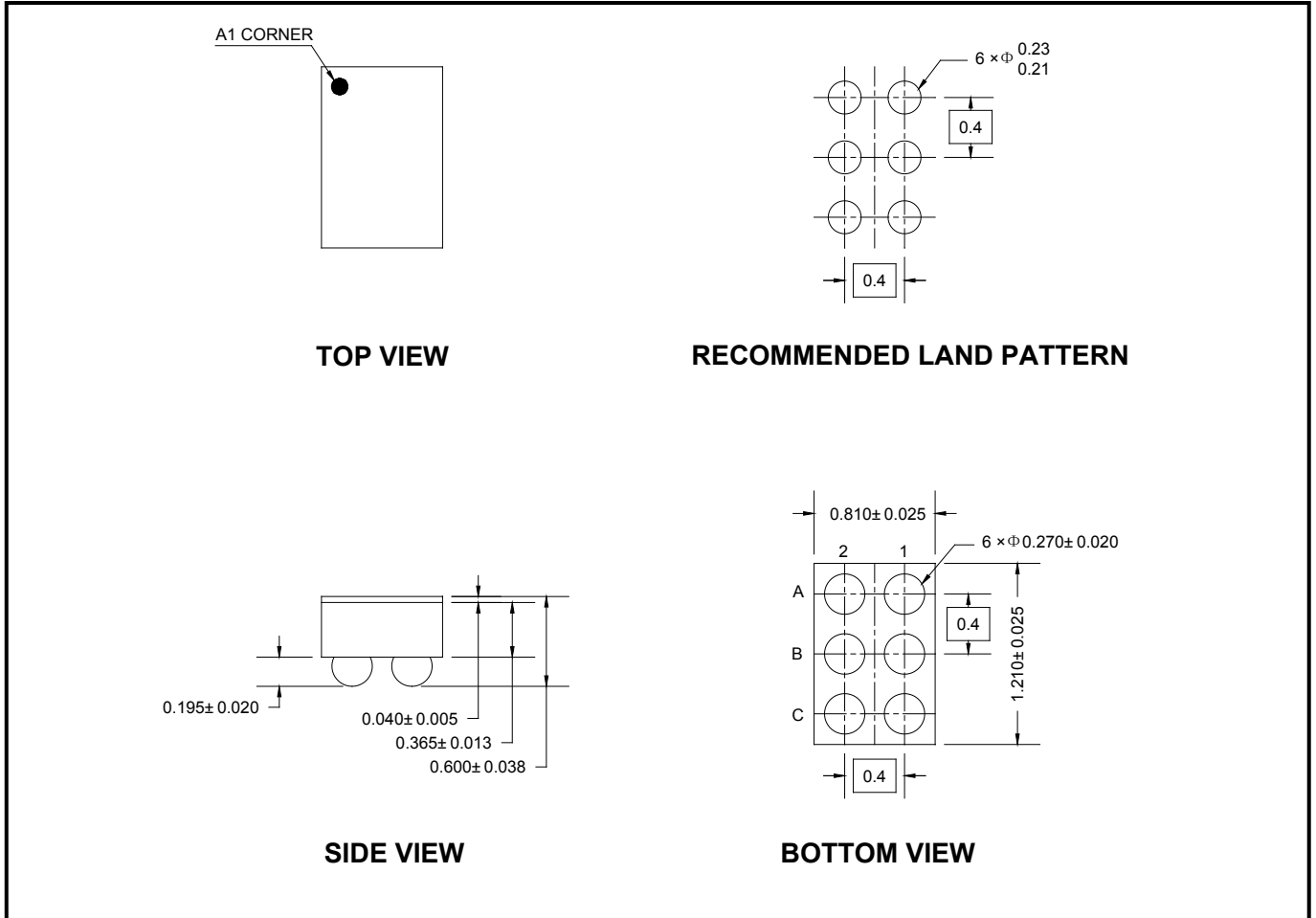

NOTE: All linear dimensions are in millimeters.

# PACKAGE INFORMATION

## TAPE AND REEL INFORMATION

### REEL DIMENSIONS



### TAPE DIMENSIONS



NOTE: The picture is only for reference. Please make the object as the standard.

### KEY PARAMETER LIST OF TAPE AND REEL

Package Type	Reel Diameter	Reel Width W1 (mm)	A0 (mm)	B0 (mm)	K0 (mm)	P0 (mm)	P1 (mm)	P2 (mm)	W (mm)	Pin1 Quadrant
TDFN-2×2-6L	7"	9.5	2.30	2.30	1.10	4.0	4.0	2.0	8.0	Q1
WLCSP-1.21×0.81-6B	7"	9.2	0.90	1.32	0.68	4.0	4.0	2.0	8.0	Q1

000001

# PACKAGE INFORMATION

## CARTON BOX DIMENSIONS



NOTE: The picture is only for reference. Please make the object as the standard.

## KEY PARAMETER LIST OF CARTON BOX

Reel Type	Length (mm)	Width (mm)	Height (mm)	Pizza/Carton
7" (Option)	368	227	224	8
7"	442	410	224	18

DD0002