

GENERAL DESCRIPTION

The SGM9346 is a 6-channel, 6th-order output reconstruction filter which can operate from 3.3V to 5.5V single power supply. It is designed to replace passive LC filters and drivers with an integrated device. Compared with typical passive solutions, the six 6th-order Butterworth filters provide better image quality than typical passive solutions. Three channels are fixed Standard Definition (SD) filters while the rest three channels are configurable between High Definition (HD) or Standard Definition (SD) filters.

The device has a 6dB gain, allowing DC- or AC-coupled output. SGM9346 can be DC-coupled or AC-coupled with input video signal to eliminate out-of-band noise, such as the output stage of DAC. Internal clamp circuitry may be used if AC-coupled inputs are required.

SGM9346 is available in a Green TSSOP-20 package. It operates over an ambient temperature range of -40°C to +85°C.

BLOCK DIAGRAM

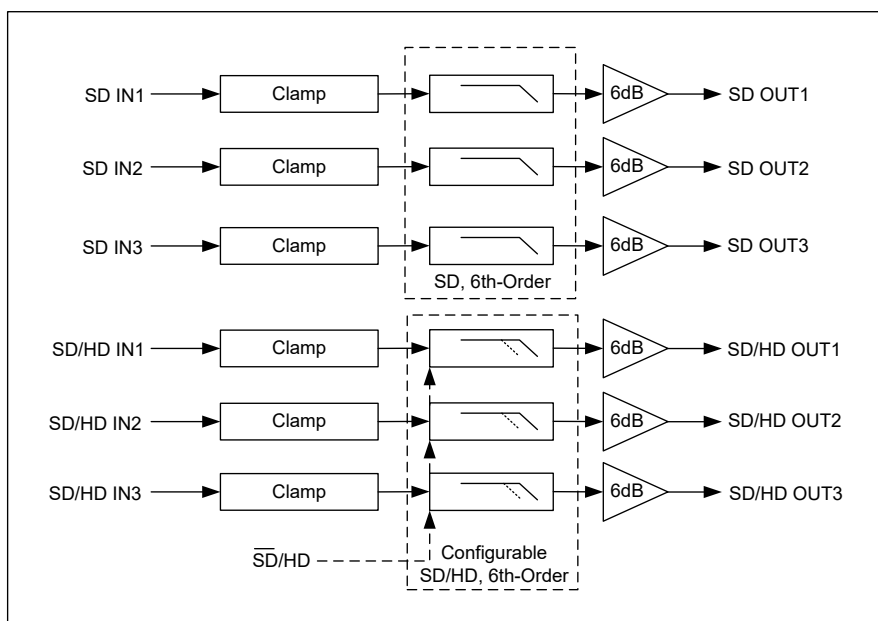

FEATURES

- **Supply Voltage Range: 3.3V to 5.5V**
- **Three Fixed 6th-Order Standard Definition Filters**
- **Three Configurable 6th-Order SD/HD Filters**
- **Internal Gain: 6dB**
- **Clamp Mode Active with AC-Coupled Inputs**
- **Clamp Mode Inactive with DC-Coupled Inputs**
- **AC- or DC-Coupled Outputs**
- **-40°C to +85°C Operating Temperature Range**
- **Available in a Green TSSOP-20 Package**

APPLICATIONS

- Video on Demand (VOD)
- Set-Top Boxes
- Personal Video Recorders (PVR)
- TVs

PACKAGE/ORDERING INFORMATION

MODEL	PACKAGE DESCRIPTION	SPECIFIED TEMPERATURE RANGE	ORDERING NUMBER	PACKAGE MARKING	PACKING OPTION
SGM9346	TSSOP-20	-40°C to +85°C	SGM9346YTS20	SGM9346YTS20 XXXXX	Tape and Reel, 3000

MARKING INFORMATION

NOTE: XXXXX = Date Code and Vendor Code.

XXXXX

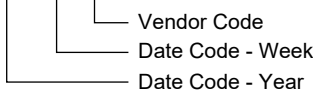

Green (RoHS & HSF): SG Micro Corp defines "Green" to mean Pb-Free (RoHS compatible) and free of halogen substances. If you have additional comments or questions, please contact your SGMICRO representative directly.

Analog and Digital Input/Output Voltage	GND - 0.3V to $V_{CC} + 0.3V$
DC Supply Voltage, V_{CC}	6.0V
Junction Temperature	+150°C
Storage Temperature Range	-65°C to +150°C
Lead Temperature (Soldering, 10s)	+260°C
ESD Susceptibility	
HBM	8000V
MM	400V

RECOMMENDED OPERATING CONDITIONS

Operating Voltage Range	3.3V to 5.5V
Operating Temperature Range	-40°C to +85°C

OVERSTRESS CAUTION

Stresses beyond those listed in Absolute Maximum Ratings may cause permanent damage to the device. Exposure to absolute maximum rating conditions for extended periods may affect reliability. Functional operation of the device at any conditions beyond those indicated in the Recommended Operating Conditions section is not implied.

ESD SENSITIVITY CAUTION

This integrated circuit can be damaged if ESD protections are not considered carefully. SGMICRO recommends that all integrated circuits be handled with appropriate precautions. Failure to observe proper handling and installation procedures can cause damage. ESD damage can range from subtle performance degradation to complete device failure. Precision integrated circuits may be more susceptible to damage because even small parametric changes could cause the device not to meet the published specifications.

DISCLAIMER

SG Micro Corp reserves the right to make any change in circuit design, or specifications without prior notice.

PIN CONFIGURATION

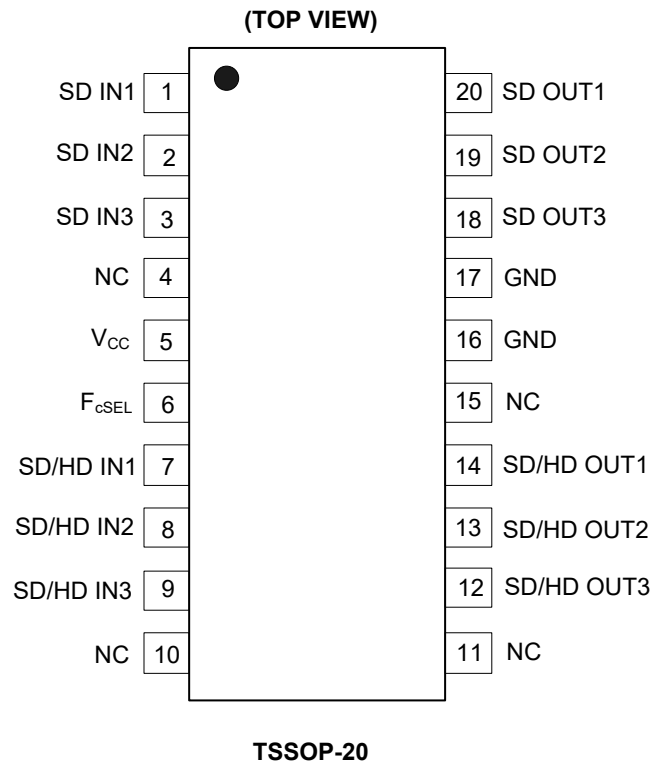

PIN DESCRIPTION

PIN	NAME	FUNCTION
1	SD IN1	SD Video Input for Channel 1.
2	SD IN2	SD Video Input for Channel 2.
3	SD IN3	SD Video Input for Channel 3.
4, 10, 11, 15	NC	No Connection.
5	V _{CC}	Power Supply.
6	F _{cSEL}	Selects Filter Corner Frequency for Pins 7, 8 and 9. "0" = SD, "1" = HD.
7	SD/HD IN1	SD or HD Video Input for Channel 1.
8	SD/HD IN2	SD or HD Video Input for Channel 2.
9	SD/HD IN3	SD or HD Video Input for Channel 3.
12	SD/HD OUT3	Filtered SD or HD Video Output for Channel 3.
13	SD/HD OUT2	Filtered SD or HD Video Output for Channel 2.
14	SD/HD OUT1	Filtered SD or HD Video Output for Channel 1.
16, 17	GND	Ground.
18	SD OUT3	Filtered SD Video Output for Channel 3.
19	SD OUT2	Filtered SD Video Output for Channel 2.
20	SD OUT1	Filtered SD Video Output for Channel 1.

ELECTRICAL CHARACTERISTICS

($T_A = +25^\circ\text{C}$, $V_{CC} = 5\text{V}$, at $R_L = 150\Omega$ connected to GND, $V_{IN} = 1V_{PP}$, all outputs AC-coupled with $220\mu\text{F}$, Full = -40°C to $+85^\circ\text{C}$, unless otherwise noted.)

PARAMETER	CONDITIONS	TEMP	MIN	TYP	MAX	UNITS
Input Characteristics						
Output Level Shift Voltage (V_{OLS})	$V_{IN} = 0\text{V}$, No load	+25°C		503	630	mV
		Full			739	
Input Voltage Clamp (V_{CLAMP})	$I_{IN} = -3.5\text{mA}$	+25°C	-163	-131		mV
		Full	-243			
Clamp Charge Current	$V_{IN} = V_{CLAMP} - 100\text{mV}$	+25°C	-5.43	-5		mA
		Full	-6.5			
Voltage Gain (A_v)	$R_L = 150\Omega$	+25°C	5.89	6.13	6.32	dB
		Full	5.85		6.4	
Output Characteristics						
Output Voltage High Swing	$V_{IN} = 3\text{V}$, $R_L = 150\Omega$ to GND	+25°C	4.71	4.77		V
		Full	4.65			
Power Supply						
Operating Voltage Range		+25°C	3.3		5.5	V
Power Supply Rejection Ratio (PSRR)	$V_{CC} = 3.5\text{V}$ to 5.0V	+25°C	47	59		dB
		Full	40.5			
Quiescent Current (I_Q)	$V_{IN} = 0\text{V}$, No load	+25°C		64.5	83	mA
		Full			95	
AC Performance (Standard Definition Mode)						
-0.1dB Bandwidth	$R_L = 150\Omega$	+25°C		5.36		MHz
-3dB Bandwidth	$R_L = 150\Omega$	+25°C		8.18		MHz
Filter Response (Normalized Gain)	$f_{IN} = 27\text{MHz}$	+25°C		-45.5		dB
Slew Rate	2V Output step, 80% to 20%	+25°C		39.5		V/ μs
Differential Gain (DG)	PAL DC-coupled	+25°C		0.15		%
	PAL AC-coupled	+25°C		0.66		
Differential Phase (DP)	PAL DC-coupled	+25°C		1.10		°
	PAL AC-coupled	+25°C		1.75		
Group Delay Variation (D/DT)	Difference between 400kHz and 4.5MHz	+25°C		10.5		ns
Crosstalk (channel-to-channel)	$f = 1\text{MHz}$	+25°C		-68		dB
Fall Time	2V Output step, 80% to 20%	+25°C		30.5		ns
Rise Time	2V Output step, 80% to 20%	+25°C		30.4		ns
Output Distortion (THD)	$V_{OUT} = 1.4V_{PP}$, 3.58MHz	+25°C		1.00		%

ELECTRICAL CHARACTERISTICS (continued)

(TA = +25°C, VCC = 5V, at RL = 150Ω connected to GND, VIN = 1VPP, all outputs AC-coupled with 220μF, Full = -40°C to +85°C, unless otherwise noted.)

PARAMETER	CONDITIONS	TEMP	MIN	TYP	MAX	UNITS
AC Performance (High Definition Mode)						
-0.1dB Bandwidth	RL = 150Ω	+25°C		28.2		MHz
-3dB Bandwidth	RL = 150Ω	+25°C		35.5		MHz
Filter Response (Normalized Gain)	fIN = 74.25MHz	+25°C		-37.5		dB
Slew Rate	2V Output step, 80% to 20%	+25°C		140		V/μs
Differential Gain (DG)	PAL DC-coupled	+25°C		0.06		%
	PAL AC-coupled	+25°C		0.37		
Differential Phase (DP)	PAL DC-coupled	+25°C		0.40		°
	PAL AC-coupled	+25°C		0.53		
Group Delay Variation (D/DT)	Difference between 400kHz and 20MHz	+25°C		4.90		ns
Crosstalk (channel-to-channel)	f = 1MHz	+25°C		-71		dB
Fall Time	2V Output step, 80% to 20%	+25°C		8.50		ns
Rise Time	2V Output step, 80% to 20%	+25°C		8.40		ns
Output Distortion (THD)	VOUT = 1.4VPP, 22MHz	+25°C		2.30		%

TYPICAL PERFORMANCE CHARACTERISTICS

At $V_{CC} = 5V$, $T_A = +25^{\circ}C$, $R_L = 150\Omega$, all outputs AC-coupled with $220\mu F$, unless otherwise noted.

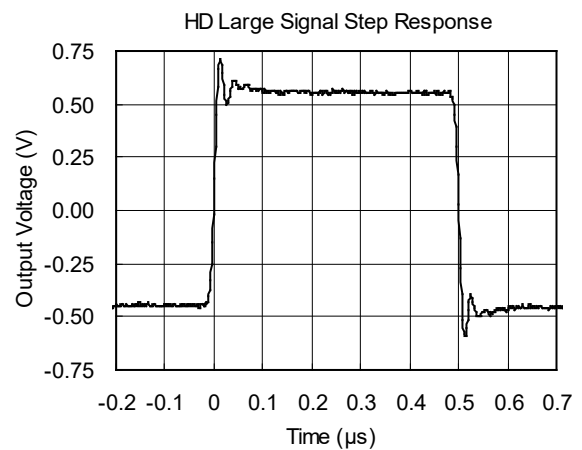
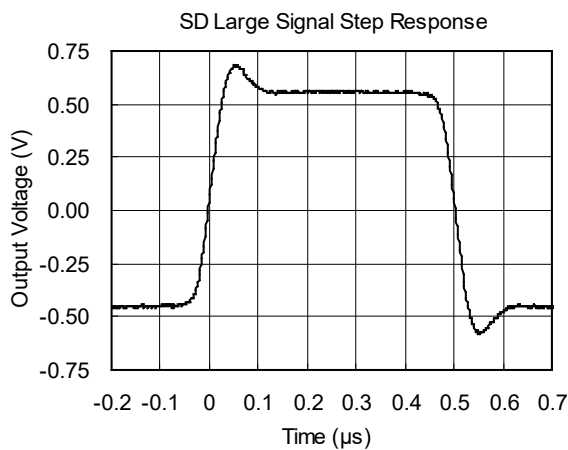
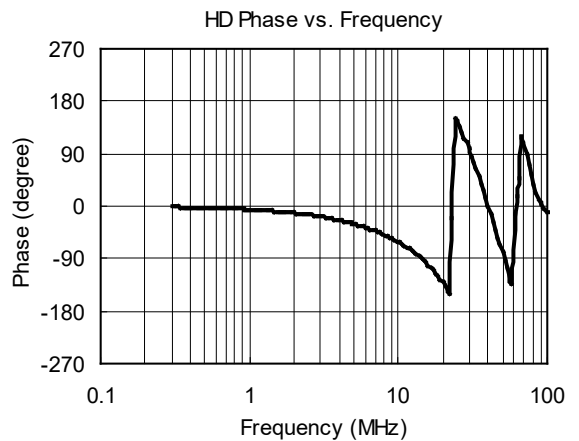
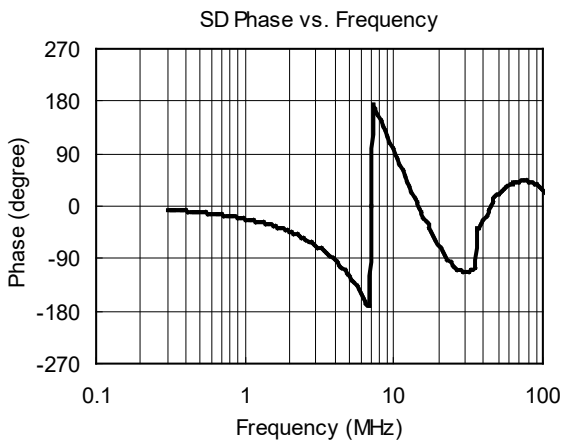
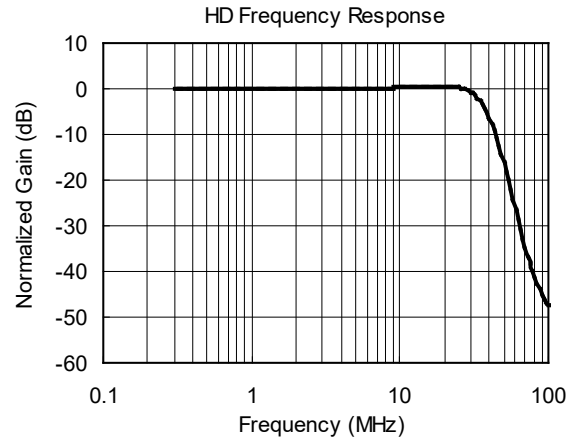
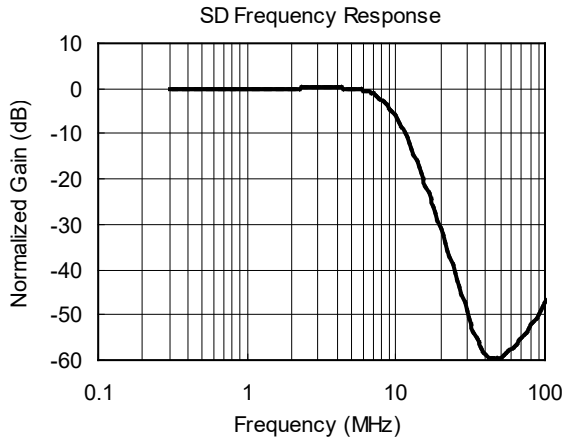

TYPICAL PERFORMANCE CHARACTERISTICS (continued)

At $V_{CC} = 5V$, $T_A = +25^\circ C$, $R_L = 150\Omega$, all outputs AC-coupled with $220\mu F$, unless otherwise noted.

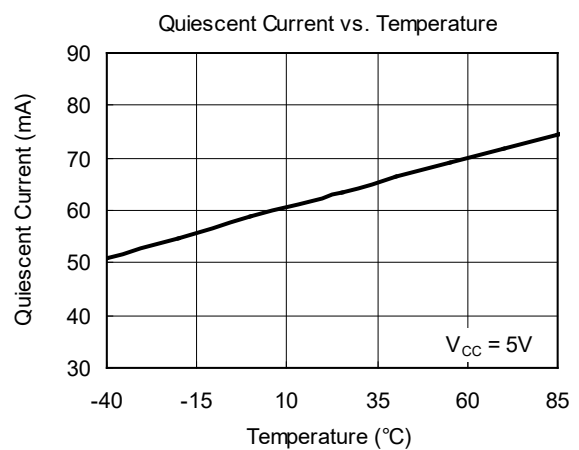
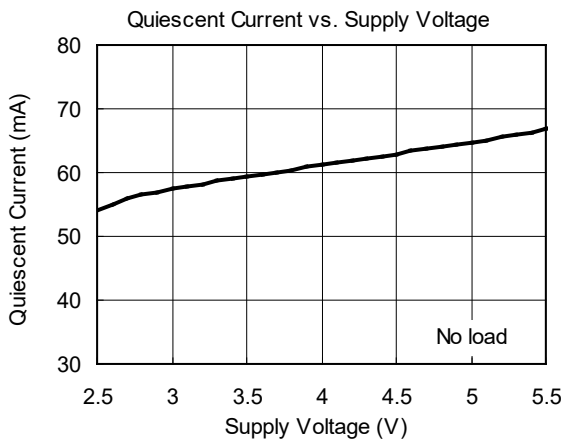
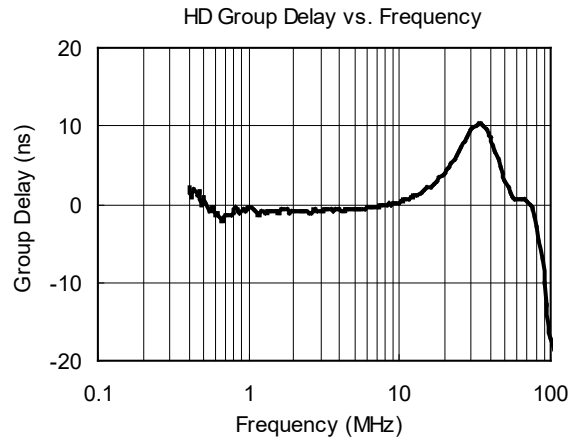
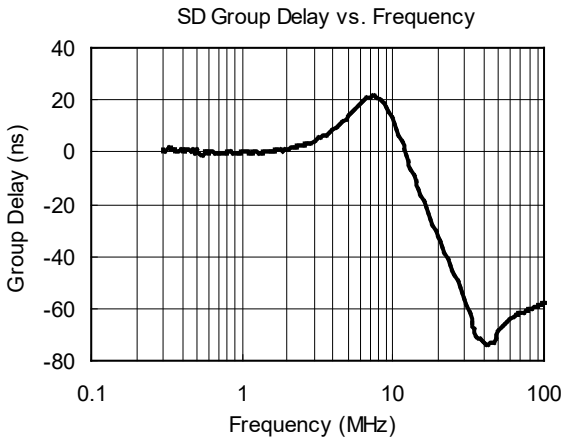
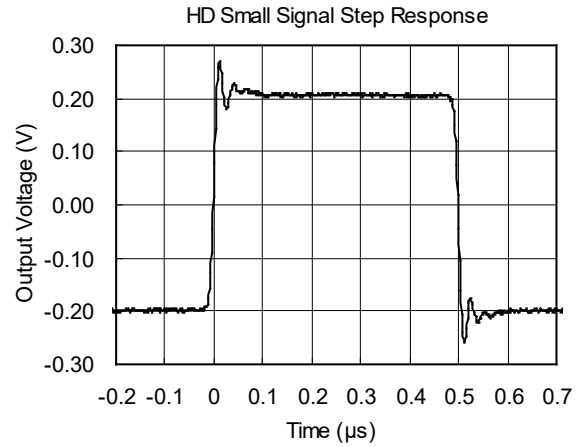
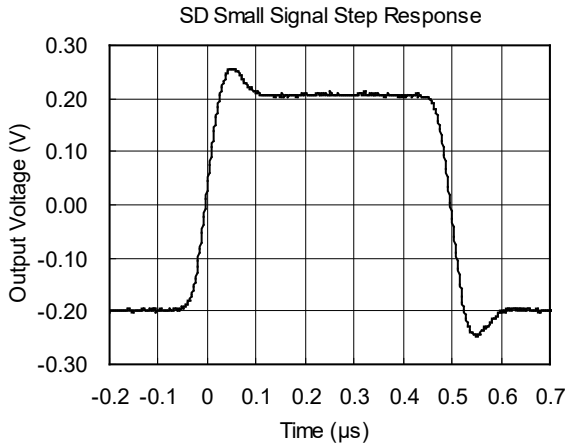

TYPICAL PERFORMANCE CHARACTERISTICS (continued)

At $V_{CC} = 5V$, $T_A = +25^\circ C$, $R_L = 150\Omega$, all outputs AC-coupled with $220\mu F$, unless otherwise noted.

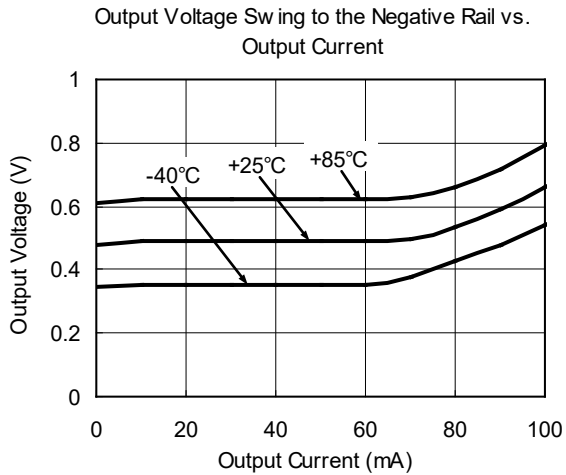
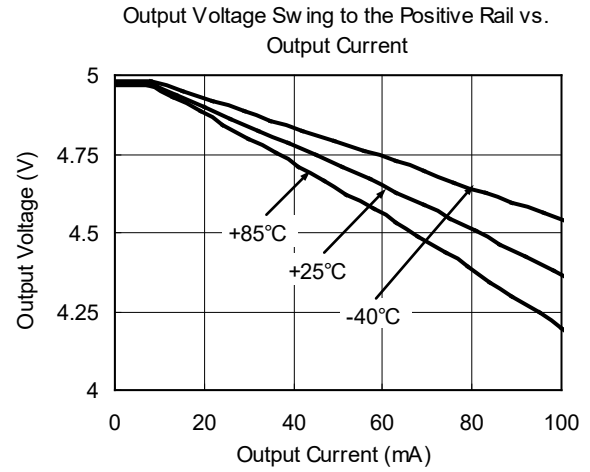
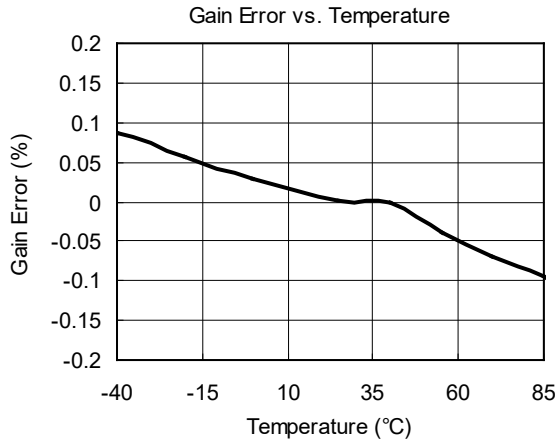

PACKAGE OUTLINE DIMENSIONS

TSSOP-20

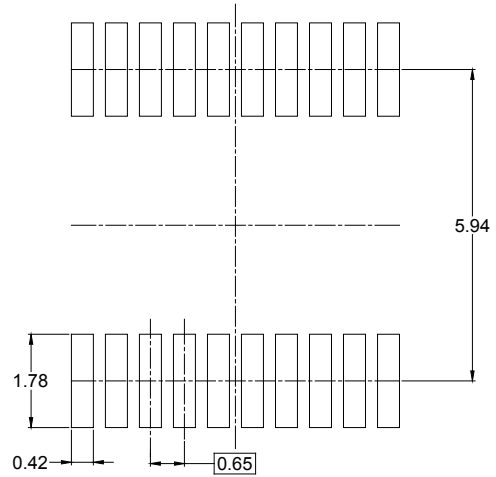
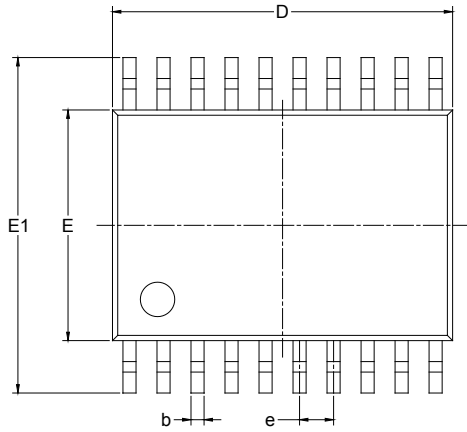

RECOMMENDED LAND PATTERN (Unit: mm)

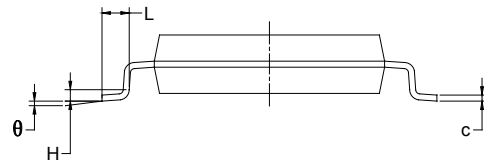
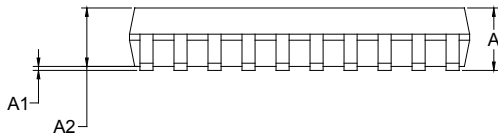

Symbol	Dimensions In Millimeters		Dimensions In Inches	
	MIN	MAX	MIN	MAX
A		1.100		0.043
A1	0.050	0.150	0.002	0.006
A2	0.800	1.000	0.031	0.039
b	0.190	0.300	0.007	0.012
c	0.090	0.200	0.004	0.008
D	6.400	6.600	0.252	0.259
E	4.300	4.500	0.169	0.177
E1	6.250	6.550	0.246	0.258
e	0.650 BSC		0.026 BSC	
L	0.500	0.700	0.02	0.028
H	0.25 TYP		0.01 TYP	
θ	1°	7°	1°	7°

TAPE AND REEL INFORMATION

REEL DIMENSIONS



TAPE DIMENSIONS



NOTE: The picture is only for reference. Please make the object as the standard.

KEY PARAMETER LIST OF TAPE AND REEL

Package Type	Reel Diameter	Reel Width W1 (mm)	A0 (mm)	B0 (mm)	K0 (mm)	P0 (mm)	P1 (mm)	P2 (mm)	W (mm)	Pin1 Quadrant
TSSOP-20	13"	12.4	6.80	6.85	1.70	4.0	8.0	2.0	12.0	Q1

DD0001

PACKAGE INFORMATION

CARTON BOX DIMENSIONS



NOTE: The picture is only for reference. Please make the object as the standard.

KEY PARAMETER LIST OF CARTON BOX

Reel Type	Length (mm)	Width (mm)	Height (mm)	Pizza/Carton
13"	386	280	370	5

DD0002