



# SGM8772

## High Voltage, High Precision, Dual Differential Comparator with $V_{REF}$

---

### GENERAL DESCRIPTION

The SGM8772 is a dual, high precision differential voltage comparator with a voltage reference and a NAND gate. The device optimized for high voltage operation from 2.8V to 36V single supply or  $\pm 1.4V$  to  $\pm 18V$  dual power supplies. It consumes low supply current without being affected by the supply voltage. Input common mode voltage is 1.5V lower than  $+V_S$ . The SGM8772 has a push-pull output structure without external pull-up resistors. This feature makes it a good choice for applications whose PCB sizes are limited. The SGM8772 also provides one window comparator output.

The SGM8772 is available in a Green MSOP-10 package. It is operated over the  $-40^{\circ}C$  to  $+125^{\circ}C$  temperature range.

### FEATURES

- **Wide Supply Ranges**
  - Single Supply: 2.8V to 36V
  - Dual Supplies:  $\pm 1.4V$  to  $\pm 18V$
- **Low Supply Current: 420 $\mu$ A (TYP)**
- **Low Input Offset Voltage: 4mV (MAX)**
- **Low Input Bias Current:  $\pm 20pA$  (TYP)**
- **Minimum Input Common Mode Voltage:  $-V_S$**
- **Maximum Differential Input Voltage:  $+36V/-36V$**
- **Push-Pull Output and Window Comparator Output**
- **Low Output Saturation Voltage**
- **Supports CMOS or TTL Logic**
- **$-40^{\circ}C$  to  $+125^{\circ}C$  Operating Temperature Range**
- **Available in a Green MSOP-10 Package**

### APPLICATIONS

Power System Monitor  
Medical Equipment  
Industrial Application  
Battery Management System

**PACKAGE/ORDERING INFORMATION**

MODEL	PACKAGE DESCRIPTION	SPECIFIED TEMPERATURE RANGE	ORDERING NUMBER	PACKAGE MARKING	PACKING OPTION
SGM8772	MSOP-10	-40°C to +125°C	SGM8772XMS10G/TR	SGM8772 XMS10 XXXXX	Tape and Reel, 4000

**MARKING INFORMATION**

NOTE: XXXXX = Date Code, Trace Code and Vendor Code.

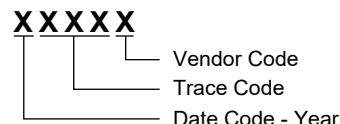

Green (RoHS & HSF): SG Micro Corp defines "Green" to mean Pb-Free (RoHS compatible) and free of halogen substances. If you have additional comments or questions, please contact your SGMICRO representative directly.

**ABSOLUTE MAXIMUM RATINGS**

- Supply Voltage, V<sub>S</sub>..... 40V
- Differential Input Voltage, |V<sub>ID</sub>| ..... 40V
- Input Voltage Range ..... (-V<sub>S</sub>) - 0.3V to (+V<sub>S</sub>) + 0.3V
- Output Voltage Range, V<sub>OUT</sub> ..... (-V<sub>S</sub>) - 0.3V to (+V<sub>S</sub>) + 0.3V
- Output Voltage Range, V<sub>REF</sub> ..... (-V<sub>S</sub>) - 0.3V to (-V<sub>S</sub>) + 5.5V
- Junction Temperature.....+150°C
- Storage Temperature Range ..... -65°C to +150°C
- Lead Temperature (Soldering, 10s).....+260°C
- ESD Susceptibility
- HBM.....2500V
- CDM ..... 1000V

**RECOMMENDED OPERATING CONDITIONS**

- Operating Temperature Range .....-40°C to +125°C

**OVERSTRESS CAUTION**

Stresses beyond those listed in Absolute Maximum Ratings may cause permanent damage to the device. Exposure to absolute maximum rating conditions for extended periods may affect reliability. Functional operation of the device at any conditions beyond those indicated in the Recommended Operating Conditions section is not implied.

**ESD SENSITIVITY CAUTION**

This integrated circuit can be damaged if ESD protections are not considered carefully. SGMICRO recommends that all integrated circuits be handled with appropriate precautions. Failure to observe proper handling and installation procedures can cause damage. ESD damage can range from subtle performance degradation to complete device failure. Precision integrated circuits may be more susceptible to damage because even small parametric changes could cause the device not to meet the published specifications.

**DISCLAIMER**

SG Micro Corp reserves the right to make any change in circuit design, or specifications without prior notice.

**PIN CONFIGURATION**

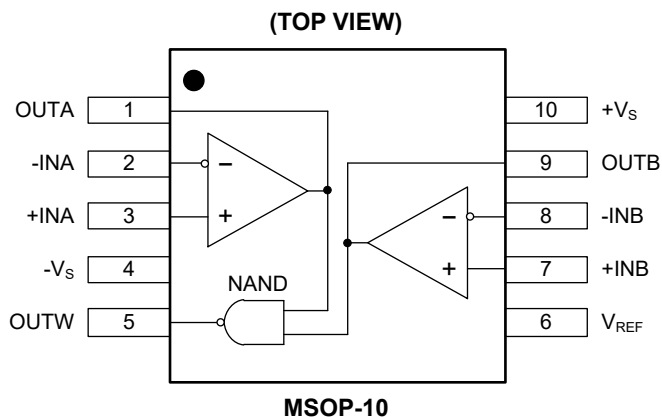

**PIN DESCRIPTION**

PIN	NAME	FUNCTION
1	OUTA	Output of Comparator A.
2	-INA	Inverting Input of Comparator A.
3	+INA	Non-Inverting Input of Comparator A.
4	- $V_S$	Negative Power Supply.
5	OUTW	Output of Window Comparator.
6	$V_{REF}$	Reference Output.
7	+INB	Non-Inverting Input of Comparator B.
8	-INB	Inverting Input of Comparator B.
9	OUTB	Output of Comparator B.
10	+ $V_S$	Positive Power Supply.

**ELECTRICAL CHARACTERISTICS**(V<sub>S</sub> = ±1.4V to ±18V, Full = -40°C to +125°C, typical values are at T<sub>A</sub> = +25°C, unless otherwise noted.)

PARAMETER	SYMBOL	CONDITIONS	TEMP	MIN	TYP	MAX	UNITS
Input Offset Voltage	V <sub>OS</sub>	V <sub>CM</sub> = 0V	+25°C		0.6	4	mV
			Full			4.5	
Input Bias Current	I <sub>B</sub>	V <sub>CM</sub> = 0V	+25°C		±20	±200	pA
Input Offset Current	I <sub>OS</sub>	V <sub>CM</sub> = 0V	+25°C		±20	±200	pA
Maximum Input Difference Bias Current	I <sub>ID</sub>	V <sub>S</sub> = ±18V, V <sub>ID</sub> = ±18V	+25°C		2.2	4	μA
			Full			5	
Input Common Mode Voltage Range <sup>(1)</sup>	V <sub>CM</sub>		Full	-V <sub>S</sub>		(+V <sub>S</sub> ) - 1.5V	V
Common Mode Rejection Ratio	CMRR	V <sub>S</sub> = ±18V, V <sub>CM</sub> = (-V <sub>S</sub> ) to (+V <sub>S</sub> ) - 1.5V	+25°C	90	116		dB
			Full	87			
Power Supply Rejection Ratio	PSRR	V <sub>S</sub> = 2.8V to 36V	+25°C	96	116		dB
			Full	93			
Output Voltage Swing from Rail	V <sub>OH</sub>	I <sub>SOURCE</sub> = 8mA, V <sub>ID</sub> = 0.2V	+25°C		370	500	mV
			Full			780	
	V <sub>OL</sub>	I <sub>SINK</sub> = 8mA, V <sub>ID</sub> = -0.2V	+25°C		210	280	
			Full			400	
Output Short-Circuit Current	I <sub>SOURCE</sub>	V <sub>OH</sub> = (+V <sub>S</sub> ) - 1.5V, V <sub>ID</sub> = 0.2V	+25°C	17	24		mA
	I <sub>SINK</sub>	V <sub>OL</sub> = (-V <sub>S</sub> ) + 1.5V, V <sub>ID</sub> = -0.2V	+25°C	25	36		
Total Supply Current	I <sub>S</sub>	I <sub>OUT</sub> = 0mA	+25°C		420	500	μA
			Full			600	
Voltage Reference	V <sub>REF</sub>	I <sub>REF</sub> = 0 to 5mA	+25°C	(-V <sub>S</sub> ) + 1.205	(-V <sub>S</sub> ) + 1.225	(-V <sub>S</sub> ) + 1.245	V

**SWITCHING CHARACTERISTICS**(At T<sub>A</sub> = +25°C, V<sub>S</sub> = ±2.5V, C<sub>L</sub> = 15pF <sup>(2)</sup>, unless otherwise noted.)

PARAMETER	SYMBOL	CONDITIONS	TEMP	MIN	TYP	MAX	UNITS
Propagation Delay (High to Low)	t <sub>PHL</sub>	Overdrive = 10mV	+25°C		85		ns
		Overdrive = 100mV	+25°C		50		
Propagation Delay (Low to High)	t <sub>PLH</sub>	Overdrive = 10mV	+25°C		95		ns
		Overdrive = 100mV	+25°C		60		
Fall Time	t <sub>FALL</sub>	Overdrive = 10mV	+25°C		12		ns
		Overdrive = 100mV	+25°C		12		
Rise Time	t <sub>RISE</sub>	Overdrive = 10mV	+25°C		12		ns
		Overdrive = 100mV	+25°C		12		

## NOTES:

- Any input voltage should not be lower than (-V<sub>S</sub>) - 0.3V. The maximum input common mode voltage is (+V<sub>S</sub>) - 1.5V, but it will not be damaged when the upper limit of the input voltage reaches 36V.
- C<sub>L</sub>: Load capacitance (jig and probe included).

TYPICAL PERFORMANCE CHARACTERISTICS

At  $T_A = +25^\circ\text{C}$ ,  $V_S = \pm 18\text{V}$  and  $C_L = 15\text{pF}$ , unless otherwise noted.

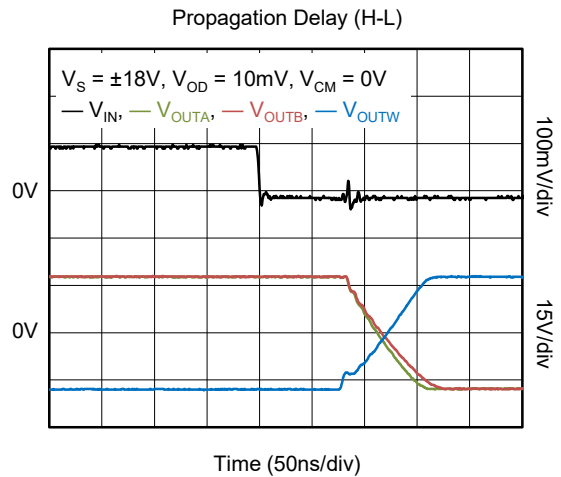
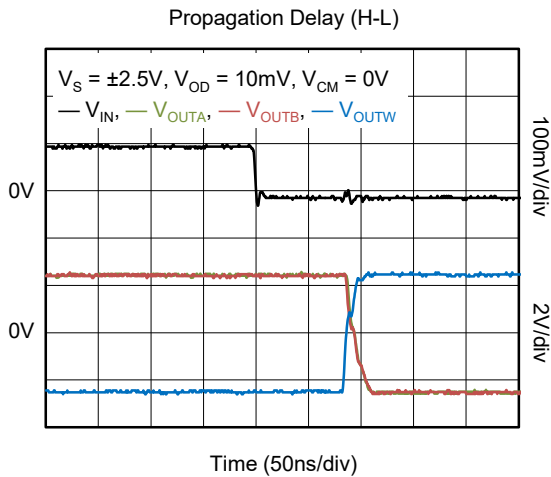
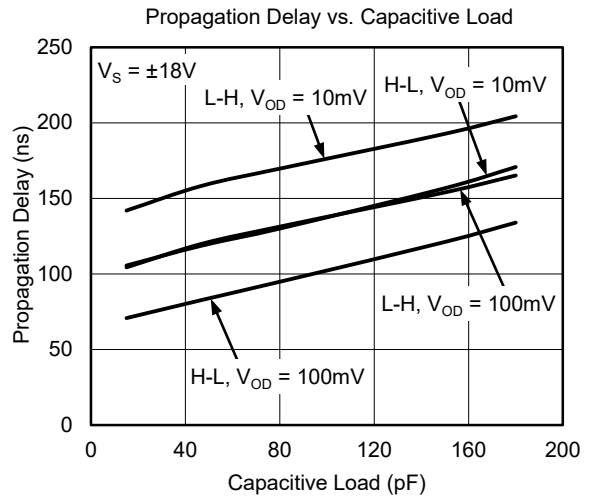
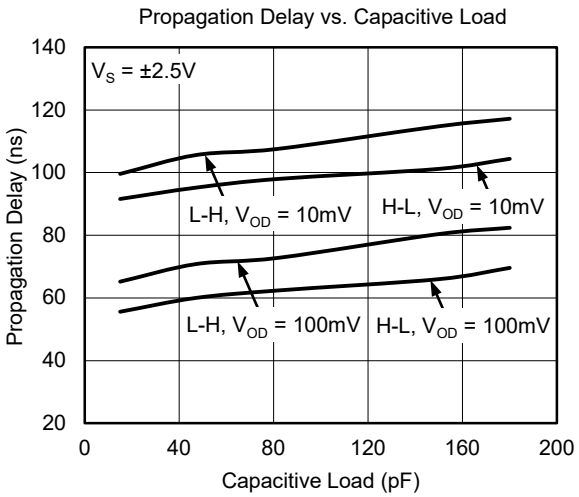
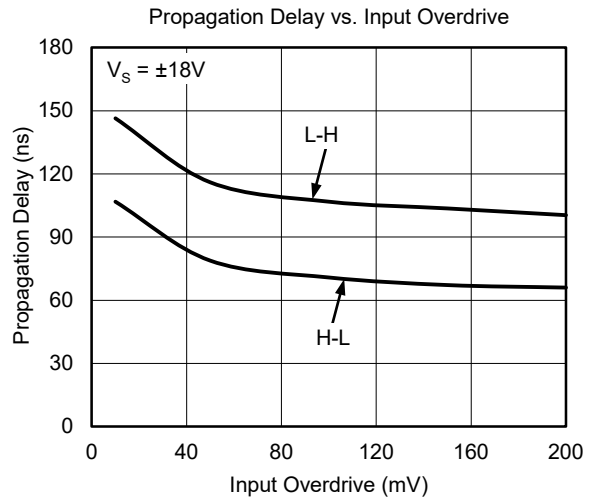
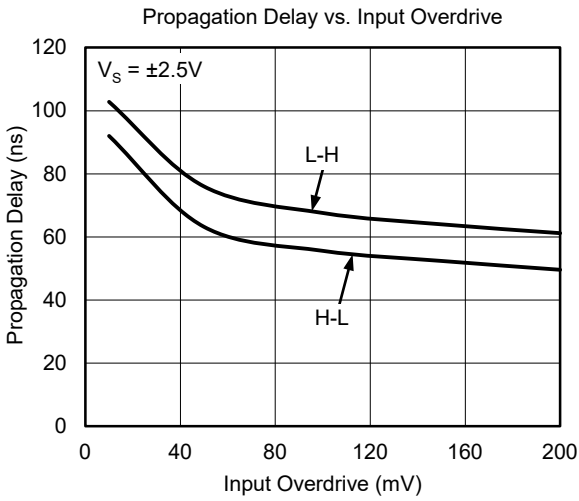

TYPICAL PERFORMANCE CHARACTERISTICS (continued)

At  $T_A = +25^\circ\text{C}$ ,  $V_S = \pm 18\text{V}$  and  $C_L = 15\text{pF}$ , unless otherwise noted.

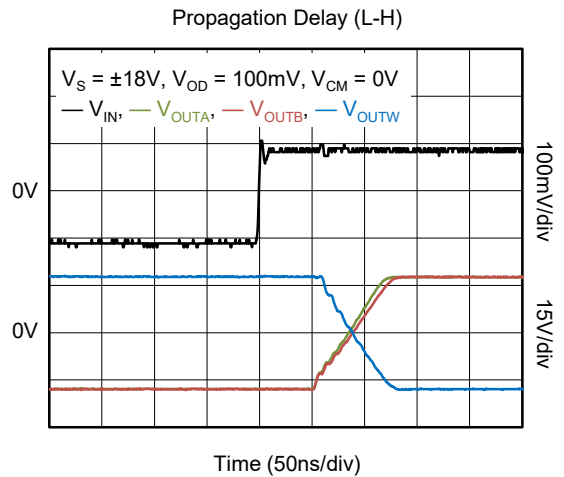
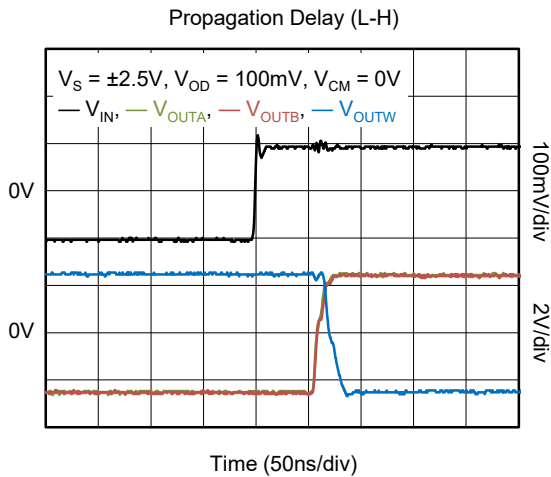
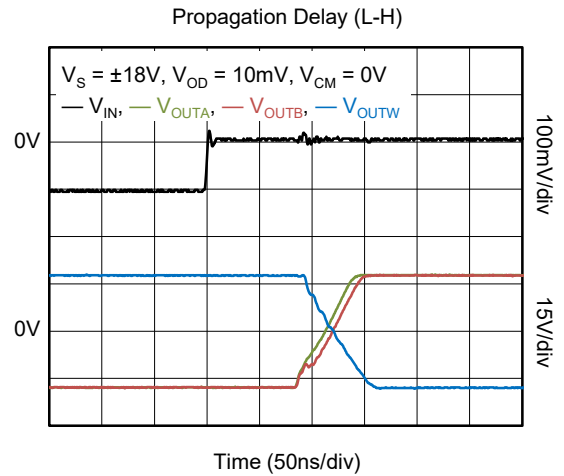
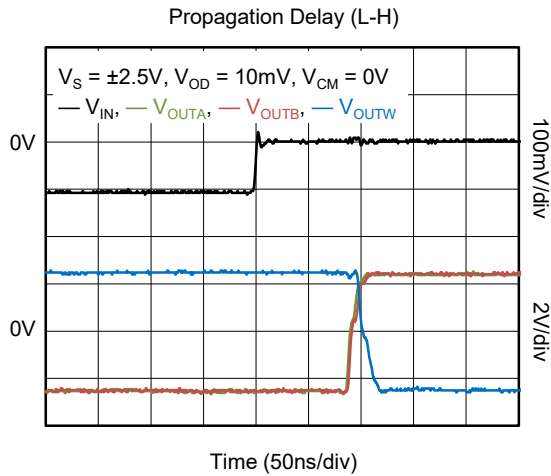
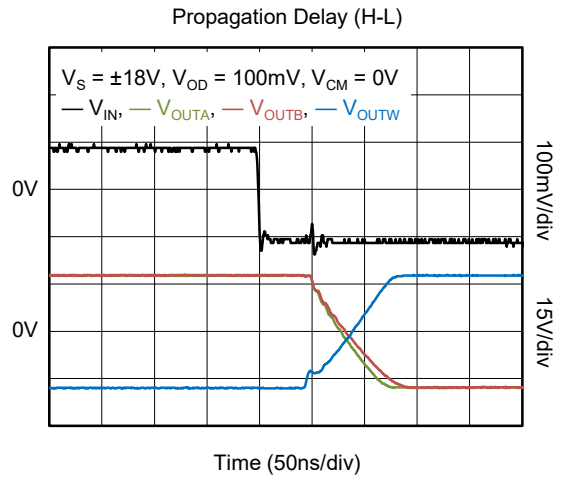
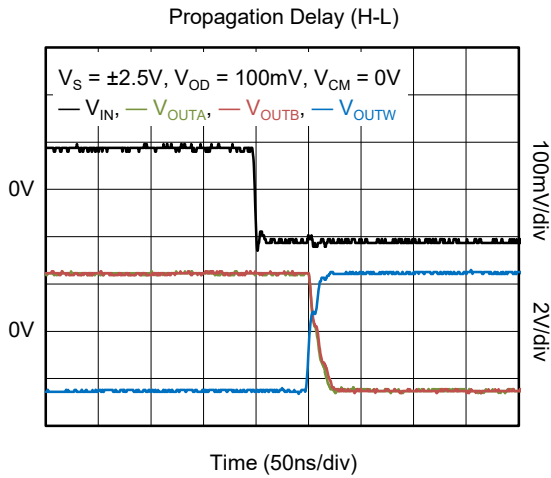

**TYPICAL PERFORMANCE CHARACTERISTICS (continued)**

At  $T_A = +25^\circ\text{C}$ ,  $V_S = \pm 18\text{V}$  and  $C_L = 15\text{pF}$ , unless otherwise noted.

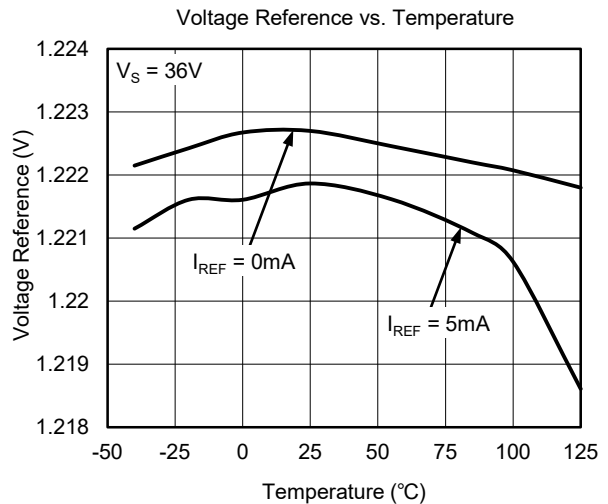
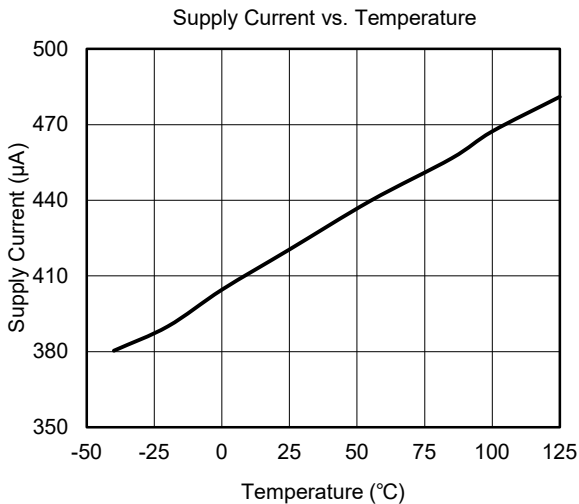
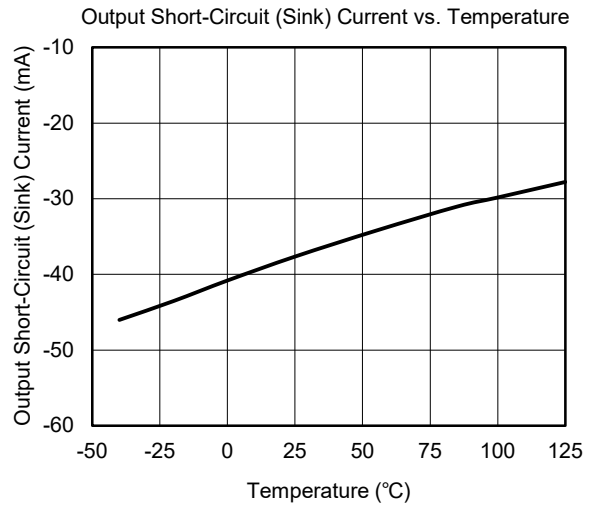
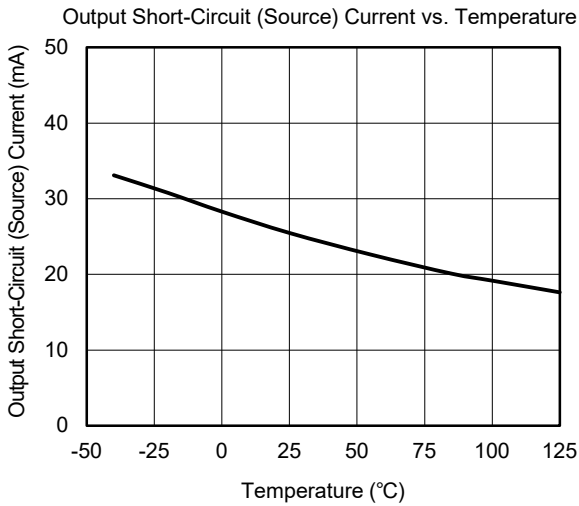
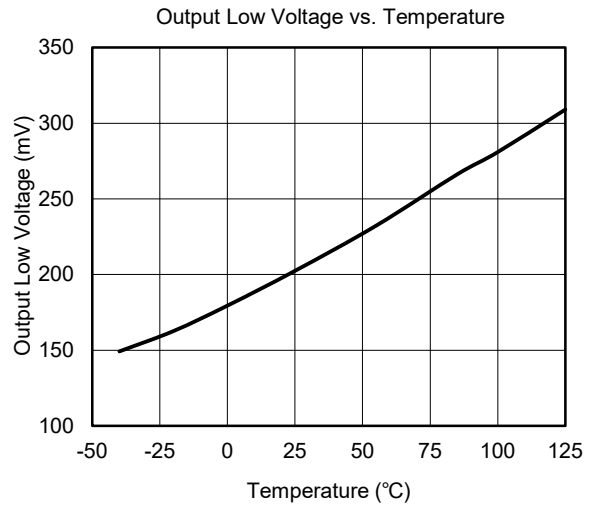
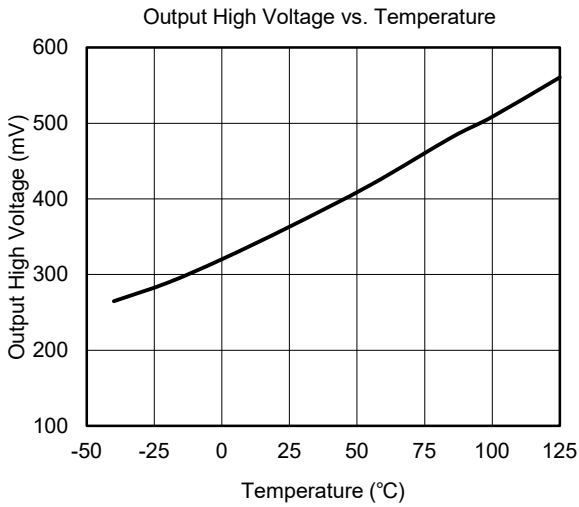

**TYPICAL PERFORMANCE CHARACTERISTICS (continued)**

At T<sub>A</sub> = +25°C, V<sub>S</sub> = ±18V and C<sub>L</sub> = 15pF, unless otherwise noted.

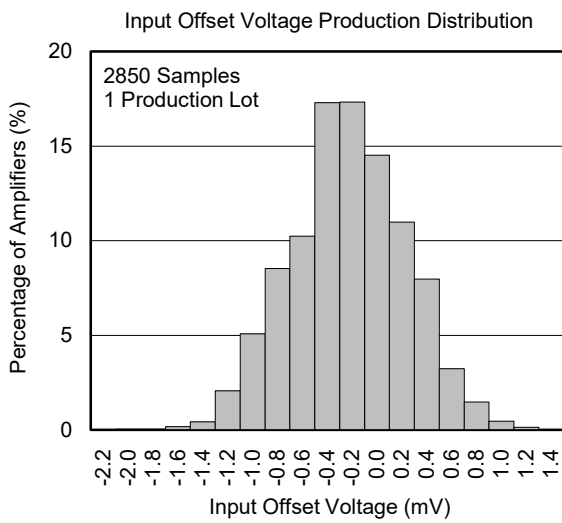



**DETAILED DESCRIPTION**

The SGM8772 is dual, high precision, low power comparator. The wide input voltage range and power supply range make the device a good choice for industrial equipment. Push-pull structure saves external pull-up resistors. The SGM8772 can be compatible with CMOS and TTL logics.

**Output Structure**

In Figure 1, the SGM8772 has a push-pull output stage. When output is changed from logic high/low to low/high, the changed sink/source current pulls/pushes output pin to logic low/high. Beginning this transition, larger sink/source current is used to create a high slew rate transit from high/low to low/high. Once the output voltage reaches  $V_{OL}/V_{OH}$ , it will reduce the sink/source current to a just right value to maintain the  $V_{OL}/V_{OH}$  static condition. This current-driven push-pull output stage will significantly reduce the power consumption in application system. OUTA, OUTB and NAND gate form the third window comparator output.

If low slew rate transition is needed in system design, adjusting the load capacitance will change the slew rate. The heavier capacitive load will slow down the output voltage transition. This feature will be used to reduce the interference generated by fast edge of transition between 1 and 0 in noise-sensitive system.

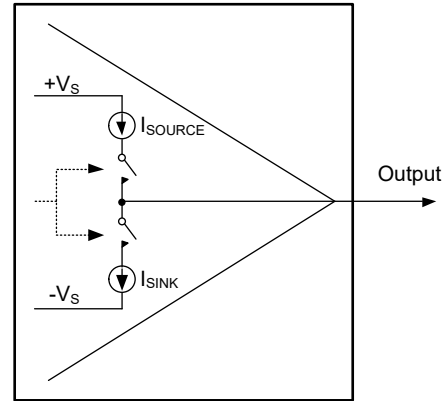

Figure 1. Push-Pull Output Structure

**APPLICATION INFORMATION**

**Window Comparator**

It's easy to design a window comparator by using SGM8772, and this design is shown in Figure 2.

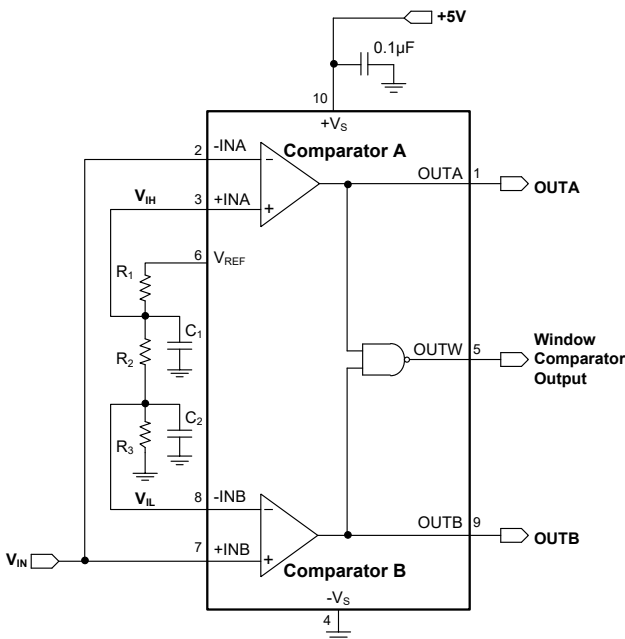

Figure 2. Window Comparator

**Layout and Bypassing**

Good power supply decoupling, layout and grounding are very important for SGM8772 to realize the full high-speed capabilities in system, following skills will be used:

- ◆ A 0.1µF to 4.7µF range ceramic capacitor is used to provide good power supply decoupling. This ceramic capacitor must be placed as close to +Vs pin as possible.
- ◆ For grounding, unbroken and low-inductance ground plane is a good choice.
- ◆ For Layout, use short PCB trace to avoid unwanted parasitic feedback around the comparator. SGM8772 must be soldered directly to the PCB and the socket is not recommended.

**REVISION HISTORY**

NOTE: Page numbers for previous revisions may differ from page numbers in the current version.

<b>OCTOBER 2023 – REV.A to REV.A.1</b>	<b>Page</b>
Updated Absolute Maximum Ratings section.....	2
Updated Recommended Operating Conditions section.....	2
Updated Pin Configuration section.....	3
Updated Pin Description section.....	3
Updated Electrical Characteristics section.....	4

<b>Changes from Original (DECEMBER 2019) to REV.A</b>	<b>Page</b>
Changed from product preview to production data.....	All

PACKAGE OUTLINE DIMENSIONS

MSOP-10

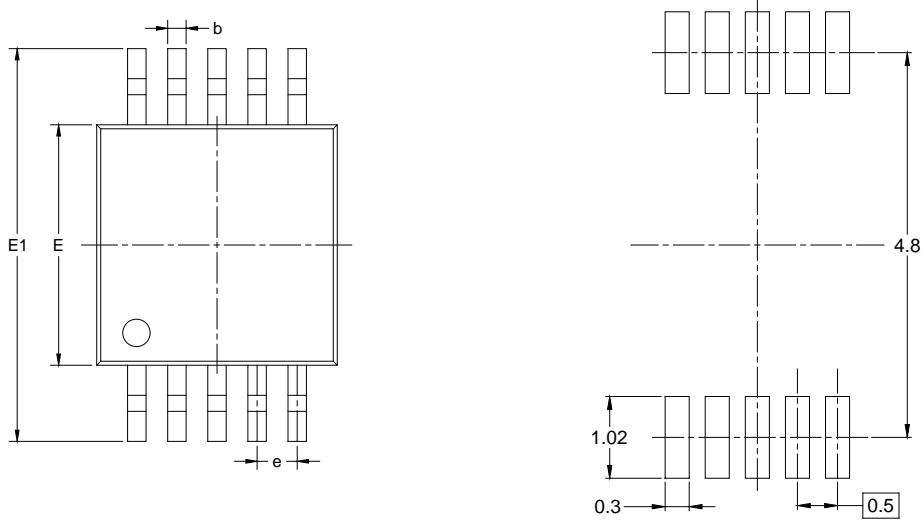

RECOMMENDED LAND PATTERN (Unit: mm)

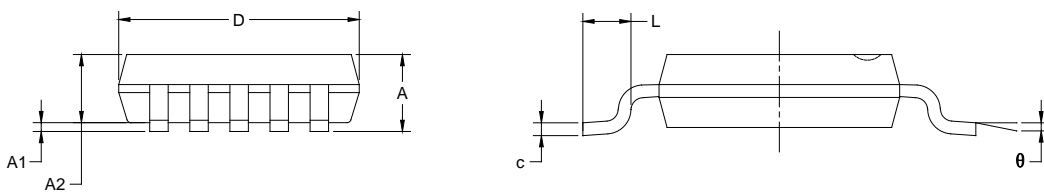

Symbol	Dimensions In Millimeters		Dimensions In Inches	
	MIN	MAX	MIN	MAX
A	0.820	1.100	0.032	0.043
A1	0.020	0.150	0.001	0.006
A2	0.750	0.950	0.030	0.037
b	0.180	0.280	0.007	0.011
c	0.090	0.230	0.004	0.009
D	2.900	3.100	0.114	0.122
E	2.900	3.100	0.114	0.122
E1	4.750	5.050	0.187	0.199
e	0.500 BSC		0.020 BSC	
L	0.400	0.800	0.016	0.031
θ	0°	6°	0°	6°

- NOTES:  
 1. Body dimensions do not include mode flash or protrusion.  
 2. This drawing is subject to change without notice.

## TAPE AND REEL INFORMATION

### REEL DIMENSIONS



### TAPE DIMENSIONS



NOTE: The picture is only for reference. Please make the object as the standard.

### KEY PARAMETER LIST OF TAPE AND REEL

Package Type	Reel Diameter	Reel Width W1 (mm)	A0 (mm)	B0 (mm)	K0 (mm)	P0 (mm)	P1 (mm)	P2 (mm)	W (mm)	Pin1 Quadrant
MSOP-10	13"	12.4	5.20	3.30	1.50	4.0	8.0	2.0	12.0	Q1

DD0001

# PACKAGE INFORMATION

## CARTON BOX DIMENSIONS



NOTE: The picture is only for reference. Please make the object as the standard.

## KEY PARAMETER LIST OF CARTON BOX

Reel Type	Length (mm)	Width (mm)	Height (mm)	Pizza/Carton
13"	386	280	370	5

DD0002