

GENERAL DESCRIPTION

The SGM2041 is an ultra-low noise, high PSRR and low dropout voltage linear regulator. It is capable of supplying 300mA output current with typical dropout voltage of only 50mV. The operating input voltage range is from 1.6V to 5.5V and output voltage range is from 0.75V to 4.35V.

Other features include logic-controlled shutdown mode, short-circuit current limit and thermal shutdown protection. The SGM2041 has automatic discharge function to quickly discharge V_{OUT} in the disabled status.

The SGM2041 is suitable for application which needs low noise and fast transient response power supply, such as power supply of camera module in smart phone, etc.

The SGM2041 is available in an ultra-thin Green WLCSP-0.64×0.64-4B-A package. It operates over an operating temperature range of -40°C to +125°C.

FEATURES

- **Operating Input Voltage Range: 1.6V to 5.5V**
- **Fixed Outputs of 0.75V, 0.8V, 1.0V, 1.1V, 1.2V, 1.5V, 1.8V, 2.5V, 2.8V, 3.0V, 3.3V, 3.6V, 4.2V, and 4.35V**
- **Ultra-Low Quiescent Current: 10µA (TYP)**
- **Low Dropout Voltage:**
50mV (TYP) at 300mA when $V_{OUT} = 2.8V$
- **Ultra-Low Noise: 9.5µV_{RMS} (TYP)**
- **High PSRR: 92dB (TYP) at 1kHz**
- **Standby Current: 0.03µA (TYP)**
- **Current Limiting and Thermal Protection**
- **Excellent Load and Line Transient Responses**
- **With Output Automatic Discharge**
- **Stable with Small Case Size Ceramic Capacitors**
- **-40°C to +125°C Operating Temperature Range**
- **Available in an Ultra-Thin Green WLCSP-0.64×0.64-4B-A Package**

APPLICATIONS

- Portable Electronic Devices
- Smoke Detectors
- IP Cameras
- Wireless LAN Devices
- Battery-Powered Equipment
- Smartphones and Tablets
- Digital Cameras and Audio Devices

TYPICAL APPLICATION

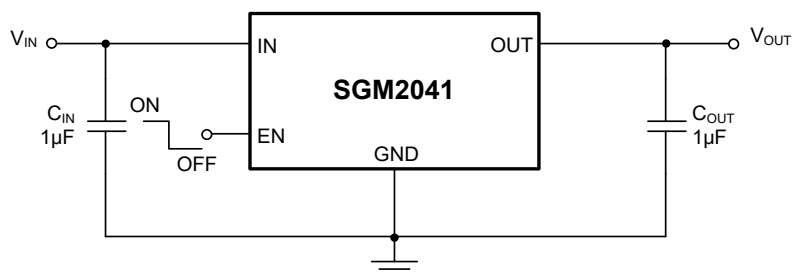

Figure 1. Typical Application Circuit

PACKAGE/ORDERING INFORMATION

MODEL	PACKAGE DESCRIPTION	SPECIFIED TEMPERATURE RANGE	ORDERING NUMBER	PACKAGE MARKING	PACKING OPTION
SGM2041-0.75	WLCSP-0.64×0.64-4B-A	-40°C to +125°C	SGM2041-0.75XG/TR	M4	Tape and Reel, 5000
SGM2041-0.8	WLCSP-0.64×0.64-4B-A	-40°C to +125°C	SGM2041-0.8XG/TR	M5	Tape and Reel, 5000
SGM2041-1.0	WLCSP-0.64×0.64-4B-A	-40°C to +125°C	SGM2041-1.0XG/TR	M6	Tape and Reel, 5000
SGM2041-1.1	WLCSP-0.64×0.64-4B-A	-40°C to +125°C	SGM2041-1.1XG/TR	M8	Tape and Reel, 5000
SGM2041-1.2	WLCSP-0.64×0.64-4B-A	-40°C to +125°C	SGM2041-1.2XG/TR	Y9	Tape and Reel, 5000
SGM2041-1.5	WLCSP-0.64×0.64-4B-A	-40°C to +125°C	SGM2041-1.5XG/TR	Y8	Tape and Reel, 5000
SGM2041-1.8	WLCSP-0.64×0.64-4B-A	-40°C to +125°C	SGM2041-1.8XG/TR	Y7	Tape and Reel, 5000
SGM2041-2.5	WLCSP-0.64×0.64-4B-A	-40°C to +125°C	SGM2041-2.5XG/TR	YA	Tape and Reel, 5000
SGM2041-2.8	WLCSP-0.64×0.64-4B-A	-40°C to +125°C	SGM2041-2.8XG/TR	I8	Tape and Reel, 5000
SGM2041-3.0	WLCSP-0.64×0.64-4B-A	-40°C to +125°C	SGM2041-3.0XG/TR	YB	Tape and Reel, 5000
SGM2041-3.3	WLCSP-0.64×0.64-4B-A	-40°C to +125°C	SGM2041-3.3XG/TR	YC	Tape and Reel, 5000
SGM2041-3.6	WLCSP-0.64×0.64-4B-A	-40°C to +125°C	SGM2041-3.6XG/TR	YD	Tape and Reel, 5000
SGM2041-4.2	WLCSP-0.64×0.64-4B-A	-40°C to +125°C	SGM2041-4.2XG/TR	YE	Tape and Reel, 5000
SGM2041-4.35	WLCSP-0.64×0.64-4B-A	-40°C to +125°C	SGM2041-4.35XG/TR	M9	Tape and Reel, 5000

MARKING INFORMATION

YY

Serial Number

Green (RoHS & HSF): SG Micro Corp defines "Green" to mean Pb-Free (RoHS compatible) and free of halogen substances. If you have additional comments or questions, please contact your SGMICRO representative directly.

ABSOLUTE MAXIMUM RATINGS

IN to GND	-0.3V to 6V
OUT to GND	-0.3V to (V _{IN} + 0.3V)
EN to GND.....	-0.3V to 6V
Package Thermal Resistance	
WLCSP-0.64×0.64-4B-A, θ _{JA}	285°C/W
WLCSP-0.64×0.64-4B-A, θ _{JB}	50°C/W
WLCSP-0.64×0.64-4B-A, θ _{JC}	116°C/W
Junction Temperature.....	+150°C
Storage Temperature Range	-65°C to +150°C
Lead Temperature (Soldering, 10s).....	+260°C
ESD Susceptibility	
HBM.....	8000V
CDM	1000V

RECOMMENDED OPERATING CONDITIONS

Input Voltage Range	1.6V to 5.5V
Enable Input Voltage Range	0V to 5.5V
Input Effective Capacitance, C _{IN}	0.1µF (MIN)
Output Effective Capacitance, C _{OUT}	0.5µF to 10µF
Operating Junction Temperature Range.....	-40°C to +125°C

OVERSTRESS CAUTION

Stresses beyond those listed in Absolute Maximum Ratings may cause permanent damage to the device. Exposure to absolute maximum rating conditions for extended periods may affect reliability. Functional operation of the device at any conditions beyond those indicated in the Recommended Operating Conditions section is not implied.

ESD SENSITIVITY CAUTION

This integrated circuit can be damaged if ESD protections are not considered carefully. SGMICRO recommends that all integrated circuits be handled with appropriate precautions. Failure to observe proper handling and installation procedures can cause damage. ESD damage can range from subtle performance degradation to complete device failure. Precision integrated circuits may be more susceptible to damage because even small parametric changes could cause the device not to meet the published specifications.

DISCLAIMER

SG Micro Corp reserves the right to make any change in circuit design, or specifications without prior notice.

PIN CONFIGURATION

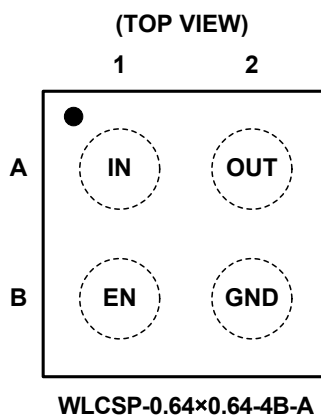

PIN DESCRIPTION

PIN	NAME	FUNCTION
A1	IN	Input Voltage Supply Pin. It is recommended to use a 1 μ F or larger ceramic capacitor from IN pin to ground. This ceramic capacitor should be placed as close as possible to IN pin.
A2	OUT	Regulated Output Pin. It is recommended to use a ceramic capacitor with effective capacitance in the range of 0.5 μ F to 10 μ F to get good power supply decoupling. This ceramic capacitor should be placed as close as possible to OUT pin.
B1	EN	Enable Pin. Drive EN high to turn on the regulator. Drive EN low to turn off the regulator. The EN pin has an internal 0.03 μ A pull-down current source which ensures that the device is turned off when the EN pin is floated. This pin must be connected to IN pin if enable functionality is not used.
B2	GND	Ground.

ELECTRICAL CHARACTERISTICS

($V_{IN} = V_{OUT(NOM)} + 1V$, $V_{EN} = V_{IN}$, $C_{IN} = C_{OUT} = 1\mu F$, $T_J = -40^\circ C$ to $+125^\circ C$, typical values are at $T_J = +25^\circ C$, unless otherwise noted.)

PARAMETER	SYMBOL	CONDITIONS		MIN	TYP	MAX	UNITS
Input Voltage Range	V_{IN}			1.6		5.5	V
Output Voltage Accuracy	V_{OUT}	$V_{IN} = (V_{OUT(NOM)} + 1V)$ to 5.5V, $I_{OUT} = 1mA$, $T_J = +25^\circ C$		-1		1	%
		$V_{IN} = (V_{OUT(NOM)} + 1V)$ to 5.5V, $I_{OUT} = 1mA$ to 300mA		-2.5		2.5	
Line Regulation	ΔV_{LNR}	$V_{IN} = (V_{OUT(NOM)} + 1V)$ to 5.5V, $I_{OUT} = 1mA$			0.05	2	mV
Load Regulation	$\Delta V_{LDR}/V_{OUT}$	$I_{OUT} = 1mA$ to 300mA			0.4	5	mV/V
Operating Supply Current	I_{GND}	$I_{OUT} = 0mA$			10	35	μA
		$I_{OUT} = 300mA$			1250	1600	
Dropout Voltage ⁽¹⁾	V_{DROP}	$I_{OUT} = 300mA$	$V_{OUT(NOM)} = 1.8V$		80	130	mV
			$V_{OUT(NOM)} = 2.8V$		50	110	
Output Current Limit	I_{LIMIT}	$V_{OUT} = 90\% \times V_{OUT(NOM)}$	$T_J = -20^\circ C$ to $+125^\circ C$	300	580		mA
			$T_J = -40^\circ C$ to $+125^\circ C$	260	580		
Short-Circuit Current	I_{SHORT}	$V_{OUT} = 0V$			360		mA
Power Supply Rejection Ratio	PSRR	$I_{OUT} = 20mA$	$f = 100Hz$		90		dB
			$f = 1kHz$		92		
			$f = 10kHz$		80		
			$f = 100kHz$		55		
Output Voltage Noise	e_n	$f = 10Hz$ to 100kHz	$I_{OUT} = 1mA$		9.5		μV_{RMS}
			$I_{OUT} = 300mA$		8.2		
Output Discharge Resistance	R_{DIS}	$V_{EN} = 0V$, $V_{OUT} = 0.2V$, $V_{IN} = 3.3V$			255		Ω
EN Pin Threshold Voltage	V_{IH}	$V_{IN} = 1.6V$ to 5.5V, V_{EN} rising until the output is enabled		1			V
	V_{IL}	$V_{IN} = 1.6V$ to 5.5V, V_{EN} falling until the output is disabled				0.6	
EN Pull-Down Current	I_{EN}	$V_{EN} = V_{IN} = 5.5V$			0.2	1	μA
		$V_{EN} = 0V$, $V_{IN} = 5.5V$			0.001	1	
Shutdown Current	I_{SHDN}	$V_{EN} = 0V$, $V_{IN} = 5.5V$			0.03	2	μA
Turn-On Time	t_{ON}	From $V_{EN} > V_{IH}$ to $V_{OUT} = 90\% \times V_{OUT(NOM)}$			120	240	μs
Thermal Shutdown Temperature	T_{SHDN}				160		$^\circ C$
Thermal Shutdown Hysteresis	ΔT_{SHDN}				20		$^\circ C$

NOTE:

1. The dropout voltage is defined as the difference between V_{IN} and V_{OUT} when V_{OUT} falls to $(V_{OUT(NOM)} - 50mV)$.

TYPICAL PERFORMANCE CHARACTERISTICS

$T_J = +25^\circ\text{C}$, $V_{IN} = V_{OUT(NOM)} + 1\text{V}$, $V_{EN} = V_{IN}$, $C_{IN} = C_{OUT} = 1\mu\text{F}$, unless otherwise noted.

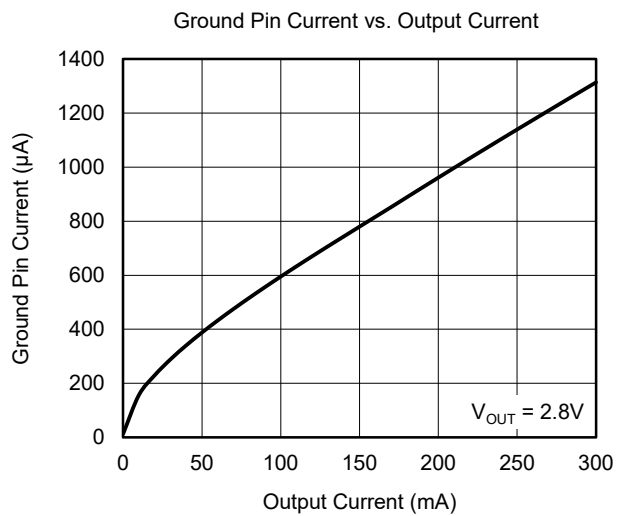
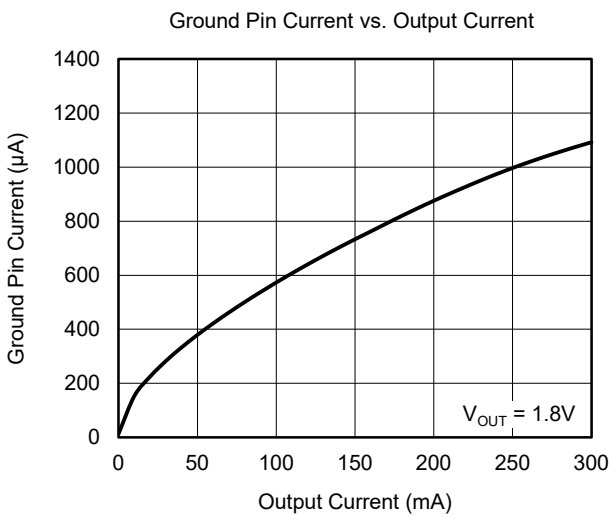
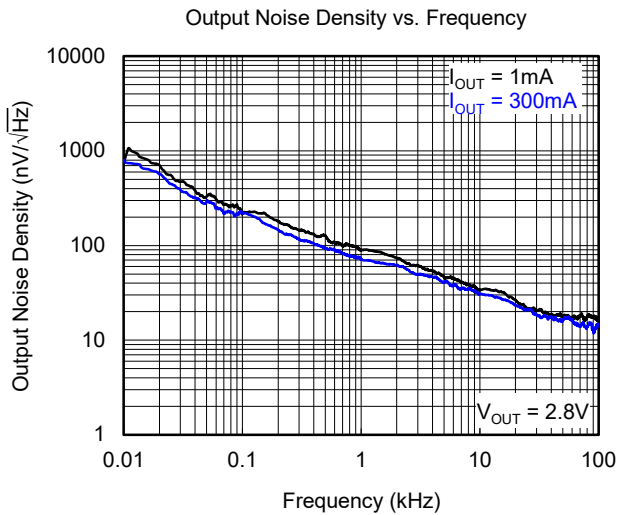
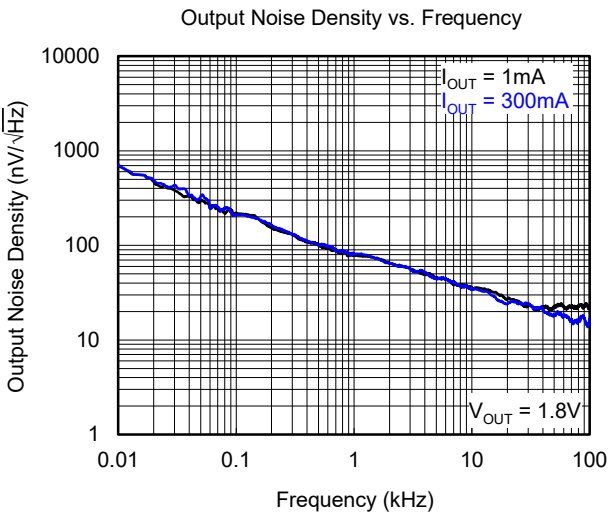
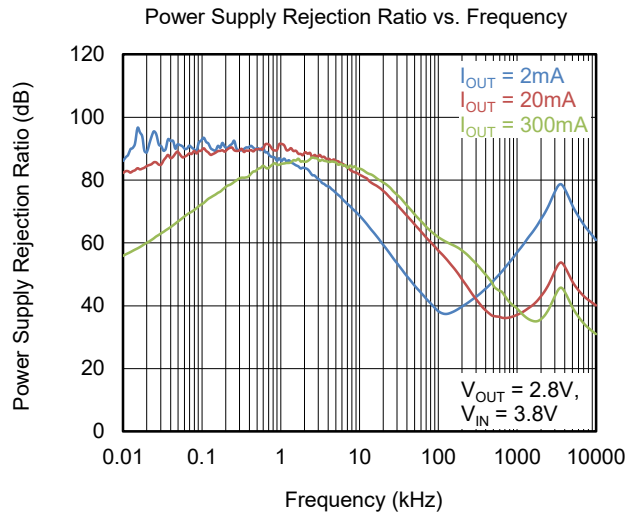
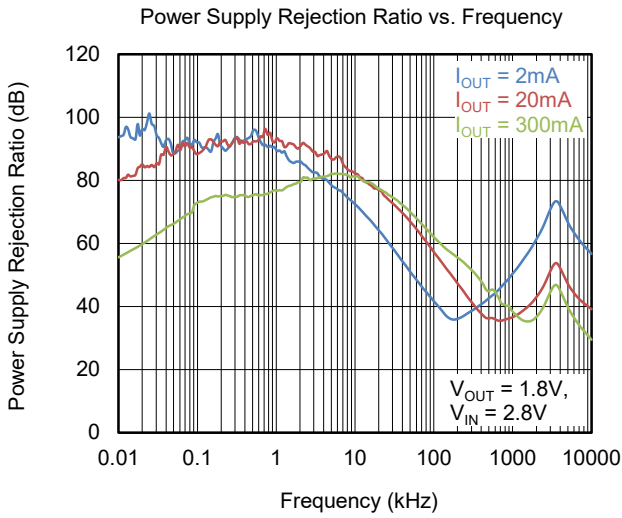

TYPICAL PERFORMANCE CHARACTERISTICS (continued)

$T_J = +25^\circ\text{C}$, $V_{IN} = V_{OUT(NOM)} + 1\text{V}$, $V_{EN} = V_{IN}$, $C_{IN} = C_{OUT} = 1\mu\text{F}$, unless otherwise noted.

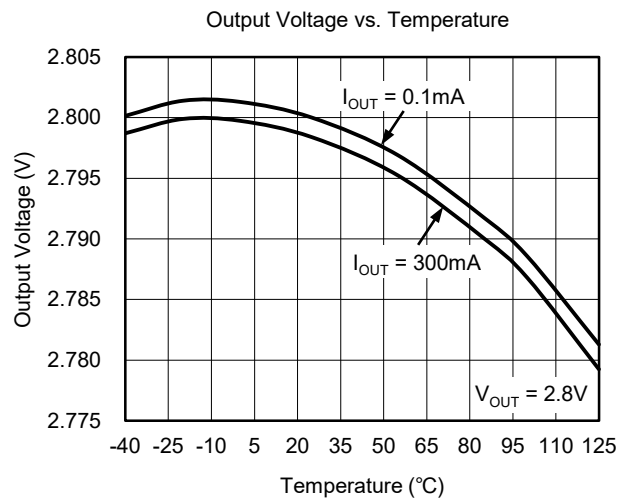
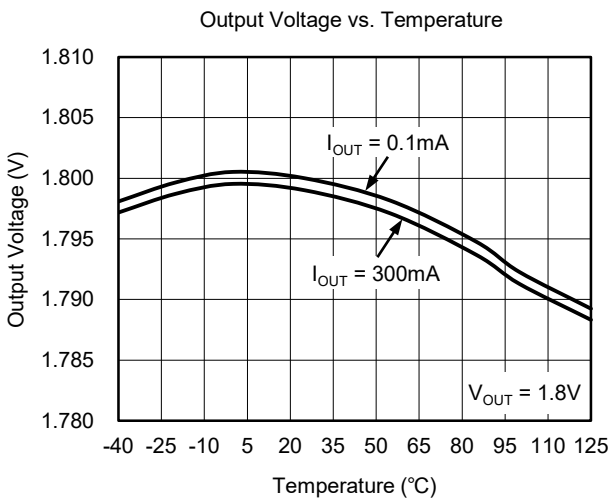
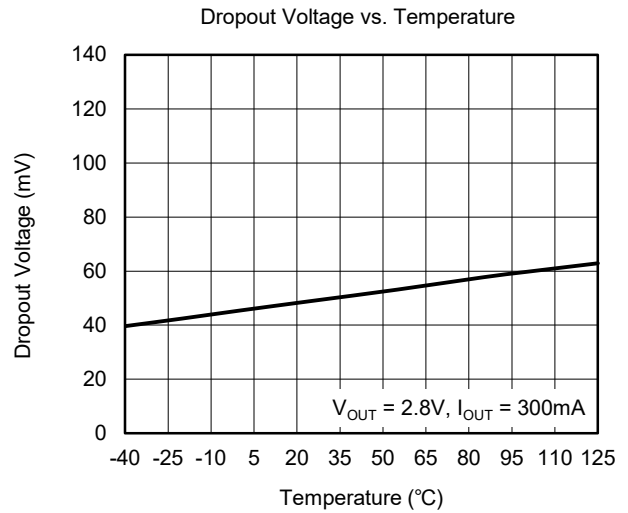
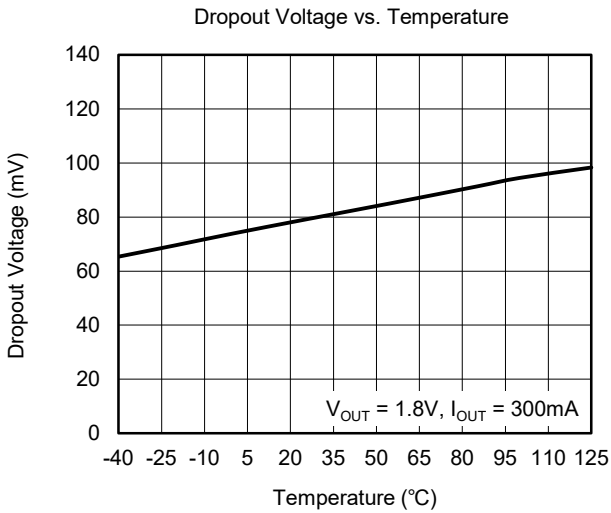
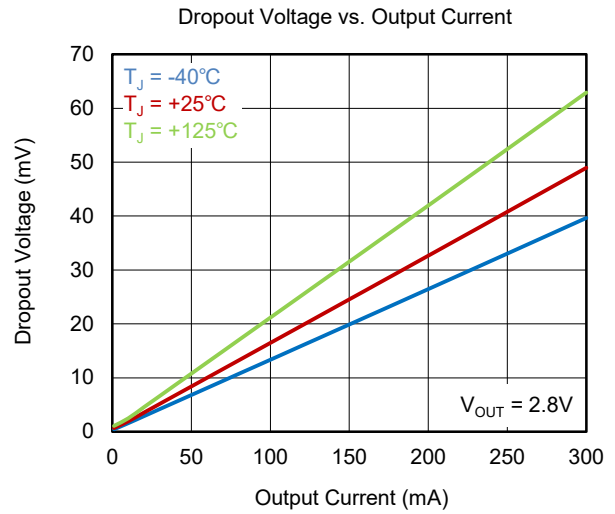
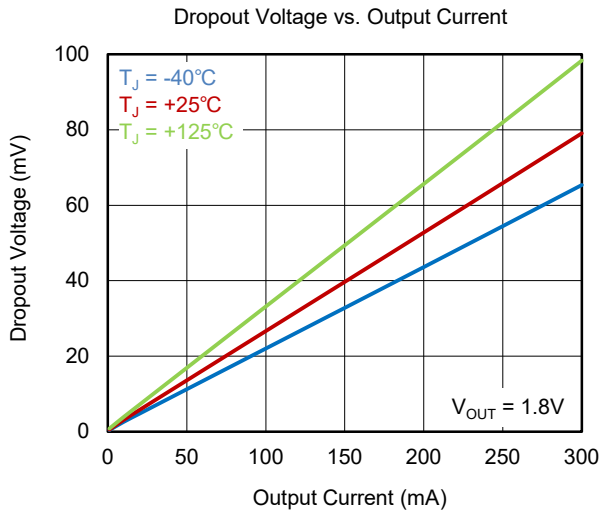

TYPICAL PERFORMANCE CHARACTERISTICS (continued)

$T_J = +25^\circ\text{C}$, $V_{IN} = V_{OUT(NOM)} + 1\text{V}$, $V_{EN} = V_{IN}$, $C_{IN} = C_{OUT} = 1\mu\text{F}$, unless otherwise noted.

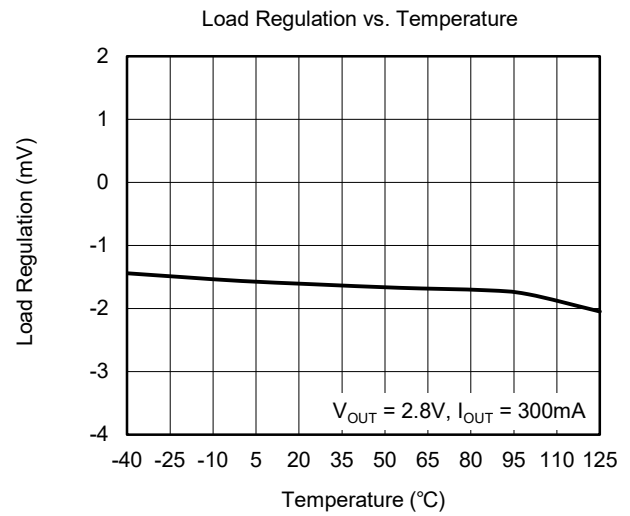
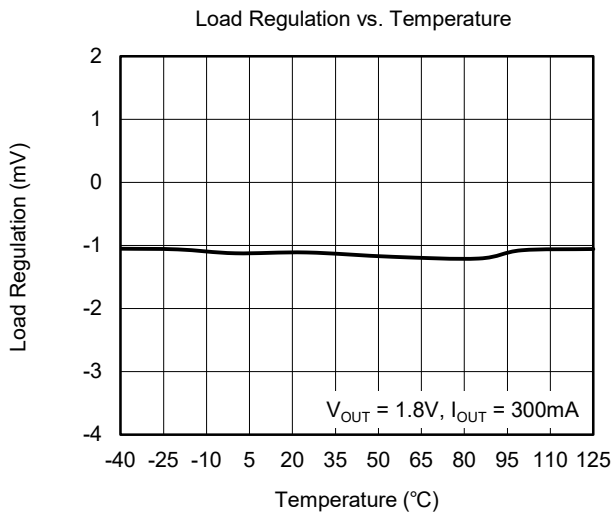

TYPICAL PERFORMANCE CHARACTERISTICS (continued)

$T_J = +25^\circ\text{C}$, $V_{IN} = V_{OUT(NOM)} + 1\text{V}$, $V_{EN} = V_{IN}$, $C_{IN} = C_{OUT} = 1\mu\text{F}$, unless otherwise noted.

Enable Turn-On Response

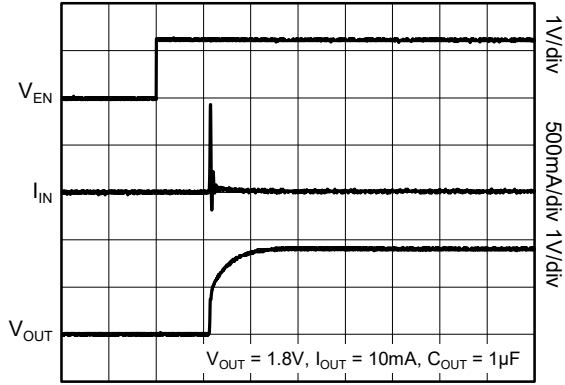

Time (50 μs /div)

Enable Turn-On Response

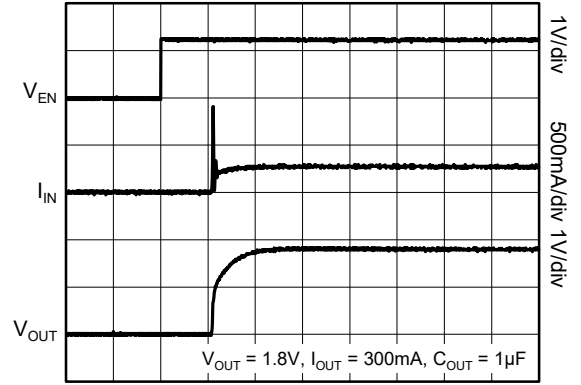

Time (50 μs /div)

Enable Turn-On Response

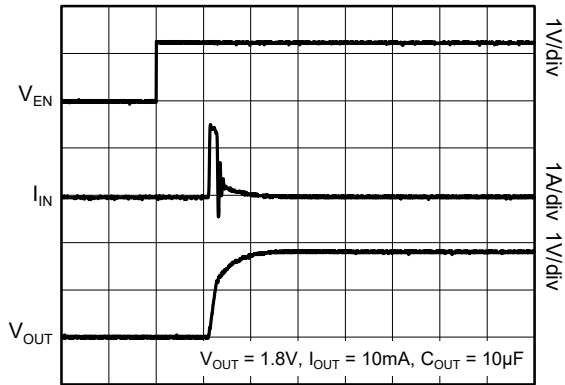

Time (50 μs /div)

Enable Turn-On Response

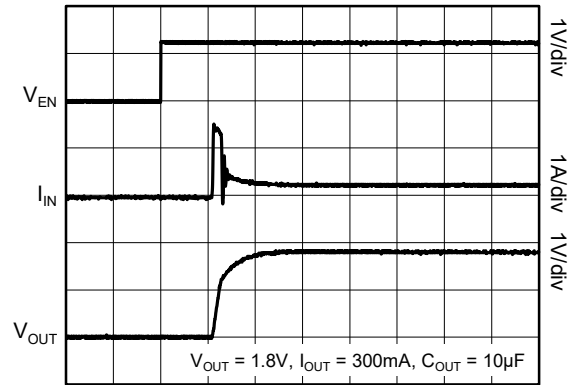

Time (50 μs /div)

Enable Turn-Off Response

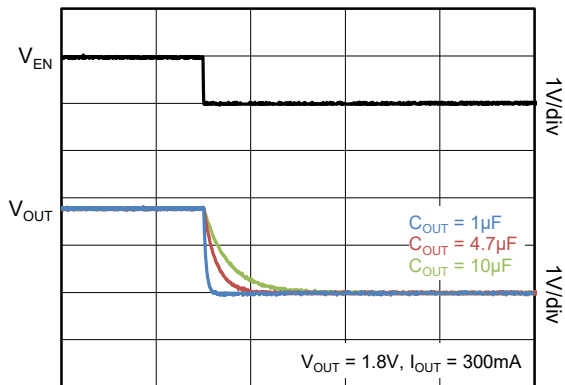

Time (200 μs /div)

TYPICAL PERFORMANCE CHARACTERISTICS (continued)

$T_J = +25^\circ\text{C}$, $V_{IN} = V_{OUT(NOM)} + 1\text{V}$, $V_{EN} = V_{IN}$, $C_{IN} = C_{OUT} = 1\mu\text{F}$, unless otherwise noted.

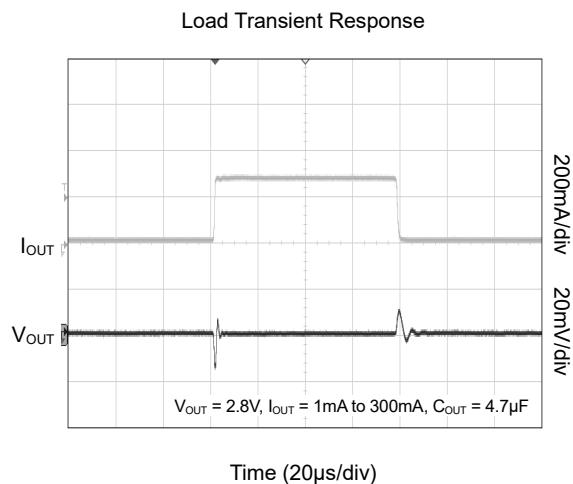
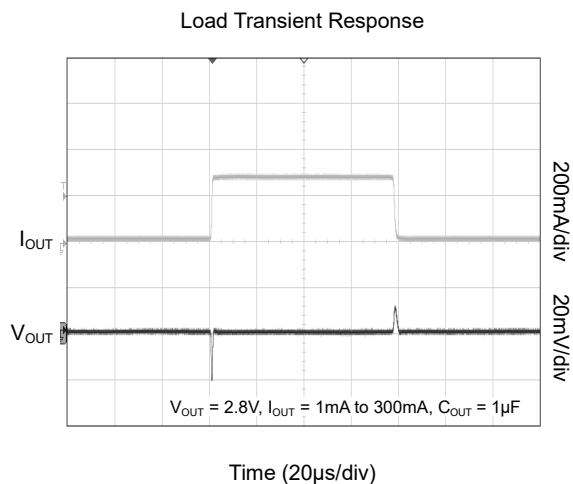
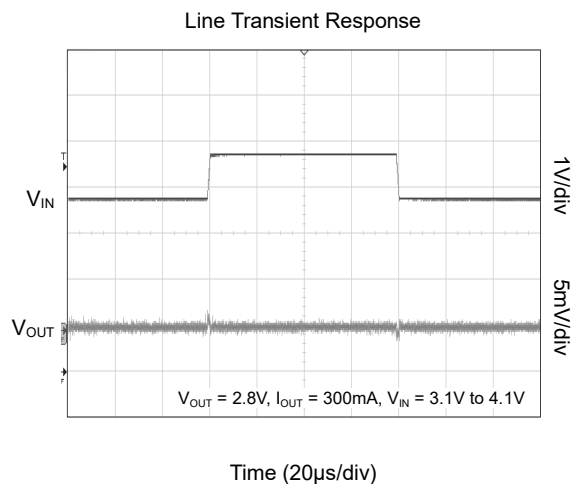
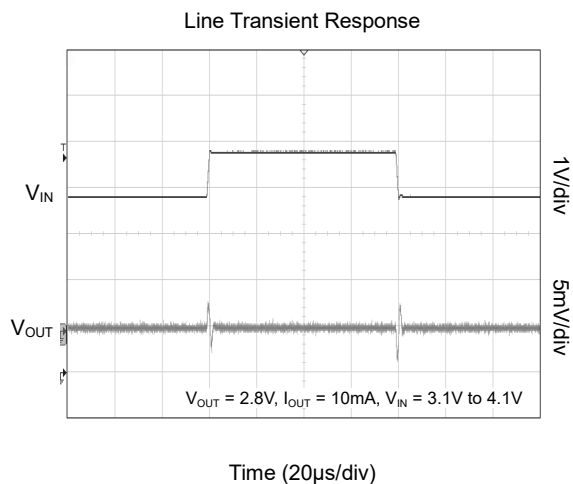
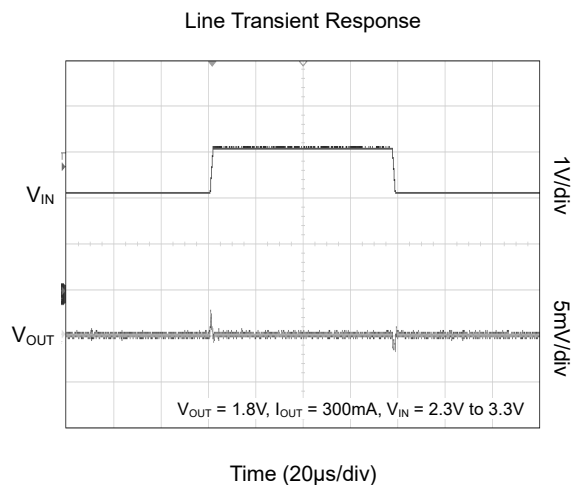
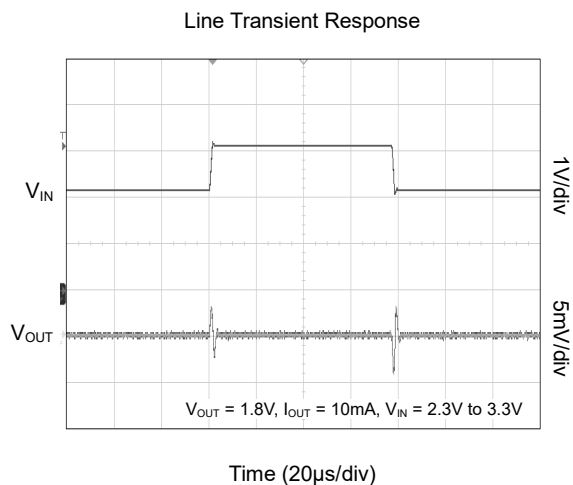

FUNCTIONAL BLOCK DIAGRAM

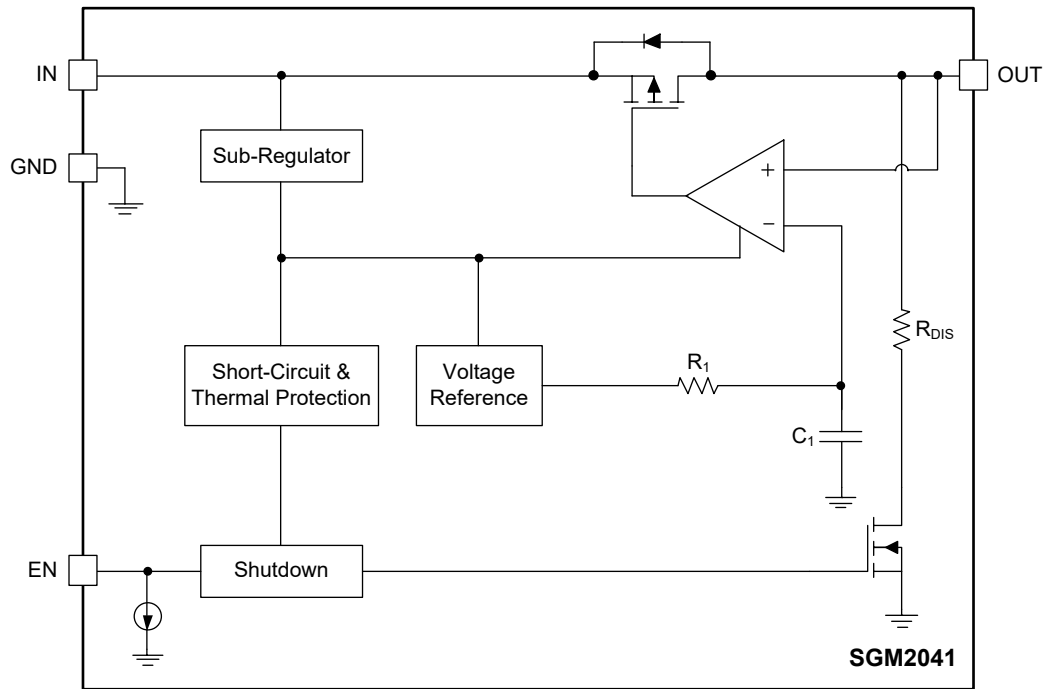

Figure 2. Block Diagram

APPLICATION INFORMATION

The SGM2041 is an ultra-low noise and low dropout LDO and provides 300mA output current. These features make the device a reliable solution to solve many challenging problems in the generation of clean and accurate power supply. The high performance also makes the SGM2041 useful in a variety of applications. The SGM2041 provides the protection function for output overload, output short-circuit condition and overheating.

The SGM2041 provides an EN pin as an external chip enable control to enable/disable the device. When the regulator is in shutdown state, the shutdown current consumes as low as 0.03 μ A (TYP).

Input Capacitor Selection (C_{IN})

The input decoupling capacitor should be placed as close as possible to the IN pin for ensuring the device stability. 1 μ F or larger X7R or X5R ceramic capacitor is selected to get good dynamic performance.

When V_{IN} is required to provide large current instantaneously, a large effective input capacitor is required. Multiple input capacitors can limit the input tracking inductance. Adding more input capacitors is available to restrict the ringing and to keep it below the device absolute maximum ratings.

Output Capacitor Selection (C_{OUT})

The output decoupling capacitor should be placed as close as possible to the OUT pin. 1 μ F or larger X7R or X5R ceramic capacitor is selected to get good dynamic performance. The minimum effective capacitance of C_{OUT} that SGM2041 can remain stable is 0.5 μ F. For ceramic capacitor, temperature, DC bias and package size will change the effective capacitance, so enough margin of C_{OUT} must be considered in design. Additionally, C_{OUT} with larger capacitance and lower ESR will help increase the high frequency PSRR and improve the load transient response.

Enable Control

The EN pin of the SGM2041 is used to enable/disable its device and to deactivate/activate the output automatic discharge function.

When the EN pin voltage is lower than 0.6V, the device is in shutdown state, there is no current flowing from IN to OUT pins. In this state, the automatic discharge transistor is active to discharge the output voltage through a 255 Ω (TYP) resistor.

When the EN pin voltage is higher than 1V, the device is in active state, the input voltage is regulated to the output voltage and the automatic discharge transistor is turned off.

The EN pin is pulled down by internal 0.03 μ A (TYP) current source when the EN pin is floated. This current source will ensure the SGM2041 in shutdown state and reduce the power dissipation in system.

Reverse Current

The pass transistor has an inherent body diode which will be forward biased in the case when $V_{OUT} > (V_{IN} + 0.3V)$. If extended reverse voltage operation is anticipated, external limiting might be appropriate.

Negatively Biased Output

When the output is negative voltage, the chip may not start up due to parasitic effects. Ensure that the output is greater than -0.3V under all conditions. If excessive negatively biased output is expected in the application, a Schottky diode can be added between the OUT pin and GND pin.

Output Current Limit and Short-Circuit Protection

When overload events happen, the output current is internally limited to 580mA (TYP). When the OUT pin is shorted to ground, the short-circuit protection will limit the output current to 360mA (TYP).

Thermal Shutdown

The SGM2041 can detect the temperature of die. When the die temperature exceeds the threshold value of thermal shutdown, the SGM2041 will be in shutdown state and it will remain in this state until the die temperature decreases to +140°C.

APPLICATION INFORMATION (continued)

Power Dissipation (P_D)

Thermal protection limits power dissipation in the SGM2041. When power dissipation on pass element ($P_D = (V_{IN} - V_{OUT}) \times I_{OUT}$) is too much and the operating junction temperature exceeds +160°C, the OTP circuit starts the thermal shutdown function and turns the pass element off.

Therefore, thermal analysis for the chosen application is important to guarantee reliable performance over all conditions. To guarantee reliable operation, the junction temperature of the SGM2041 must not exceed +125°C.

The maximum allowable power dissipation depends on the thermal resistance of the IC package, the PCB layout, the rate of surrounding airflow, and the difference between the junction temperature and ambient temperature. The maximum power dissipation can be approximated using the following equation:

$$P_{D(MAX)} = (T_{J(MAX)} - T_A) / \theta_{JA} \quad (1)$$

where $T_{J(MAX)}$ is the maximum junction temperature, T_A is the ambient temperature, and θ_{JA} is the junction -to-ambient thermal resistance.

REVISION HISTORY

NOTE: Page numbers for previous revisions may differ from page numbers in the current version.

OCTOBER 2021 – REV.A to REV.A.1		Page
Updated Electrical Characteristics section	5	5
Changes from Original (SEPTEMBER 2021) to REV.A		Page
Changed from product preview to production data	All	All

PACKAGE OUTLINE DIMENSIONS

WLCSP-0.64x0.64-4B-A

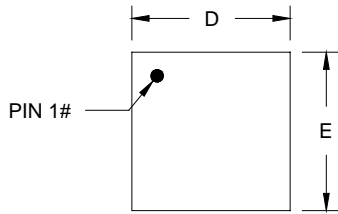

TOP VIEW

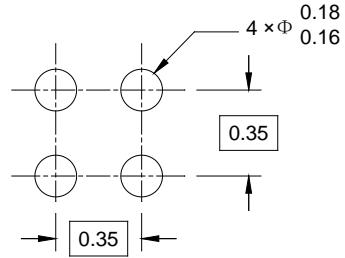

RECOMMENDED LAND PATTERN (Unit: mm)

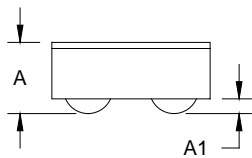

SIDE VIEW

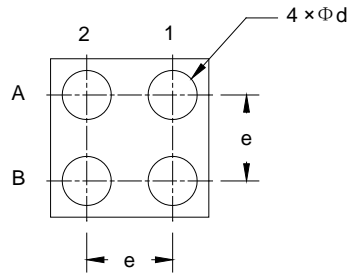

BOTTOM VIEW

Symbol	Dimensions In Millimeters		
	MIN	MOD	MAX
A	0.262	0.290	0.318
A1	0.050	0.060	0.070
D	0.620	0.645	0.670
E	0.620	0.645	0.670
d	0.190	0.200	0.210
e	0.350 BSC		

NOTE: This drawing is subject to change without notice.

PACKAGE INFORMATION

TAPE AND REEL INFORMATION

REEL DIMENSIONS



TAPE DIMENSIONS



NOTE: The picture is only for reference. Please make the object as the standard.

KEY PARAMETER LIST OF TAPE AND REEL

Package Type	Reel Diameter	Reel Width W1 (mm)	A0 (mm)	B0 (mm)	K0 (mm)	P0 (mm)	P1 (mm)	P2 (mm)	W (mm)	Pin1 Quadrant
WLCSP-0.64×0.64-4B-A	7"	9.5	0.74	0.74	0.37	4.0	4.0	2.0	8.0	Q1

000001

PACKAGE INFORMATION

CARTON BOX DIMENSIONS



NOTE: The picture is only for reference. Please make the object as the standard.

KEY PARAMETER LIST OF CARTON BOX

Reel Type	Length (mm)	Width (mm)	Height (mm)	Pizza/Carton
7" (Option)	368	227	224	8
7"	442	410	224	18

DD0002