

GENERAL DESCRIPTION

The SGM05CB1A4 is a low capacitance ESD protection device designed to protect circuits from electrostatic discharge.

FEATURES

- **High ESD Withstand Voltage:**
IEC 61000-4-2: $\pm 30\text{kV}$ (Air)
IEC 61000-4-2: $\pm 30\text{kV}$ (Contact)
- **Rated Peak Pulse Current: 4A**
- **2.7pF (TYP) Channel Input Capacitance**
- **Low Profile Packages: UTDFN-1x0.6-2L, XTDFN-0.6x0.3-2L**
- **Working Voltage: 5.0V and below**

APPLICATIONS

Cellular Handsets & Accessories
Computers and Peripherals
Audio and Video Equipment
SIM Card Protection
Portable Electronics
10/100Mbit/s Ethernet

ABSOLUTE MAXIMUM RATINGS

PARAMETER	SYMBOL	VALUE	UNITS
Peak Pulse Current ($t_p: 8/20\mu\text{s}$)	I_{PPM}	4	A
ESD IEC 61000-4-2 (Air)	V_{ESD}	± 30	kV
ESD IEC 61000-4-2 (Contact)		± 30	
Operating Temperature Range	T_{OP}	-40 to +125	$^{\circ}\text{C}$
Storage Temperature Range	T_{STG}	-55 to +150	$^{\circ}\text{C}$
Lead Temperature (Soldering, 10s)		+260	$^{\circ}\text{C}$

Stresses beyond those listed in Absolute Maximum Ratings may cause permanent damage to the device. Exposure to absolute maximum rating conditions for extended periods may affect reliability.

PRODUCT SUMMARY

V_{RWM} (TYP)	I_{PPM} (TYP)	C_{IN} (TYP)
5V	4A	2.7pF

PIN CONFIGURATIONS

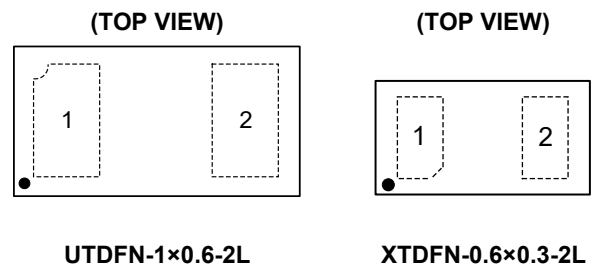

EQUIVALENT CIRCUIT



PACKAGE/ORDERING INFORMATION

MODEL	PACKAGE DESCRIPTION	SPECIFIED TEMPERATURE RANGE	ORDERING NUMBER	PACKAGE MARKING	PACKING OPTION
SGM05CB1A4	UTDFN-1×0.6-2L	-40°C to +125°C	SGM05CB1A4XUEG2G/TR	02X	Tape and Reel, 10000
	XTDFN-0.6×0.3-2L	-40°C to +125°C	SGM05CB1A4XXEI2G/TR	55	Tape and Reel, 10000

MARKING INFORMATION

NOTE: X = Date Code.

UTDFN-1×0.6-2L

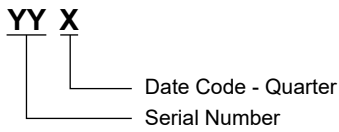

NOTE: Fixed character for 55.

XTDFN-0.6×0.3-2L

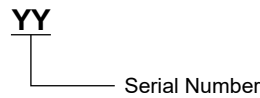

Green (RoHS & HSF): SG Micro Corp defines "Green" to mean Pb-Free (RoHS compatible) and free of halogen substances. If you have additional comments or questions, please contact your SGMICRO representative directly.

DISCLAIMER

SG Micro Corp reserves the right to make any change in circuit design, or specifications without prior notice.

ELECTRICAL PARAMETERS

SYMBOL	PARAMETER
V_{RWM}	Reverse Stand-Off Voltage
V_{BR}	Reverse Breakdown Voltage
I_R	Reverse Leakage Current
$I_R @ BR$	Reverse Leakage Current @ Breakdown
V_C	Clamping Voltage @ I_{PP}
I_{PP}	Peak Pulse Current
R_{DYN}	Dynamic Resistance

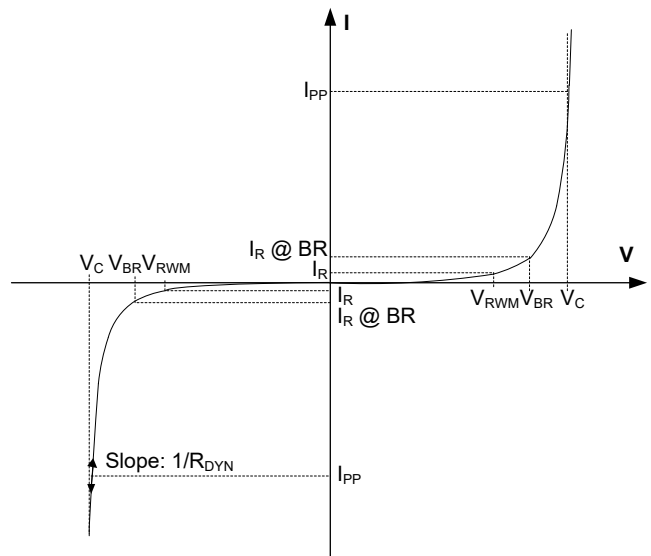

ELECTRICAL CHARACTERISTICS

(T_A = +25°C, unless otherwise noted.)

PARAMETER	SYMBOL	CONDITIONS	MIN	TYP	MAX	UNITS
Reverse Stand-Off Voltage	V _{RWM}				5	V
Reverse Breakdown Voltage	V _{BR}	I _R = 1mA	6.5	7.5	9.5	V
Reverse Leakage Current	I _R	V _R = 5V			500	nA
Channel Input Capacitance	C _{IN}	V _R = 0V, f = 1MHz, I/O to GND		2.7	3.3	pF
Surge Clamping Voltage ⁽¹⁾	V _{C-Surge}	I _{PPM} = 4A		11	13	V
ESD Clamping Voltage ⁽²⁾	V _C	I _{TLP} = 8A (Equivalent IEC61000-4-2 Contact + 4kV)		12		V
		I _{TLP} = 16A (Equivalent IEC61000-4-2 Contact + 8kV)		15		
Dynamic Resistance ⁽²⁾	R _{DYN}	t _p = 100ns		0.35		Ω

NOTES:

1. Non-repetitive current pulse 8/20μs exponential decay waveform according to IEC 61000-4-5, 2Ω source impedance.
2. Non-repetitive current pulse, Transmission Line Pulse (TLP) t_p = 100ns, square pulse.

Positive 8kV:

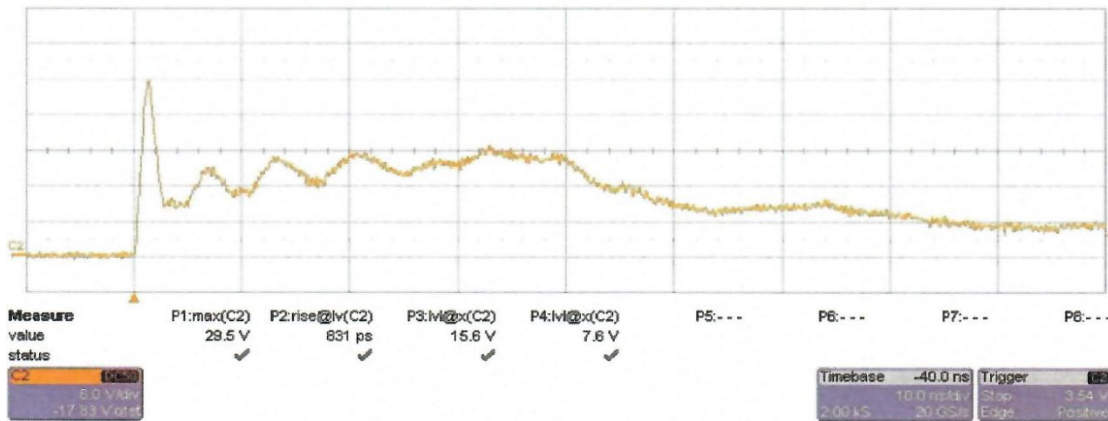

Figure 1. Typical Pulses ESD 8kV Contact per IEC 61000-4-2

Negative 8kV:

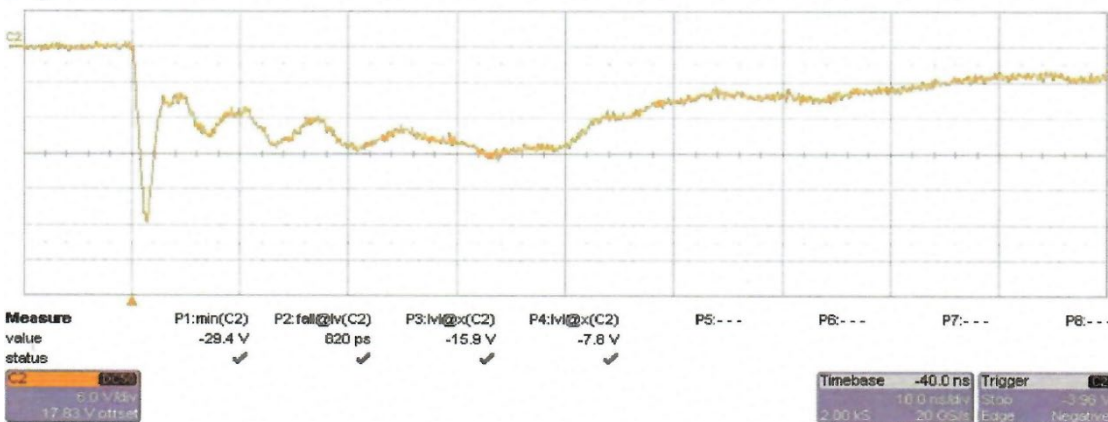
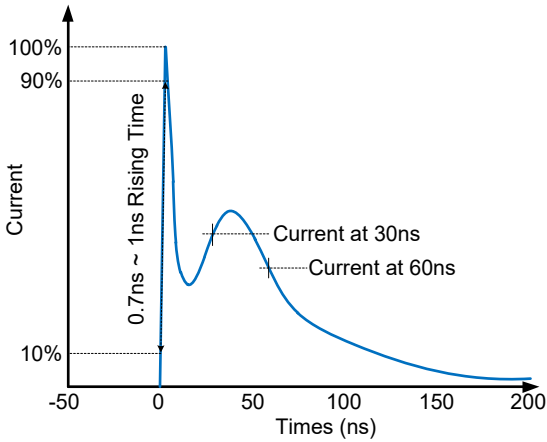

Figure 2. Typical Pulses ESD -8kV Contact per IEC 61000-4-2

TYPICAL PERFORMANCE CHARACTERISTICS

ESD Pulse Waveform per IEC 61000-4-2



8/20µs Waveform per IEC 61000-4-5

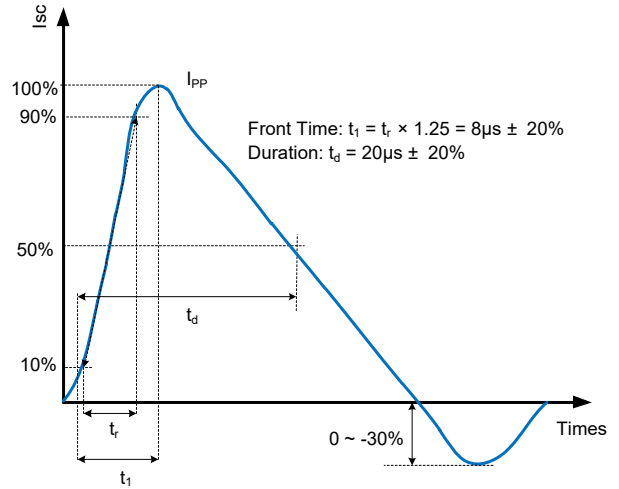

TLP_Pin1(-) to Pin2(+)

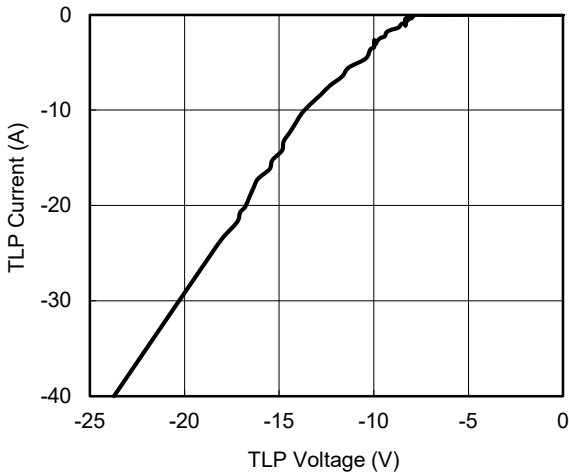

TLP_Pin1(+) to Pin2(-)

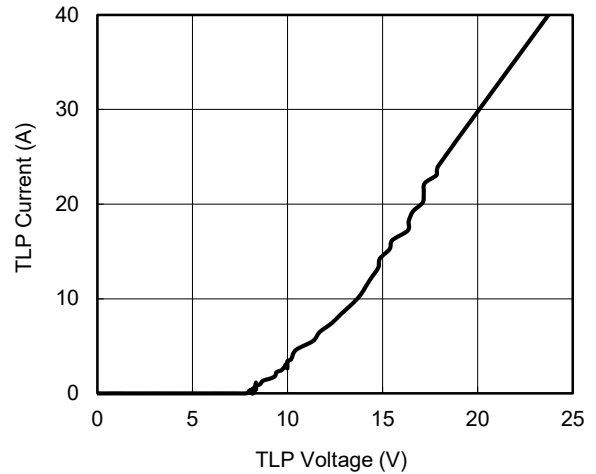

IV Curve

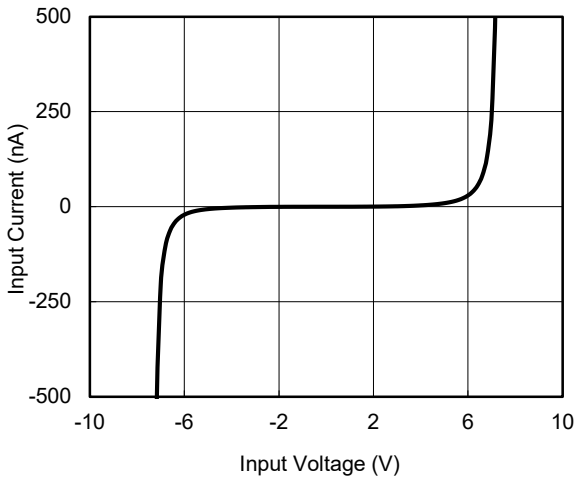

Capacitance vs. Reverse Voltage

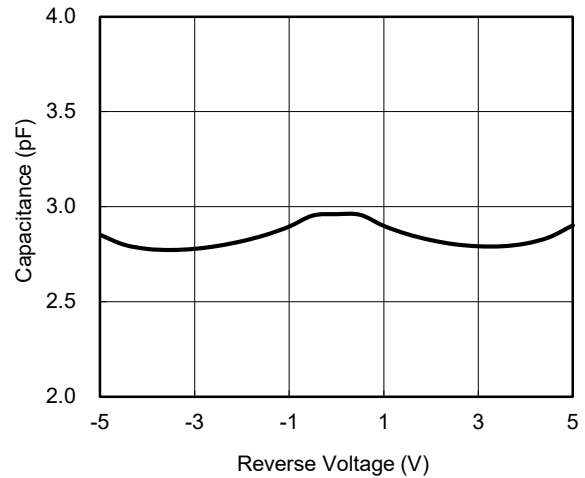

APPLICATION INFORMATION

The TVS is designed to provide a bidirectional line for dissipating ESD events on high-speed signal. The TVS is suitable for lines with positive and negative signal polarity relative to the ground.

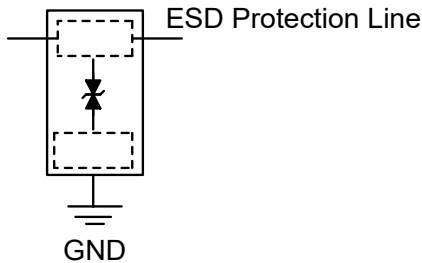

The following guidelines are recommended:

1. TVS Placement

Place the TVS as close to the input connector as possible.

2. TVS's Trace Layout

Avoid running protected traces in parallel with unprotected traces.

Minimize the path length between the TVS and the protected line.

Minimize parallel signal path length.

Route the protected traces as straight as possible.

3. GND Layout

Avoid using a common ground point shared with the TVS transient return path.

Minimize the length of the TVS transient return path to ground.

Use ground vias as close as possible to the TVS transient return to ground.

REVISION HISTORY

NOTE: Page numbers for previous revisions may differ from page numbers in the current version.

Changes from REV.A (APRIL 2023) to REV.A.1	Page
Updated typical performance characteristics section	4
Changes from Original (APRIL 2023) to REV.A	Page
Changed from product preview to production data	All

PACKAGE INFORMATION

PACKAGE OUTLINE DIMENSIONS

UTDFN-1x0.6-2L

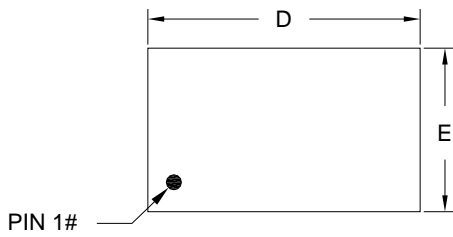

TOP VIEW

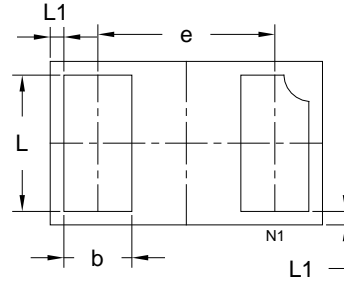

BOTTOM VIEW

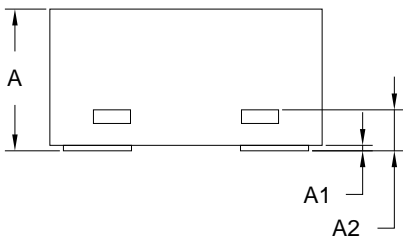

SIDE VIEW

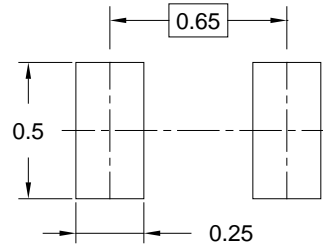

RECOMMENDED LAND PATTERN (Unit: mm)

Symbol	Dimensions In Millimeters		
	MIN	MOD	MAX
A	0.450	0.500	0.550
A1	0.000	-	0.050
A2	0.120	0.150	0.180
b	0.200	0.250	0.300
D	0.950	1.000	1.050
E	0.550	0.600	0.650
e	0.650 BSC		
L	0.450	0.500	0.550
L1	0.050 REF		

NOTE: This drawing is subject to change without notice.

PACKAGE OUTLINE DIMENSIONS

XTDFN-0.6x0.3-2L

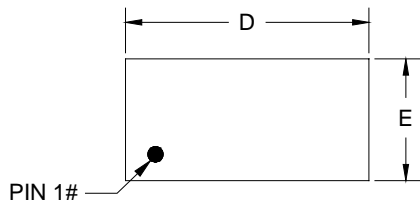

TOP VIEW

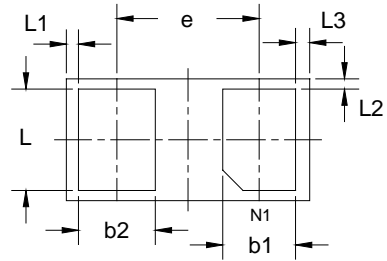

BOTTOM VIEW

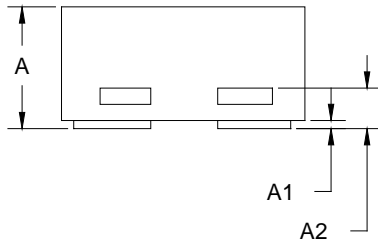

SIDE VIEW

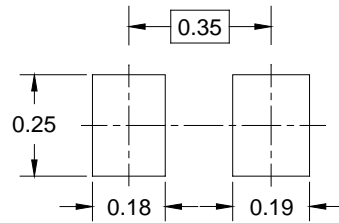

RECOMMENDED LAND PATTERN (Unit: mm)

Symbol	Dimensions In Millimeters		
	MIN	MOD	MAX
A	0.280	0.300	0.320
A1	0.000	0.020	0.050
A2	0.050	0.100	0.150
b1	0.130	0.180	0.230
b2	0.140	0.190	0.240
D	0.550	0.600	0.650
E	0.250	0.300	0.350
e	0.350 BSC		
L	0.200	0.250	0.300
L1	0.030 BSC		
L2	0.025 BSC		
L3	0.035 BSC		

NOTE: This drawing is subject to change without notice.

TAPE AND REEL INFORMATION

REEL DIMENSIONS

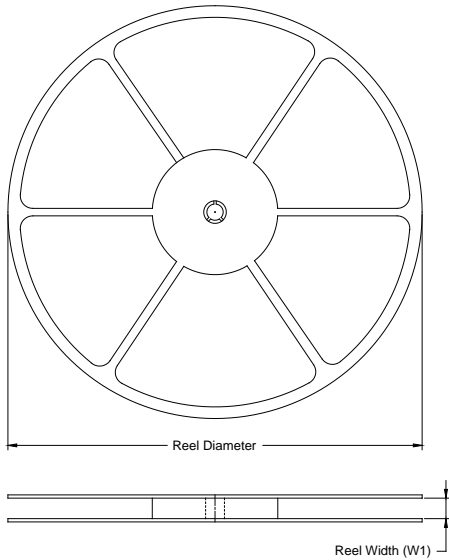

TAPE DIMENSIONS

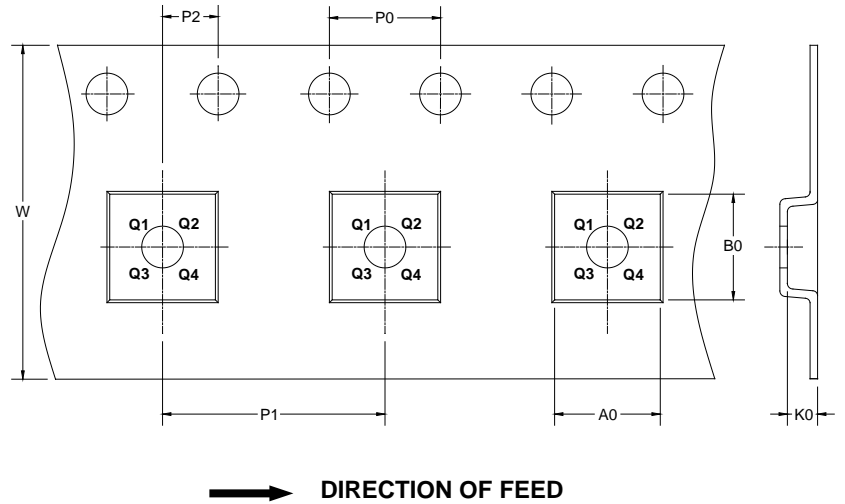

NOTE: The picture is only for reference. Please make the object as the standard.

KEY PARAMETER LIST OF TAPE AND REEL

Package Type	Reel Diameter	Reel Width W1 (mm)	A0 (mm)	B0 (mm)	K0 (mm)	P0 (mm)	P1 (mm)	P2 (mm)	W (mm)	Pin1 Quadrant
UTDFN-1x0.6-2L	7"	8.6	0.70	1.15	0.57	4.0	2.0	2.0	8.0	Q1
XTDFN-0.6x0.3-2L	7"	8.6	0.37	0.67	0.34	4.0	2.0	2.0	8.0	Q1

D20001

PACKAGE INFORMATION

CARTON BOX DIMENSIONS



NOTE: The picture is only for reference. Please make the object as the standard.

KEY PARAMETER LIST OF CARTON BOX

Reel Type	Length (mm)	Width (mm)	Height (mm)	Pizza/Carton
7" (Option)	368	227	224	8
7"	442	410	224	18

DD0002