



SGM8270-2

Low Noise, Precision, High Voltage, Rail-to-Rail I/O Operational Amplifier

GENERAL DESCRIPTION

The SGM8270-2 is a dual, low noise, precision operational amplifier, optimized for high voltage operation from 3.3V to 36V single supply or $\pm 1.65\text{V}$ to $\pm 18\text{V}$ dual power supplies. It provides rail-to-rail input with a wide input common mode voltage range and rail-to-rail output voltage swing.

Furthermore, the SGM8270-2 provides high slew rate, low noise, low offset current and voltage, and low bias current.

The SGM8270-2 is available in Green SOIC-8 and MSOP-8 packages. It is specified over the extended -40°C to $+125^{\circ}\text{C}$ temperature range.

FEATURES

- Rail-to-Rail Input and Output
- Wide Input Common Mode and Differential Voltage Ranges
- Low Input Offset Voltage: $\pm 2.8\text{mV}$ (MAX)
- Low Input Bias Current
- Low Input Offset Current
- Output Short-Circuit Protection
- High Input Impedance
- Low Noise: $15\text{nV}/\sqrt{\text{Hz}}$ at 1kHz
- Gain-Bandwidth Product: 2.5MHz
- High Slew Rate: $8\text{V}/\mu\text{s}$
- -40°C to $+125^{\circ}\text{C}$ Operating Temperature Range
- Available in Green SOIC-8 and MSOP-8 Packages

APPLICATIONS

High Impedance Sensor
Photodiode Amplifier
High End, Professional Audio
DAC Output Amplifier
Medical Equipment

PACKAGE/ORDERING INFORMATION

MODEL	PACKAGE DESCRIPTION	SPECIFIED TEMPERATURE RANGE	ORDERING NUMBER	PACKAGE MARKING	PACKING OPTION
SGM8270-2	SOIC-8	-40°C to +125°C	SGM8270-2XS8G/TR	SGM 82702XS8 XXXXX	Tape and Reel, 4000
	MSOP-8	-40°C to +125°C	SGM8270-2XMS8G/TR	SGM82702 XMS8 XXXXX	Tape and Reel, 4000

MARKING INFORMATION

SOIC-8

(1) XXXXX = Date Code, Trace Code and Vendor Code.

XXXXX

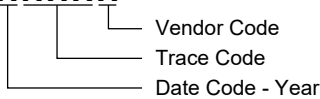

MSOP-8

(2) XXXXX = Date Code and Vendor Code.

XXXXX

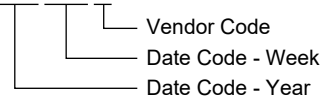

Green (RoHS & HSF): SG Micro Corp defines "Green" to mean Pb-Free (RoHS compatible) and free of halogen substances. If you have additional comments or questions, please contact your SGMICRO representative directly.

ABSOLUTE MAXIMUM RATINGS

- Supply Voltage, +V_S to -V_S.....40V
- Differential Input Voltage, |V_{ID}| (+V_S) - (-V_S)
- Input Common Mode Voltage Range, V_{CM}
.....(-V_S) - 0.1V to (+V_S) + 0.1V
- Input/Output Voltage Range.....(-V_S) - 0.3V to (+V_S) + 0.3V
- Junction Temperature.....+150°C
- Storage Temperature Range.....-65°C to +150°C
- Lead Temperature (Soldering, 10s).....+260°C
- ESD Susceptibility
- HBM.....6000V
- MM.....400V
- CDM2000V

RECOMMENDED OPERATING CONDITIONS

- Operating Temperature Range.....-40°C to +125°C

NOTE: 1. It is recommended that CMOS device adopts the proper power supply sequence. Always sort the V_S first, followed by the inputs and outputs.

OVERSTRESS CAUTION

Stresses beyond those listed in Absolute Maximum Ratings may cause permanent damage to the device. Exposure to absolute maximum rating conditions for extended periods may affect reliability. Functional operation of the device at any conditions beyond those indicated in the Recommended Operating Conditions section is not implied.

ESD SENSITIVITY CAUTION

This integrated circuit can be damaged if ESD protections are not considered carefully. SGMICRO recommends that all integrated circuits be handled with appropriate precautions. Failure to observe proper handling and installation procedures can cause damage. ESD damage can range from subtle performance degradation to complete device failure. Precision integrated circuits may be more susceptible to damage because even small parametric changes could cause the device not to meet the published specifications.

DISCLAIMER

SG Micro Corp reserves the right to make any change in circuit design, or specifications without prior notice.

PIN CONFIGURATIONS

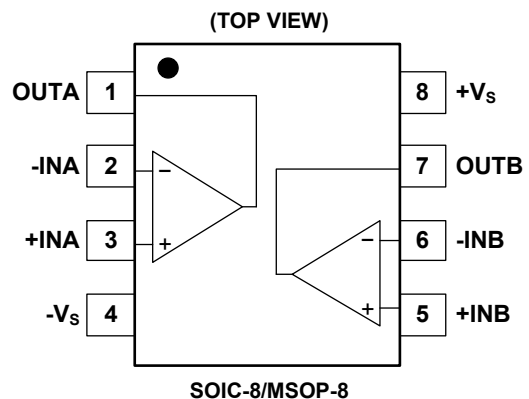

ELECTRICAL CHARACTERISTICS

($V_S = \pm 1.65V$ to $\pm 18V$ and $R_L = 2k\Omega$ connected to $0V$, Full = $-40^\circ C$ to $+125^\circ C$, typical values are at $T_A = +25^\circ C$, unless otherwise noted.)

PARAMETER	SYMBOL	CONDITIONS	TEMP	MIN	TYP	MAX	UNITS
Input Characteristics							
Input Offset Voltage	V_{OS}	$V_{CM} = 0V$	$+25^\circ C$		± 0.5	± 2.8	mV
			Full			± 3	
Input Offset Voltage Drift	$\Delta V_{OS}/\Delta T$		Full		0.8		$\mu V/^\circ C$
Input Bias Current	I_B	$V_{CM} = 0V$	$+25^\circ C$		± 10	± 300	pA
			Full			± 10	nA
Input Offset Current	I_{OS}	$V_{CM} = 0V$	$+25^\circ C$		± 10	± 300	pA
			Full			± 5	nA
Maximum Input Difference Bias Current	$ I_{ID} $	$V_S = \pm 18V, V_{ID} = \pm 18V$	$+25^\circ C$		2	3	μA
			Full			4	
Common Mode Rejection Ratio	CMRR	$V_S = \pm 18V,$ $(-V_S) - 0.1V < V_{CM} < (+V_S) - 1.5V$	$+25^\circ C$	96	105		dB
			Full	93			
		$V_S = \pm 18V,$ $(-V_S) - 0.1V < V_{CM} < (+V_S) + 0.1V$	$+25^\circ C$	76	85		
			Full	73			
Open-Loop Voltage Gain	A_{OL}	$(-V_S) + 0.2V < V_{OUT} < (+V_S) - 0.2V,$ $R_L = 10k\Omega$	$+25^\circ C$	103	120		dB
			Full	100			
		$(-V_S) + 0.5V < V_{OUT} < (+V_S) - 0.5V,$ $R_L = 2k\Omega$	$+25^\circ C$	100	120		
			Full	87			
Output Characteristics							
Output Voltage Swing from Rail	V_{OUT}	$V_S = \pm 18V, R_L = 10k\Omega$	$+25^\circ C$		60	80	mV
			Full			110	
		$V_S = \pm 18V, R_L = 2k\Omega$	$+25^\circ C$		300	400	
			Full			540	
Output Short-Circuit Current	I_{SC}	$V_S = \pm 18V$	$+25^\circ C$	± 28	± 40		mA
Power Supply							
Operating Voltage Range	V_S		Full	3.3		36	V
Quiescent Current	I_Q	$I_{OUT} = 0A$	$+25^\circ C$		1	1.24	mA
			Full			1.5	
Power Supply Rejection Ratio	PSRR	$V_S = 3.3V$ to $36V$	$+25^\circ C$	106	120		dB
			Full	103			
Dynamic Performance							
Gain-Bandwidth Product	GBP	$C_L = 50pF$	$+25^\circ C$		2.5		MHz
Phase Margin	ϕ_o	$C_L = 50pF$	$+25^\circ C$		60		$^\circ$
Slew Rate	SR	$V_S = \pm 2.5V$ to $\pm 18V, G = +1$	$+25^\circ C$		8		V/ μs
Overload Recovery Time	ORT	$V_{IN} \times G > V_S$	$+25^\circ C$		1		μs
Total Harmonic Distortion + Noise	THD+N	$V_S = \pm 2.5V$ to $\pm 18V, V_{OUT} = 2V_{P-P},$ $f = 1kHz, G = +1, R_L = 600\Omega$	$+25^\circ C$		0.005		%
			$+25^\circ C$		0.0005		%
Noise							
Input Voltage Noise		$f = 0.1Hz$ to $10Hz$	$+25^\circ C$		3		μV_{P-P}
Input Voltage Noise Density	e_n	$f = 10Hz$	$+25^\circ C$		100		nV/\sqrt{Hz}
		$f = 1kHz$	$+25^\circ C$		15		
Input Current Noise Density	i_n	$f = 1kHz$	$+25^\circ C$		300		fA/\sqrt{Hz}

TYPICAL PERFORMANCE CHARACTERISTICS

At $T_A = +25^\circ\text{C}$, $V_S = 36\text{V}$ and $R_L = 2\text{k}\Omega$, unless otherwise noted.

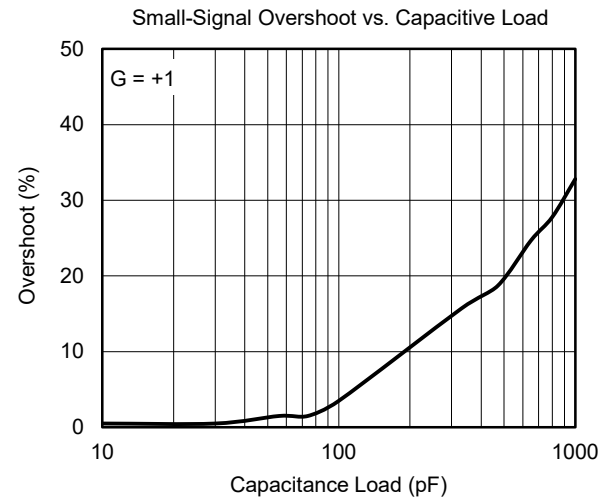
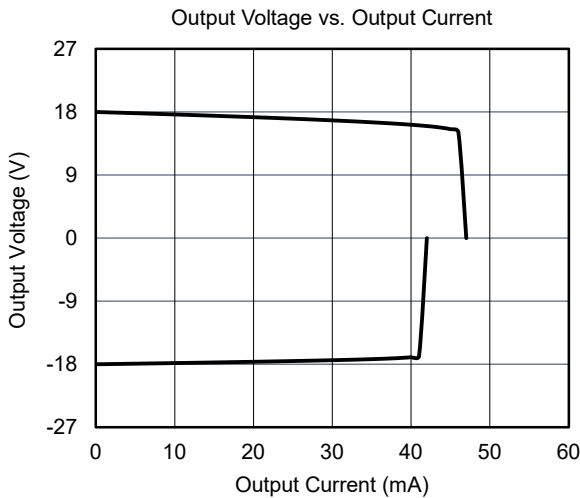
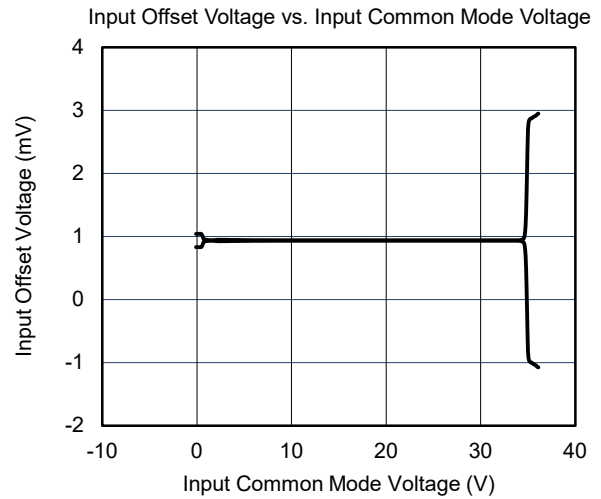
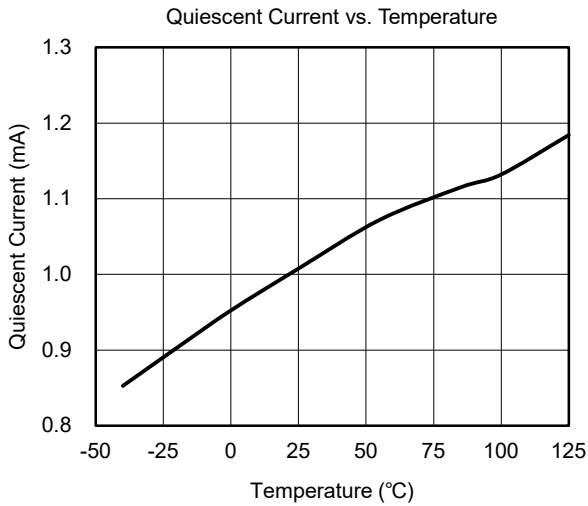
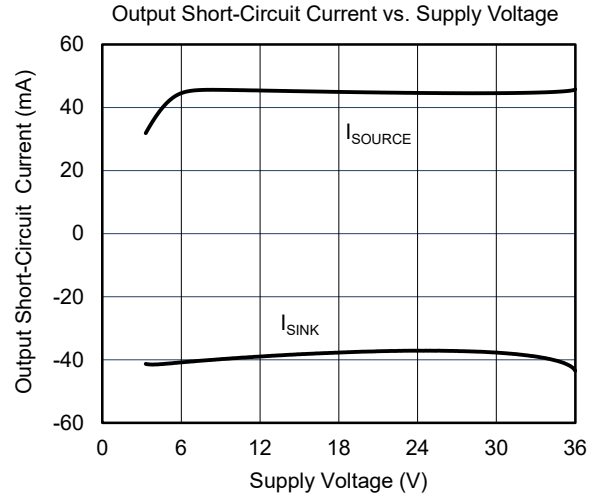
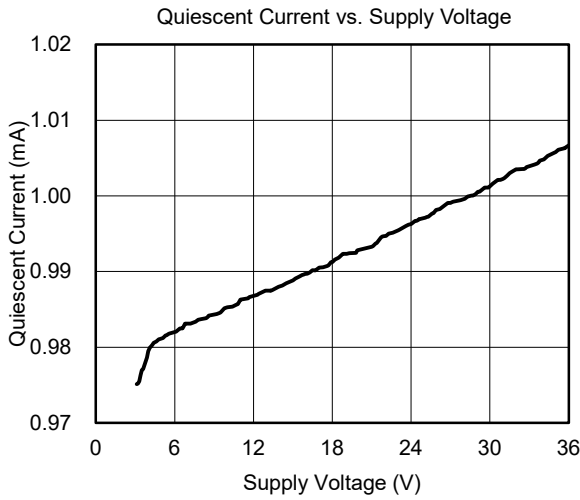

TYPICAL PERFORMANCE CHARACTERISTICS (continued)

At $T_A = +25^\circ\text{C}$, $V_S = 36\text{V}$ and $R_L = 2\text{k}\Omega$, unless otherwise noted.

Large-Signal Step Response

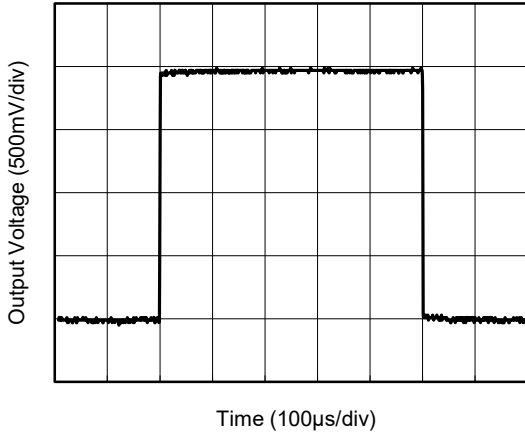

Small-Signal Step Response

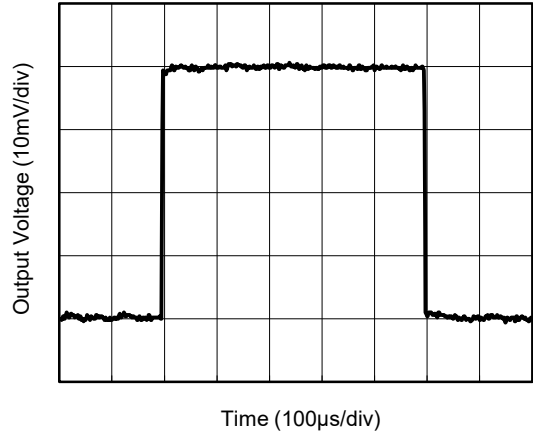

CMRR vs. Frequency

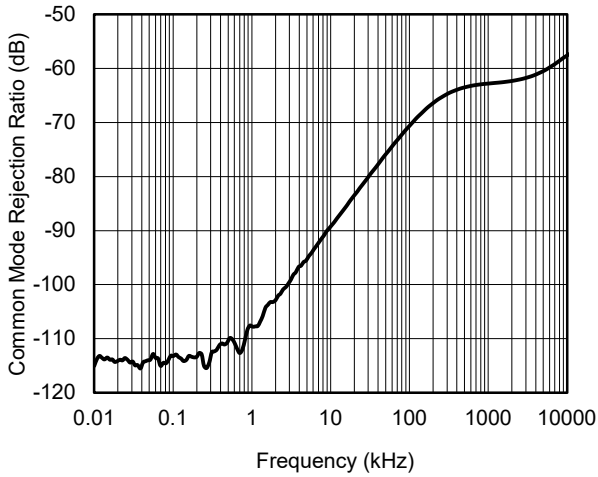

PSRR vs. Frequency

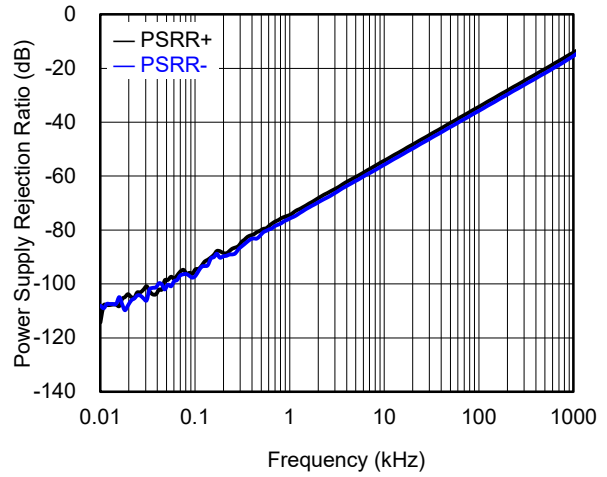

Maximum Output Voltage vs. Frequency

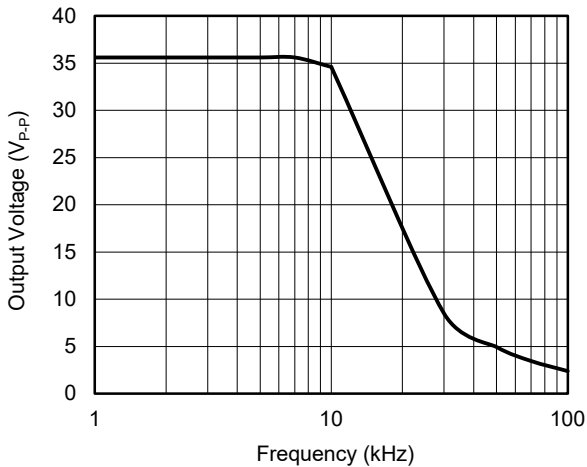

Open-Loop Gain and Phase vs. Frequency

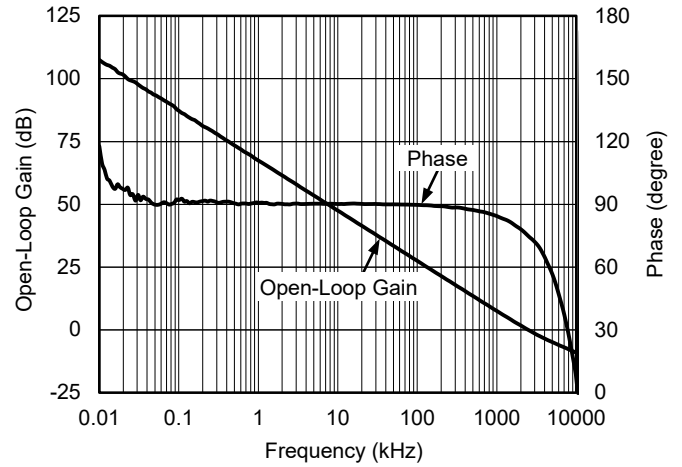

TYPICAL PERFORMANCE CHARACTERISTICS (continued)

At $T_A = +25^\circ\text{C}$, $V_S = 36\text{V}$ and $R_L = 2\text{k}\Omega$, unless otherwise noted.

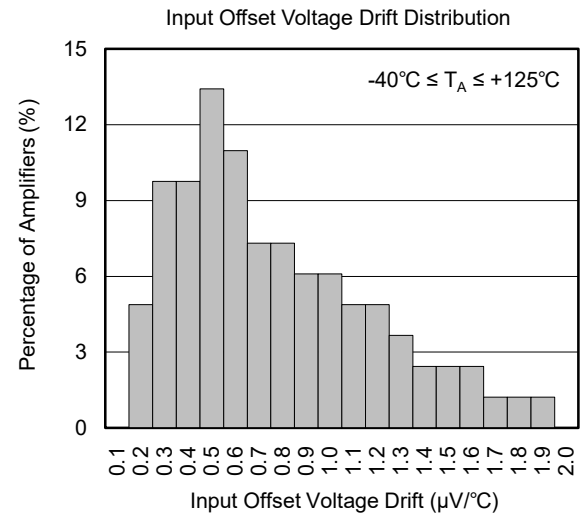
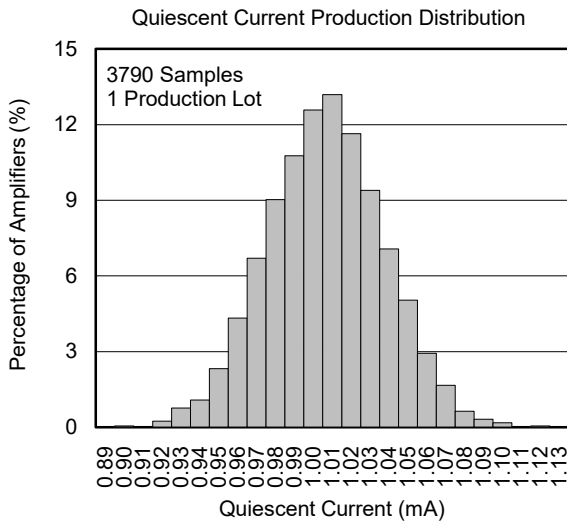
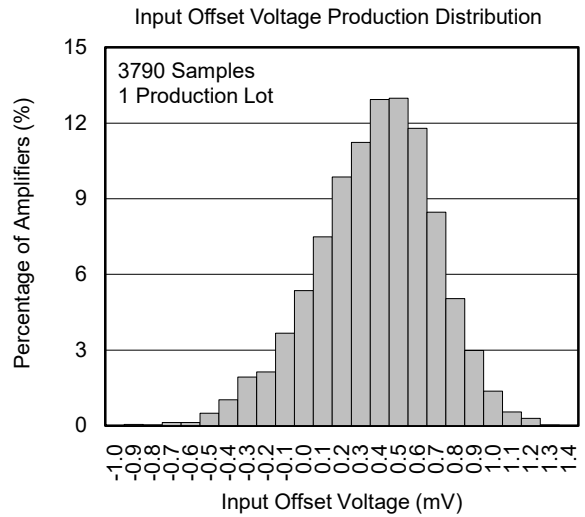
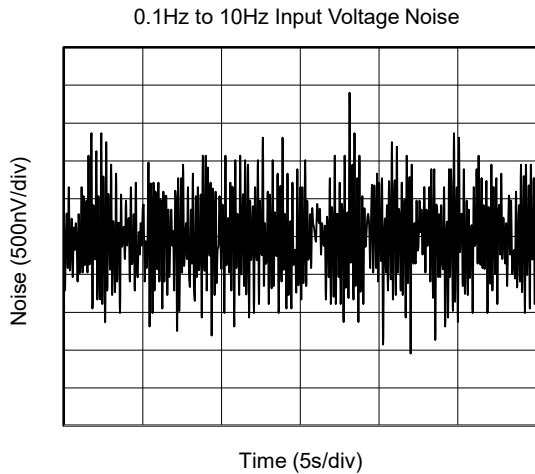
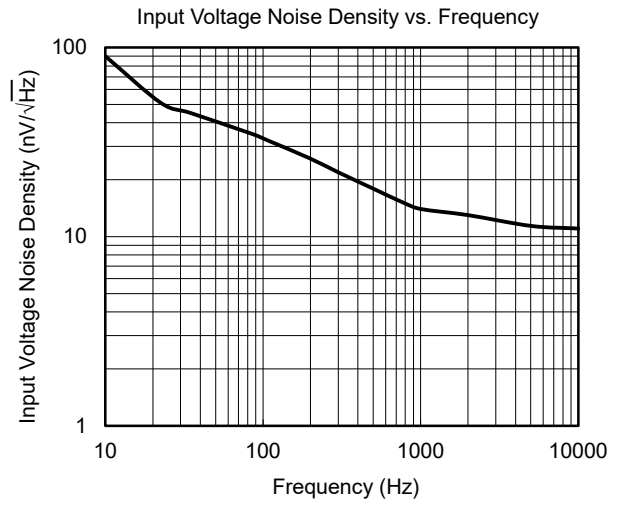
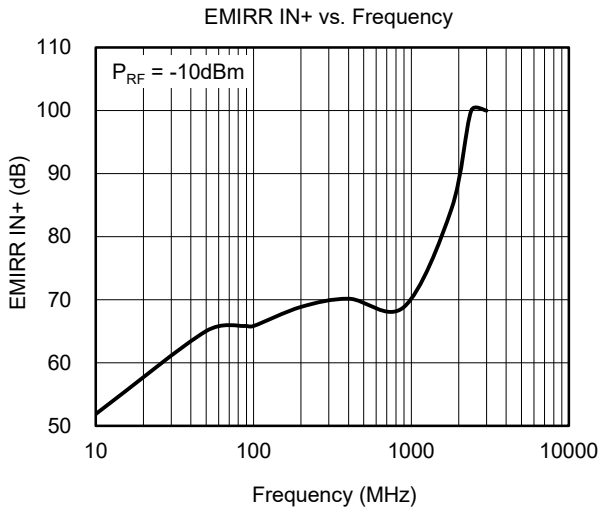

REVISION HISTORY

NOTE: Page numbers for previous revisions may differ from page numbers in the current version.

DECEMBER 2023 – REV.A.2 to REV.A.3	Page
Updated Absolute Maximum Ratings section	2
Updated Electrical Characteristics section	3
Updated Typical Performance Characteristics section	5, 6

NOVEMBER 2020 – REV.A.1 to REV.A.2	Page
Updated Marking Information section.....	2

JUNE 2018 – REV.A to REV.A.1	Page
Added MSOP-8 Package.....	All

Changes from Original (DECEMBER 2017) to REV.A	Page
Changed from product preview to production data.....	All

PACKAGE OUTLINE DIMENSIONS

SOIC-8

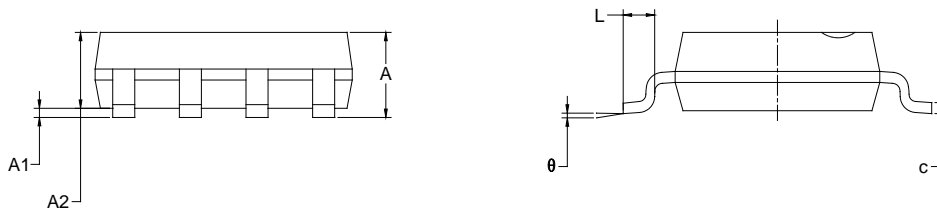
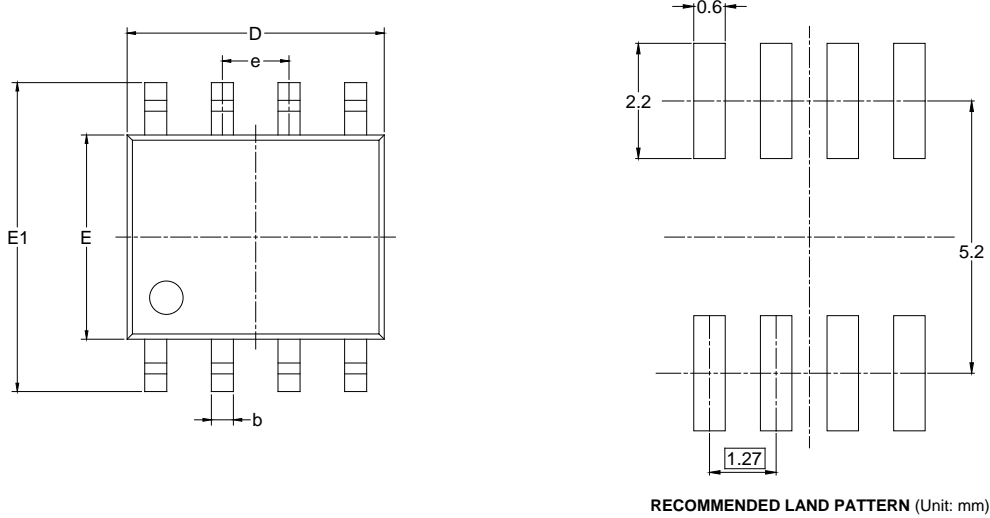

Symbol	Dimensions In Millimeters		Dimensions In Inches	
	MIN	MAX	MIN	MAX
A	1.350	1.750	0.053	0.069
A1	0.100	0.250	0.004	0.010
A2	1.350	1.550	0.053	0.061
b	0.330	0.510	0.013	0.020
c	0.170	0.250	0.006	0.010
D	4.700	5.100	0.185	0.200
E	3.800	4.000	0.150	0.157
E1	5.800	6.200	0.228	0.244
e	1.27 BSC		0.050 BSC	
L	0.400	1.270	0.016	0.050
θ	0°	8°	0°	8°

NOTES:
 1. Body dimensions do not include mode flash or protrusion.
 2. This drawing is subject to change without notice.

PACKAGE OUTLINE DIMENSIONS

MSOP-8

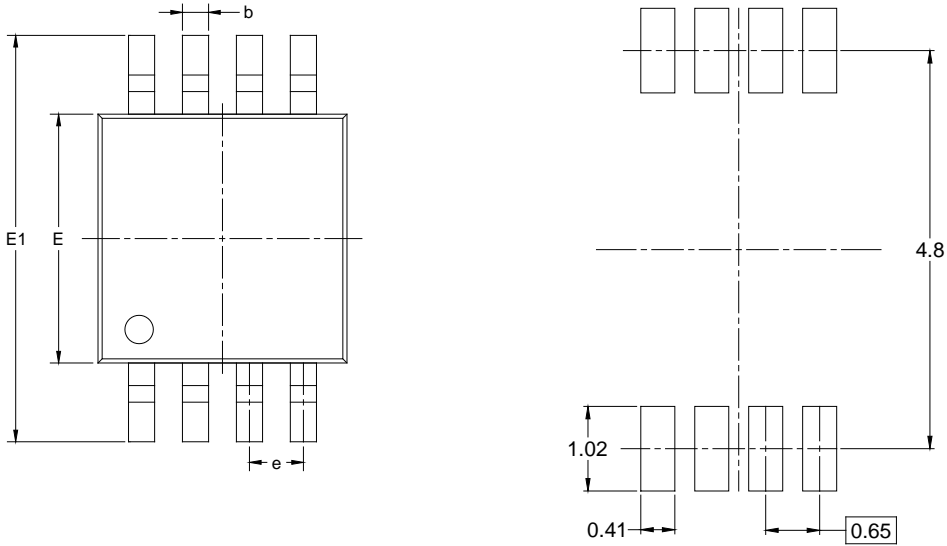

RECOMMENDED LAND PATTERN (Unit: mm)

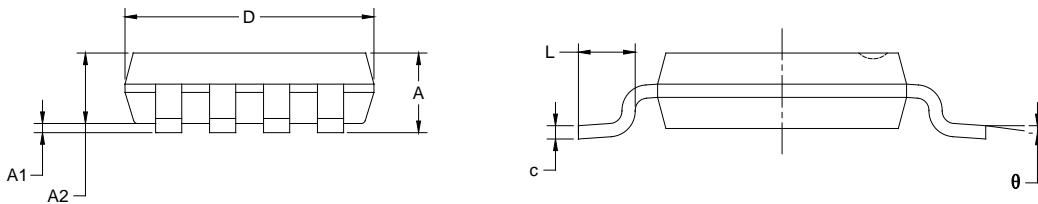

Symbol	Dimensions In Millimeters		Dimensions In Inches	
	MIN	MAX	MIN	MAX
A	0.820	1.100	0.032	0.043
A1	0.020	0.150	0.001	0.006
A2	0.750	0.950	0.030	0.037
b	0.250	0.380	0.010	0.015
c	0.090	0.230	0.004	0.009
D	2.900	3.100	0.114	0.122
E	2.900	3.100	0.114	0.122
E1	4.750	5.050	0.187	0.199
e	0.650 BSC		0.026 BSC	
L	0.400	0.800	0.016	0.031
θ	0°	6°	0°	6°

- NOTES:
 1. Body dimensions do not include mode flash or protrusion.
 2. This drawing is subject to change without notice.

TAPE AND REEL INFORMATION

REEL DIMENSIONS



TAPE DIMENSIONS



NOTE: The picture is only for reference. Please make the object as the standard.

KEY PARAMETER LIST OF TAPE AND REEL

Package Type	Reel Diameter	Reel Width W1 (mm)	A0 (mm)	B0 (mm)	K0 (mm)	P0 (mm)	P1 (mm)	P2 (mm)	W (mm)	Pin1 Quadrant
SOIC-8	13"	12.4	6.40	5.40	2.10	4.0	8.0	2.0	12.0	Q1
MSOP-8	13"	12.4	5.20	3.30	1.50	4.0	8.0	2.0	12.0	Q1

DD0001

PACKAGE INFORMATION

CARTON BOX DIMENSIONS



NOTE: The picture is only for reference. Please make the object as the standard.

KEY PARAMETER LIST OF CARTON BOX

Reel Type	Length (mm)	Width (mm)	Height (mm)	Pizza/Carton
13"	386	280	370	5

DD0002