



SGM8591

Single-Supply, Single Rail-to-Rail I/O Precision Operational Amplifier

GENERAL DESCRIPTION

The SGM8591 is a single, precision operational amplifier which can operate from 2.5V to 5.5V single supply. The device provides rail-to-rail input and output operation.

The SGM8591 offers a low offset voltage less than 500 μ V and an ultra-low bias current of 15pA. The combination of characteristics makes the SGM8591 a good choice for temperature measurements, pressure and position sensors, strain gauge amplifiers and medical instrumentation, or any other 2.5V to 5.5V applications requiring precision and long-term stability.

The SGM8591 is available in Green SOIC-8 and SOT-23-5 packages. It is specified over the extended industrial temperature range (-40°C to +85°C).

FEATURES

- **Low Offset Voltage: 500 μ V (MAX)**
- **Ultra-Low Input Bias Current: 15pA**
- **Large-Signal Voltage Gain: 145dB (TYP) at 5V**
- **PSRR: 120dB (TYP)**
- **CMRR: 90dB (TYP)**
- **Overload Recovery Time: 70 μ s (at $V_S = 5V$)**
- **Rail-to-Rail Input and Output**
- **Supply Voltage Range: 2.5V to 5.5V**
- **Low Supply Current: 445 μ A at 5V**
- **No External Capacitors Required**
- **-40°C to +85°C Operating Temperature Range**
- **Available in Green SOT-23-5 and SOIC-8 Packages**

APPLICATIONS

Pressure Sensors
Temperature Measurements
Precision Current Sensing
Electronic Scales
Strain Gauge Amplifiers
Handheld Test Equipment
Thermocouple Amplifiers
Medical Instrumentation

PACKAGE/ORDERING INFORMATION

MODEL	PACKAGE DESCRIPTION	SPECIFIED TEMPERATURE RANGE	ORDERING NUMBER	PACKAGE MARKING	PACKING OPTION
SGM8591	SOT-23-5	-40°C to +85°C	SGM8591YN5G/TR	S26XX	Tape and Reel, 3000
	SOIC-8	-40°C to +85°C	SGM8591YS8G/TR	SGM8591YS8 XXXXX	Tape and Reel, 2500

MARKING INFORMATION

NOTE: XX = Date Code. XXXXX = Date Code and Vendor Code.

SOT-23-5

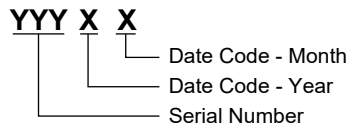

SOIC-8

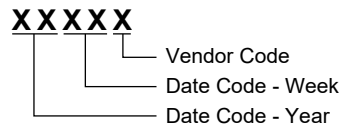

Green (RoHS & HSF): SG Micro Corp defines "Green" to mean Pb-Free (RoHS compatible) and free of halogen substances. If you have additional comments or questions, please contact your SGMICRO representative directly.

ABSOLUTE MAXIMUM RATINGS

- Supply Voltage.....6V
- Input Voltage Range-V_S to (+V_S) + 0.1V
- Differential Input Voltage Range -5V to 5V
- Junction Temperature.....+150°C
- Storage Temperature Range -65°C to +150°C
- Lead Temperature (Soldering, 10s).....+260°C
- ESD Susceptibility
- HBM.....4000V
- MM.....400V

RECOMMENDED OPERATING CONDITIONS

- Operating Temperature Range-40°C to +85°C

OVERSTRESS CAUTION

Stresses beyond those listed in Absolute Maximum Ratings may cause permanent damage to the device. Exposure to absolute maximum rating conditions for extended periods may affect reliability. Functional operation of the device at any conditions beyond those indicated in the Recommended Operating Conditions section is not implied.

ESD SENSITIVITY CAUTION

This integrated circuit can be damaged if ESD protections are not considered carefully. SGMICRO recommends that all integrated circuits be handled with appropriate precautions. Failure to observe proper handling and installation procedures can cause damage. ESD damage can range from subtle performance degradation to complete device failure. Precision integrated circuits may be more susceptible to damage because even small parametric changes could cause the device not to meet the published specifications.

DISCLAIMER

SG Micro Corp reserves the right to make any change in circuit design, or specifications without prior notice.

PIN CONFIGURATIONS

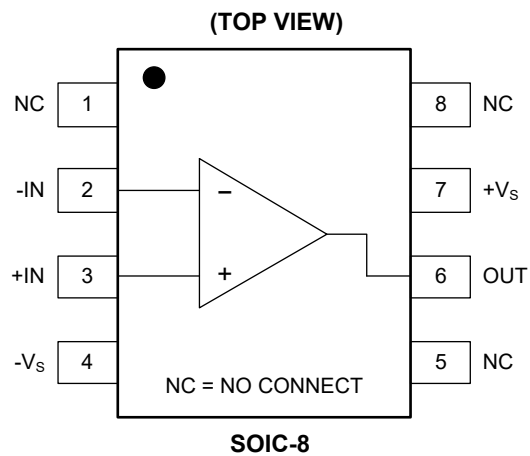
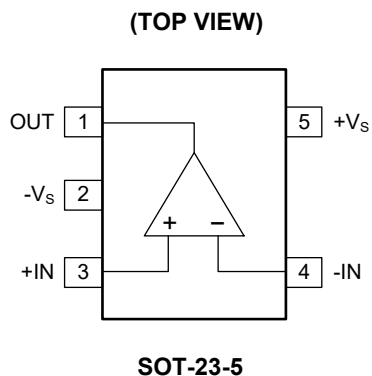

ELECTRICAL CHARACTERISTICS(V_S = 5V, V_{CM} = 2.5V, V_{OUT} = 2.5V, Full = -40°C to +85°C, typical values are at T_A = +25°C, unless otherwise noted.)

PARAMETER	CONDITIONS	TEMP	MIN	TYP	MAX	UNITS
Input Characteristics						
Input Offset Voltage (V _{OS})		+25°C		150	500	μV
		Full			550	
Input Bias Current (I _b)		+25°C		15		pA
Input Offset Current (I _{OS})		+25°C		10		pA
Input Voltage Range		+25°C	0		5	V
Common Mode Rejection Ratio ⁽¹⁾ (CMRR)	V _{CM} = 0V to 5V	+25°C	80	90		dB
		Full	62			
Large-Signal Voltage Gain (A _{VO})	R _L = 10kΩ, V _{OUT} = 0.3V to 4.7V	+25°C	95	145		dB
		Full	91			
Input Offset Voltage Drift (ΔV _{OS} /ΔT)		Full		200		nV/°C
Output Characteristics						
Output Voltage High (V _{OH})	R _L = 100kΩ to -V _S	+25°C	4.99	4.998		V
		Full	4.979			
	R _L = 10kΩ to -V _S	+25°C	4.98	4.994		V
		Full	4.96			
Output Voltage Low (V _{OL})	R _L = 100kΩ to +V _S	+25°C		2	10	mV
		Full			11	
	R _L = 10kΩ to +V _S	+25°C		6	15	mV
		Full			18	
Output Short-Circuit Limit (I _{SC})	V _{OUT} = 2.5V, R _L = 10Ω to GND	+25°C	40	45		mA
		Full	26			
Power Supply						
Power Supply Rejection Ratio ⁽¹⁾ (PSRR)	V _S = 2.5V to 5.5V	+25°C	90	120		dB
		Full	73			
Quiescent Current (I _Q)	V _{OUT} = V _S /2	+25°C		445	700	μA
		Full			845	
Dynamic Performance						
Gain-Bandwidth Product (GBP)	A _V = +100	+25°C		1.45		MHz
Slew Rate (SR)	A _V = +1, R _L = 10kΩ, 2V output step	+25°C		0.75		V/μs
Overload Recovery Time	A _V = -100, R _L = 10kΩ, V _{IN} = 200mV (RET to GND)	+25°C		0.07		ms
Noise Performance						
Input Voltage Noise	0.1Hz to 10Hz	+25°C		0.85		μV _{P-P}
Input Voltage Noise Density (e _n)	f = 1kHz	+25°C		47.5		nV/√Hz

NOTE: 1. PSRR and CMRR are affected by the matching between external gain-setting resistor ratios.

ELECTRICAL CHARACTERISTICS (continued)(V_S = 2.5V, V_{CM} = 1.25V, V_{OUT} = 1.25V, Full = -40°C to +85°C, typical values are at T_A = +25°C, unless otherwise noted.)

PARAMETER	CONDITIONS	TEMP	MIN	TYP	MAX	UNITS
Input Characteristics						
Input Offset Voltage (V _{OS})		+25°C		150	500	μV
		Full			550	
Input Bias Current (I _b)		+25°C		15		pA
Input Offset Current (I _{OS})		+25°C		10		pA
Input Voltage Range		+25°C	0		2.5	V
Common Mode Rejection Ratio ⁽¹⁾ (CMRR)	V _{CM} = 0V to 2.5V	+25°C	75	90		dB
		Full	61			
Large-Signal Voltage Gain (A _{VO})	R _L = 10kΩ, V _{OUT} = 0.3V to 2.4V	+25°C	95	140		dB
		Full	91			
Input Offset Voltage Drift (ΔV _{OS} /ΔT)		Full		200		nV/°C
Output Characteristics						
Output Voltage High (V _{OH})	R _L = 100kΩ to -V _S	+25°C	2.49	2.498		V
		Full	2.473			
	R _L = 10kΩ to -V _S	+25°C	2.48	2.497		V
		Full	2.46			
Output Voltage Low (V _{OL})	R _L = 100kΩ to +V _S	+25°C		1	10	mV
		Full			11	
	R _L = 10kΩ to +V _S	+25°C		3	15	mV
		Full			16	
Output Short-Circuit Limit (I _{SC})	V _{OUT} = 1.25V, R _L = 10Ω to GND	+25°C	20	27		mA
		Full	14			
Power Supply						
Power Supply Rejection Ratio ⁽¹⁾ (PSRR)	V _S = 2.5V to 5.5V	+25°C	90	120		dB
		Full	73			
Quiescent Current (I _Q)	V _{OUT} = V _S /2	+25°C		440	700	μA
		Full			786	
Dynamic Performance						
Gain-Bandwidth Product (GBP)	A _V = +100	+25°C		1.45		MHz
Slew Rate (SR)	A _V = +1, R _L = 10kΩ, 2V output step	+25°C		0.75		V/μs
Overload Recovery Time	A _V = -100, R _L = 10kΩ, V _{IN} = 200mV (RET to GND)	+25°C		0.04		ms
Noise Performance						
Input Voltage Noise	0.1Hz to 10Hz	+25°C		0.9		μV _{P-P}
Input Voltage Noise Density (e _n)	f = 1kHz	+25°C		77		nV/√Hz

NOTE: 1. PSRR and CMRR are affected by the matching between external gain-setting resistor ratios.

TYPICAL PERFORMANCE CHARACTERISTICS

Large Signal Transient Response at +5V

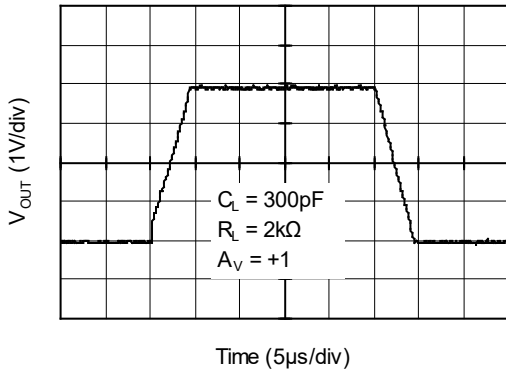

Large Signal Transient Response at +2.5V

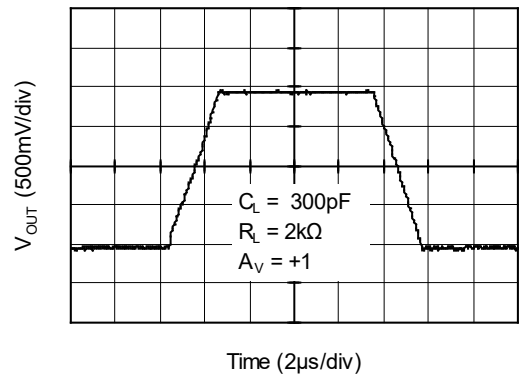

Small Signal Transient Response at +5V

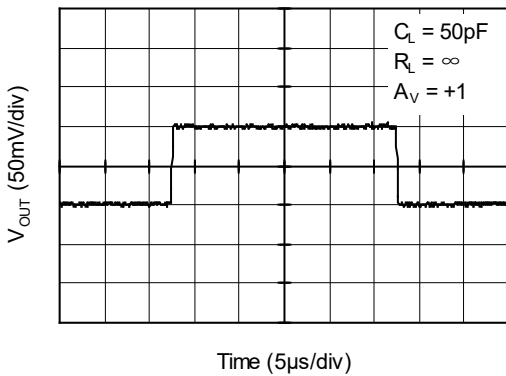

Small Signal Transient Response at +2.5V

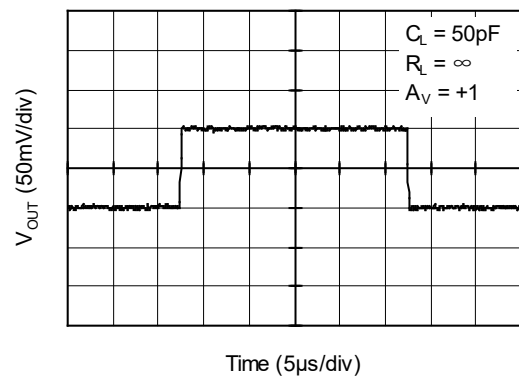

Closed Loop Gain vs. Frequency at +5V

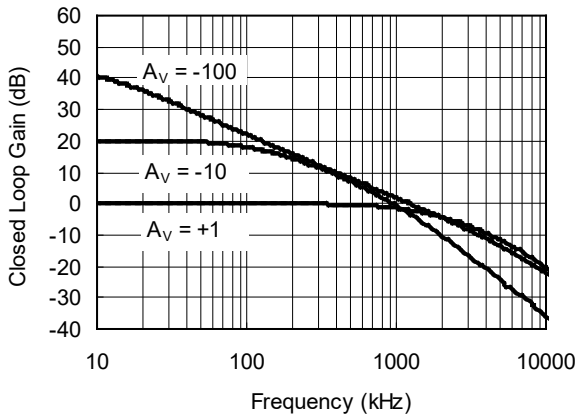

Closed Loop Gain vs. Frequency at +2.5V

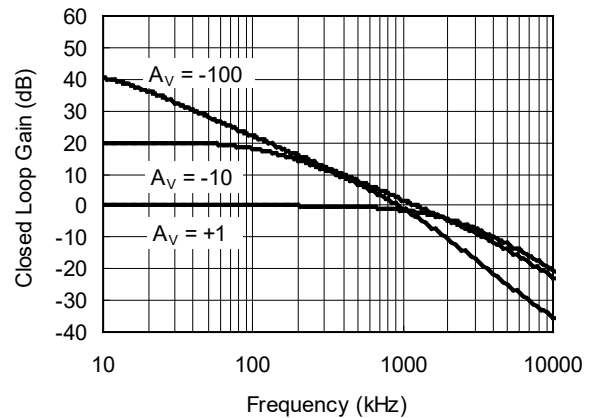

TYPICAL PERFORMANCE CHARACTERISTICS (continued)

0.1Hz to 10Hz Noise at +5V

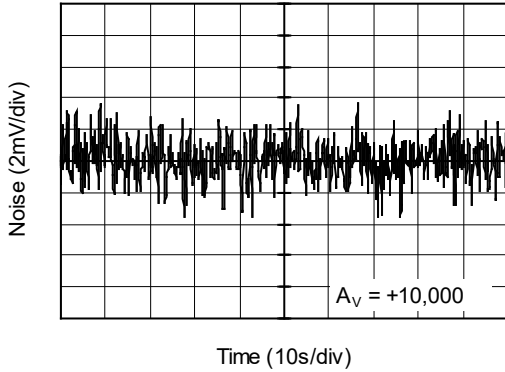

0.1Hz to 10Hz Noise at +2.5V

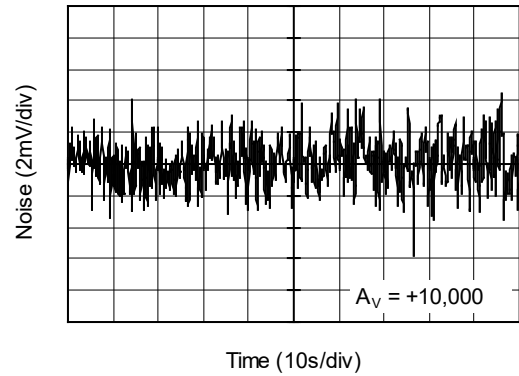

Negative Overvoltage Recovery

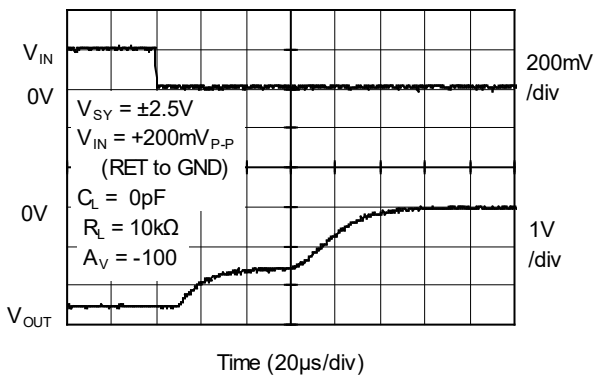

Positive Overvoltage Recovery

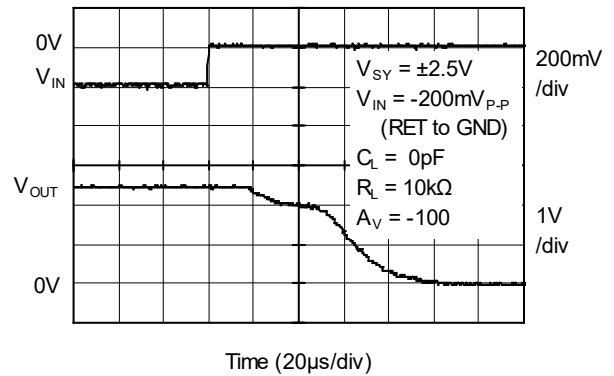

Open Loop Gain, Phase Shift vs. Frequency at +5V

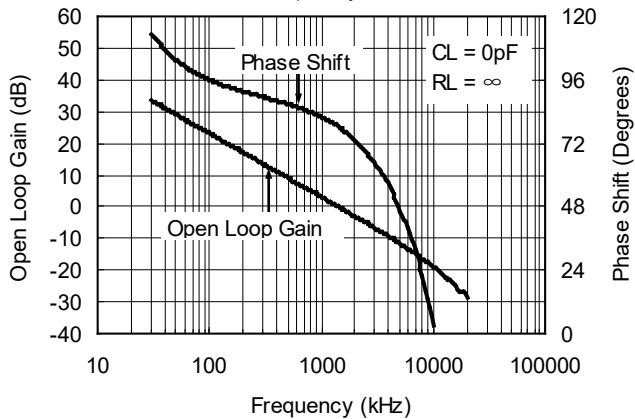

Open Loop Gain, Phase Shift vs. Frequency at +2.5V

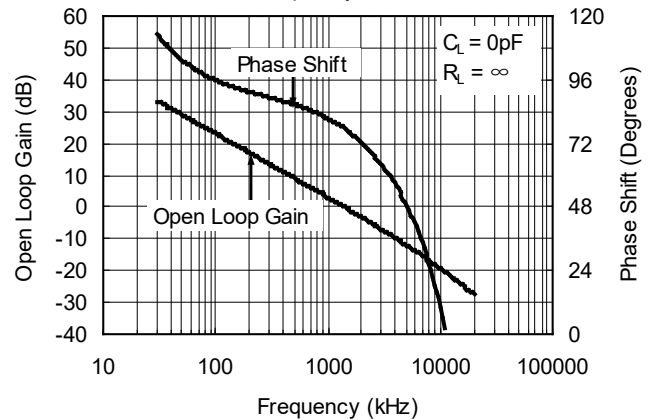

TYPICAL PERFORMANCE CHARACTERISTICS (continued)

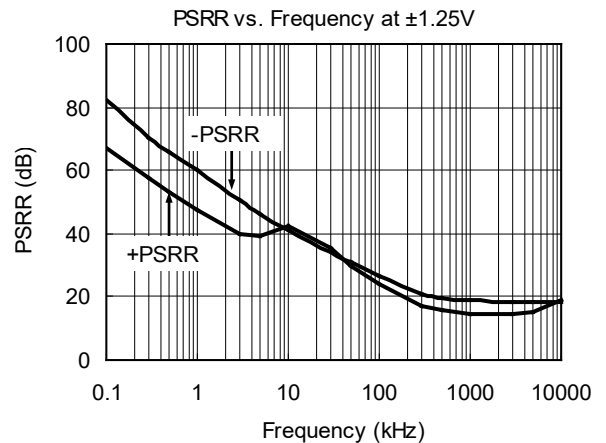
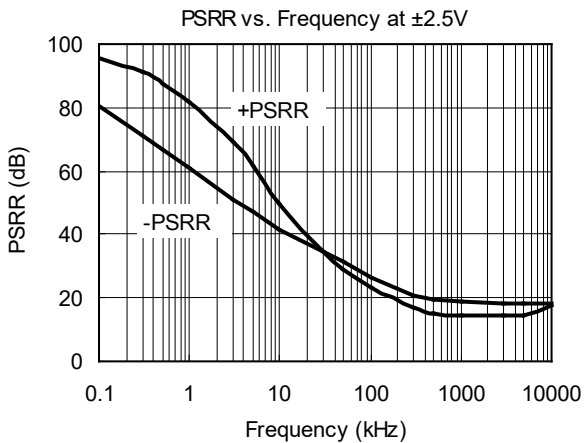
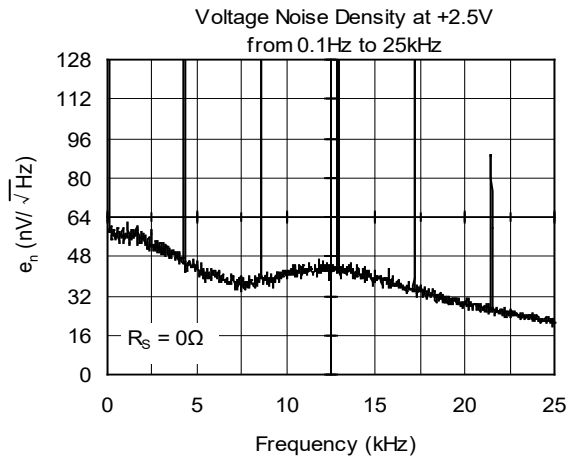
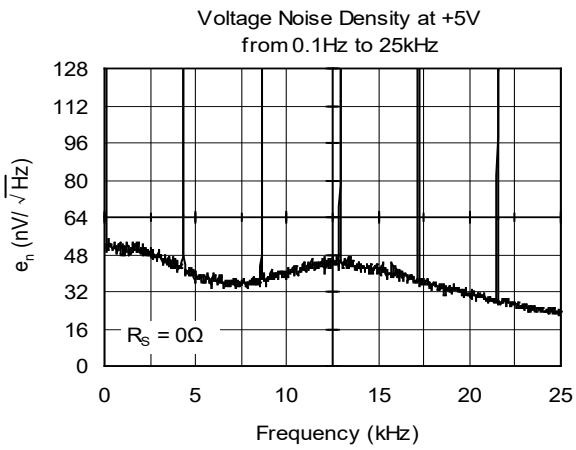
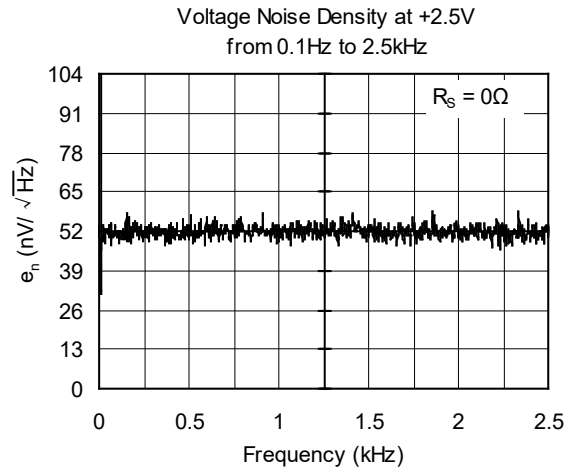
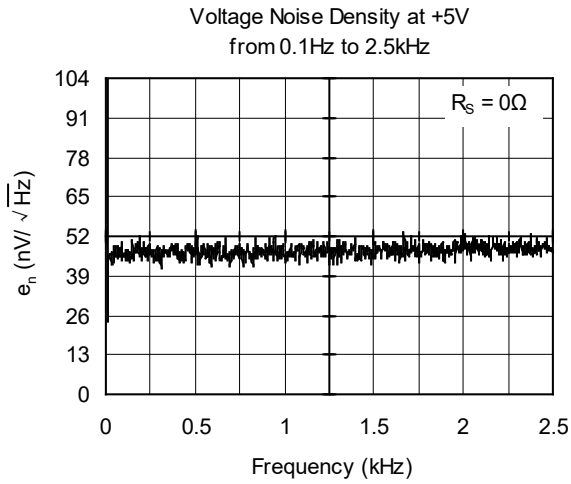

TYPICAL PERFORMANCE CHARACTERISTICS (continued)

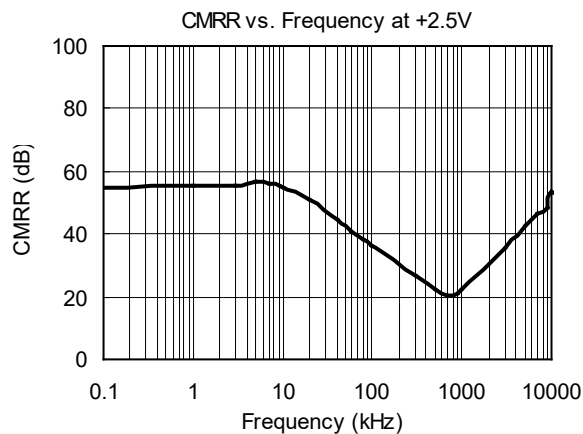
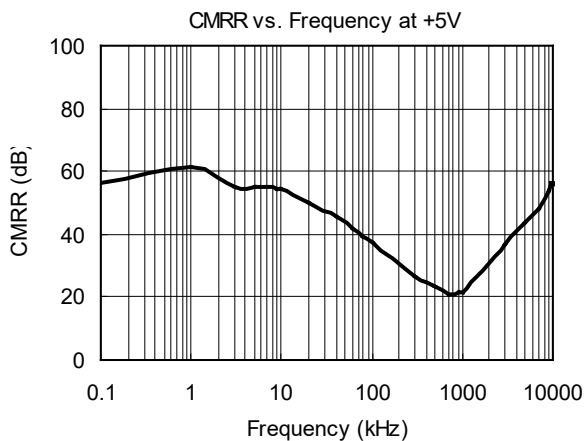

REVISION HISTORY

NOTE: Page numbers for previous revisions may differ from page numbers in the current version.

Changes from Original (JANUARY 2013) to REV.A	Page
Changed from product preview to production data.....	All

PACKAGE OUTLINE DIMENSIONS

SOT-23-5

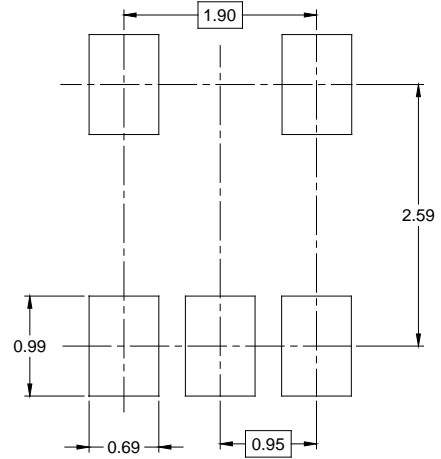
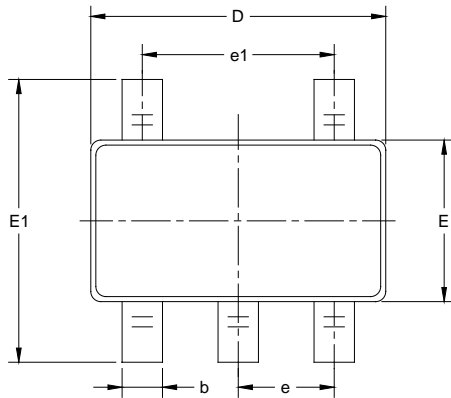

RECOMMENDED LAND PATTERN (Unit: mm)

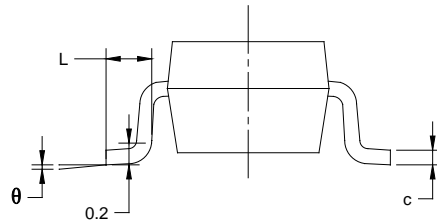
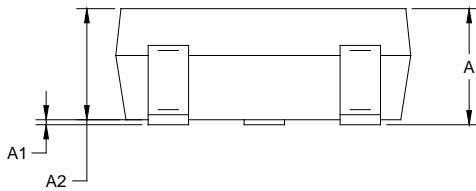

Symbol	Dimensions In Millimeters		Dimensions In Inches	
	MIN	MAX	MIN	MAX
A	1.050	1.250	0.041	0.049
A1	0.000	0.100	0.000	0.004
A2	1.050	1.150	0.041	0.045
b	0.300	0.500	0.012	0.020
c	0.100	0.200	0.004	0.008
D	2.820	3.020	0.111	0.119
E	1.500	1.700	0.059	0.067
E1	2.650	2.950	0.104	0.116
e	0.950 BSC		0.037 BSC	
e1	1.900 BSC		0.075 BSC	
L	0.300	0.600	0.012	0.024
θ	0°	8°	0°	8°

NOTES:

1. Body dimensions do not include mode flash or protrusion.
2. This drawing is subject to change without notice.

PACKAGE OUTLINE DIMENSIONS

SOIC-8

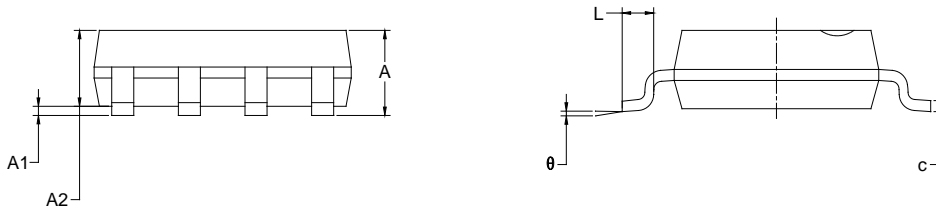
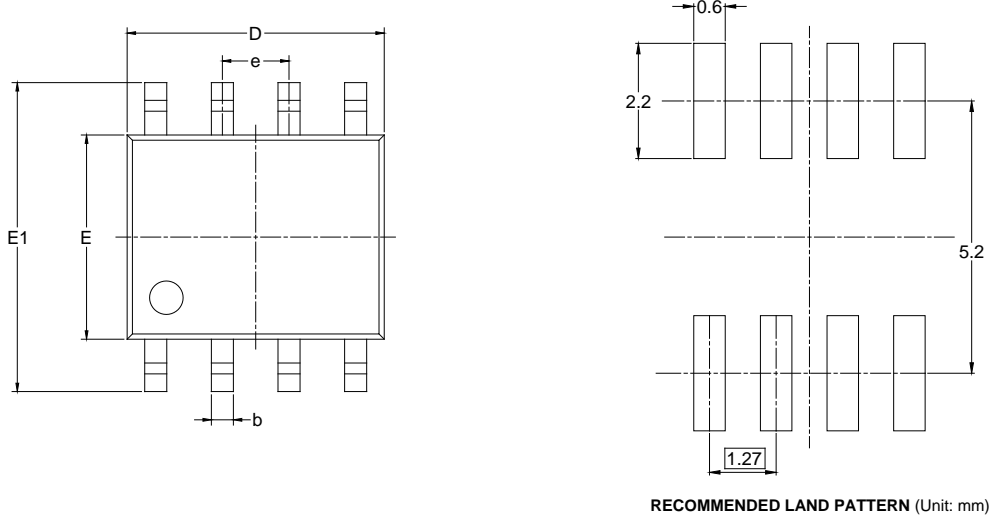

Symbol	Dimensions In Millimeters		Dimensions In Inches	
	MIN	MAX	MIN	MAX
A	1.350	1.750	0.053	0.069
A1	0.100	0.250	0.004	0.010
A2	1.350	1.550	0.053	0.061
b	0.330	0.510	0.013	0.020
c	0.170	0.250	0.006	0.010
D	4.700	5.100	0.185	0.200
E	3.800	4.000	0.150	0.157
E1	5.800	6.200	0.228	0.244
e	1.27 BSC		0.050 BSC	
L	0.400	1.270	0.016	0.050
θ	0°	8°	0°	8°

NOTES:
 1. Body dimensions do not include mode flash or protrusion.
 2. This drawing is subject to change without notice.

TAPE AND REEL INFORMATION

REEL DIMENSIONS



TAPE DIMENSIONS



NOTE: The picture is only for reference. Please make the object as the standard.

KEY PARAMETER LIST OF TAPE AND REEL

Package Type	Reel Diameter	Reel Width W1 (mm)	A0 (mm)	B0 (mm)	K0 (mm)	P0 (mm)	P1 (mm)	P2 (mm)	W (mm)	Pin1 Quadrant
SOT-23-5	7"	9.5	3.20	3.20	1.40	4.0	4.0	2.0	8.0	Q3
SOIC-8	13"	12.4	6.40	5.40	2.10	4.0	8.0	2.0	12.0	Q1

DD0001

PACKAGE INFORMATION

CARTON BOX DIMENSIONS



NOTE: The picture is only for reference. Please make the object as the standard.

KEY PARAMETER LIST OF CARTON BOX

Reel Type	Length (mm)	Width (mm)	Height (mm)	Pizza/Carton
7" (Option)	368	227	224	8
7"	442	410	224	18
13"	386	280	370	5

DD0002