



SGM6613A

28.5V, 7A Fully-Integrated Synchronous Boost Converter

GENERAL DESCRIPTION

The SGM6613A is a high-efficient synchronous Boost converter integrated with a 17mΩ low-side power switch and a 31mΩ high-side power switch. This device is capable to deliver up to 28.5V output and operates at a wide input voltage range of 4.5V to 22V.

The SGM6613A operates the pulse width modulation (PWM) mode at moderate to heavy load conditions. The forced pulse width modulation (PWM) mode is applied at light load condition to prevent operation faults caused by low switching frequency. The SGM6613A also includes the output over-voltage protection, inductor current limit protection and thermal shutdown protection.

The SGM6613A is available in a Green TQFN-3×3.5-13L package.

FEATURES

- **Wide 4.5V to 22V Input Voltage Range**
- **(V_{IN} + 5V) to 28.5V Output Voltage Range**
- **Up to 7A Resistor-Programmable Current Limit**
- **Integrated 17mΩ/31mΩ Power MOSFETs**
- **Up to 90% Efficiency**
(V_{IN} = 5V, V_{OUT} = 28.5V and I_{OUT} = 500mA)
- **Up to 700kHz Resistor-Programmable Switching Frequency**
- **Over-Voltage Protection**
- **Forced PWM Mode at Light Load Condition**
- **Available in a Green TQFN-3×3.5-13L Package**

APPLICATIONS

Portable Loudspeaker Boxes

LCD Display Source Driver

Supply for the Power Amplifier and Motor Driver

Supply for USB Type-C

PACKAGE/ORDERING INFORMATION

MODEL	PACKAGE DESCRIPTION	SPECIFIED TEMPERATURE RANGE	ORDERING NUMBER	PACKAGE MARKING	PACKING OPTION
SGM6613A	TQFN-3x3.5-13L	-40°C to +85°C	SGM6613AYTQX13G/TR	SGM6613A YTQX13 XXXXX	Tape and Reel, 4000

MARKING INFORMATION

NOTE: XXXXX = Date Code, Trace Code and Vendor Code.

XXXXX

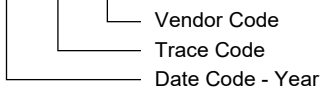

Green (RoHS & HSF): SG Micro Corp defines "Green" to mean Pb-Free (RoHS compatible) and free of halogen substances. If you have additional comments or questions, please contact your SGMICRO representative directly.

ABSOLUTE MAXIMUM RATINGS

- SW and VOUT Voltages -0.3V to 31V
- VIN and EN Voltages -0.3V to 24V
- BOOT Voltage -0.3V to V_{SW} + 5V
- VCC, FB, COMP, FREQ and ILIM Voltages -0.3V to 6V
- Package Thermal Resistance
- TQFN-3x3.5-13L, θ_{JA} 66°C/W
- Junction Temperature +150°C
- Storage Temperature Range -65°C to +150°C
- Lead Temperature (Soldering, 10s) +260°C
- ESD Susceptibility
- HBM 2000V
- CDM 1000V

RECOMMENDED OPERATING CONDITIONS

- Input Voltage Range 4.5V to 22V
- Output Voltage Range (V_{IN} + 5V) to 28.5V
- Operating Junction Temperature Range -40°C to +125°C
- Operating Ambient Temperature Range -40°C to +85°C

OVERSTRESS CAUTION

Stresses beyond those listed in Absolute Maximum Ratings may cause permanent damage to the device. Exposure to absolute maximum rating conditions for extended periods may affect reliability. Functional operation of the device at any conditions beyond those indicated in the Recommended Operating Conditions section is not implied.

ESD SENSITIVITY CAUTION

This integrated circuit can be damaged if ESD protections are not considered carefully. SGMICRO recommends that all integrated circuits be handled with appropriate precautions. Failure to observe proper handling and installation procedures can cause damage. ESD damage can range from subtle performance degradation to complete device failure. Precision integrated circuits may be more susceptible to damage because even small parametric changes could cause the device not to meet the published specifications.

DISCLAIMER

SG Micro Corp reserves the right to make any change in circuit design, or specifications without prior notice.

PIN CONFIGURATION

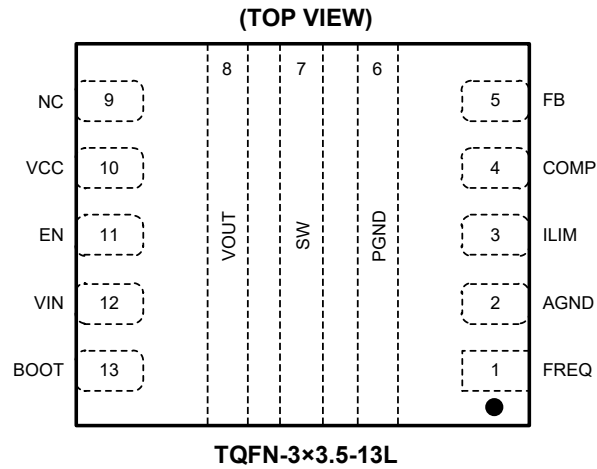

PIN DESCRIPTION

PIN	NAME	I/O	FUNCTION
1	FREQ	I	Adjustable Switching Frequency Pin. Place a resistor between FREQ and the AGND to program the switching frequency.
2	AGND	-	Analog Signal Ground.
3	ILIM	I	Adjustable Peak Current Limit. Place a resistor between this pin and AGND to program the peak current limit.
4	COMP	O	Output of the Internal Error Amplifier. Put the loop compensation network between this pin and the AGND.
5	FB	I	Voltage Feedback. Connect to the resistor divider to program the output voltage.
6	PGND	PWR	Power Ground. Connect to the source of the low-side MOSFET.
7	SW	PWR	Switch Node of the Converter. Connect to the internal power MOSFETs.
8	VOUT	PWR	Boost Converter Output.
9	NC	-	Not Connected.
10	VCC	O	Output of the Internal Regulator. Connect a capacitor ($> 1.0\mu\text{F}$) between this pin and ground.
11	EN	I	Enable Input Pin. Logic high enables the device. Logic low shuts down the device.
12	VIN	I	Power Supply.
13	BOOT	O	Gate Driver Supply of the High-side MOSFET. Connect this pin to SW pin with a ceramic capacitor.

NOTE: I: input, O: output, PWR: power for the circuit.

ELECTRICAL CHARACTERISTICS

(V_{IN} = 4.5V to 22V, V_{OUT} = 28.5V, T_J = -40°C to +85°C, typical values are at T_J = +25°C, unless otherwise noted.)

PARAMETER	SYMBOL	CONDITIONS	MIN	TYP	MAX	UNITS
Power Supply						
Input Voltage Range	V _{IN}		4.5		22	V
Input UVLO Threshold	V _{IN_UVLO}	V _{IN} rising		4.1	4.4	V
Input UVLO Hysteresis	V _{IN_HYS}			160		mV
VCC Regulation Voltage	V _{CC}	I _{CC} = 5mA, V _{IN} = 6V		5		V
Quiescent Current into VIN Pin	I _Q	IC enabled, no load, no switching, V _{IN} = 4.5V, V _{OUT} = 28.5V, V _{FB} = 1.23V		420	510	μA
Quiescent Current into VOUT Pin				150	200	
Shutdown Current into VIN Pin	I _{SD}	IC disabled, V _{IN} = 4.5V		0.8	3	μA
		IC disabled, V _{IN} = 22V		4.4	8	
Leakage Current of Low-side MOSFET	I _{LS_LKG}	IC disabled, V _{IN} = 22V, V _{OUT} = V _{SW} = 28.5V		0.1	6	μA
Output Voltage						
Output Voltage Range	V _{OUT}		9.5		28.5	V
Output Over-Voltage Protection Threshold	V _{OV}	V _{IN} = 5V, V _{OUT} rising, T _J = +25°C	29.2	30.2	31.2	V
Power Switches						
High-side MOSFET On-Resistance	R _{DS(on)_HS}	V _{CC} = 5V, T _J = +25°C		31	40	mΩ
Low-side MOSFET On-Resistance	R _{DS(on)_LS}	V _{CC} = 5V, T _J = +25°C		17	25	mΩ
Power Stage Trans-Conductance (peak current ratio with comp voltage)	G _m	V _{CC} = 5V		12.5		A/V
Current Limit						
Resistor-Programmable Current Limit	I _{LIM}	R _{LIM} = 107kΩ, T _J = +25°C	5.3	6.8	8.2	A
Voltage Reference						
Reference Voltage at FB Pin	V _{REF}	Forced PWM operation, T _J = +25°C	1.176	1.200	1.224	V
Leakage Current into FB Pin	I _{FB_LKG}			10	60	nA
EN Logic						
EN Pin Logic High Threshold	V _{EN_H}	V _{IN} = 5V			1.2	V
EN Pin Logic Low Threshold	V _{EN_L}	V _{IN} = 5V	0.4			V
EN Pin Pull-Down Resistor	R _{EN}			700		kΩ
Error Amplifier						
COMP Pin Output High Voltage	V _{COMP_H}	High threshold, V _{FB} = V _{REF} - 100mV, R _{LIM} = 107kΩ		1.57		V
COMP Pin Output Low Voltage	V _{COMP_L}	Low threshold, V _{FB} = V _{REF} + 100mV, R _{LIM} = 107kΩ		0.46		V
Error Amplifier Trans-Conductance	G _{mEA}	V _{COMP} = 1.2V		260		μS
COMP Pin Sink Current	I _{SINK}	V _{FB} = V _{REF} + 100mV, V _{COMP} = 1.2V		155		μA
COMP Pin Source Current	I _{SOURCE}	V _{FB} = V _{REF} - 100mV, V _{COMP} = 1.2V		25		μA
Soft-Start						
Startup Time	t _{STARTUP}			11		ms
Pre-Charge Time	t _{PRE_CHARGE}	T _J = +25°C	2	2.7	3.4	ms
Protection						
Thermal Shutdown Rising Threshold	T _{SD_R}	T _J rising		150		°C
Thermal Shutdown Falling Threshold	T _{SD_F}	T _J falling		130		°C
Waiting Time for Restart in Hiccup Mode	t _{HIC_OFF}			70		ms
Switching Frequency						
Switching Frequency	f _{SW}	R _{FREQ} = 330kΩ	400	500	600	kHz
Minimum On-Time	t _{ON_MIN}			180		ns

TYPICAL PERFORMANCE CHARACTERISTICS

At $T_J = +25^\circ\text{C}$, $V_{IN} = 5\text{V}$ and $V_{OUT} = 28.5\text{V}$, unless otherwise noted.

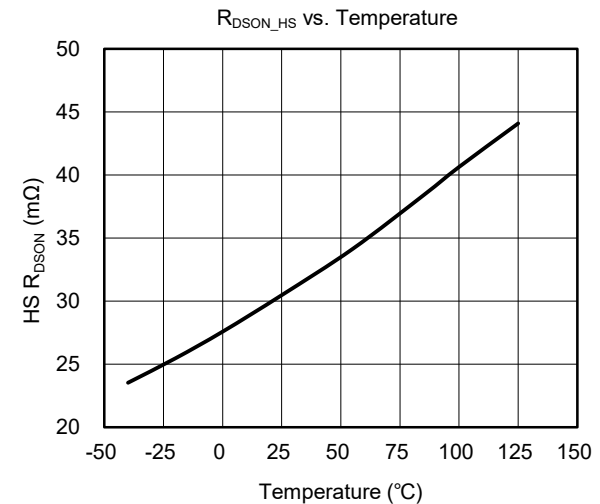
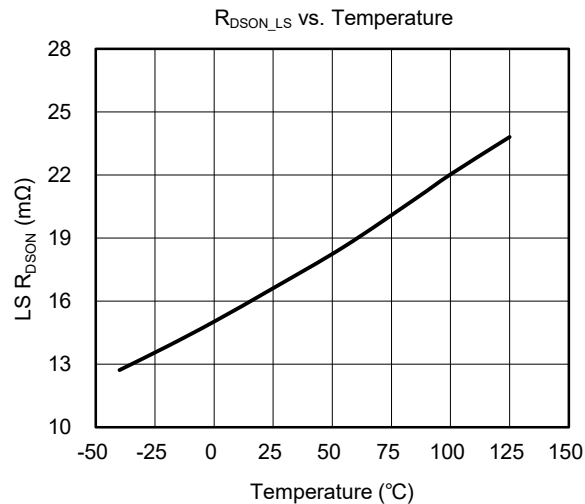
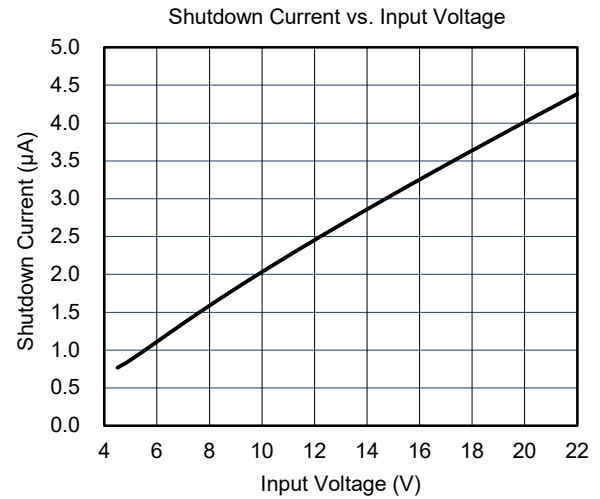
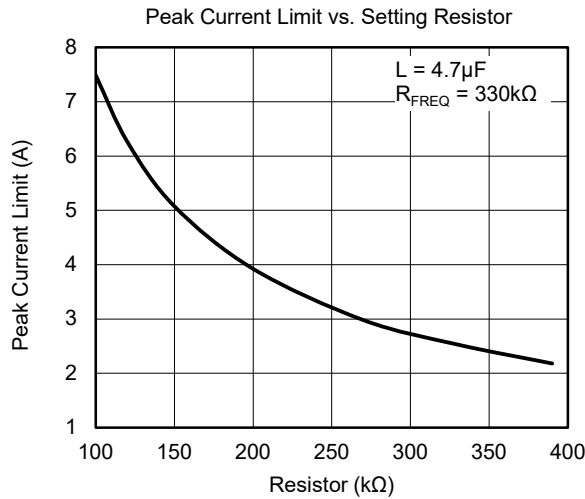
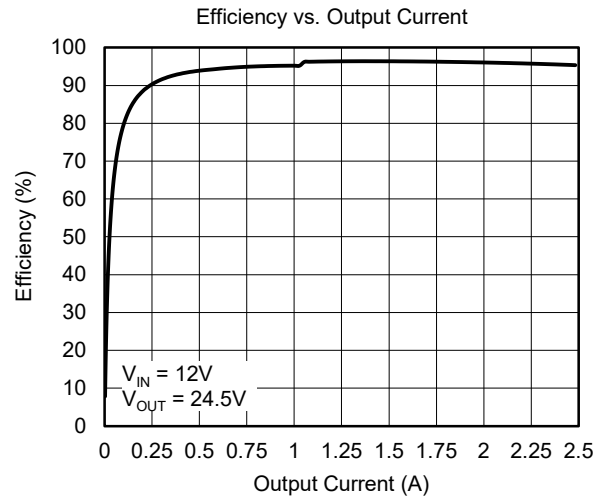
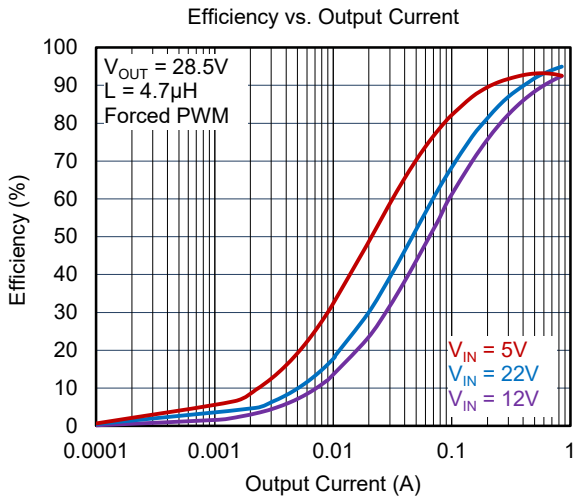

TYPICAL PERFORMANCE CHARACTERISTICS (continued)

At $T_J = +25^\circ\text{C}$, $V_{IN} = 5\text{V}$ and $V_{OUT} = 28.5\text{V}$, unless otherwise noted.

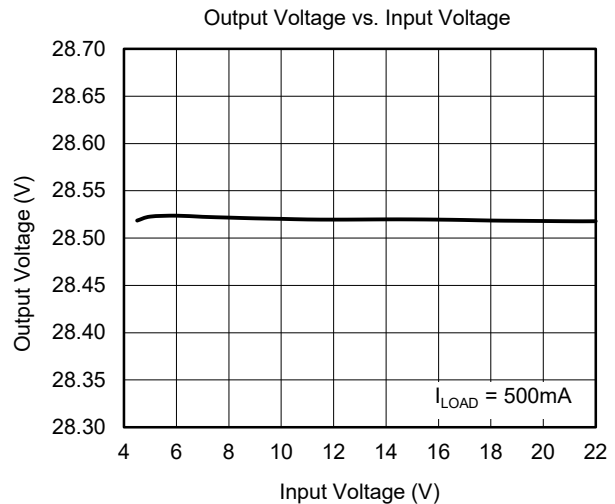
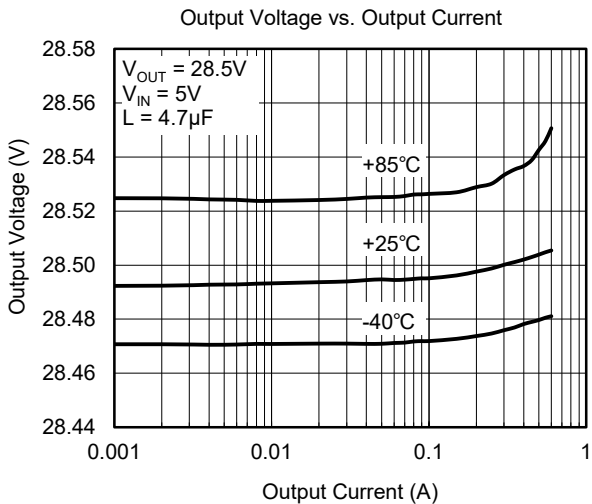
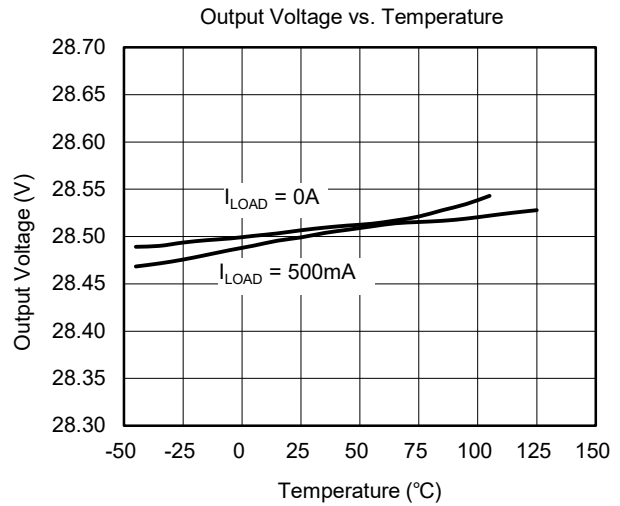
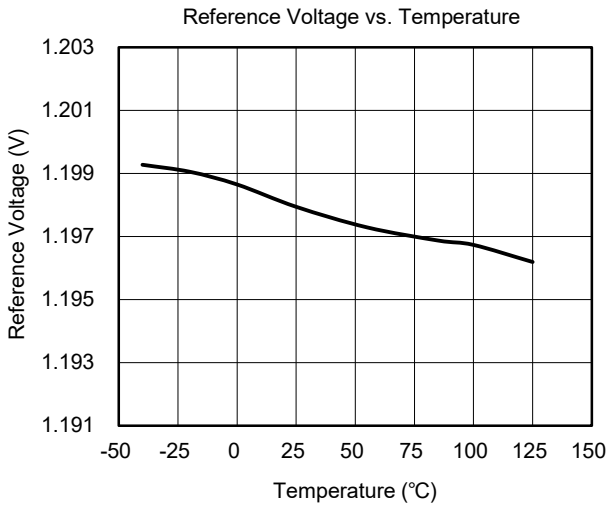
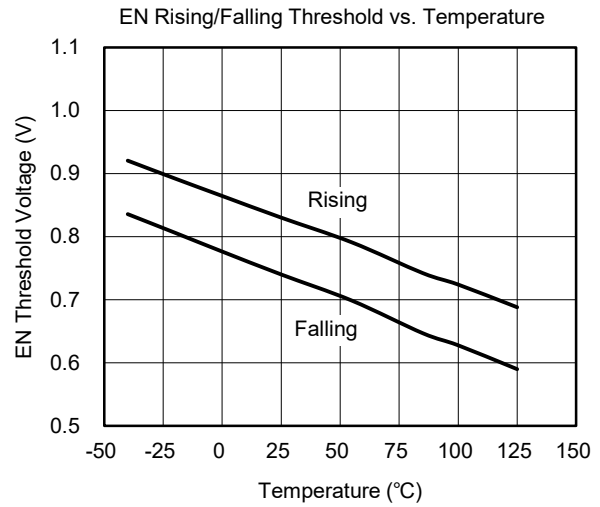
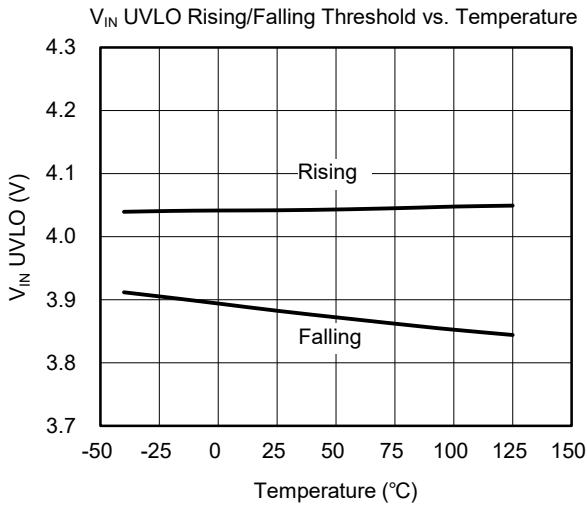

TYPICAL PERFORMANCE CHARACTERISTICS (continued)

At $T_J = +25^\circ\text{C}$, $V_{IN} = 5\text{V}$ and $V_{OUT} = 28.5\text{V}$, unless otherwise noted.

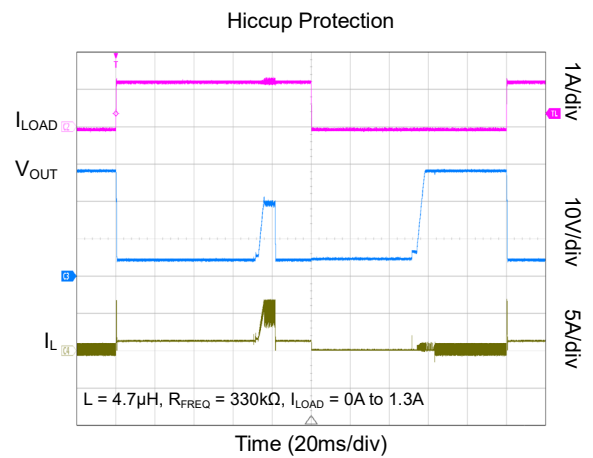
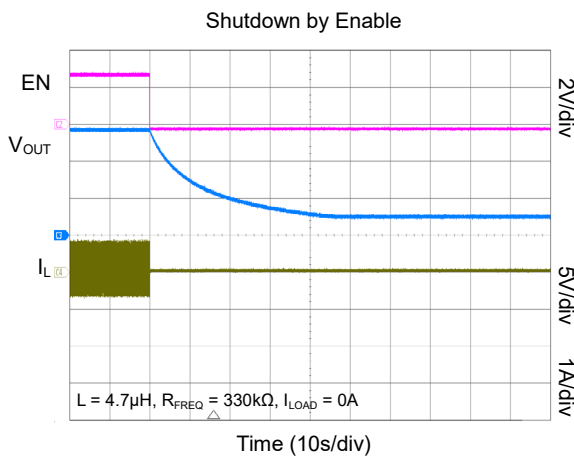
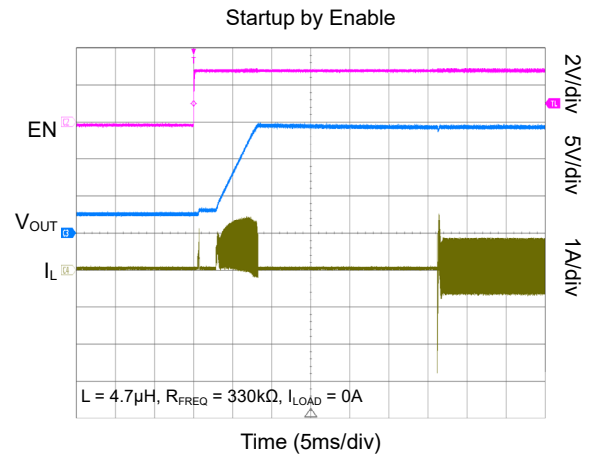
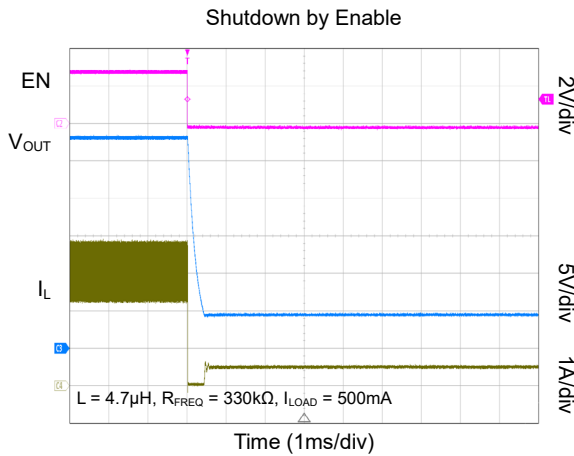
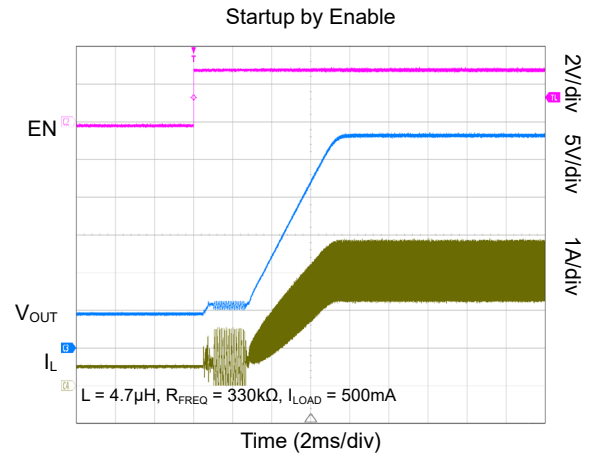
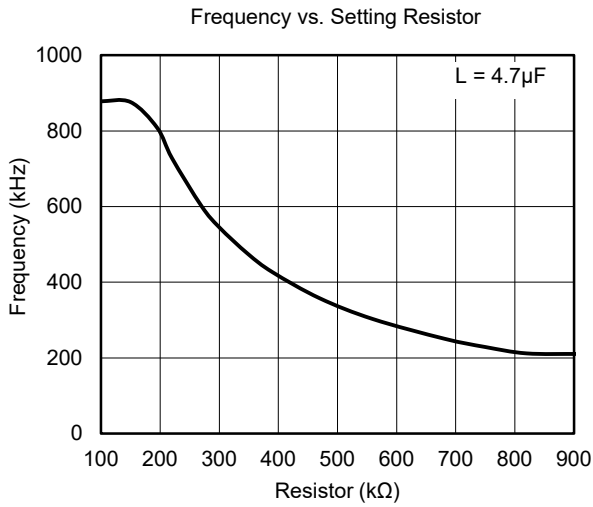

TYPICAL PERFORMANCE CHARACTERISTICS (continued)

At $T_J = +25^\circ\text{C}$, $V_{IN} = 5\text{V}$ and $V_{OUT} = 28.5\text{V}$, unless otherwise noted.

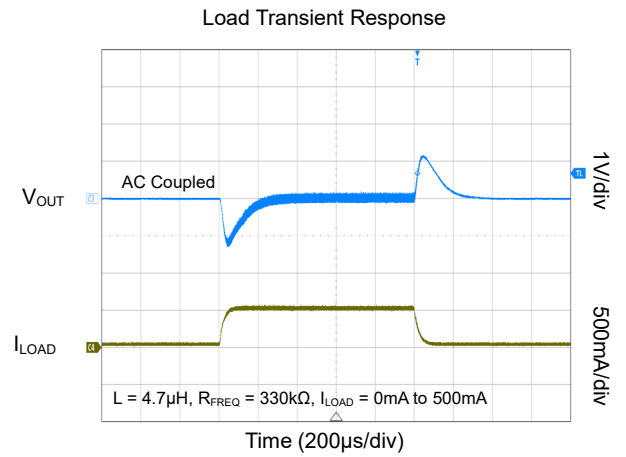
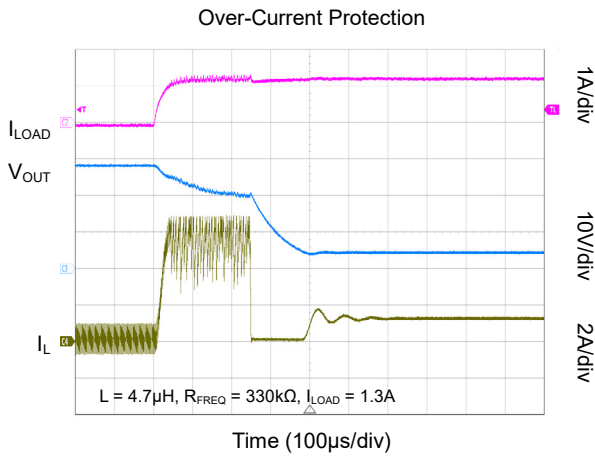
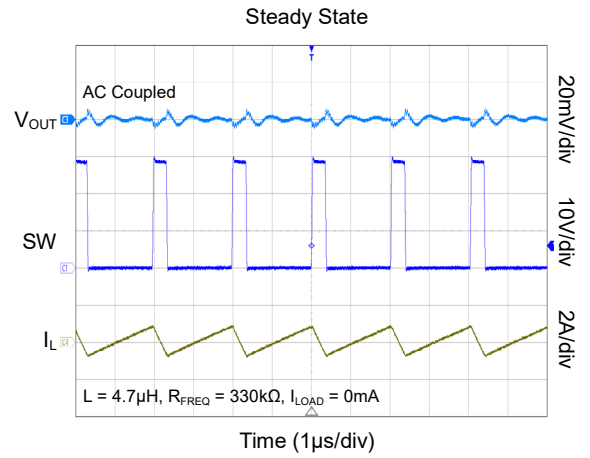
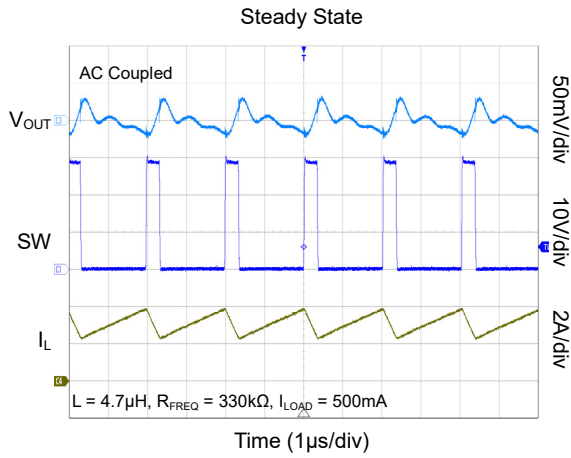

FUNCTIONAL BLOCK DIAGRAM

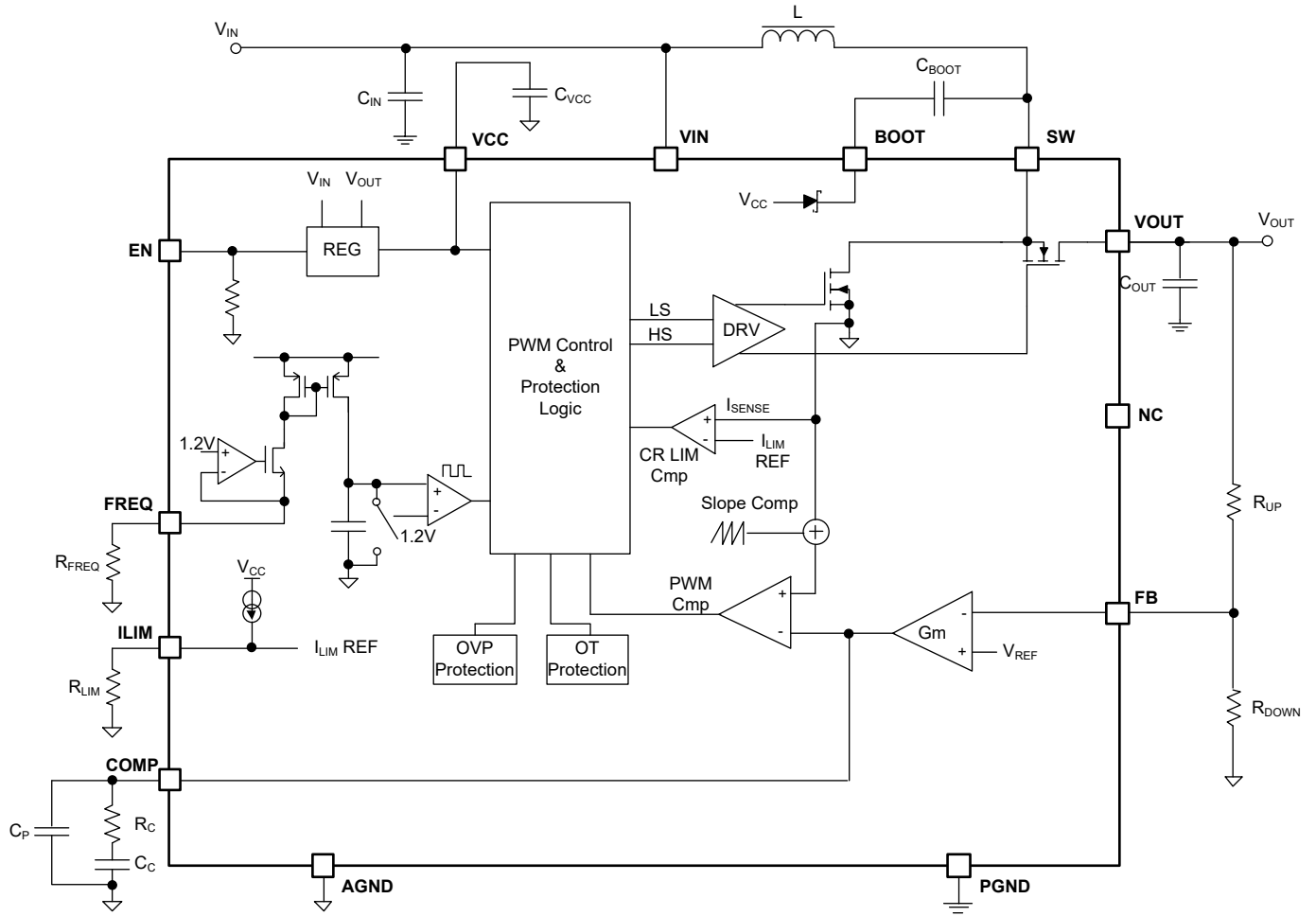

Figure 1. SGM6613A Block Diagram

DETAILED DESCRIPTION

The SGM6613A is a synchronous Boost converter integrating a 17mΩ low-side power switch and a 31mΩ high-side power switch. It is capable of delivering up to 7A peak current and up to 28.5V output voltage. In moderate to heavy load condition, the SGM6613A works at a fixed frequency PWM mode. In light load condition, the SGM6613A works in the forced PWM mode to avoid the acoustic noise and switching frequency interference. Excellent line and load transient response can be achieved with minimal output capacitance by applying a peak current control topology. The external loop compensation makes a wider range of inductor and output capacitor combinations available.

The SGM6613A supports the resistor-programmable switching frequency of up to 700kHz. In Boost operation, the device can avoid overload with the help of peak current control topology. In addition, during an over-current event, if the V_{OUT} drops and triggers hiccup mode, the SGM6613A enters into hiccup mode to provide a 70ms hiccup off-time to prevent the IC from overheating, thus triggering thermal shutdown. Device will recover automatically once the over-current condition is removed.

Input Under-Voltage Lockout (UVLO)

An under-voltage lockout circuit prevents operation of the device at input voltages below typical 3.94V with a hysteresis of 160mV. Therefore, if the input voltage rises and exceeds 4.1V (TYP), the device restarts.

Enable and Disable

When the input voltage exceeds minimum input voltage during startup and the EN voltage is higher than its logic high threshold, the SGM6613A is enabled. When the EN voltage is lower than its logic low threshold, the SGM6613A enters shutdown mode.

Startup

The SGM6613A implements the soft-start function to reduce the inrush current during startup. The device first charges the output voltage to $1.1 \times V_{IN}$ with the fixed 500kHz switching frequency during pre-charge phase. After the pre-charge phase (2.7ms, TYP), the output voltage will rise gradually and linearly to the target

value. The soft-start time is typically 11ms. Then, the switching frequency is set by the resistor connected through the FREQ pin.

Adjustable Peak Current Limit

To avoid accidental large peak current, an internal cycle-by-cycle current limit is adopted.

Connecting a resistor to the ILIM pin can set the peak current limit. Calculate the correct resistor value according to Equation 1 as below:

$$R_{LIM} = \frac{730}{I_{LIM}} \quad (1)$$

where:

R_{LIM} is the resistor used to set the current limit (kΩ).
 I_{LIM} is peak current limit (A).

For example, a 107kΩ resistor gives a 6.8A peak current limit.

Adjustable Switching Frequency

The SGM6613A has an adjustable switching frequency up to 700kHz. The switching frequency is set by an external resistor (R_{FREQ}) connected between the FREQ pin and AGND pin. Do not leave the FREQ pin floating. The resistor value is calculated by equations as follows.

$$T = \frac{1}{f_{FREQ}} = k \times C_{FREQ} \times R_{FREQ} + t_{DELAY} \quad (2)$$

$$R_{FREQ} = \frac{\frac{1}{f_{FREQ}} - t_{DELAY}}{k \times C_{FREQ}} \quad (3)$$

where:

$t_{DELAY} = 200\text{ns}$, $k = 3$ and $C_{FREQ} = 1.8\text{pF}$.

For example, when R_{FREQ} is 330kΩ, the frequency is 500kHz. If the frequency is set to more than 500kHz, lower inductance is recommended such that 1.8μH inductance is selected for 700kHz.

DETAILED DESCRIPTION (continued)

Start-up with Pre-biased Output

The low-side switch is prohibited from turning on and discharging the output if a pre-biased voltage is sensed on the output before start-up. As long as the internal soft-start voltage is higher than V_{FB} , the low-side switch is allowed to sink current to have a monotonic start-up with pre-biased output.

Bootstrap Voltage (BOOT)

A small ceramic capacitor between the BOOT pin and the SW pin provides gate current to charge the gate of the high-side MOSFET device during the on-time of each cycle and to charge the bootstrap capacitor. The value of this capacitor is recommended to be above $0.1\mu\text{F}$.

Device Functional Modes

The synchronous Boost converter SGM6613A operates at a constant frequency PWM mode in moderate to heavy load condition. The low-side N-MOSFET switch is turned on at the start of a cycle, and the inductor current increases to a peak current determined by the EA. After the peak current is reached, the current comparator trips, and it disables the low-side N-MOSFET switch and the inductor current goes through the body diode of the high-side N-MOSFET in a dead-time duration. After the dead-time duration, the high-side N-MOSFET switch is turned on. Because the output voltage is larger than the input voltage, the inductor current decreases. After a short dead-time duration, the low-side switch is turned on again and the switching cycle is repeated.

To avoid sub-harmonic oscillation, the SGM6613A has internal slope compensation.

In the forced PWM mode, the SGM6613A keeps the switching frequency constant in light load condition. As the load current reduces, the output of the internal error amplifier also decreases. Thus, the inductor current limit is lowered and less power is delivered from input to output. When the output current is reduced further, the current through the inductor will decrease to zero during the off-time. Even if the current through the MOSFET becomes negative, the high-side MOSFET will not turn off.

This mode is good for mitigating the acoustic noise and switching frequency interference at the light load.

When V_{OUT} is close to V_{IN} , the Boost converter cannot support the duty cycle anymore. It enables built-in Diode mode which enables the converter to regulate the output voltage. When operating in Diode mode, the converter's rectifier switch stops switching to regulate the output voltage. The efficiency during Diode mode operation is reduced so that it is recommended that V_{IN} should be at least 5V lower than V_{OUT} .

Over-Voltage Protection (OVP)

The SGM6613A provides 30.2V (TYP) OVP threshold. The device stops switching immediately until the voltage at the VOUT pin drops 600mV below the output OVP threshold. The OVP circuitry monitors the output voltage (V_{OUT}) and protects VOUT and SW from exceeding safe operating voltages.

Thermal Shutdown

To prevent thermal damage, the device has an internal temperature monitor. If the die temperature exceeds $+150^{\circ}\text{C}$ (TYP), the device stops switching. Once the temperature drops below $+130^{\circ}\text{C}$ (TYP), the device resumes operation.

APPLICATION INFORMATION

Typical Application

The application described is for 5V input, 28.5V output converter.

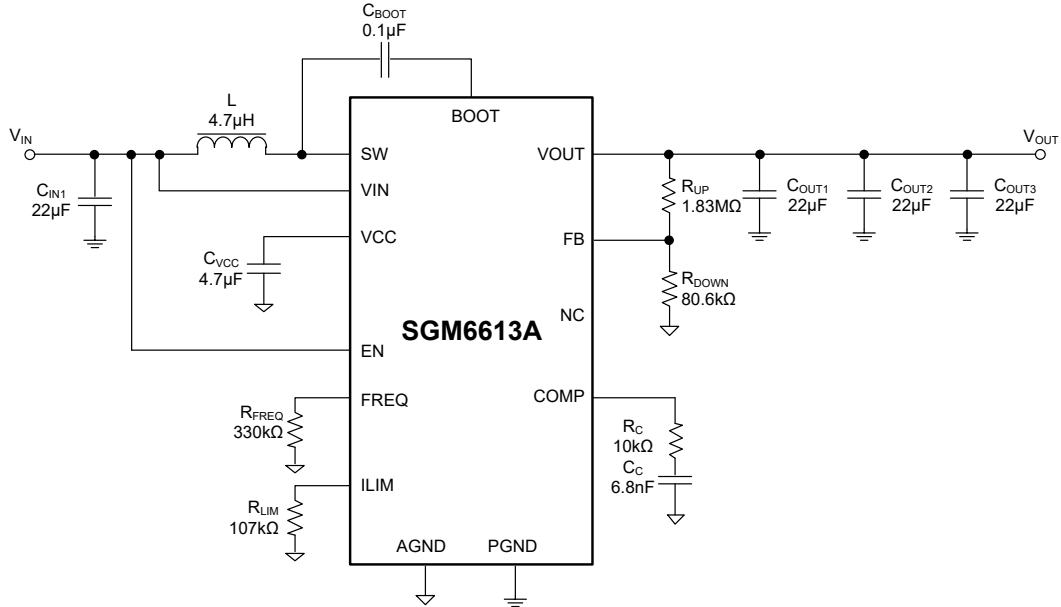

Figure 2. SGM6613A 28.5V Output

Design Requirements

Table 1 shows the design parameters in this design.

Table 1. Design Parameters

Parameter	Value
Input Voltage Range	4.5V to 22V
Output Voltage	28.5V
Output Ripple Voltage	±3%
Output Current Rating	0.5A
Operating Frequency	500kHz

Table 2. Recommended Inductors for SGM6613A

Part Number	L (µH)	DCR TYP (mΩ)	Saturation Current/Heat Rating Current (A)	Size (L × W × H mm)	Manufacturer
744325180	1.8	3.5	18	5 × 10 × 4	Würth
74437368033	3.3	11.8	23/8	10 × 10 × 3.8	Würth
DFEH10040D-3R3M#	3.3	12	10/10	10.9 × 10 × 4	Murata/TOKO
74439369047	4.7	5.4	27/13.5	11.6 × 10.5 × 8.8	Würth
74437368068	6.8	17.5	14	11 × 10 × 3.8	Würth
74437368100	10	27	12.5	11 × 10 × 3.8	Würth

Table 3. Recommended Capacitors for SGM6613A

Designator	Qty	Value	Description	Package	Part Number	Manufacturer
CIN	1	22µF	CAP, CERM, 22µF, 25V, ±10%, X5R, 1210	1210	GRM32ER61E226KE15L	Murata
COUT	3	22µF	CAP, CERM, 22µF, 35V, ±10%, X7R, 2220	2220	KRM55QR7YA226KH01L	Murata
CBOOT	1	0.1µF	CAP, CERM, 0.1µF, 16V, ±10%, X5R, 0402	0402	GRM155R61C104KA88D	Murata
CC	1	6.8nF	CAP, CERM, 6.8nF, 25V, ±10%, X7R, 0402	0402	GRM155R71E682KA01D	Murata
CVCC	1	4.7µF	CAP, CERM, 4.7µF, 10V, ±20%, X5R, 0402	0402	GRM155R61A475MEAAD	Murata

APPLICATION INFORMATION (continued)**Setting the Peak Current Limit**

The peak current limit of the SGM6613A is set by an external resistor. For setting a current limit of 6.8A, the resistor value is 107kΩ after calculation. Due to the distribution of the current limit, it is recommended to select a resistor about 10% less than the calculated value for safety. Here, 93.6kΩ resistor is a preferable choice.

Setting the Output Voltage

The output voltage is set by a resistor divider network. Calculate the output voltage by Equation 4:

$$V_{OUT} = V_{FB} \times \left(1 + \frac{R_{UP}}{R_{DOWN}} \right) \quad (4)$$

where:

V_{OUT} is the output voltage.

R_{UP} is the top divider resistor.

R_{DOWN} is the bottom divider resistor.

For setting an output voltage of 28.5V, select R_{DOWN} to be approximately 80.6kΩ, calculated by Equation 4, and R_{UP} is 1.83MΩ.

Selecting the Output Capacitors

It is recommended to use 3 × 22μF X5R or X7R MLCC capacitors connected in parallel for most applications. Refer to Table 3.

Selecting the Input Capacitor

A 22μF input capacitor is enough for most applications. To reduce the input current ripple, larger values may also be allowed. See Table 3.

Selecting the Bootstrap Capacitor

A 0.047μF ~ 0.1μF capacitor value range is recommended for bootstrap capacitor. And 0.1μF is used in this design. Refer to Table 3.

VCC Capacitor

The value of C_{VCC} should be at least 10 times larger than the value of C_{BOOT} . A 1μF ~ 4.7μF capacitor value range is recommended for C_{VCC} . A value of 4.7μF is recommended in this example, please see Table 3.

Layout Guidelines

As for all switching power supplies, especially those high frequency and high current ones, layout is an important design step. Poor layout could result in system instability, EMI failure, and device damage. Therefore, use wide and short traces for high current paths. Thus, place input capacitor as close to the VIN pin and GND pin as possible. If possible choose higher capacitance value for C_{IN} . The SW pin carries high current with fast rising and falling edges, therefore, all connections to the SW pin should be kept as short and wide as possible. The output capacitor C_{OUT} (3 × 22μF) should be put close to VOUT pin. It is beneficial to have the ground of C_{OUT} close to the PGND pin since there is large ground return current flowing between them. It is also recommended to place an additional 1μF ceramic capacitor directly across the VOUT and PGND pins. Sensitive signals like FB, COMP traces must be placed away from SW trace. The ground of these signals should be connected to GND pin and separated with power ground.

REVISION HISTORY

NOTE: Page numbers for previous revisions may differ from page numbers in the current version.

SEPTEMBER 2023 – REV.A.3 to REV.A.4	Page
Added the performance of Efficiency vs. Output Current.....	5
JUNE 2022 – REV.A.2 to REV.A.3	Page
Updated Detailed Description and Application Information sections.....	10, 11, 13
NOVEMBER 2021 – REV.A.1 to REV.A.2	Page
Updated the Recommended Operating Conditions section.....	2
JUNE 2021 – REV.A to REV.A.1	Page
Updated Table 3	12
Changes from Original (MARCH 2021) to REV.A	Page
Changed from product preview to production data.....	All

PACKAGE OUTLINE DIMENSIONS

TQFN-3x3.5-13L

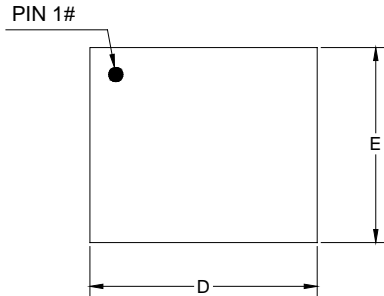

TOP VIEW

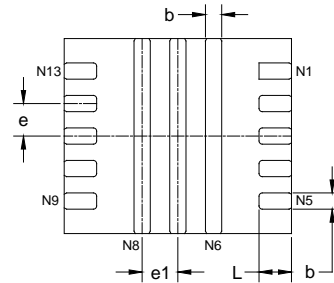

BOTTOM VIEW

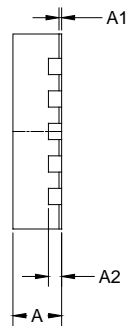

SIDE VIEW

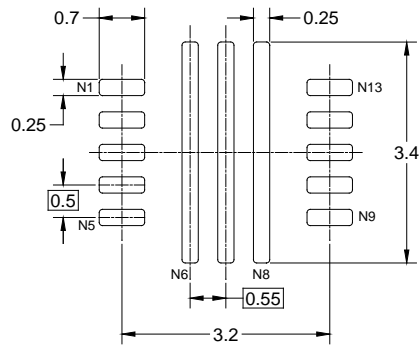

RECOMMENDED LAND PATTERN (Unit: mm)

Symbol	Dimensions In Millimeters		
	MIN	MOD	MAX
A	0.700	0.750	0.800
A1	0.000	0.020	0.050
A2	0.203 REF		
b	0.200	0.250	0.300
D	3.450	3.500	3.550
E	2.950	3.000	3.050
L	0.450	0.500	0.550
e	0.500 BSC		
e1	0.550 BSC		

NOTE: This drawing is subject to change without notice.

PACKAGE INFORMATION

TAPE AND REEL INFORMATION

REEL DIMENSIONS



TAPE DIMENSIONS



NOTE: The picture is only for reference. Please make the object as the standard.

KEY PARAMETER LIST OF TAPE AND REEL

Package Type	Reel Diameter	Reel Width W1 (mm)	A0 (mm)	B0 (mm)	K0 (mm)	P0 (mm)	P1 (mm)	P2 (mm)	W (mm)	Pin1 Quadrant
TQFN-3×3.5-13L	13"	12.4	3.30	3.80	1.05	4.0	8.0	2.0	12.0	Q2

DD0001

PACKAGE INFORMATION

CARTON BOX DIMENSIONS



NOTE: The picture is only for reference. Please make the object as the standard.

KEY PARAMETER LIST OF CARTON BOX

Reel Type	Length (mm)	Width (mm)	Height (mm)	Pizza/Carton
13"	386	280	370	5

DD0002