

GENERAL DESCRIPTION

The SGM2047 is an ultra-low quiescent current, fast transient response, high accuracy and low dropout voltage linear regulator. It is capable of supplying 200mA output current with typical dropout voltage of only 135mV. The operating input voltage range is from 1.7V to 5.5V and output voltage range is from 0.6V to 3.6V.

Other features include logic-controlled shutdown mode, short-circuit current limit and thermal shutdown protection. The SGM2047A has automatic discharge function to quickly discharge V_{OUT} in the disabled status.

The SGM2047 is suitable for application which needs ultra-low quiescent current and fast transient response power supply, such as power supply of low power wireless in wearable equipment.

The SGM2047 is available in Green XTDFN-1×1-4L and SOT-23-5 packages. It operates over an operating temperature range of -40°C to +125°C.

FEATURES

- **Operating Input Voltage Range: 1.7V to 5.5V**
- **Fixed Outputs of 0.6V, 0.7V, 0.8V, 0.9V, 1.0V, 1.1V, 1.2V, 1.5V, 1.8V, 2.5V, 2.8V, 3.0V, 3.3V and 3.6V**
- **Output Voltage Accuracy: $\pm 1\%$ (TYP) at +25°C**
- **Low Dropout: 135mV (TYP) at 200mA**
- **Ultra-Low Quiescent Current: 0.6 μ A (TYP)**
- **Current Limiting and Thermal Protection**
- **Stable with Small Case Size Ceramic Capacitors**
- **Shutdown Supply Current: 0.065 μ A (TYP)**
- **SGM2047A: With Output Active Discharge**
- **SGM2047B: Without Output Active Discharge**
- **-40°C to +125°C Operating Temperature Range**
- **Available in Green XTDFN-1×1-4L and SOT-23-5 Packages**

APPLICATIONS

Battery-Powered System
 Portable Computing Equipment
 Wearable Equipment
 Low Power Wireless

TYPICAL APPLICATION

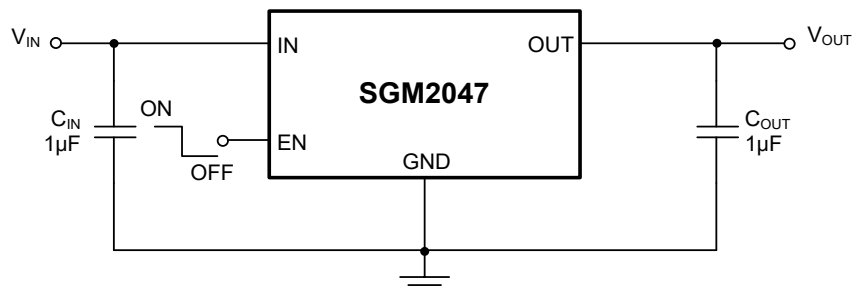

Figure 1. Typical Application Circuit

PACKAGE/ORDERING INFORMATION

MODEL	PACKAGE DESCRIPTION	SPECIFIED TEMPERATURE RANGE	ORDERING NUMBER	PACKAGE MARKING	PACKING OPTION
SGM2047A-0.6	XTDFN-1×1-4L	-40°C to +125°C	SGM2047A-0.6XXDH4G/TR	XJ	Tape and Reel, 10000
SGM2047A-0.7	XTDFN-1×1-4L	-40°C to +125°C	SGM2047A-0.7XXDH4G/TR	0I	Tape and Reel, 10000
SGM2047A-0.8	XTDFN-1×1-4L	-40°C to +125°C	SGM2047A-0.8XXDH4G/TR	0J	Tape and Reel, 10000
SGM2047A-0.9	XTDFN-1×1-4L	-40°C to +125°C	SGM2047A-0.9XXDH4G/TR	0K	Tape and Reel, 10000
SGM2047A-1.0	XTDFN-1×1-4L	-40°C to +125°C	SGM2047A-1.0XXDH4G/TR	0L	Tape and Reel, 10000
SGM2047A-1.1	XTDFN-1×1-4L	-40°C to +125°C	SGM2047A-1.1XXDH4G/TR	0M	Tape and Reel, 10000
SGM2047A-1.2	XTDFN-1×1-4L	-40°C to +125°C	SGM2047A-1.2XXDH4G/TR	XK	Tape and Reel, 10000
SGM2047A-1.5	XTDFN-1×1-4L	-40°C to +125°C	SGM2047A-1.5XXDH4G/TR	0N	Tape and Reel, 10000
SGM2047A-1.8	XTDFN-1×1-4L	-40°C to +125°C	SGM2047A-1.8XXDH4G/TR	0P	Tape and Reel, 10000
SGM2047A-2.5	XTDFN-1×1-4L	-40°C to +125°C	SGM2047A-2.5XXDH4G/TR	0Q	Tape and Reel, 10000
SGM2047A-2.8	XTDFN-1×1-4L	-40°C to +125°C	SGM2047A-2.8XXDH4G/TR	0R	Tape and Reel, 10000
SGM2047A-3.0	XTDFN-1×1-4L	-40°C to +125°C	SGM2047A-3.0XXDH4G/TR	0S	Tape and Reel, 10000
SGM2047A-3.3	XTDFN-1×1-4L	-40°C to +125°C	SGM2047A-3.3XXDH4G/TR	XL	Tape and Reel, 10000
SGM2047A-3.6	XTDFN-1×1-4L	-40°C to +125°C	SGM2047A-3.6XXDH4G/TR	XM	Tape and Reel, 10000
SGM2047B-0.6	XTDFN-1×1-4L	-40°C to +125°C	SGM2047B-0.6XXDH4G/TR	0T	Tape and Reel, 10000
SGM2047B-0.7	XTDFN-1×1-4L	-40°C to +125°C	SGM2047B-0.7XXDH4G/TR	0U	Tape and Reel, 10000
SGM2047B-0.8	XTDFN-1×1-4L	-40°C to +125°C	SGM2047B-0.8XXDH4G/TR	0V	Tape and Reel, 10000
SGM2047B-0.9	XTDFN-1×1-4L	-40°C to +125°C	SGM2047B-0.9XXDH4G/TR	0W	Tape and Reel, 10000
SGM2047B-1.0	XTDFN-1×1-4L	-40°C to +125°C	SGM2047B-1.0XXDH4G/TR	0X	Tape and Reel, 10000
SGM2047B-1.1	XTDFN-1×1-4L	-40°C to +125°C	SGM2047B-1.1XXDH4G/TR	0Y	Tape and Reel, 10000
SGM2047B-1.2	XTDFN-1×1-4L	-40°C to +125°C	SGM2047B-1.2XXDH4G/TR	0Z	Tape and Reel, 10000
SGM2047B-1.5	XTDFN-1×1-4L	-40°C to +125°C	SGM2047B-1.5XXDH4G/TR	1G	Tape and Reel, 10000
SGM2047B-1.8	XTDFN-1×1-4L	-40°C to +125°C	SGM2047B-1.8XXDH4G/TR	1H	Tape and Reel, 10000
SGM2047B-2.5	XTDFN-1×1-4L	-40°C to +125°C	SGM2047B-2.5XXDH4G/TR	1J	Tape and Reel, 10000
SGM2047B-2.8	XTDFN-1×1-4L	-40°C to +125°C	SGM2047B-2.8XXDH4G/TR	1K	Tape and Reel, 10000
SGM2047B-3.0	XTDFN-1×1-4L	-40°C to +125°C	SGM2047B-3.0XXDH4G/TR	1L	Tape and Reel, 10000
SGM2047B-3.3	XTDFN-1×1-4L	-40°C to +125°C	SGM2047B-3.3XXDH4G/TR	1M	Tape and Reel, 10000
SGM2047B-3.6	XTDFN-1×1-4L	-40°C to +125°C	SGM2047B-3.6XXDH4G/TR	1N	Tape and Reel, 10000

PACKAGE/ORDERING INFORMATION (continued)

MODEL	PACKAGE DESCRIPTION	SPECIFIED TEMPERATURE RANGE	ORDERING NUMBER	PACKAGE MARKING	PACKING OPTION
SGM2047A-0.6	SOT-23-5	-40°C to +125°C	SGM2047A-0.6XN5G/TR	SVWXX	Tape and Reel, 3000
SGM2047A-0.7	SOT-23-5	-40°C to +125°C	SGM2047A-0.7XN5G/TR	G3YXX	Tape and Reel, 3000
SGM2047A-0.8	SOT-23-5	-40°C to +125°C	SGM2047A-0.8XN5G/TR	G3ZXX	Tape and Reel, 3000
SGM2047A-0.9	SOT-23-5	-40°C to +125°C	SGM2047A-0.9XN5G/TR	G4BXX	Tape and Reel, 3000
SGM2047A-1.0	SOT-23-5	-40°C to +125°C	SGM2047A-1.0XN5G/TR	G4GXX	Tape and Reel, 3000
SGM2047A-1.1	SOT-23-5	-40°C to +125°C	SGM2047A-1.1XN5G/TR	G4HXX	Tape and Reel, 3000
SGM2047A-1.2	SOT-23-5	-40°C to +125°C	SGM2047A-1.2XN5G/TR	SVXXX	Tape and Reel, 3000
SGM2047A-1.5	SOT-23-5	-40°C to +125°C	SGM2047A-1.5XN5G/TR	G4IXX	Tape and Reel, 3000
SGM2047A-1.8	SOT-23-5	-40°C to +125°C	SGM2047A-1.8XN5G/TR	G4JXX	Tape and Reel, 3000
SGM2047A-2.5	SOT-23-5	-40°C to +125°C	SGM2047A-2.5XN5G/TR	G4KXX	Tape and Reel, 3000
SGM2047A-2.8	SOT-23-5	-40°C to +125°C	SGM2047A-2.8XN5G/TR	G4LXX	Tape and Reel, 3000
SGM2047A-3.0	SOT-23-5	-40°C to +125°C	SGM2047A-3.0XN5G/TR	G4MXX	Tape and Reel, 3000
SGM2047A-3.3	SOT-23-5	-40°C to +125°C	SGM2047A-3.3XN5G/TR	SVYXX	Tape and Reel, 3000
SGM2047A-3.6	SOT-23-5	-40°C to +125°C	SGM2047A-3.6XN5G/TR	SVZXX	Tape and Reel, 3000
SGM2047B-0.6	SOT-23-5	-40°C to +125°C	SGM2047B-0.6XN5G/TR	G4NXX	Tape and Reel, 3000
SGM2047B-0.7	SOT-23-5	-40°C to +125°C	SGM2047B-0.7XN5G/TR	G4PXX	Tape and Reel, 3000
SGM2047B-0.8	SOT-23-5	-40°C to +125°C	SGM2047B-0.8XN5G/TR	G4QXX	Tape and Reel, 3000
SGM2047B-0.9	SOT-23-5	-40°C to +125°C	SGM2047B-0.9XN5G/TR	G4RXX	Tape and Reel, 3000
SGM2047B-1.0	SOT-23-5	-40°C to +125°C	SGM2047B-1.0XN5G/TR	G4SXX	Tape and Reel, 3000
SGM2047B-1.1	SOT-23-5	-40°C to +125°C	SGM2047B-1.1XN5G/TR	G4TXX	Tape and Reel, 3000
SGM2047B-1.2	SOT-23-5	-40°C to +125°C	SGM2047B-1.2XN5G/TR	G4UXX	Tape and Reel, 3000
SGM2047B-1.5	SOT-23-5	-40°C to +125°C	SGM2047B-1.5XN5G/TR	G4VXX	Tape and Reel, 3000
SGM2047B-1.8	SOT-23-5	-40°C to +125°C	SGM2047B-1.8XN5G/TR	G4WXX	Tape and Reel, 3000
SGM2047B-2.5	SOT-23-5	-40°C to +125°C	SGM2047B-2.5XN5G/TR	G4XXX	Tape and Reel, 3000
SGM2047B-2.8	SOT-23-5	-40°C to +125°C	SGM2047B-2.8XN5G/TR	G4YXX	Tape and Reel, 3000
SGM2047B-3.0	SOT-23-5	-40°C to +125°C	SGM2047B-3.0XN5G/TR	G4ZXX	Tape and Reel, 3000
SGM2047B-3.3	SOT-23-5	-40°C to +125°C	SGM2047B-3.3XN5G/TR	G5GXX	Tape and Reel, 3000
SGM2047B-3.6	SOT-23-5	-40°C to +125°C	SGM2047B-3.6XN5G/TR	G5HXX	Tape and Reel, 3000

MARKING INFORMATION

NOTE: XX = Date Code.

SOT-23-5

YYY X X

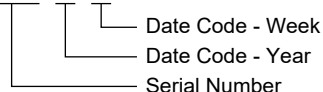

XTDFN-1×1-4L

YY

Serial Number

Green (RoHS & HSF): SG Micro Corp defines "Green" to mean Pb-Free (RoHS compatible) and free of halogen substances. If you have additional comments or questions, please contact your SGMICRO representative directly.

ABSOLUTE MAXIMUM RATINGS

IN to GND	-0.3V to 6V
OUT to GND	-0.3V to (V _{IN} + 0.3V)
EN to GND.....	-0.3V to 6V
Package Thermal Resistance	
XTDFN-1×1-4L, θ _{JA}	170°C/W
XTDFN-1×1-4L, θ _{JB}	105°C/W
XTDFN-1×1-4L, θ _{JC(TOP)}	130°C/W
XTDFN-1×1-4L, θ _{JC(BOT)}	98°C/W
SOT-23-5, θ _{JA}	167°C/W
SOT-23-5, θ _{JB}	56°C/W
SOT-23-5, θ _{JC}	79°C/W
Junction Temperature.....	+150°C
Storage Temperature Range	-65°C to +150°C
Lead Temperature (Soldering, 10s).....	+260°C
ESD Susceptibility	
HBM.....	8000V
CDM	1000V

RECOMMENDED OPERATING CONDITIONS

Input Voltage Range	1.7V to 5.5V
Input Effective Capacitance, C _{IN}	1µF (MIN)
Output Effective Capacitance, C _{OUT}	1µF to 10µF
Operating Junction Temperature Range.....	-40°C to +125°C

OVERSTRESS CAUTION

Stresses beyond those listed in Absolute Maximum Ratings may cause permanent damage to the device. Exposure to absolute maximum rating conditions for extended periods may affect reliability. Functional operation of the device at any conditions beyond those indicated in the Recommended Operating Conditions section is not implied.

ESD SENSITIVITY CAUTION

This integrated circuit can be damaged if ESD protections are not considered carefully. SGMICRO recommends that all integrated circuits be handled with appropriate precautions. Failure to observe proper handling and installation procedures can cause damage. ESD damage can range from subtle performance degradation to complete device failure. Precision integrated circuits may be more susceptible to damage because even small parametric changes could cause the device not to meet the published specifications.

DISCLAIMER

SG Micro Corp reserves the right to make any change in circuit design, or specifications without prior notice.

PIN CONFIGURATIONS

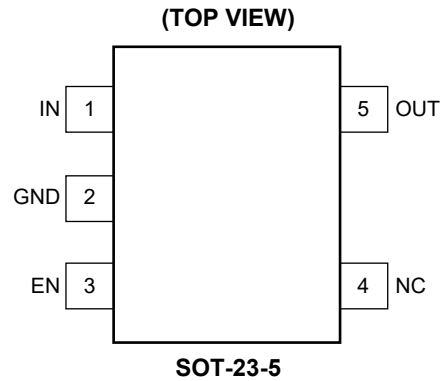
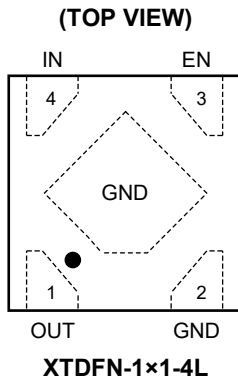

PIN DESCRIPTION

PIN		NAME	FUNCTION
XTDFN-1x1-4L	SOT-23-5		
1	5	OUT	Regulator Output Pin. It is recommended to use a ceramic capacitor with effective capacitance in the range of 1μF to 10μF to ensure stability. This ceramic capacitor should be placed as close as possible to OUT pin.
2	2	GND	Ground.
3	3	EN	Enable Pin. Drive EN high to turn on the regulator. Drive EN low to turn off the regulator. This pin must be pulled high by an external resistor connected to IN pin if EN pin is not used.
4	1	IN	Input Voltage Supply Pin. It is recommended to use a 1μF or larger ceramic capacitor from IN pin to ground to get good power supply decoupling. This ceramic capacitor should be placed as close as possible to IN pin.
-	4	NC	No Connection.
Exposed Pad	-	GND	Exposed Pad. Connect it to a large ground plane to maximize thermal performance. This pad is not an electrical connection point.

FUNCTIONAL BLOCK DIAGRAMS

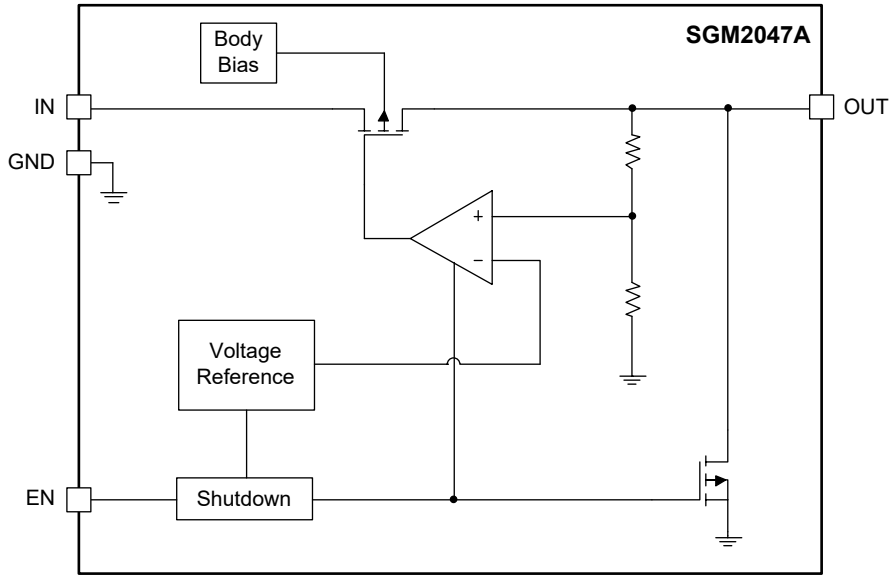

Figure 2. Block Diagram (SGM2047A)

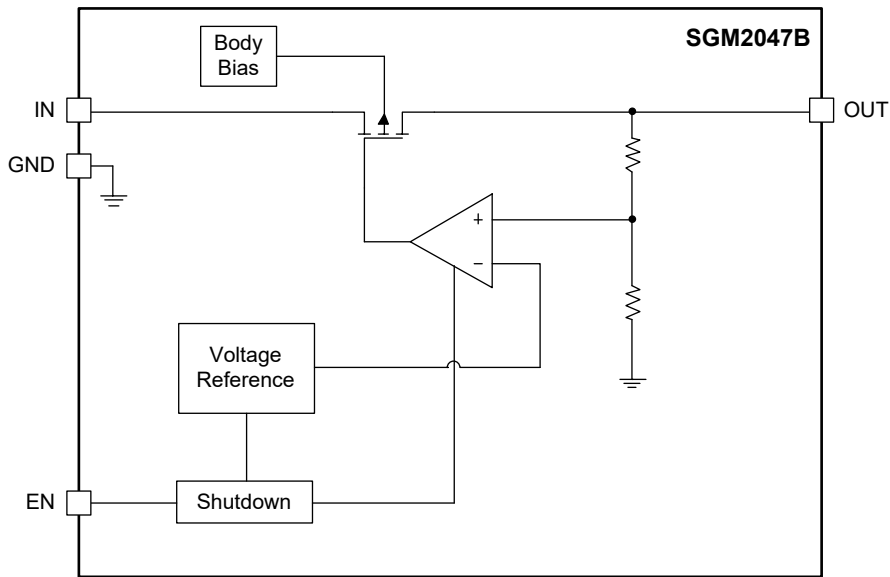

Figure 3. Block Diagram (SGM2047B)

ELECTRICAL CHARACTERISTICS

($V_{IN} = (V_{OUT} + 1V)$ or 1.7V (whichever is greater), $I_{OUT} = 1mA$, $C_{IN} = 1\mu F$, $C_{OUT} = 1\mu F$, typical values are at $T_J = +25^\circ C$, unless otherwise noted.)

PARAMETER	SYMBOL	CONDITIONS		MIN	TYP	MAX	UNITS	
Input Voltage Range	V_{IN}			1.7		5.5	V	
Output Voltage Accuracy	V_{OUT}	$T_J = +25^\circ C$		-1		1	%	
		$T_J = -40^\circ C$ to $+85^\circ C$		-2		2		
		$T_J = -40^\circ C$ to $+125^\circ C$		-3.5		3.5		
Line Regulation	$\frac{\Delta V_{OUT}}{\Delta V_{IN} \times V_{OUT}}$	$V_{IN} = (V_{OUT(NOM)} + 1V)$ or 1.7V to 5.5V, $I_{OUT} = 1mA$			0.01	0.25	%/V	
Load Regulation	$\frac{\Delta V_{OUT}}{\Delta I_{OUT} \times V_{OUT}}$	$I_{OUT} = 0mA$ to 200mA			0.003	0.03	%/mA	
Dropout Voltage	V_{DROP}	$I_{OUT} = 200mA$, when V_{OUT} falls to $V_{OUT(NOM)} \times 95\%$	$V_{OUT(NOM)} \leq 1.1V$		$1.9V - V_{OUT}$		mV	
			$V_{OUT(NOM)} = 1.2V$		545	720		
			$V_{OUT(NOM)} = 1.5V$		330	480		
			$V_{OUT(NOM)} = 1.8V$		255	380		
			$V_{OUT(NOM)} = 2.5V$		175	270		
			$V_{OUT(NOM)} = 2.8V$		160	250		
			$V_{OUT(NOM)} = 3V$		155	240		
			$V_{OUT(NOM)} = 3.3V$		145	220		
Output Current Limit	I_{LIMIT}	$V_{OUT(NOM)} \leq 1.1V$, $V_{IN} = V_{OUT(NOM)} + 1.2V$, $V_{OUT} = V_{OUT(NOM)} \times 90\%$		200			mA	
		$V_{OUT(NOM)} > 1.1V$, $V_{IN} = V_{OUT(NOM)} + 1V$, $V_{OUT} = V_{OUT(NOM)} \times 90\%$						
Short-Circuit Current Limit	I_{SHORT}	$V_{OUT} = 0V$			315		mA	
Quiescent Current	I_Q	No load	$T_J = -40^\circ C$ to $+85^\circ C$		0.6	1.2	μA	
			$T_J = -40^\circ C$ to $+125^\circ C$			2.5		
Shutdown Supply Current	I_{SHDN}	$V_{EN} = 0V$	$T_J = +25^\circ C$		0.065	0.15	μA	
			$T_J = -40^\circ C$ to $+85^\circ C$			0.26		
			$T_J = -40^\circ C$ to $+125^\circ C$			1		
EN Pin Threshold Voltage	V_{IH}	EN Input Voltage "H"		1.2			V	
	V_{IL}	EN Input Voltage "L"				0.4		
EN Pin Current	I_{EN}	$V_{IN} = V_{EN}$ to 5.5V			10		nA	
Output Active Discharge Resistance (SGM2047A Only)	R_{DIS}	$V_{IN} = 5.5V$, $V_{EN} = 0V$			80		Ω	
Power Supply Rejection Ratio	PSRR	$V_{OUT(NOM)} = 0.6V$, $V_{IN} = 1.7V$, $\Delta V_{RIPPLE} = 0.2V_{P-P}$, $f = 1kHz$	$I_{OUT} = 150mA$		42		dB	
			$I_{OUT} = 10mA$		64			
			$V_{OUT(NOM)} = 1.2V$, $V_{IN} = 2.2V$, $\Delta V_{RIPPLE} = 0.2V_{P-P}$, $f = 1kHz$	$I_{OUT} = 150mA$		57		
				$I_{OUT} = 10mA$		57		
			$V_{OUT(NOM)} = 3V$, $V_{IN} = 4V$, $\Delta V_{RIPPLE} = 0.2V_{P-P}$, $f = 1kHz$	$I_{OUT} = 150mA$		42		
				$I_{OUT} = 10mA$		42		
			$V_{OUT(NOM)} = 3.6V$, $V_{IN} = 4.6V$, $\Delta V_{RIPPLE} = 0.2V_{P-P}$, $f = 1kHz$	$I_{OUT} = 150mA$		43		
				$I_{OUT} = 10mA$		43		
Output Voltage Noise	e_n	$V_{IN} = 5.5V$, $I_{OUT} = 1mA$, $f = 100Hz$ to 1MHz	$V_{OUT(NOM)} = 0.6V$		47		μV_{RMS}	
			$V_{OUT(NOM)} = 1.2V$		62			
			$V_{OUT(NOM)} = 3V$		89			
			$V_{OUT(NOM)} = 3.3V$		92			
Thermal Shutdown Temperature	T_{SHDN}				150		$^\circ C$	
Thermal Shutdown Hysteresis	ΔT_{SHDN}				20		$^\circ C$	

TYPICAL PERFORMANCE CHARACTERISTICS

$T_J = +25^\circ\text{C}$, $V_{IN} = V_{OUT(NOM)} + 1\text{V}$, $C_{IN} = 1\mu\text{F}$, $C_{OUT} = 1\mu\text{F}$, unless otherwise noted.

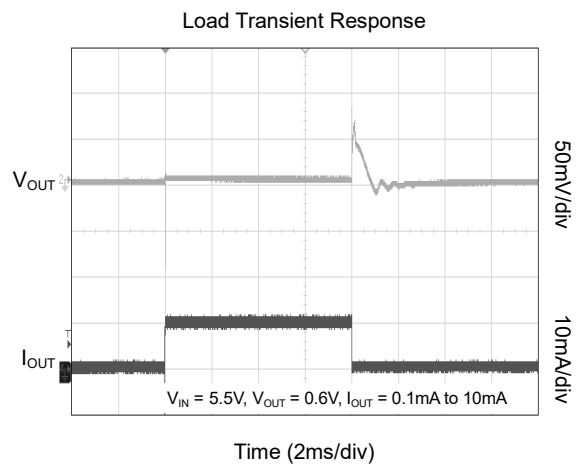
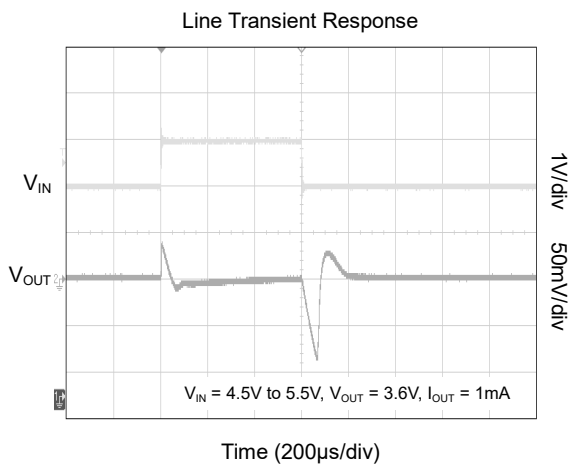
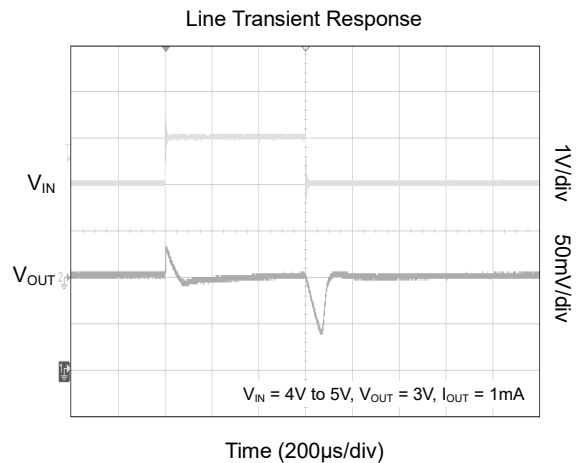
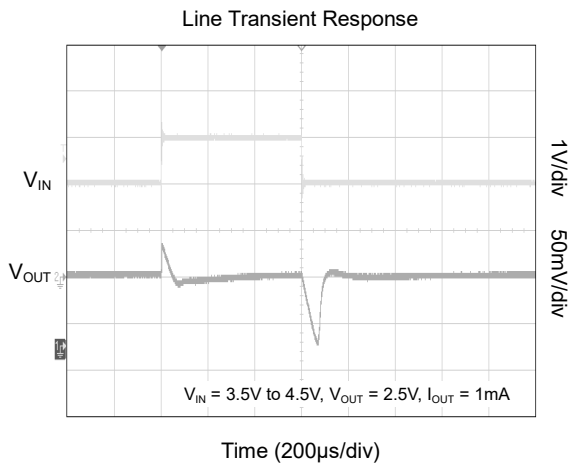
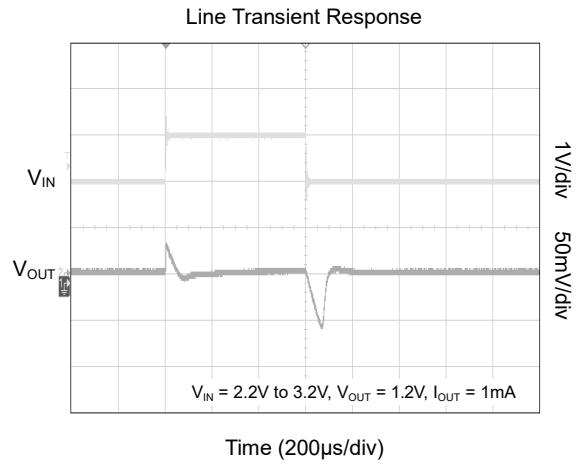
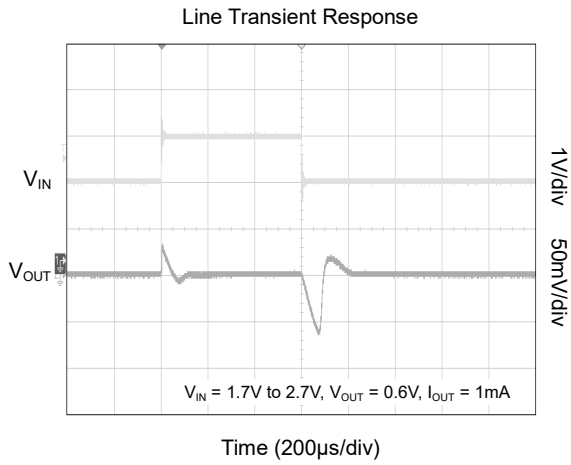

TYPICAL PERFORMANCE CHARACTERISTICS (continued)

$T_J = +25^\circ\text{C}$, $V_{IN} = V_{OUT(NOM)} + 1\text{V}$, $C_{IN} = 1\mu\text{F}$, $C_{OUT} = 1\mu\text{F}$, unless otherwise noted.

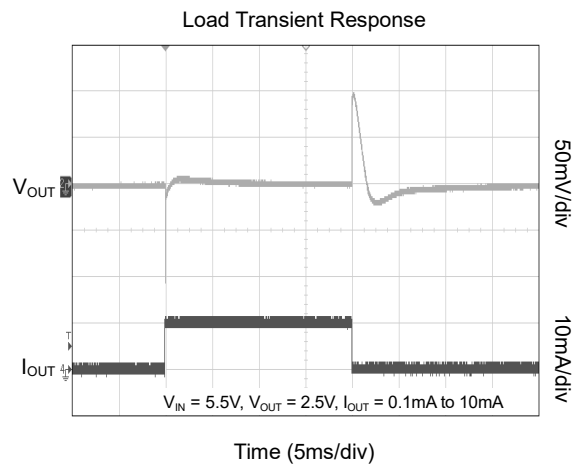
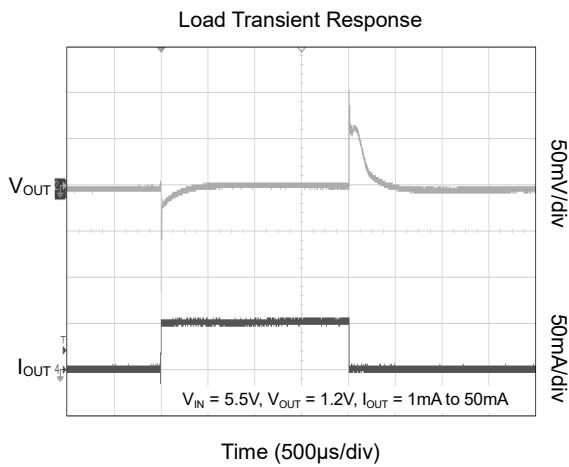
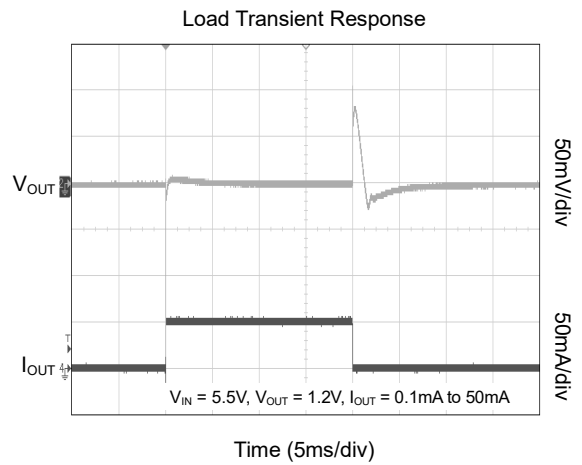
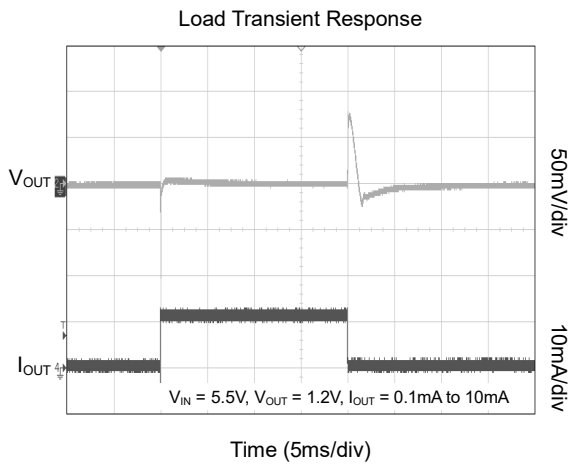
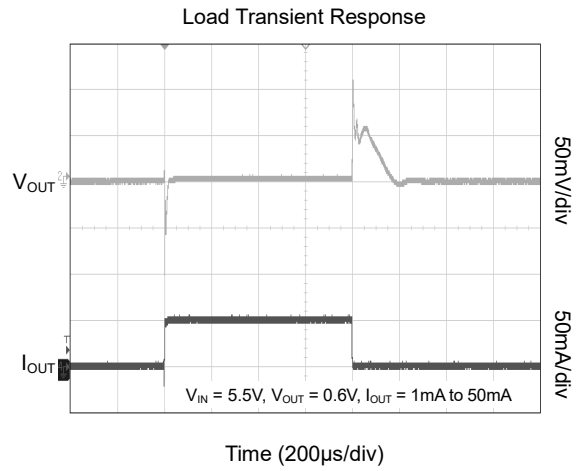
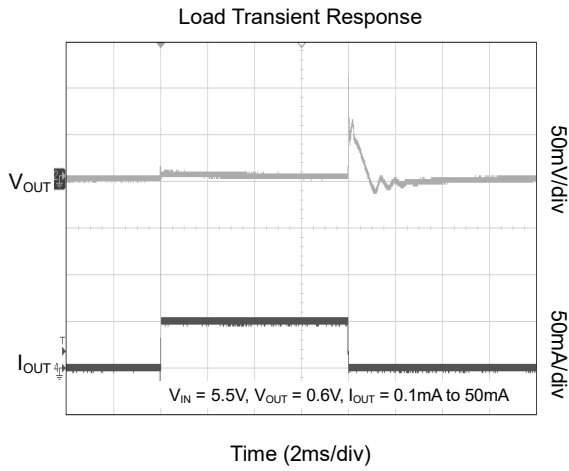

TYPICAL PERFORMANCE CHARACTERISTICS (continued)

$T_J = +25^\circ\text{C}$, $V_{IN} = V_{OUT(NOM)} + 1\text{V}$, $C_{IN} = 1\mu\text{F}$, $C_{OUT} = 1\mu\text{F}$, unless otherwise noted.

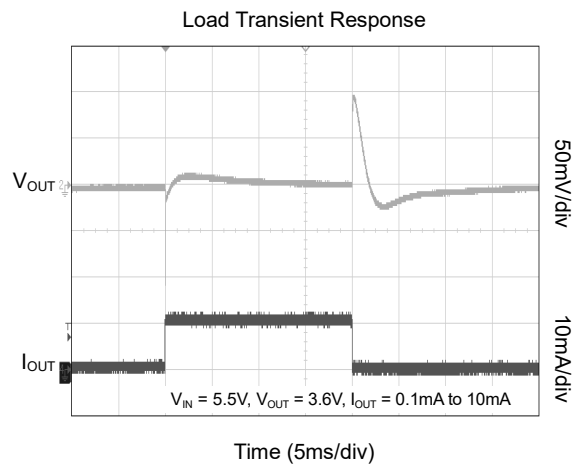
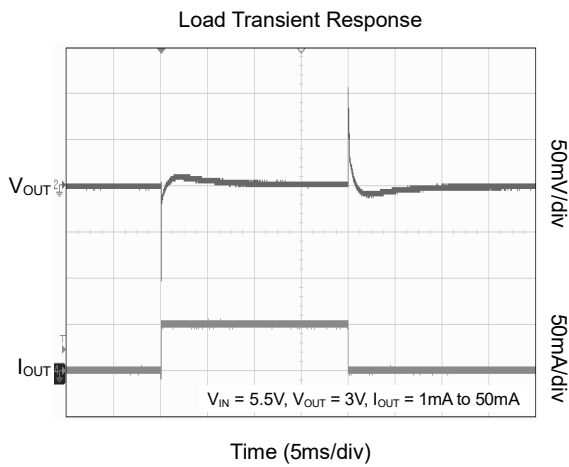
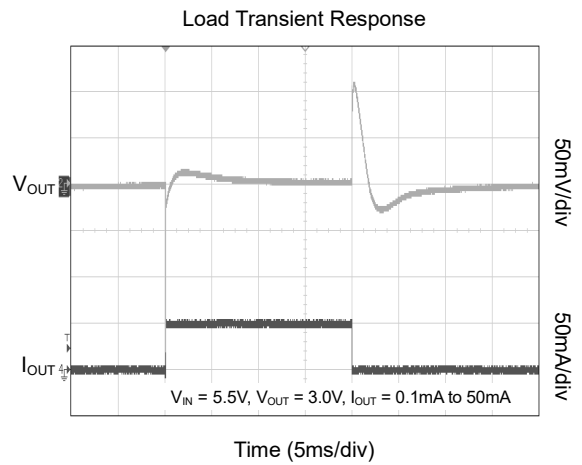
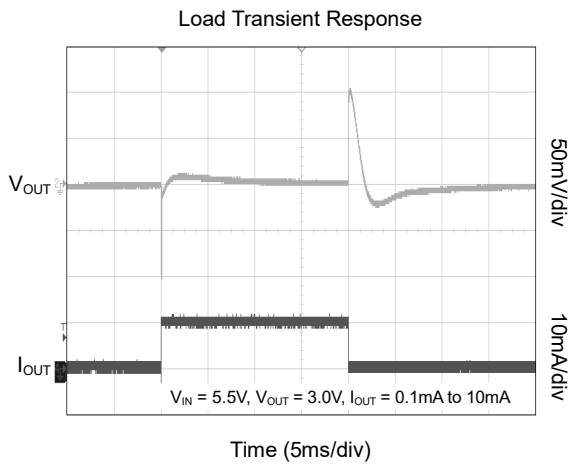
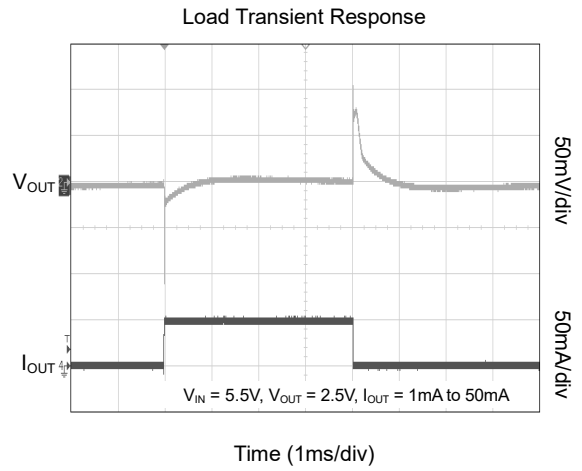
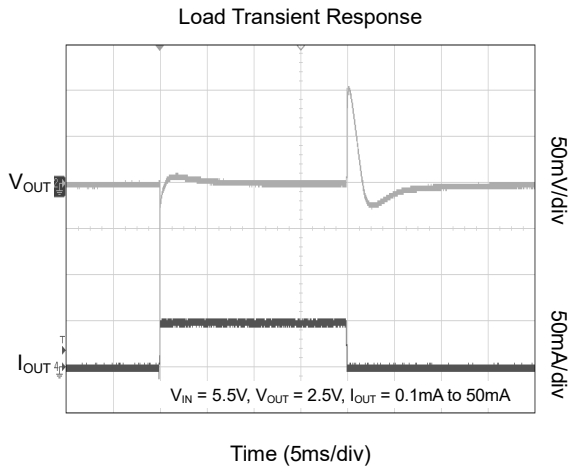

TYPICAL PERFORMANCE CHARACTERISTICS (continued)

$T_J = +25^\circ\text{C}$, $V_{IN} = V_{OUT(NOM)} + 1\text{V}$, $C_{IN} = 1\mu\text{F}$, $C_{OUT} = 1\mu\text{F}$, unless otherwise noted.

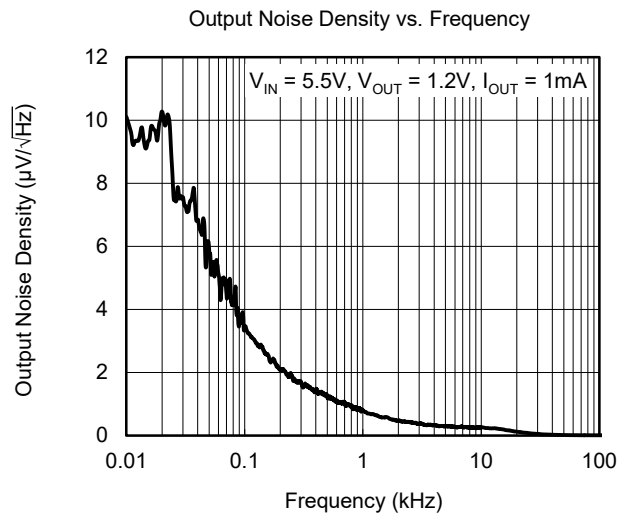
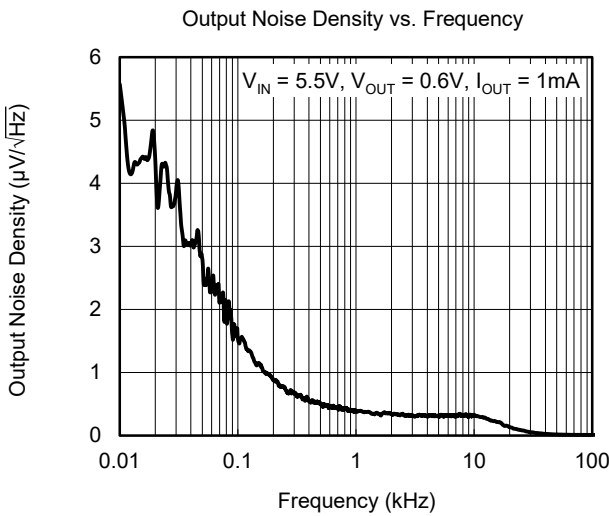
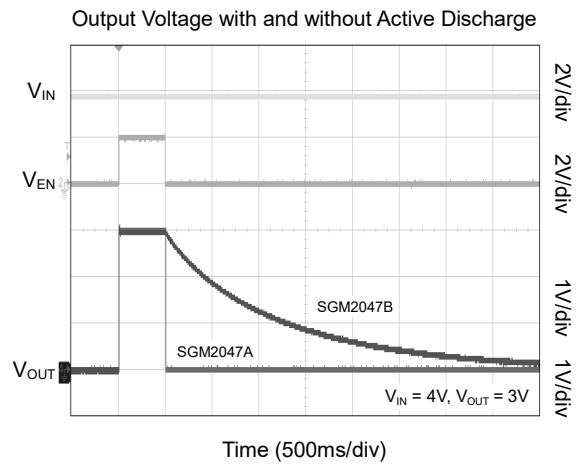
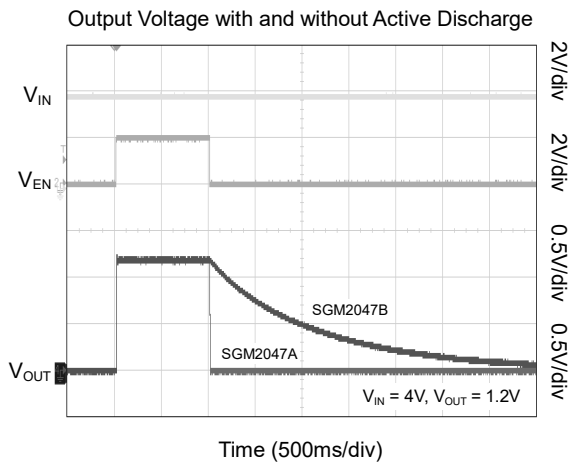
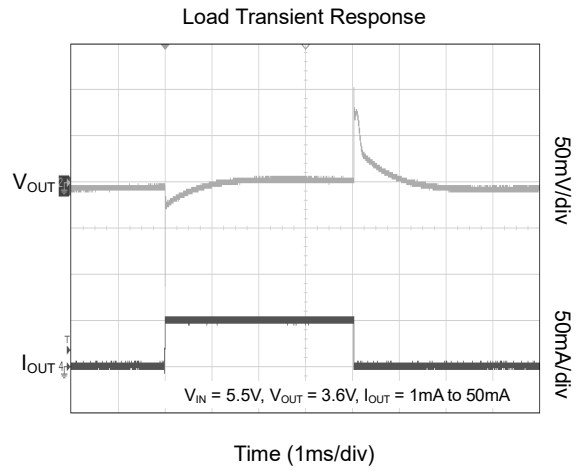
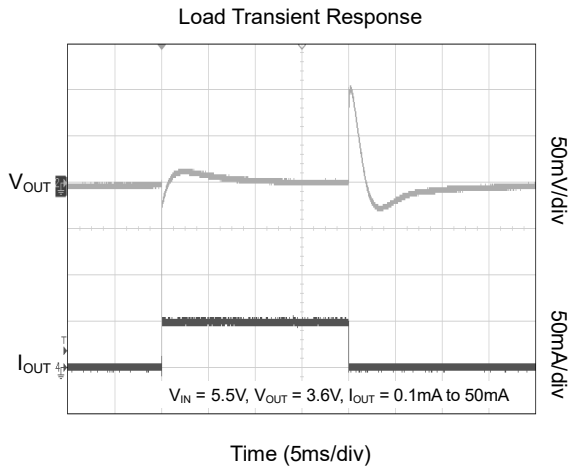

TYPICAL PERFORMANCE CHARACTERISTICS (continued)

T_J = +25°C, V_{IN} = V_{OUT(NOM)} + 1V, C_{IN} = 1μF, C_{OUT} = 1μF, unless otherwise noted.

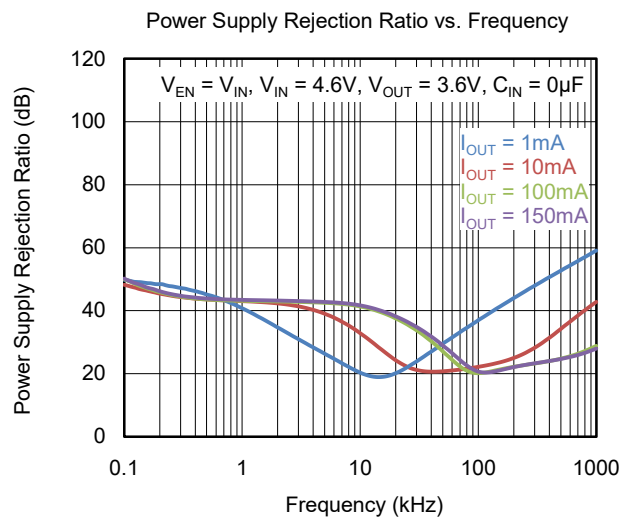
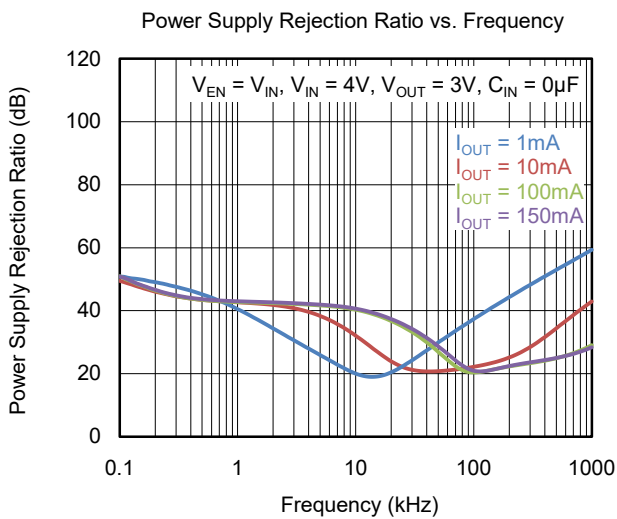
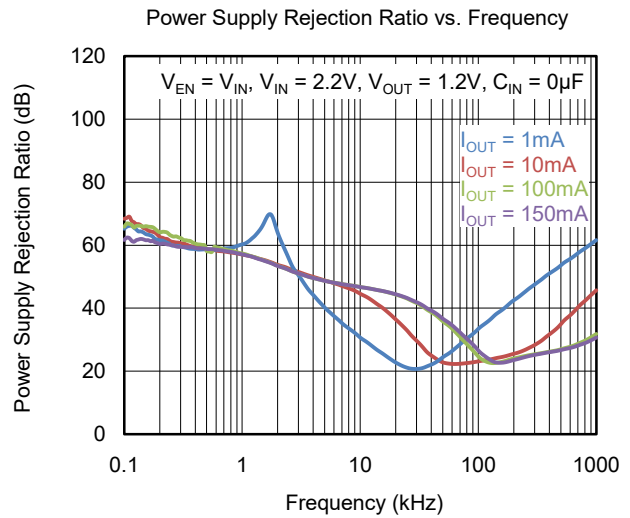
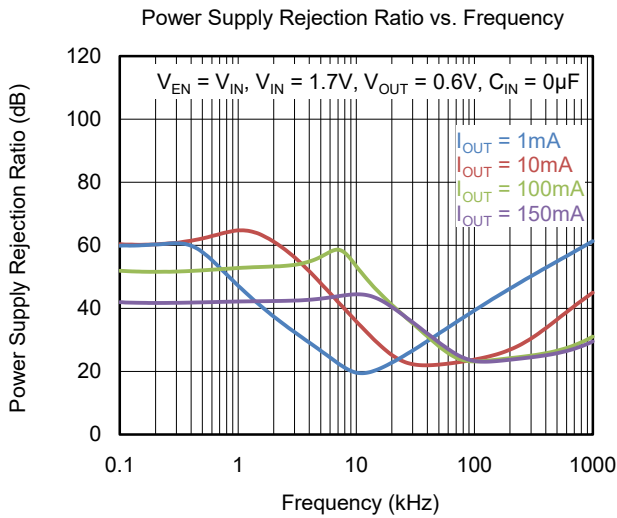
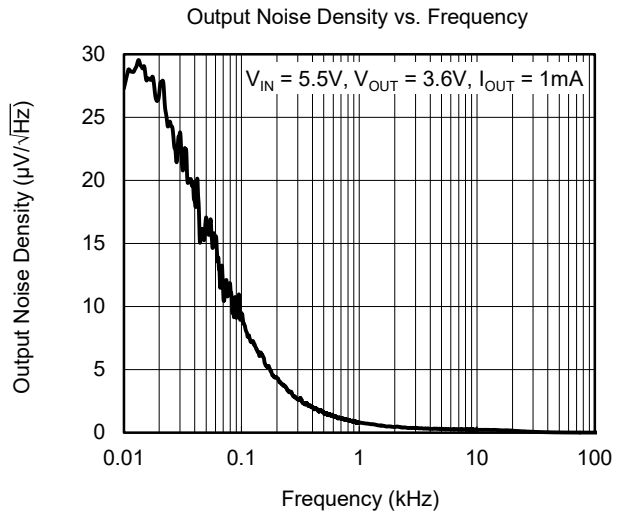
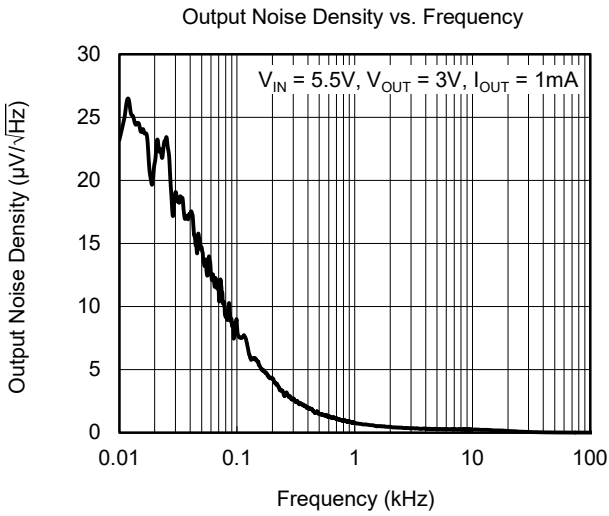

TYPICAL PERFORMANCE CHARACTERISTICS (continued)

$T_J = +25^\circ\text{C}$, $V_{IN} = V_{OUT(NOM)} + 1\text{V}$, $C_{IN} = 1\mu\text{F}$, $C_{OUT} = 1\mu\text{F}$, unless otherwise noted.

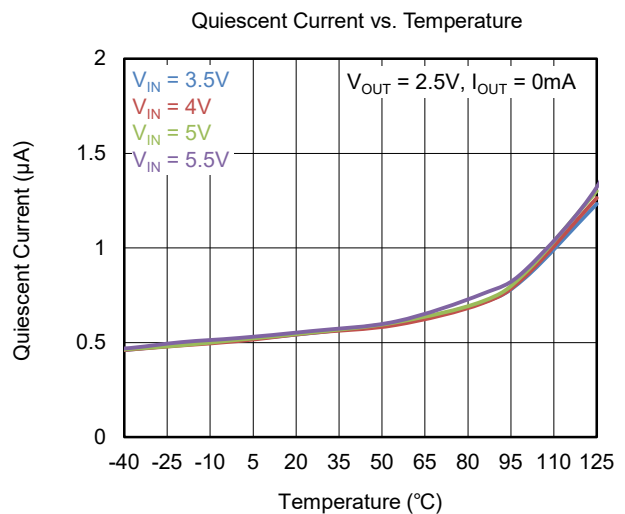
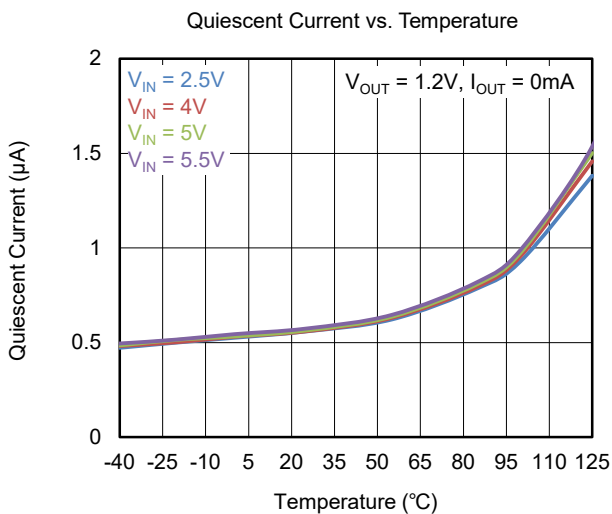
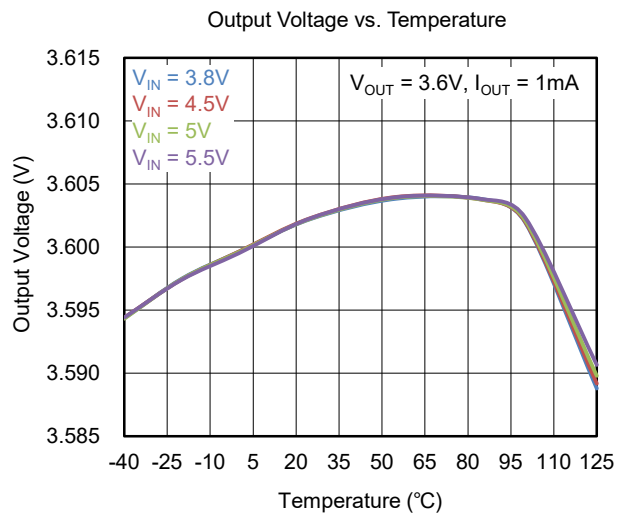
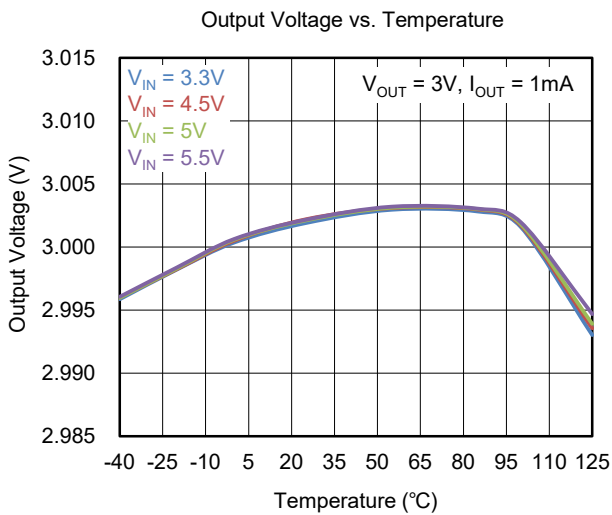
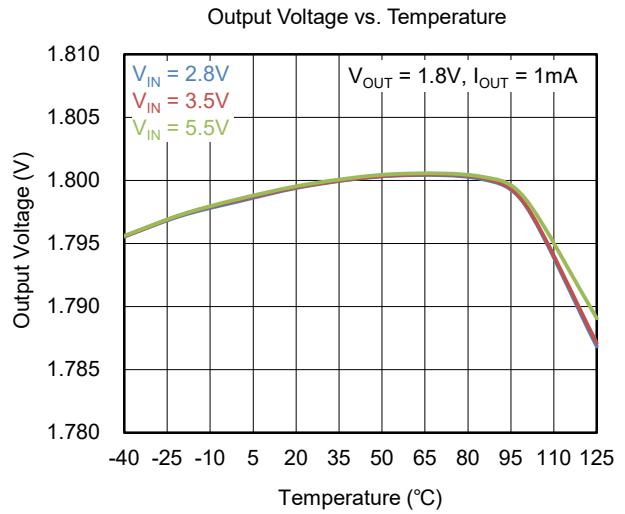
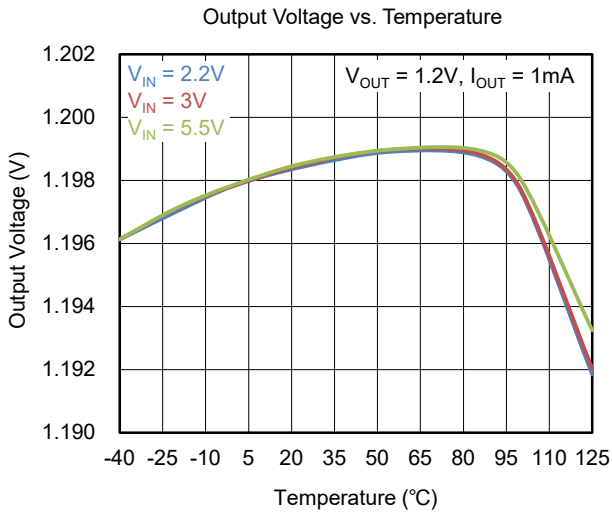

TYPICAL PERFORMANCE CHARACTERISTICS (continued)

$T_J = +25^\circ\text{C}$, $V_{IN} = V_{OUT(NOM)} + 1\text{V}$, $C_{IN} = 1\mu\text{F}$, $C_{OUT} = 1\mu\text{F}$, unless otherwise noted.

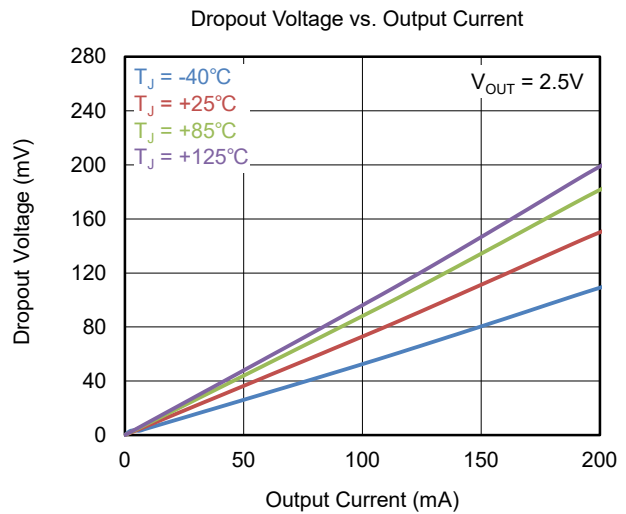
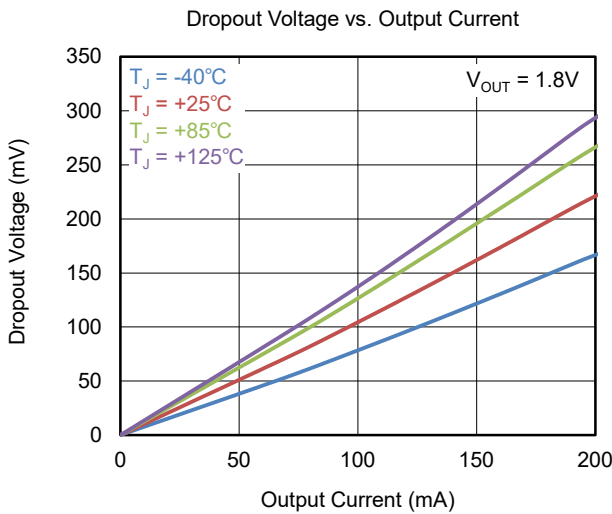
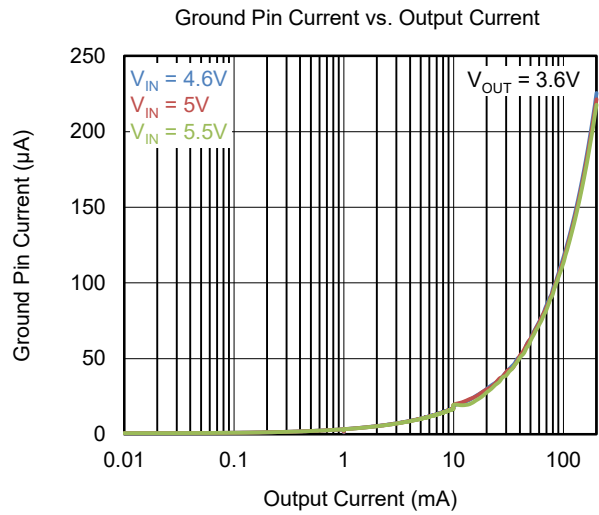
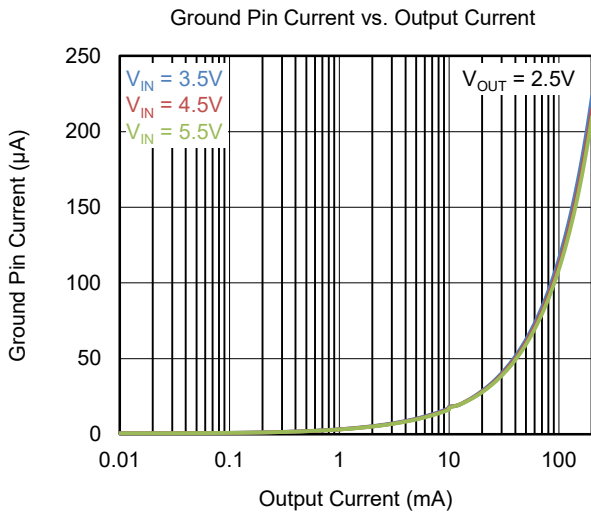
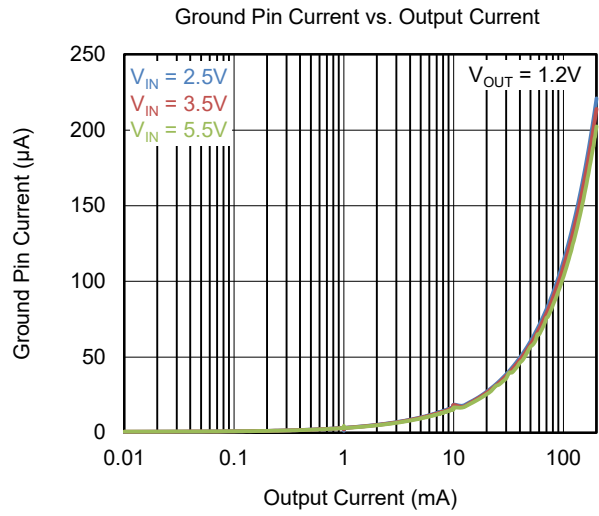
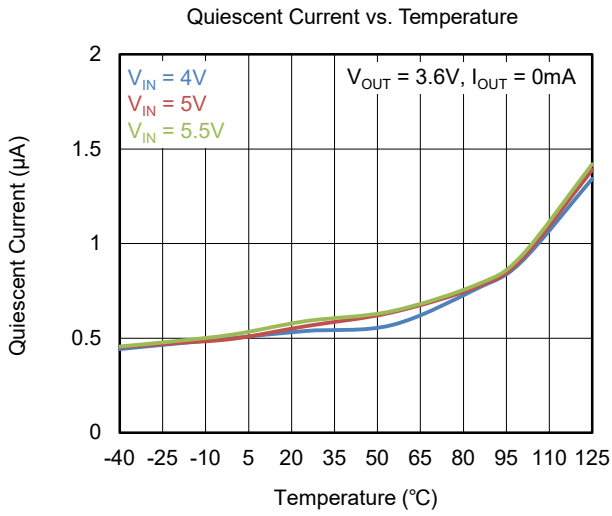

TYPICAL PERFORMANCE CHARACTERISTICS (continued)

$T_J = +25^\circ\text{C}$, $V_{IN} = V_{OUT(NOM)} + 1\text{V}$, $C_{IN} = 1\mu\text{F}$, $C_{OUT} = 1\mu\text{F}$, unless otherwise noted.

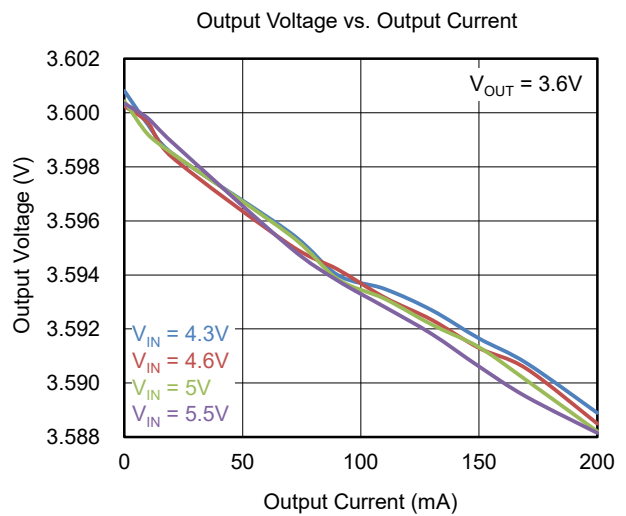
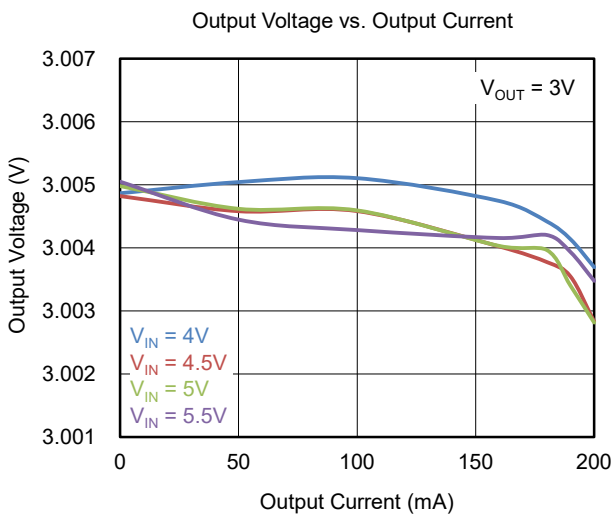
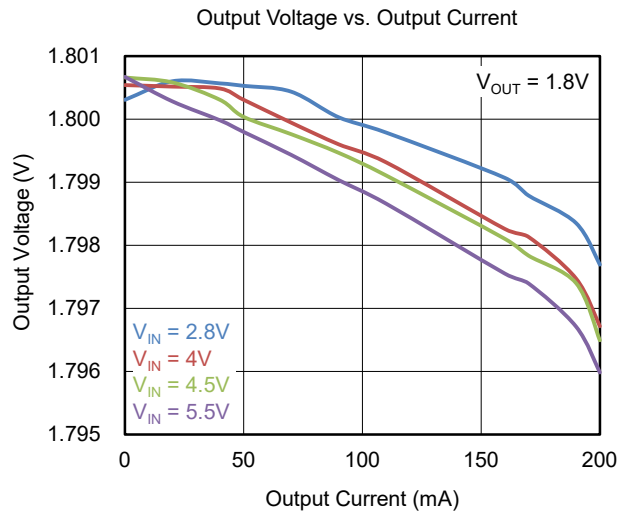
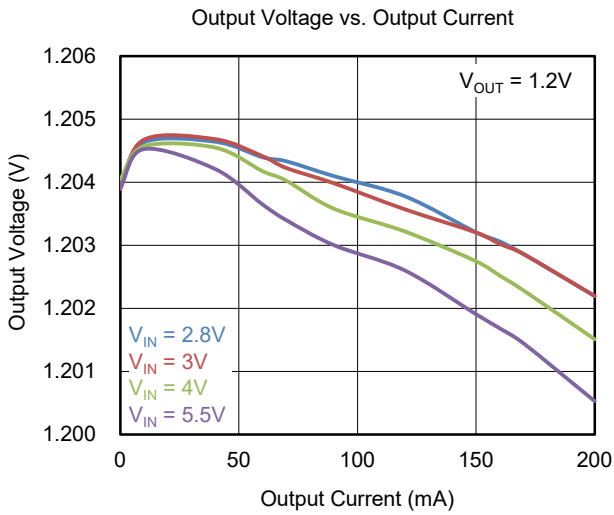
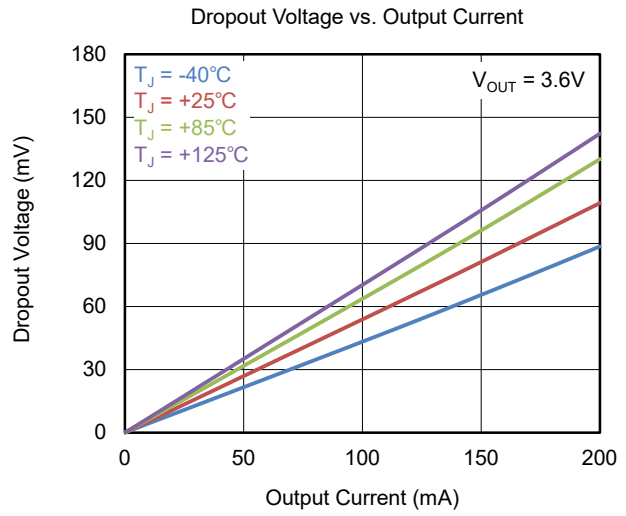
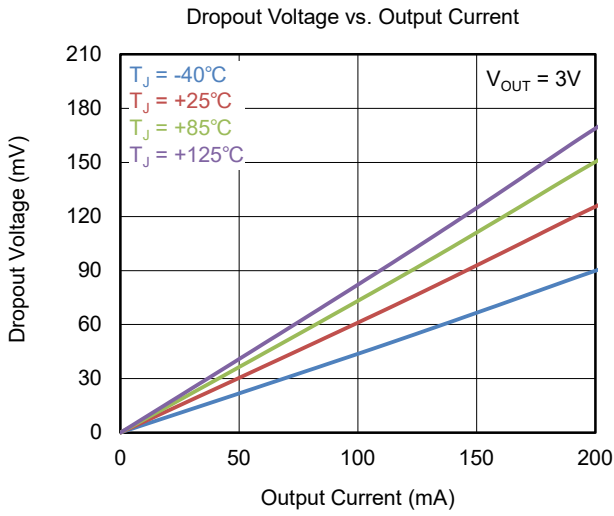

APPLICATION INFORMATION

The SGM2047 is an ultra-low quiescent current, fast transient response high performance LDO and provides 200mA output current. These features make the device a reliable solution to solve many challenging problems in the generation of clean and accurate power supply. The SGM2047 also provides the protection functions for output overload, output short-circuit condition and overheating.

The SGM2047 provides an EN pin as an external chip enable control to enable/disable the device. When the regulator is in shutdown state, the shutdown current consumes as low as 0.065 μ A (TYP).

Input Capacitor Selection (C_{IN})

The input decoupling capacitor should be placed as close as possible to the IN pin for ensuring the device stability. 1 μ F or larger X7R or X5R ceramic capacitor is selected to get good dynamic performance.

When V_{IN} is required to provide large current instantaneously, a large effective input capacitor is required. Multiple input capacitors can limit the input tracking inductance. Adding more input capacitors is available to restrict the ringing and to keep it below the device absolute maximum ratings.

Output Capacitor Selection (C_{OUT})

The output capacitor should be placed as close as possible to the OUT pin. 1 μ F or larger X7R or X5R ceramic capacitor is selected to get good dynamic

performance. For ceramic capacitor, temperature, DC bias and package size will change the effective capacitance, so enough margin of C_{OUT} must be considered in design. Additionally, C_{OUT} with larger capacitance and lower ESR will help increase the high frequency PSRR and improve the load transient response.

Enable Operation

The EN pin of the SGM2047 is used to enable/disable the device and to deactivate/activate the output automatic discharge function.

When the EN pin voltage is lower than 0.4V, the device is in shutdown state. There is no current flowing from IN to OUT pins. In this state, the automatic discharge transistor is active to discharge the output voltage through an 80 Ω (TYP) resistor.

When the EN pin voltage is higher than 1.2V, the device is in active state. The output voltage is regulated to the expected value and the automatic discharge transistor is turned off.

Thermal Shutdown

The SGM2047 can detect the temperature of die. When the die temperature exceeds the threshold value of thermal shutdown, the SGM2047 will be in shutdown state and it will remain in this state until the die temperature decreases to +130 $^{\circ}$ C.

REVISION HISTORY

NOTE: Page numbers for previous revisions may differ from page numbers in the current version.

Changes from Original (SEPTEMBER 2023) to REV.A	Page
Changed from product preview to production data.....	All

PACKAGE OUTLINE DIMENSIONS

XTDFN-1x1-4L

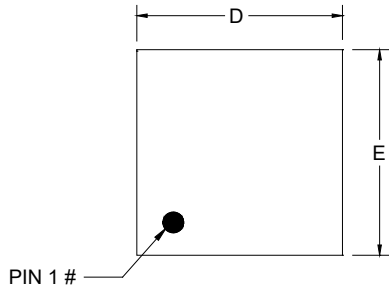

TOP VIEW

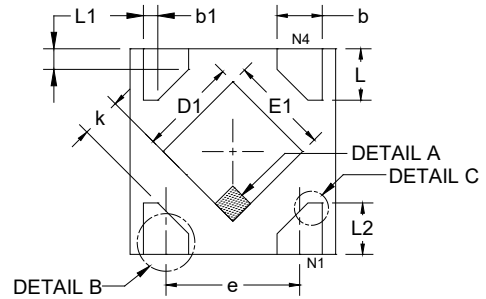

BOTTOM VIEW

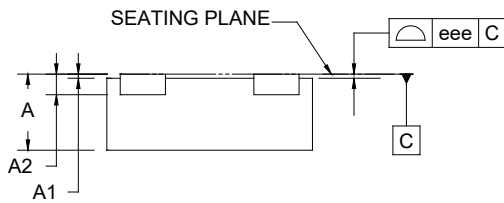

SIDE VIEW

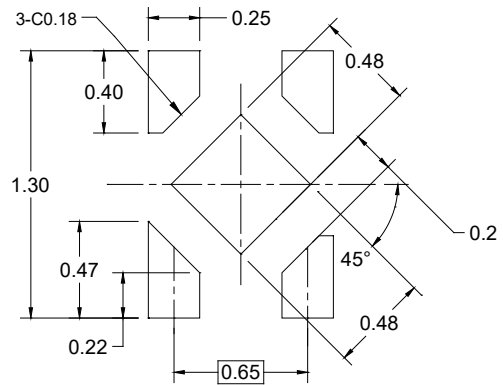

RECOMMENDED LAND PATTERN (Unit: mm)

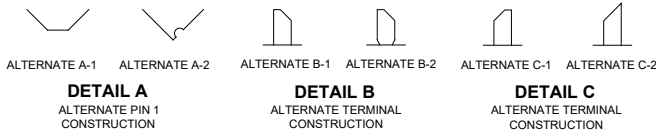

Symbol	Dimensions In Millimeters		
	MIN	MOD	MAX
A	0.340	0.370	0.400
A1	0.000	0.020	0.050
A2	0.100 REF		
b	0.170	-	0.300
b1	0.068 REF		
D	0.950	1.000	1.050
E	0.950	1.000	1.050
D1	0.430	0.480	0.530
E1	0.430	0.480	0.530
L	0.200	0.250	0.300
L1	0.093 REF		
L2	0.200	-	0.370
e	0.650 BSC		
k	0.150	-	-
eee	-	0.050	-

NOTE: This drawing is subject to change without notice.

PACKAGE INFORMATION

PACKAGE OUTLINE DIMENSIONS

SOT-23-5

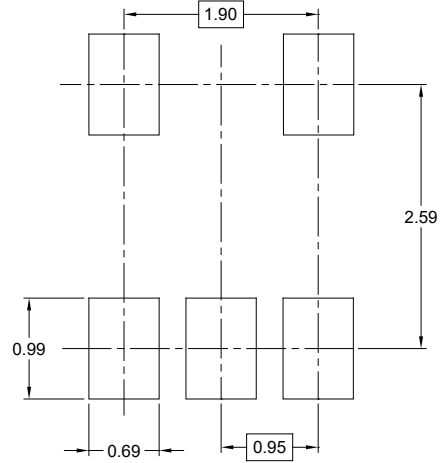
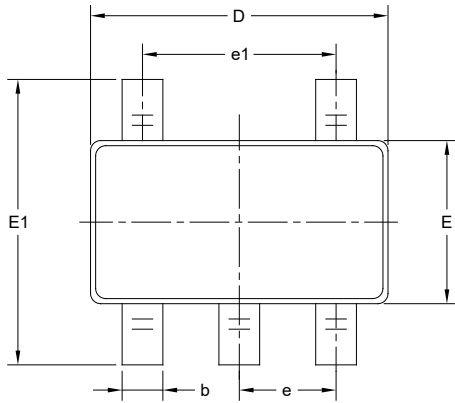

RECOMMENDED LAND PATTERN (Unit: mm)

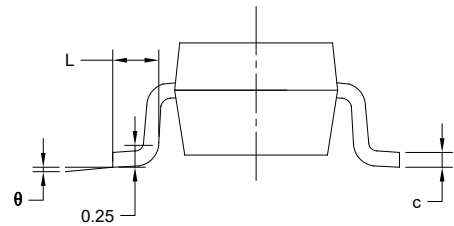
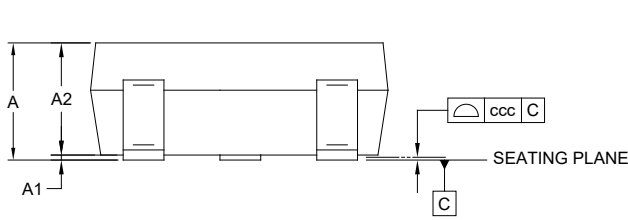

Symbol	Dimensions In Millimeters		
	MIN	MOD	MAX
A	-	-	1.450
A1	0.000	-	0.150
A2	0.900	-	1.300
b	0.300	-	0.500
c	0.080	-	0.220
D	2.750	-	3.050
E	1.450	-	1.750
E1	2.600	-	3.000
e	0.950 BSC		
e1	1.900 BSC		
L	0.300	-	0.600
θ	0°	-	8°
ccc	0.100		

NOTES:

1. This drawing is subject to change without notice.
2. The dimensions do not include mold flashes, protrusions or gate burrs.
3. Reference JEDEC MO-178.

PACKAGE INFORMATION

TAPE AND REEL INFORMATION

REEL DIMENSIONS

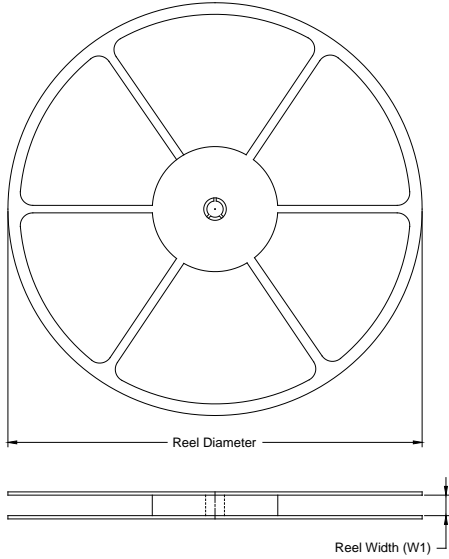

TAPE DIMENSIONS

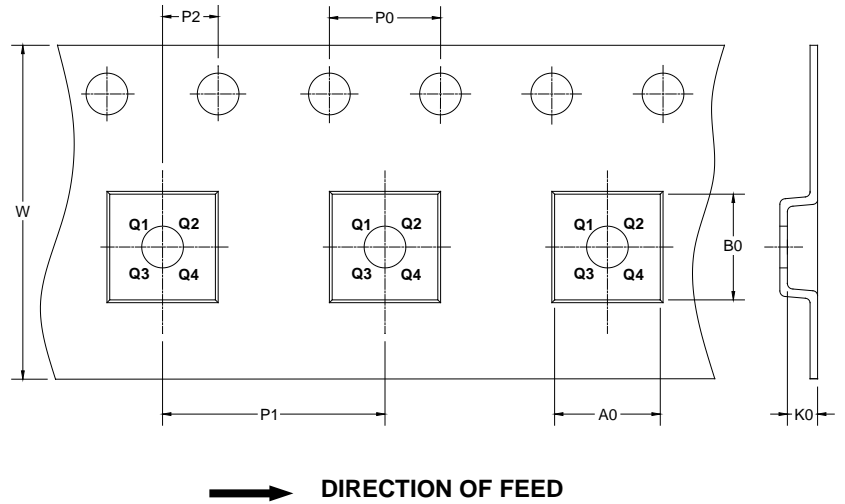

NOTE: The picture is only for reference. Please make the object as the standard.

KEY PARAMETER LIST OF TAPE AND REEL

Package Type	Reel Diameter	Reel Width W1 (mm)	A0 (mm)	B0 (mm)	K0 (mm)	P0 (mm)	P1 (mm)	P2 (mm)	W (mm)	Pin1 Quadrant
XTDFN-1x1-4L	7"	9.5	1.16	1.16	0.50	4.0	2.0	2.0	8.0	Q1
SOT-23-5	7"	9.5	3.20	3.20	1.40	4.0	4.0	2.0	8.0	Q3

DD00001

PACKAGE INFORMATION

CARTON BOX DIMENSIONS



NOTE: The picture is only for reference. Please make the object as the standard.

KEY PARAMETER LIST OF CARTON BOX

Reel Type	Length (mm)	Width (mm)	Height (mm)	Pizza/Carton
7" (Option)	368	227	224	8
7"	442	410	224	18

DD0002