

### GENERAL DESCRIPTION

The SGM42609 is a motor driver device with one integrated H-bridge that can run one DC brush motor solenoid or other inductive load. It can be used in a variety of applications such as toothbrushes and battery-powered toys.

The H-bridge consists of four N-MOSFETs to drive the motor windings. The SGM42609 can supply up to 2A peak or 1.5A RMS output current (with proper heatsinking at  $V_{CC} = 5V$  and  $T_A = +25^\circ C$ ). At lower  $V_{CC}$  voltages, the current capability is decreased slightly.

Internal protection functions are provided for over-current protection (OCP), power supply under-voltage lockout (UVLO), charge pump under-voltage lockout (CPUV) and over-temperature protection (OTP). Fault conditions are indicated by the nFAULT pin.

Sleep mode allows saving power when the device is not driving the motor. The SGM42609 will enter into sleep mode when IN1 and IN2 are low for more than  $t_{sleep}$ .

The SGM42609 is available in Green MSOP-10 and TDFN-3x3-10L packages. It operates over an ambient temperature range of  $-40^\circ C$  to  $+125^\circ C$ .

### FEATURES

- **Power Supply Voltage Range: 2.7V to 24V**
- **Single H-Bridge Motor Driver**
- **Drives One DC Brush Motor**
- **Low On-Resistance (0.48Ω for HS + LS)**
- **1.5A RMS Output Current**
- **2A Peak Current at  $V_{CC} = 5V$ ,  $T_A = +25^\circ C$**
- **Active Low Fault Indication Pin (nFAULT)**
- **Available in Green MSOP-10 and TDFN-3x3-10L Packages**

### APPLICATIONS

Cameras  
Robotics  
Toothbrushes  
Gaming Machines  
Battery-Powered Toys  
Office Automation Machines

**PACKAGE/ORDERING INFORMATION**

MODEL	PACKAGE DESCRIPTION	SPECIFIED TEMPERATURE RANGE	ORDERING NUMBER	PACKAGE MARKING	PACKING OPTION
SGM42609	MSOP-10	-40°C to +125°C	SGM42609XMS10G/TR	SGM42609 XMS10 XXXXX	Tape and Reel, 4000
	TDFN-3×3-10L	-40°C to +125°C	SGM42609XTD10G/TR	SGM 42609D XXXXX	Tape and Reel, 4000

NOTE: XXXXX = Date Code and Vendor Code.

Green (RoHS & HSF): SG Micro Corp defines "Green" to mean Pb-Free (RoHS compatible) and free of halogen substances. If you have additional comments or questions, please contact your SGMICRO representative directly.

**ABSOLUTE MAXIMUM RATINGS**

Power Supply Voltage Range, V<sub>CC</sub> ..... -0.3V to 26.5V  
 Digital Input Pin Voltage Range ..... -0.3V to 6V  
 ISEN Pin Voltage Range..... -0.3V to 0.5V  
 Peak Motor Drive Output Current ..... Internally Limited  
 Package Thermal Resistance  
 MSOP-10, θ<sub>JA</sub> ..... 175°C/W  
 TDFN-3×3-10L, θ<sub>JA</sub> ..... 80°C/W  
 Junction Temperature ..... +150°C  
 Storage Temperature Range ..... -65°C to +150°C  
 Lead Temperature (Soldering, 10sec) ..... +260°C  
 ESD Susceptibility  
 HBM ..... 5000V  
 MM ..... 300V  
 CDM ..... 1000V

**RECOMMENDED OPERATING CONDITIONS**

Power Supply Voltage Range, V<sub>CC</sub> ..... 2.7V to 24V  
 Digital Input Pin Voltage Range ..... 0V to 5.5V  
 Continuous DC/RMS Output Current ..... 1.5A  
 Operating Temperature Range ..... -40°C to +125°C

**OVERSTRESS CAUTION**

Stresses beyond those listed in Absolute Maximum Ratings may cause permanent damage to the device. Exposure to absolute maximum rating conditions for extended periods may affect reliability. Functional operation of the device at any conditions beyond those indicated in the Recommended Operating Conditions section is not implied.

**ESD SENSITIVITY CAUTION**

This integrated circuit can be damaged if ESD protections are not considered carefully. SGMICRO recommends that all integrated circuits be handled with appropriate precautions. Failure to observe proper handling and installation procedures can cause damage. ESD damage can range from subtle performance degradation to complete device failure. Precision integrated circuits may be more susceptible to damage because even small parametric changes could cause the device not to meet the published specifications.

**DISCLAIMER**

SG Micro Corp reserves the right to make any change in circuit design, or specifications without prior notice.

PIN CONFIGURATIONS

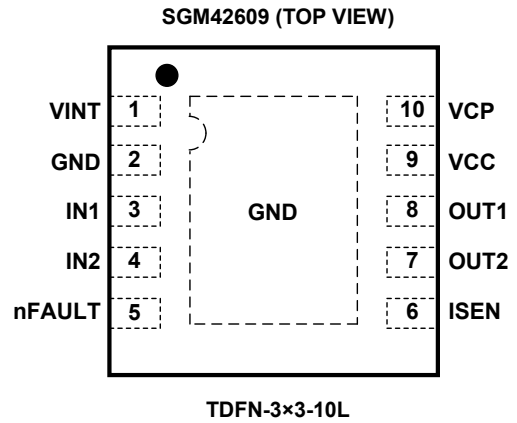
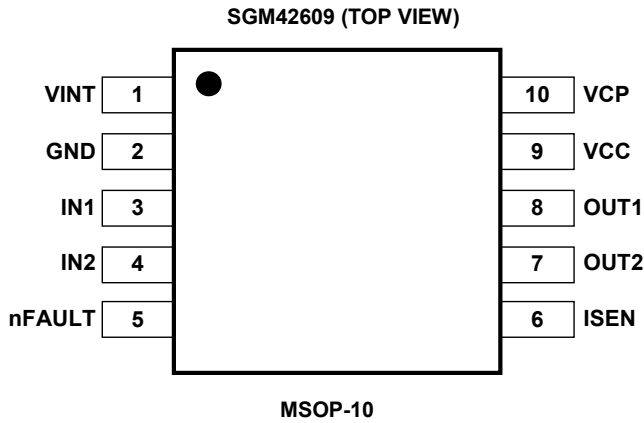

PIN DESCRIPTION

PIN		NAME	I/O	FUNCTION
MSOP-10	TDFN-3x3-10L			
1	1	VINT	-	Internal Supply Bypass. Bypass to GND with a 2.2µF, 6.3V capacitor.
2	2	GND	G	Ground.
3	3	IN1	I	Bridge Input 1. Internal pull-down.
4	4	IN2	I	Bridge Input 2. Internal pull-down.
5	5	nFAULT	OD	Active-Low Fault Flag. Go low when a fault occurs (over-current, power supply under-voltage, charge pump under-voltage, over-temperature).
6	6	ISEN	IO	Bridge I <sub>SENSE</sub> (GND). Connect through a current sense resistor to GND for bridge.
7	7	OUT2	O	Bridge Output 2.
8	8	OUT1	O	Bridge Output 1.
9	9	VCC	P	Power Supply Pin. Connect this pin to the motor supply and bypass with a 10µF (MIN) ceramic capacitor to GND.
10	10	VCP	IO	Charge Pump Output. Connect a 0.01µF, 30V (MIN) ceramic capacitor to VCC pin.
—	Exposed Pad	GND	G	GND.

NOTE: I = input; O = output; IO = input or output; OD = open-drain output; G: ground; P: power for the circuit.

## ELECTRICAL CHARACTERISTICS

(V<sub>CC</sub> = 5V, Full = -40°C to +125°C. Typical values are at T<sub>A</sub> = +25°C, unless otherwise noted.)

PARAMETER	SYMBOL	CONDITIONS	TEMP	MIN	TYP	MAX	UNITS
<b>Power Supplies</b>							
VCC Operating Supply Voltage	V <sub>CC</sub>		Full	2.7		24	V
VCC Operating Supply Current	I <sub>VCC</sub>	IN1 = 0V, IN2 = 0V (less than t <sub>sleep</sub> )	+25°C		1.5	2	mA
VCC Sleep Mode Supply Current	I <sub>VCCQ</sub>	IN1 = 0V, IN2 = 0V (more than t <sub>sleep</sub> )	+25°C		0.9	2.5	μA
Enter Sleep Mode Time	t <sub>sleep</sub>	IN1 = 0V, IN2 = 0V	+25°C	5.2	6.2	7.4	s
VCC Under-Voltage Lockout Voltage	V <sub>UVLO</sub>		+25°C		2.3	2.4	V
VCC Under-Voltage Lockout Voltage Hysteresis	V <sub>HYS</sub>		+25°C		100		mV
<b>Logic Level Inputs</b>							
Input Low Voltage	V <sub>IL</sub>	V <sub>CC</sub> = 2.7V to 24V	Full			0.7	V
Input High Voltage	V <sub>IH</sub>	V <sub>CC</sub> = 2.7V to 24V	Full	2.3			V
Input Hysteresis	V <sub>HYS</sub>		+25°C		200		mV
Input Pull-Down Resistance	R <sub>PD</sub>		+25°C		160		kΩ
Input Low Current	I <sub>IL</sub>	V <sub>IN</sub> = 0V	Full	-1		1	μA
Input High Current	I <sub>IH</sub>	V <sub>IN</sub> = 5V	Full		35	48	μA
Input Deglitch Time	t <sub>DEG</sub>	V <sub>IN</sub> = 5V	+25°C		460		ns
<b>nFAULT Output (Open-Drain Output)</b>							
Output Low Voltage	V <sub>OL</sub>	V <sub>IN</sub> = 2V, I <sub>O</sub> = -5mA	+25°C			0.52	V
Output High-Impedance Leakage Current	I <sub>OH</sub>		+25°C			1	μA
<b>H-Bridge FETs</b>							
HS FET On-Resistance	R <sub>DS(ON)</sub>	V <sub>CC</sub> = 5V, I <sub>O</sub> = 200mA	+25°C		260		mΩ
		V <sub>CC</sub> = 5V, I <sub>O</sub> = 200mA	Full			545	
		V <sub>CC</sub> = 2.7V, I <sub>O</sub> = 200mA	+25°C		320		
		V <sub>CC</sub> = 2.7V, I <sub>O</sub> = 200mA	Full			635	
LS FET On-Resistance	R <sub>DS(ON)</sub>	V <sub>CC</sub> = 5V, I <sub>O</sub> = -200mA	+25°C		220		mΩ
		V <sub>CC</sub> = 5V, I <sub>O</sub> = -200mA	Full			510	
		V <sub>CC</sub> = 2.7V, I <sub>O</sub> = -200mA	+25°C		260		
		V <sub>CC</sub> = 2.7V, I <sub>O</sub> = -200mA	Full			590	
Off-State Leakage Current	I <sub>OFF</sub>	V <sub>CC</sub> = 26.5V, V <sub>OUT</sub> = 0V	+25°C	-1.5		1.5	μA
<b>Motor Driver</b>							
Current Control PWM Frequency	f <sub>PWM</sub>	Internal PWM Frequency	+25°C		45		kHz
Rise Time	t <sub>R</sub>	R <sub>L</sub> = 16Ω to GND, 10% to 90% V <sub>CC</sub>	+25°C		130		ns
Fall Time	t <sub>F</sub>	R <sub>L</sub> = 16Ω to V <sub>CC</sub> , 90% to 10% V <sub>CC</sub>	+25°C		120		ns
Propagation Delay INx to OUTx	t <sub>PROP</sub>		+25°C		1.2		μs
Dead Time <sup>(1)</sup>	t <sub>DEAD</sub>		+25°C		550		ns

**ELECTRICAL CHARACTERISTICS**

(V<sub>CC</sub> = 5V, Full = -40°C to +125°C. Typical values are at T<sub>A</sub> = +25°C, unless otherwise noted.)

PARAMETER	SYMBOL	CONDITIONS	TEMP	MIN	TYP	MAX	UNITS
<b>Protection Circuits</b>							
Over-Current Protection Trip Level	I <sub>OC</sub> P		+25°C	2.5	3.3		A
OCP Deglitch Time	t <sub>DEG</sub>		+25°C		4		µs
Over-Current Protection Period	t <sub>OC</sub> P		+25°C		1.4		ms
Thermal Shutdown Temperature	T <sub>TSD</sub>	Die Temperature			160		°C
Thermal Shutdown Temperature Hysteresis	T <sub>HYS</sub>				30		°C
<b>Current Control</b>							
ISEN Trip Voltage	V <sub>TRIP</sub>		+25°C	150	200	260	mV
Current Sense Blanking Time	t <sub>BLANK</sub>		+25°C		4		µs
<b>nSLEEP Mode</b>							
Start-Up Time	t <sub>WAKE</sub>	nSleep inactive high to H-bridge on	+25°C			1.4	ms

NOTE: 1. Internal dead time. External implementation is not necessary.

**REVISION HISTORY**

NOTE: Page numbers for previous revisions may differ from page numbers in the current version.

**Changes from Original (JUNE 2017) to REV.A**

Changed from product preview to production data..... All

PACKAGE OUTLINE DIMENSIONS

TDFN-3x3-10L

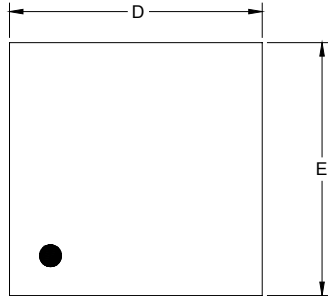

TOP VIEW

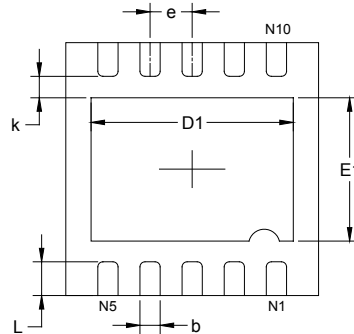

BOTTOM VIEW

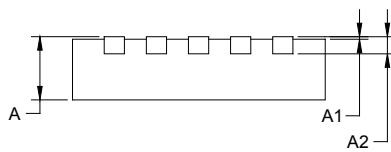

SIDE VIEW

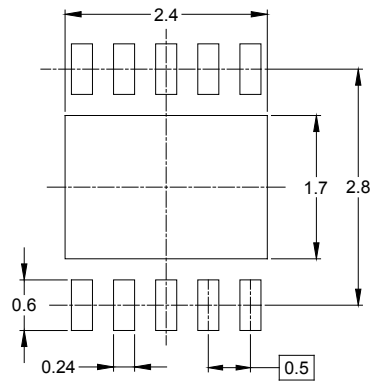

RECOMMENDED LAND PATTERN (Unit: mm)

Symbol	Dimensions In Millimeters		Dimensions In Inches	
	MIN	MAX	MIN	MAX
A	0.700	0.800	0.028	0.031
A1	0.000	0.050	0.000	0.002
A2	0.203 REF		0.008 REF	
D	2.900	3.100	0.114	0.122
D1	2.300	2.600	0.091	0.103
E	2.900	3.100	0.114	0.122
E1	1.500	1.800	0.059	0.071
k	0.200 MIN		0.008 MIN	
b	0.180	0.300	0.007	0.012
e	0.500 TYP		0.020 TYP	
L	0.300	0.500	0.012	0.020

PACKAGE OUTLINE DIMENSIONS

MSOP-10

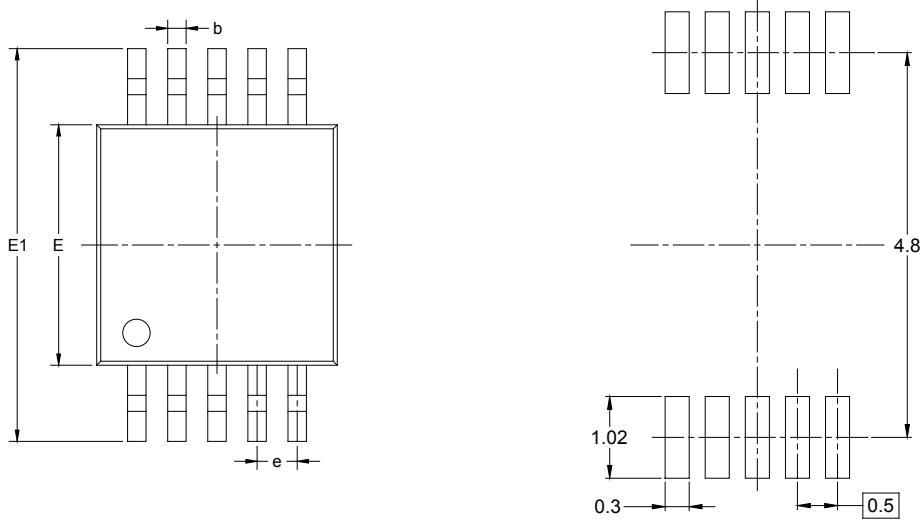

RECOMMENDED LAND PATTERN (Unit: mm)

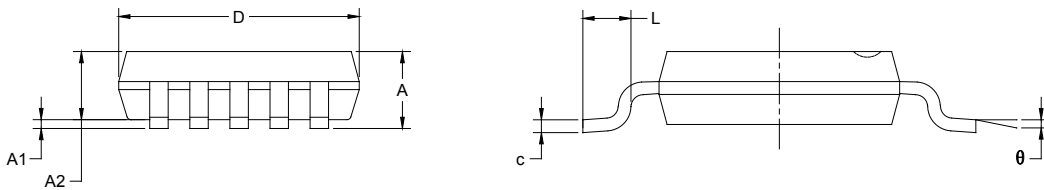

Symbol	Dimensions In Millimeters		Dimensions In Inches	
	MIN	MAX	MIN	MAX
A	0.820	1.100	0.032	0.043
A1	0.020	0.150	0.001	0.006
A2	0.750	0.950	0.030	0.037
b	0.180	0.280	0.007	0.011
c	0.090	0.230	0.004	0.009
D	2.900	3.100	0.114	0.122
E	2.900	3.100	0.114	0.122
E1	4.750	5.050	0.187	0.199
e	0.500 BSC		0.020 BSC	
L	0.400	0.800	0.016	0.031
θ	0°	6°	0°	6°

## TAPE AND REEL INFORMATION

### REEL DIMENSIONS

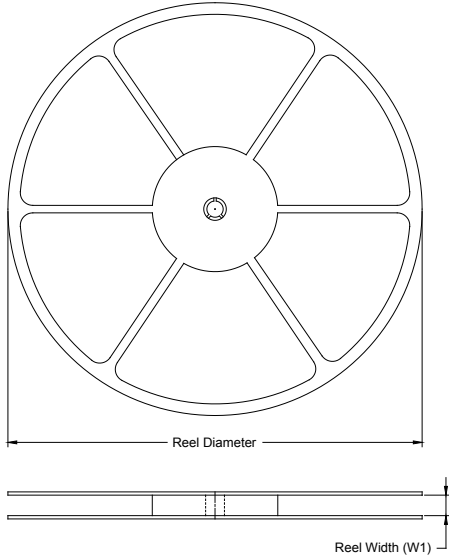

### TAPE DIMENSIONS

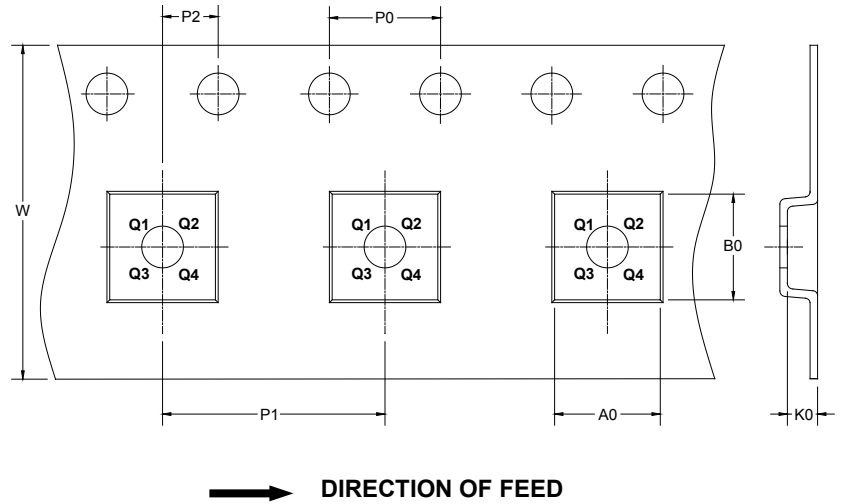

NOTE: The picture is only for reference. Please make the object as the standard.

### KEY PARAMETER LIST OF TAPE AND REEL

Package Type	Reel Diameter	Reel Width W1 (mm)	A0 (mm)	B0 (mm)	K0 (mm)	P0 (mm)	P1 (mm)	P2 (mm)	W (mm)	Pin1 Quadrant
MSOP-10	13"	12.4	5.20	3.30	1.20	4.0	8.0	2.0	12.0	Q1
TDFN-3×3-10L	13"	12.4	3.35	3.35	1.13	4.0	8.0	2.0	12.0	Q1

DD0001



# PACKAGE INFORMATION

## CARTON BOX DIMENSIONS



NOTE: The picture is only for reference. Please make the object as the standard.

## KEY PARAMETER LIST OF CARTON BOX

Reel Type	Length (mm)	Width (mm)	Height (mm)	Pizza/Carton
13"	386	280	370	5

DD0002