



# SGM8276-1/SGM8276-2/SGM8276-4

## Low Noise, High Precision, High Voltage, Rail-to-Rail I/O Operational Amplifiers

---

### GENERAL DESCRIPTION

The SGM8276-1 (single), SGM8276-2 (dual) and SGM8276-4 (quad) are low noise, high precision, high voltage operational amplifiers, which can operate from 3.3V to 36V single supply or from  $\pm 1.65V$  to  $\pm 18V$  dual power supplies. They provide rail-to-rail input with a wide input common mode voltage range and rail-to-rail output voltage swing.

The SGM8276-1/2/4 provide high slew rate, low noise, low offset, drift and bias current.

The SGM8276-1 is available in a Green SOT-23-5 package. The SGM8276-2 is available in a Green SOIC-8 package. The SGM8276-4 is available in a Green SOIC-14 package. They are specified over the extended  $-40^{\circ}C$  to  $+125^{\circ}C$  temperature range.

### FEATURES

- Rail-to-Rail Input and Output
- Wide Input Common Mode and Differential Voltage Ranges
- Low Offset Voltage: 0.3mV (TYP), 1.5mV (MAX)
- Low Input Bias Current
- Low Input Offset Current
- Output Short-Circuit Protection
- High Input Impedance
- Low Noise:  $10nV/\sqrt{Hz}$  at 1kHz
- Gain-Bandwidth Product: 10MHz
- High Slew Rate:  $8V/\mu s$
- $-40^{\circ}C$  to  $+125^{\circ}C$  Operating Temperature Range
- Small Packaging:
  - SGM8276-1 Available in a Green SOT-23-5 Package
  - SGM8276-2 Available in a Green SOIC-8 Package
  - SGM8276-4 Available in a Green SOIC-14 Package

### APPLICATIONS

High Impedance Sensors  
Photodiode Amplifiers  
High End, Professional Audio  
DAC Output Amplifiers  
Medicals

**PACKAGE/ORDERING INFORMATION**

MODEL	PACKAGE DESCRIPTION	SPECIFIED TEMPERATURE RANGE	ORDERING NUMBER	PACKAGE MARKING	PACKING OPTION
SGM8276-1	SOT-23-5	-40°C to +125°C	SGM8276-1AXN5G/TR	GMAXX	Tape and Reel, 3000
	SOT-23-5	-40°C to +125°C	SGM8276-1BXN5G/TR	GMBXX	Tape and Reel, 3000
SGM8276-2	SOIC-8	-40°C to +125°C	SGM8276-2XS8G/TR	SGM 82762XS8 XXXXX	Tape and Reel, 4000
SGM8276-4	SOIC-14	-40°C to +125°C	SGM8276-4XS14G/TR	SGM82764XS14 XXXXX	Tape and Reel, 2500

**MARKING INFORMATION**

NOTE: XX = Date Code. XXXXX = Date Code and Vendor Code.

**SOT-23-5**

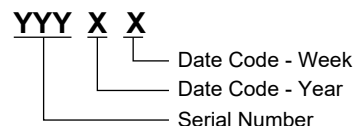

**SOIC-8/SOIC-14**

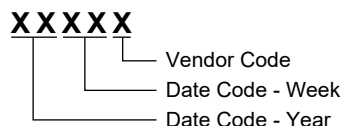

Green (RoHS & HSF): SG Micro Corp defines "Green" to mean Pb-Free (RoHS compatible) and free of halogen substances. If you have additional comments or questions, please contact your SGMICRO representative directly.

**ABSOLUTE MAXIMUM RATINGS**

Supply Voltage, +V <sub>S</sub> to -V <sub>S</sub> .....	40V
Differential Input Voltage,  V <sub>ID</sub>   .....	(+V <sub>S</sub> ) - (-V <sub>S</sub> )
Input/Output Voltage Range.....	(-V <sub>S</sub> ) - 0.3V to (+V <sub>S</sub> ) + 0.3V
Junction Temperature .....	+150°C
Storage Temperature Range.....	-65°C to +150°C
Lead Temperature (Soldering, 10s) .....	+260°C
<b>ESD Susceptibility</b>	
HBM (SGM8276-1) .....	5000V
HBM (SGM8276-2/4) .....	6000V
MM (SGM8276-1) .....	200V
MM (SGM8276-2/4) .....	300V
CDM .....	1000V

**RECOMMENDED OPERATING CONDITIONS**

Operating Temperature Range.....	-40°C to +125°C
----------------------------------	-----------------

NOTE: 1. It is recommended that CMOS device adopts the proper power supply sequence. Always sort the V<sub>S</sub> first, followed by the inputs and outputs.

**OVERSTRESS CAUTION**

Stresses beyond those listed in Absolute Maximum Ratings may cause permanent damage to the device. Exposure to absolute maximum rating conditions for extended periods may affect reliability. Functional operation of the device at any conditions beyond those indicated in the Recommended Operating Conditions section is not implied.

**ESD SENSITIVITY CAUTION**

This integrated circuit can be damaged if ESD protections are not considered carefully. SGMICRO recommends that all integrated circuits be handled with appropriate precautions. Failure to observe proper handling and installation procedures can cause damage. ESD damage can range from subtle performance degradation to complete device failure. Precision integrated circuits may be more susceptible to damage because even small parametric changes could cause the device not to meet the published specifications.

**DISCLAIMER**

SG Micro Corp reserves the right to make any change in circuit design, or specifications without prior notice.

**PIN CONFIGURATIONS**

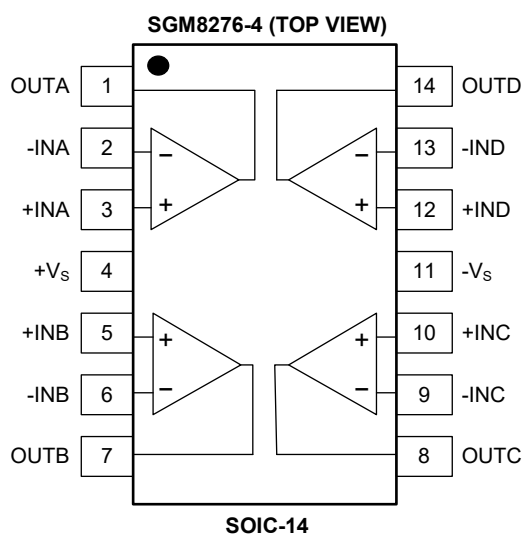
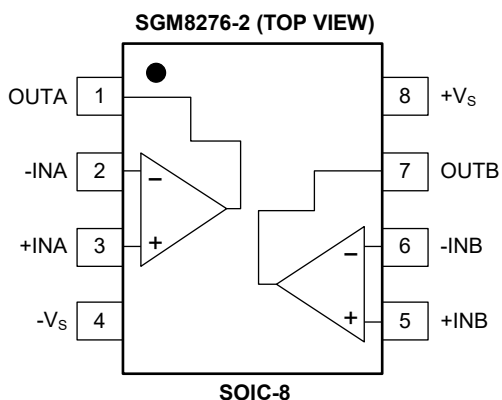
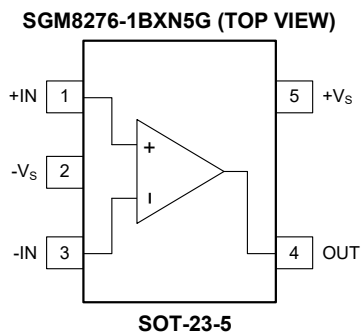
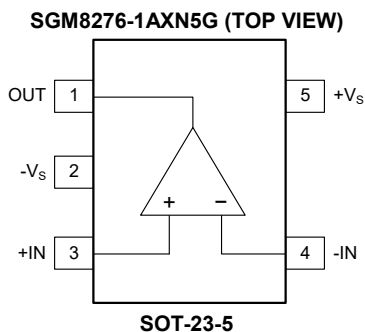

**ELECTRICAL CHARACTERISTICS**

( $V_S = \pm 1.65V$  to  $\pm 18V$  and  $R_L = 2k\Omega$  connected to  $0V$ , Full =  $-40^\circ C$  to  $+125^\circ C$ , typical values are at  $T_A = +25^\circ C$ , unless otherwise noted.)

PARAMETER	SYMBOL	CONDITIONS	TEMP	MIN	TYP	MAX	UNITS
<b>Input Characteristics</b>							
Input Offset Voltage	$V_{OS}$	$V_S = \pm 2.5V$ to $\pm 18V$ , $V_{CM} = 0V$	+25°C		0.3	1.5	mV
			Full			1.8	
Input Offset Voltage Drift	$\Delta V_{OS}/\Delta T$		Full		1		$\mu V/^\circ C$
Input Bias Current	$I_B$	$V_{CM} = 0V$	+25°C		$\pm 50$	$\pm 300$	pA
Input Offset Current	$I_{OS}$	$V_{CM} = 0V$	+25°C		$\pm 10$	$\pm 300$	pA
Maximum Differential Input Bias Current	$ I_{ID} $	$V_S = \pm 18V$ , $V_{ID} = \pm 18V$	+25°C		2	3	$\mu A$
			Full			4	
Input Common Mode Voltage Range	$V_{CM}$		Full	$(-V_S) - 0.1$		$(+V_S) + 0.1$	V
Common Mode Rejection Ratio	CMRR	$V_S = \pm 18V$ , $(-V_S) - 0.1V < V_{CM} < (+V_S) - 2V$	+25°C	95	110		dB
			Full	92			
		$V_S = \pm 18V$ , $(-V_S) - 0.1V < V_{CM} < (+V_S) + 0.1V$	+25°C	70	80		
			Full	64			
Open-Loop Voltage Gain	$A_{OL}$	$(-V_S) + 0.2V < V_{OUT} < (+V_S) - 0.2V$ , $R_L = 10k\Omega$	+25°C	98	120		dB
			Full	95			
		$(-V_S) + 0.5V < V_{OUT} < (+V_S) - 0.5V$ , $R_L = 2k\Omega$	+25°C	96	120		
			Full	75			
<b>Input Impedance</b>							
Differential	$Z_{DIFF}$	$V_S = \pm 18V$	+25°C		$10^{11} \parallel 6$		$\Omega \parallel pF$
Common Mode	$Z_{CM}$	$V_S = \pm 18V$	+25°C		$10^{12} \parallel 6$		$\Omega \parallel pF$
<b>Output Characteristics</b>							
Output Voltage Swing from Rail	$V_{OUT}$	$V_S = \pm 18V$ , $R_L = 10k\Omega$	+25°C		60	90	mV
			Full			115	
		$V_S = \pm 18V$ , $R_L = 2k\Omega$	+25°C		300	420	
			Full			560	
Output Short-Circuit Current	$I_{SC}$	$V_S = \pm 18V$	+25°C	$\pm 40$	$\pm 55$		mA
<b>Power Supply</b>							
Operating Voltage Range	$V_S$		Full	3.3		36	V
Quiescent Current/Amplifier	$I_Q$	$I_{OUT} = 0$	+25°C		1.4	1.85	mA
			Full			2.1	
Power Supply Rejection Ratio	PSRR	$V_S = 5V$ to $36V$	+25°C	100	120		dB
			Full	97			

**ELECTRICAL CHARACTERISTICS (continued)**

( $V_S = \pm 1.65V$  to  $\pm 18V$  and  $R_L = 2k\Omega$  connected to  $0V$ , Full =  $-40^\circ C$  to  $+125^\circ C$ , typical values are at  $T_A = +25^\circ C$ , unless otherwise noted.)

PARAMETER	SYMBOL	CONDITIONS	TEMP	MIN	TYP	MAX	UNITS
<b>Dynamic Performance</b>							
Gain-Bandwidth Product	GBP	$C_L = 50pF$	$+25^\circ C$		10		MHz
Phase Margin	$\phi_o$	$V_S = \pm 18V, C_L = 50pF$	$+25^\circ C$		45		$^\circ$
Slew Rate	SR	$V_S = \pm 2.5V$ to $\pm 18V, G = +1$	$+25^\circ C$		8		$V/\mu s$
Overload Recovery Time	ORT	$V_{IN} \times G > V_S$	$+25^\circ C$		1		$\mu s$
Total Harmonic Distortion + Noise	THD+N	$V_{OUT} = 2V_{P-P}, f = 1kHz, G = +1, R_L = 600\Omega$	$+25^\circ C$		0.005		%
		$V_{OUT} = 2V_{P-P}, f = 1kHz, G = +1, R_L = 2k\Omega$	$+25^\circ C$		0.0005		
<b>Noise</b>							
Input Voltage Noise		$f = 0.1Hz$ to $10Hz$	$+25^\circ C$		3		$\mu V_{P-P}$
Input Voltage Noise Density	$e_n$	$f = 10Hz$	$+25^\circ C$		80		$nV/\sqrt{Hz}$
		$f = 1kHz$	$+25^\circ C$		10		
Input Current Noise Density	$i_n$	$f = 1kHz$	$+25^\circ C$		500		$fA/\sqrt{Hz}$

**TYPICAL PERFORMANCE CHARACTERISTICS**

At  $T_A = +25^\circ\text{C}$ ,  $V_S = 36\text{V}$  and  $R_L = 2\text{k}\Omega$ , unless otherwise noted.

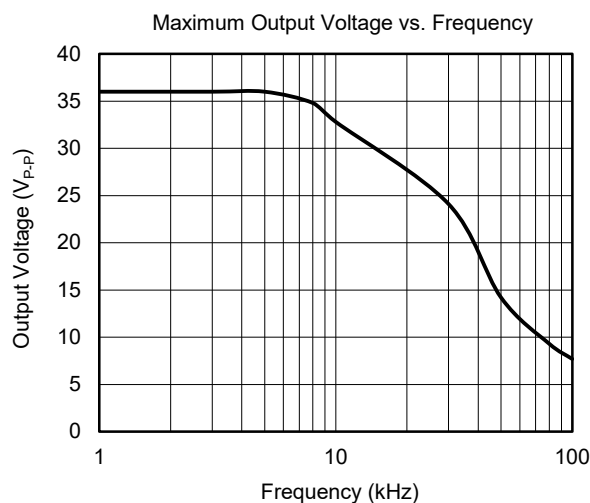
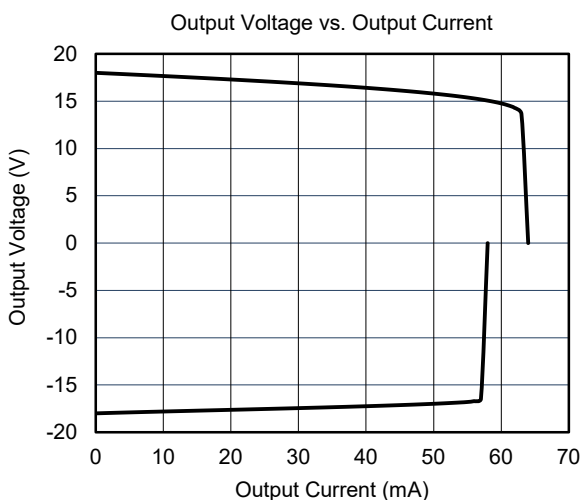
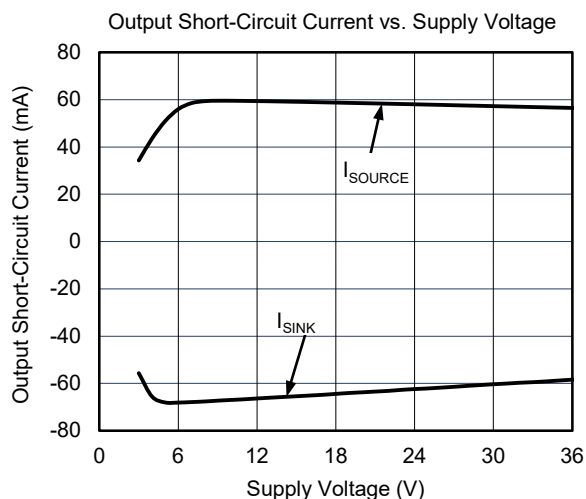
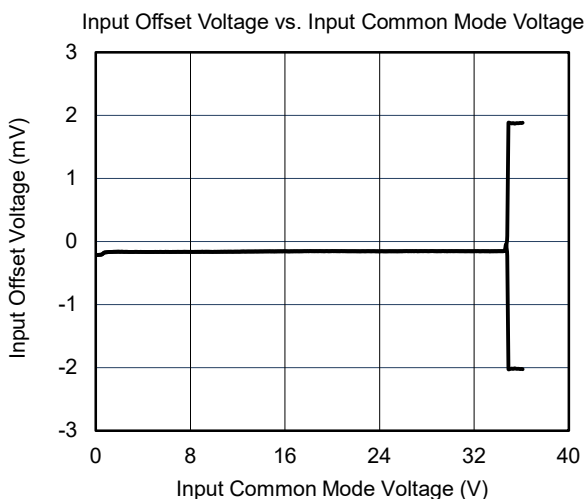
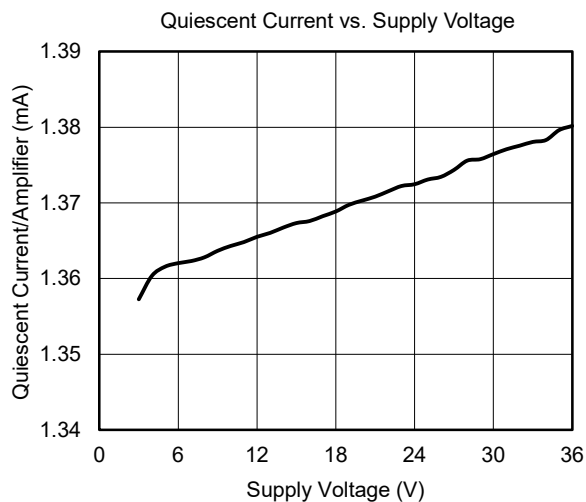
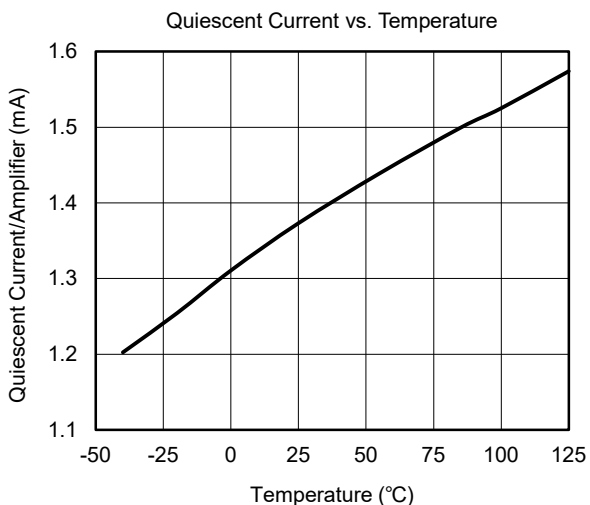

**TYPICAL PERFORMANCE CHARACTERISTICS (continued)**

At  $T_A = +25^\circ\text{C}$ ,  $V_S = 36\text{V}$  and  $R_L = 2\text{k}\Omega$ , unless otherwise noted.

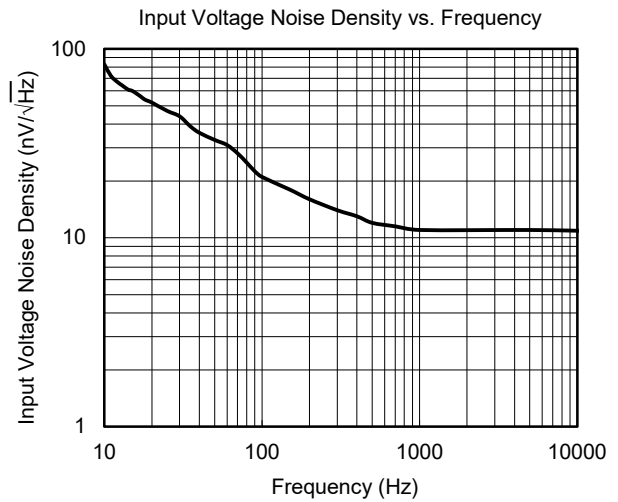
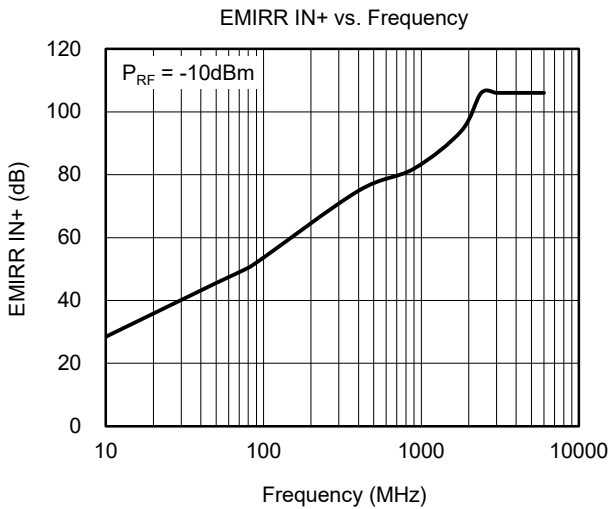
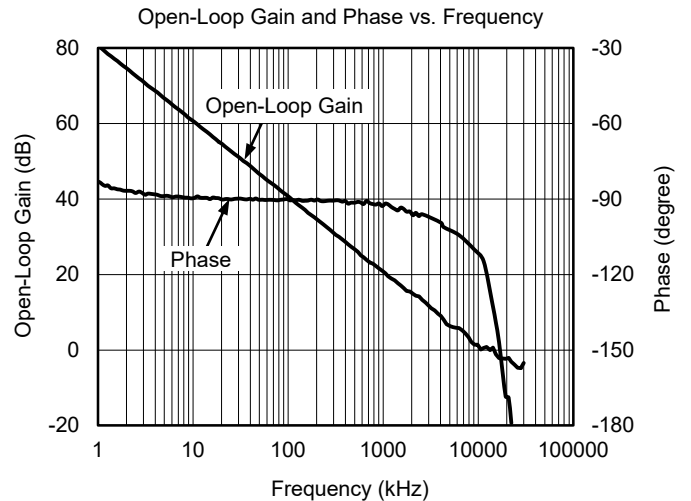
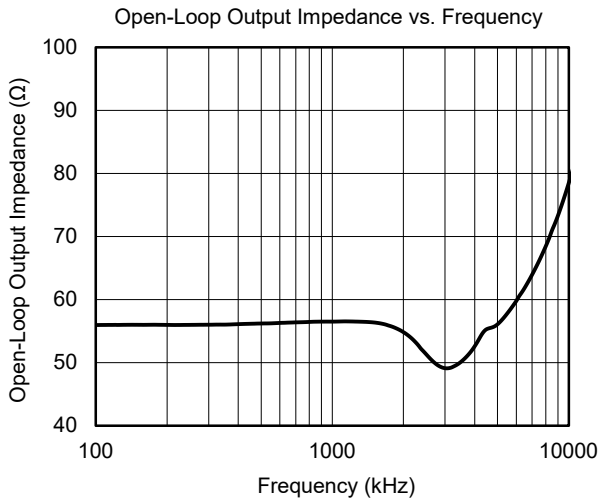
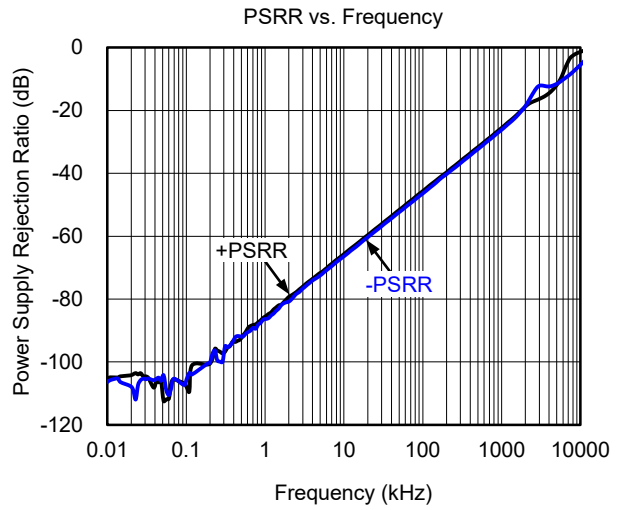
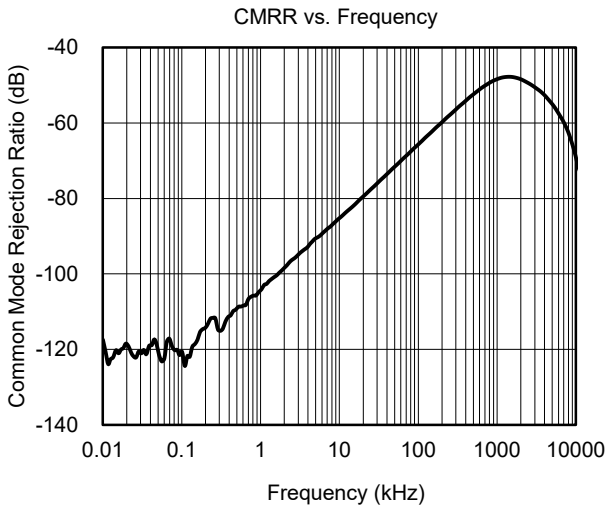

**TYPICAL PERFORMANCE CHARACTERISTICS (continued)**

At  $T_A = +25^\circ\text{C}$ ,  $V_S = 36\text{V}$  and  $R_L = 2\text{k}\Omega$ , unless otherwise noted.

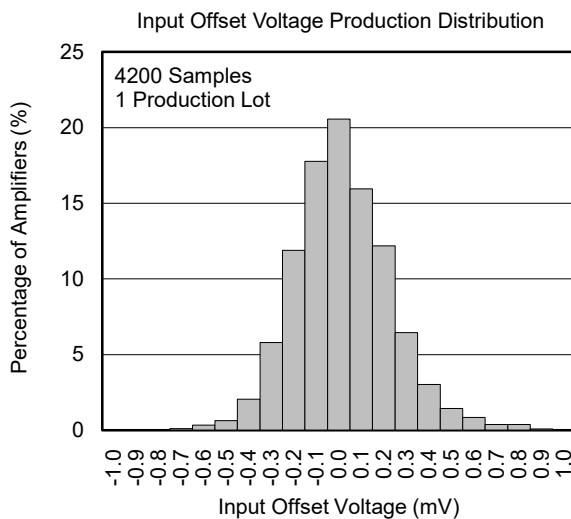
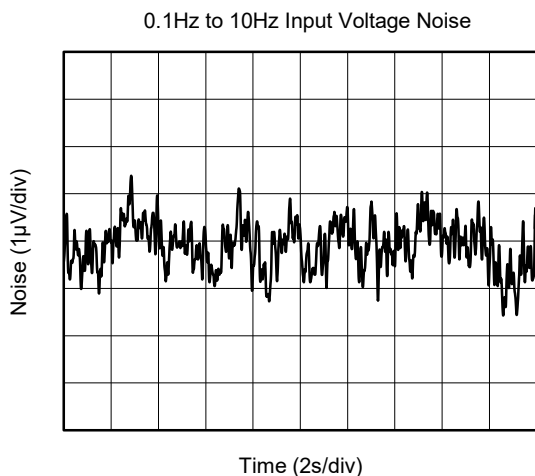
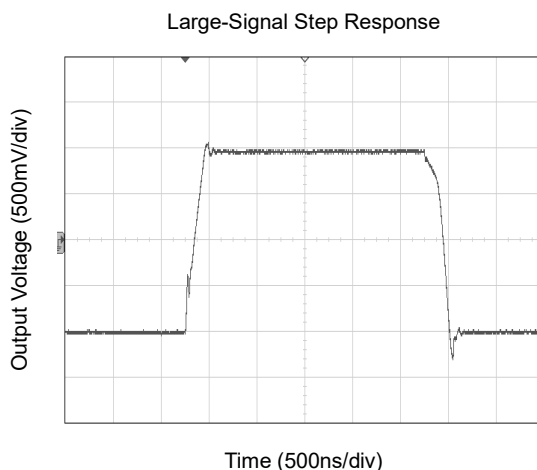
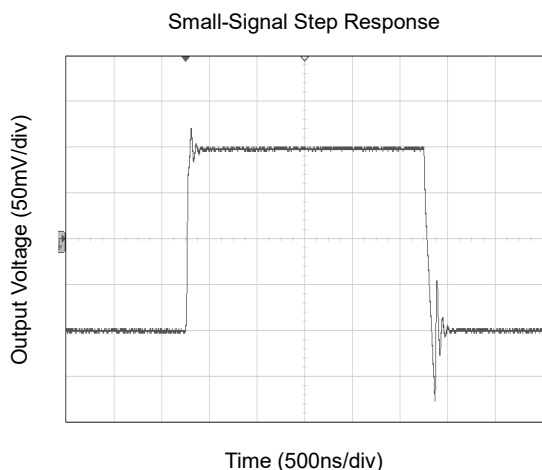
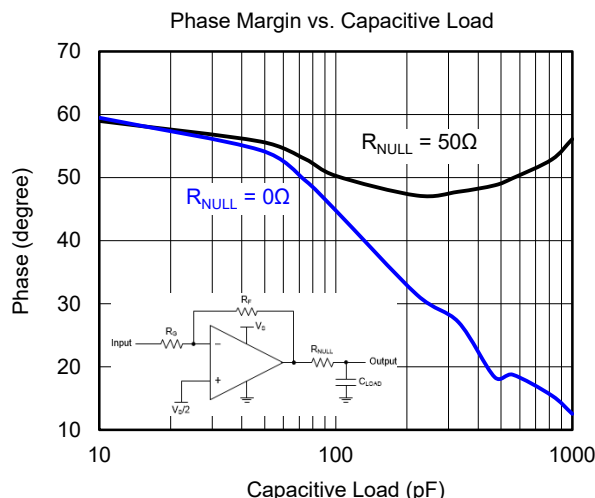
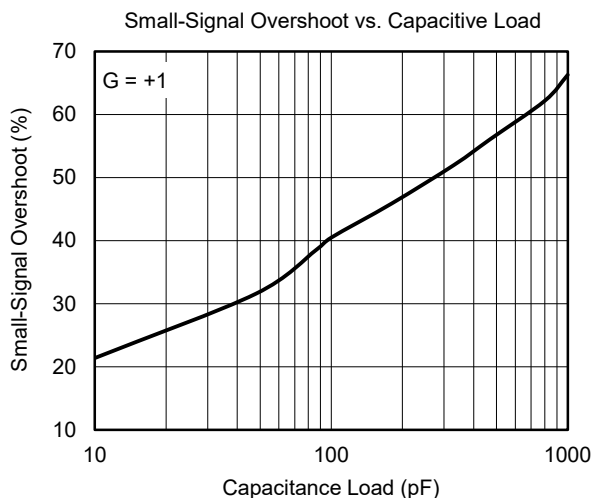



**TYPICAL PERFORMANCE CHARACTERISTICS (continued)**

At  $T_A = +25^\circ\text{C}$ ,  $V_S = 36\text{V}$  and  $R_L = 2\text{k}\Omega$ , unless otherwise noted.

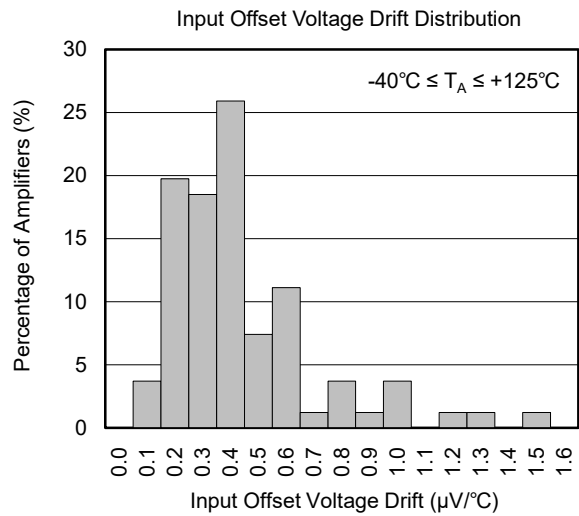
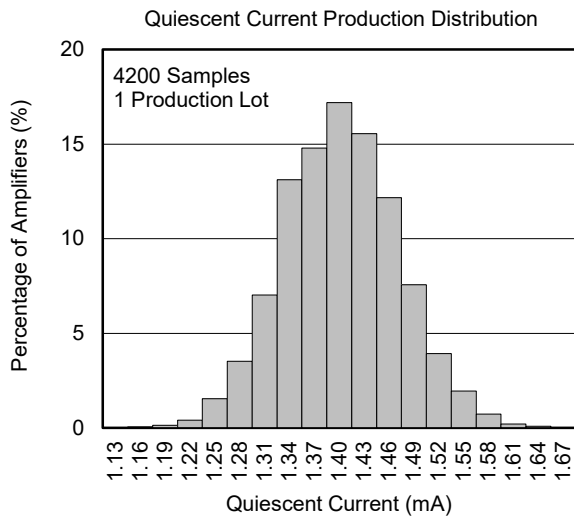

## **REVISION HISTORY**

NOTE: Page numbers for previous revisions may differ from page numbers in the current version.

### **JULY 2023 – REV.A to REV.A.1**

**Page**

---

Updated Absolute Maximum Ratings section.....	2
Updated Typical Performance Characteristics section .....	7, 8

---

### **Changes from Original (DECEMBER 2018) to REV.A**

---

Changed from product preview to production data.....	All
------------------------------------------------------	-----

---

PACKAGE OUTLINE DIMENSIONS

SOT-23-5

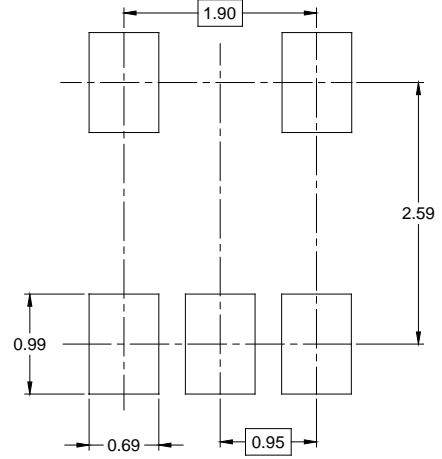
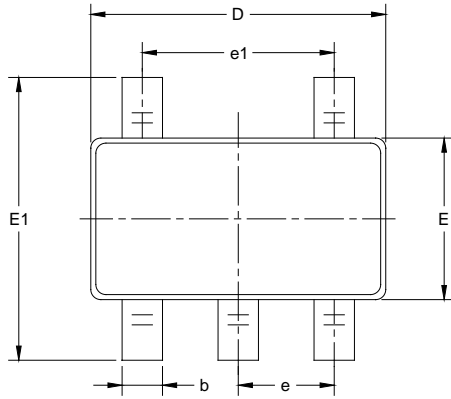

RECOMMENDED LAND PATTERN (Unit: mm)

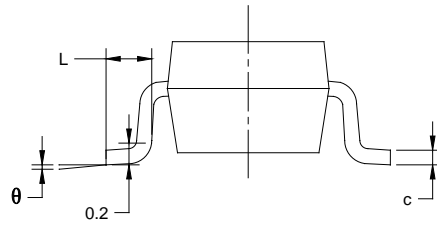
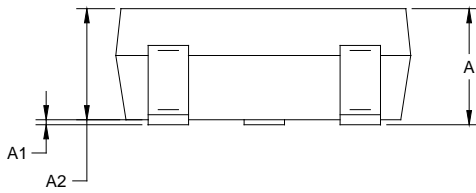

Symbol	Dimensions In Millimeters		Dimensions In Inches	
	MIN	MAX	MIN	MAX
A	1.050	1.250	0.041	0.049
A1	0.000	0.100	0.000	0.004
A2	1.050	1.150	0.041	0.045
b	0.300	0.500	0.012	0.020
c	0.100	0.200	0.004	0.008
D	2.820	3.020	0.111	0.119
E	1.500	1.700	0.059	0.067
E1	2.650	2.950	0.104	0.116
e	0.950 BSC		0.037 BSC	
e1	1.900 BSC		0.075 BSC	
L	0.300	0.600	0.012	0.024
$\theta$	0°	8°	0°	8°

NOTES:

1. Body dimensions do not include mode flash or protrusion.
2. This drawing is subject to change without notice.

PACKAGE OUTLINE DIMENSIONS

SOIC-8

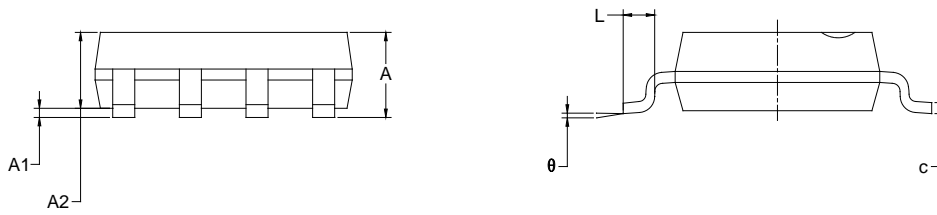
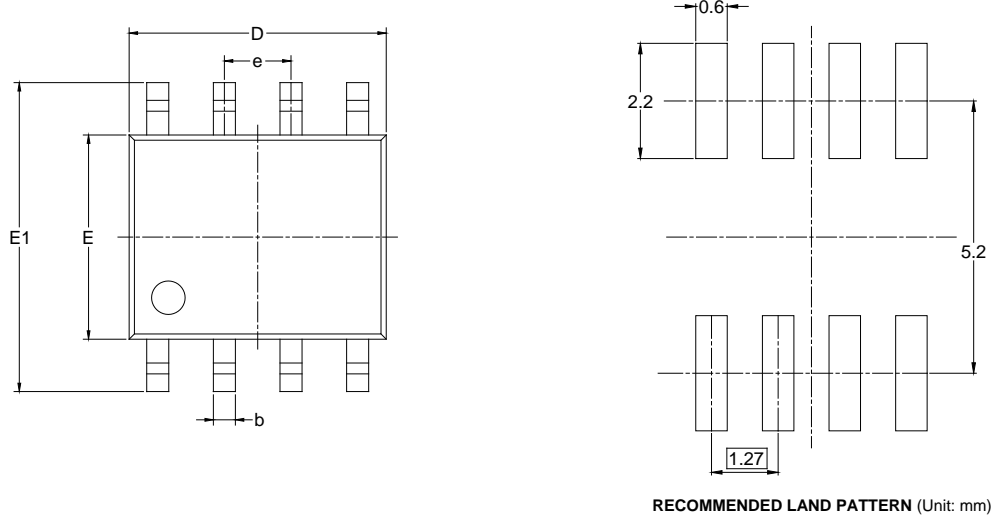

Symbol	Dimensions In Millimeters		Dimensions In Inches	
	MIN	MAX	MIN	MAX
A	1.350	1.750	0.053	0.069
A1	0.100	0.250	0.004	0.010
A2	1.350	1.550	0.053	0.061
b	0.330	0.510	0.013	0.020
c	0.170	0.250	0.006	0.010
D	4.700	5.100	0.185	0.200
E	3.800	4.000	0.150	0.157
E1	5.800	6.200	0.228	0.244
e	1.27 BSC		0.050 BSC	
L	0.400	1.270	0.016	0.050
θ	0°	8°	0°	8°

- NOTES:  
 1. Body dimensions do not include mode flash or protrusion.  
 2. This drawing is subject to change without notice.

PACKAGE OUTLINE DIMENSIONS

SOIC-14

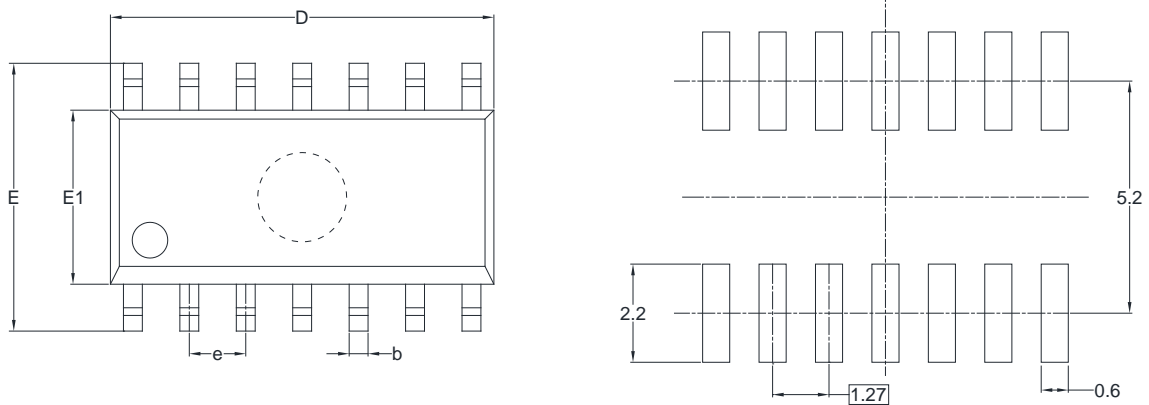

RECOMMENDED LAND PATTERN (Unit: mm)

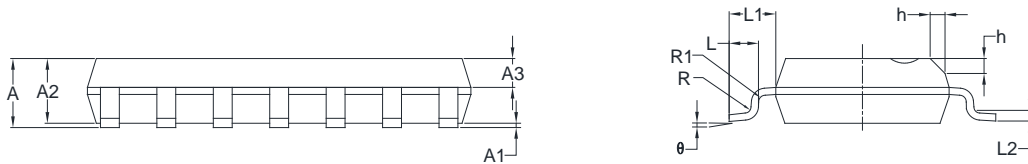

Symbol	Dimensions In Millimeters		Dimensions In Inches	
	MIN	MAX	MIN	MAX
A	1.35	1.75	0.053	0.069
A1	0.10	0.25	0.004	0.010
A2	1.25	1.65	0.049	0.065
A3	0.55	0.75	0.022	0.030
b	0.36	0.49	0.014	0.019
D	8.53	8.73	0.336	0.344
E	5.80	6.20	0.228	0.244
E1	3.80	4.00	0.150	0.157
e	1.27 BSC		0.050 BSC	
L	0.45	0.80	0.018	0.032
L1	1.04 REF		0.040 REF	
L2	0.25 BSC		0.01 BSC	
R	0.07		0.003	
R1	0.07		0.003	
h	0.30	0.50	0.012	0.020
θ	0°	8°	0°	8°

NOTES:

1. Body dimensions do not include mode flash or protrusion.
2. This drawing is subject to change without notice.

**TAPE AND REEL INFORMATION**

**REEL DIMENSIONS**



**TAPE DIMENSIONS**



NOTE: The picture is only for reference. Please make the object as the standard.

**KEY PARAMETER LIST OF TAPE AND REEL**

Package Type	Reel Diameter	Reel Width W1 (mm)	A0 (mm)	B0 (mm)	K0 (mm)	P0 (mm)	P1 (mm)	P2 (mm)	W (mm)	Pin1 Quadrant
SOT-23-5	7"	9.5	3.20	3.20	1.40	4.0	4.0	2.0	8.0	Q3
SOIC-8	13"	12.4	6.40	5.40	2.10	4.0	8.0	2.0	12.0	Q1
SOIC-14	13"	16.4	6.60	9.30	2.10	4.0	8.0	2.0	16.0	Q1

DD0001

# PACKAGE INFORMATION

## CARTON BOX DIMENSIONS



NOTE: The picture is only for reference. Please make the object as the standard.

## KEY PARAMETER LIST OF CARTON BOX

Reel Type	Length (mm)	Width (mm)	Height (mm)	Pizza/Carton
7" (Option)	368	227	224	8
7"	442	410	224	18
13"	386	280	370	5

DD0002