



# SGM8584

## Single-Supply, Quad Rail-to-Rail I/O Precision Operational Amplifier

---

### GENERAL DESCRIPTION

The SGM8584 is a quad, precision operational amplifier which can operate from 2.5V to 5.5V single supply. The device provides rail-to-rail input and output operation.

The SGM8584 offers a low offset voltage less than 100 $\mu$ V and an ultra-low bias current of 60pA. The combination of characteristics makes the SGM8584 a good choice for temperature measurements, pressure and position sensors, strain gauge amplifiers and medical instrumentation, or any other 2.5V to 5.5V applications requiring precision and long-term stability.

The SGM8584 is available in Green SOIC-14 and TSSOP-14 packages. It is specified over the extended industrial temperature range (-40°C to +125°C).

### FEATURES

- **Low Offset Voltage: 100 $\mu$ V (MAX)**
- **Ultra-Low Input Bias Current: 60pA**
- **Large-Signal Voltage Gain: 135dB (TYP) at 5V**
- **PSRR: 115dB (TYP)**
- **CMRR: 92dB (TYP)**
- **Overload Recovery Time: 30 $\mu$ s (at  $V_S = 5V$ )**
- **Rail-to-Rail Input and Output**
- **Supply Voltage Range: 2.5V to 5.5V**
- **Low Supply Current: 430 $\mu$ A/Amplifier**
- **No External Capacitors Required**
- **-40°C to +125°C Operating Temperature Range**
- **Available in Green SOIC-14 and TSSOP-14 Packages**

### APPLICATIONS

Pressure Sensors  
Temperature Measurements  
Precision Current Sensing  
Electronic Scales  
Strain Gauge Amplifiers  
Handheld Test Equipment  
Thermocouple Amplifiers  
Medical Instrumentation

**PACKAGE/ORDERING INFORMATION**

MODEL	PACKAGE DESCRIPTION	SPECIFIED TEMPERATURE RANGE	ORDERING NUMBER	PACKAGE MARKING	PACKING OPTION
SGM8584	SOIC-14	-40°C to +125°C	SGM8584XS14G/TR	SGM8584XS14 XXXXX	Tape and Reel, 2500
	TSSOP-14	-40°C to +125°C	SGM8584XTS14G/TR	SGM8584 XTS14 XXXXX	Tape and Reel, 3000

**MARKING INFORMATION**

NOTE: XXXXX = Date Code and Vendor Code.

**XXXXX**

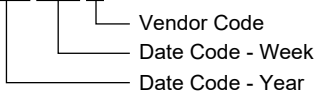

Green (RoHS & HSF): SG Micro Corp defines "Green" to mean Pb-Free (RoHS compatible) and free of halogen substances. If you have additional comments or questions, please contact your SGMICRO representative directly.

**ABSOLUTE MAXIMUM RATINGS**

- Supply Voltage ..... 6V
- Input Voltage Range ..... -V<sub>S</sub> to (+V<sub>S</sub>) + 0.1V
- Differential Input Voltage Range ..... -5V to 5V
- Junction Temperature ..... +150°C
- Storage Temperature Range..... -65°C to +150°C
- Lead Temperature (Soldering, 10s).....+260°C
- ESD Susceptibility
- HBM (TSSOP-14) ..... 8000V
- HBM (SOIC-14) ..... 7000V
- MM..... 400V

performance degradation to complete device failure. Precision integrated circuits may be more susceptible to damage because even small parametric changes could cause the device not to meet the published specifications.

**DISCLAIMER**

SG Micro Corp reserves the right to make any change in circuit design, or specifications without prior notice.

**RECOMMENDED OPERATING CONDITIONS**

- Operating Temperature Range ..... -40°C to +125°C

**OVERSTRESS CAUTION**

Stresses beyond those listed in Absolute Maximum Ratings may cause permanent damage to the device. Exposure to absolute maximum rating conditions for extended periods may affect reliability. Functional operation of the device at any conditions beyond those indicated in the Recommended Operating Conditions section is not implied.

**ESD SENSITIVITY CAUTION**

This integrated circuit can be damaged if ESD protections are not considered carefully. SGMICRO recommends that all integrated circuits be handled with appropriate precautions. Failure to observe proper handling and installation procedures can cause damage. ESD damage can range from subtle

**PIN CONFIGURATIONS**

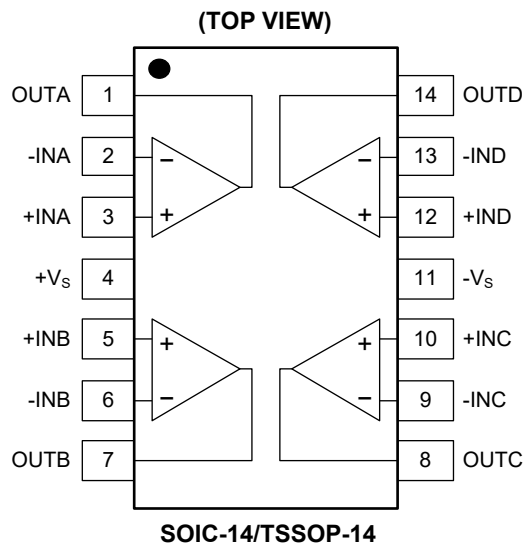

**ELECTRICAL CHARACTERISTICS**(V<sub>S</sub> = 5V, V<sub>CM</sub> = 2.5V, V<sub>OUT</sub> = 2.5V, Full = -40°C to +125°C, typical values are at T<sub>A</sub> = +25°C, unless otherwise noted.)

PARAMETER	CONDITIONS	TEMP	MIN	TYP	MAX	UNITS
<b>Input Characteristics</b>						
Input Offset Voltage (V <sub>OS</sub> )		+25°C		25	100	μV
		Full			110	
Input Offset Voltage Drift (ΔV <sub>OS</sub> /ΔT)		Full		150		nV/°C
Input Bias Current (I <sub>B</sub> )		+25°C		60		pA
Input Offset Current (I <sub>OS</sub> )		+25°C		50		pA
Input Voltage Range		+25°C	0		5	V
Common Mode Rejection Ratio <sup>(1)</sup> (CMRR)	V <sub>CM</sub> = 0V to 5V	+25°C	88	92		dB
		Full	77			
Large-Signal Voltage Gain (A <sub>VO</sub> )	R <sub>L</sub> = 10kΩ, V <sub>OUT</sub> = 0.3V to 4.7V	+25°C	120	135		dB
		Full	104			
<b>Output Characteristics</b>						
Output Voltage High (V <sub>OH</sub> )	R <sub>L</sub> = 100kΩ to -V <sub>S</sub>	+25°C	4.9	4.998		V
		Full	4.894			
	R <sub>L</sub> = 10kΩ to -V <sub>S</sub>	+25°C	4.9	4.994		
		Full	4.888			
Output Voltage Low (V <sub>OL</sub> )	R <sub>L</sub> = 100kΩ to +V <sub>S</sub>	+25°C		3.5	6	mV
		Full			8	
	R <sub>L</sub> = 10kΩ to +V <sub>S</sub>	+25°C		7	10	
		Full			23	
Short-Circuit Limit (I <sub>SC</sub> )	V <sub>OUT</sub> = 2.5V, R <sub>L</sub> = 10Ω to GND	+25°C	30	40		mA
		Full	22			
<b>Power Supply</b>						
Power Supply Rejection Ratio <sup>(1)</sup> (PSRR)	V <sub>S</sub> = 2.5V to 5.5V	+25°C	90	115		dB
		Full	80			
Quiescent Current/Amplifier (I <sub>Q</sub> )	V <sub>OUT</sub> = V <sub>S</sub> /2	+25°C		430	555	μA
		Full			710	
<b>Dynamic Performance</b>						
Gain-Bandwidth Product (GBP)	A <sub>V</sub> = +100	+25°C		1.5		MHz
Slew Rate (SR)	A <sub>V</sub> = +1, R <sub>L</sub> = 10kΩ, 2V output step	+25°C		0.9		V/μs
Overload Recovery Time	A <sub>V</sub> = -100, R <sub>L</sub> = 10kΩ, V <sub>IN</sub> = 200mV (RET to GND)	+25°C		0.03		ms
<b>Noise</b>						
Input Voltage Noise	0.1Hz to 10Hz	+25°C		1.4		μV <sub>P-P</sub>
Input Voltage Noise Density (e <sub>n</sub> )	f = 1kHz	+25°C		78		nV/√Hz

NOTE: 1. PSRR and CMRR are affected by the matching between external gain-setting resistor ratios.

**ELECTRICAL CHARACTERISTICS (continued)**(V<sub>S</sub> = 2.5V, V<sub>CM</sub> = 1.25V, V<sub>OUT</sub> = 1.25V, Full = -40°C to +125°C, typical values are at T<sub>A</sub> = +25°C, unless otherwise noted.)

PARAMETER	CONDITIONS	TEMP	MIN	TYP	MAX	UNITS
<b>Input Characteristics</b>						
Input Offset Voltage (V <sub>OS</sub> )		+25°C		25	100	μV
		Full			120	
Input Offset Voltage Drift (ΔV <sub>OS</sub> /ΔT)		Full		150		nV/°C
Input Bias Current (I <sub>B</sub> )		+25°C		30		pA
Input Offset Current (I <sub>OS</sub> )		+25°C		20		pA
Input Voltage Range		+25°C	0		2.5	V
Common Mode Rejection Ratio <sup>(1)</sup> (CMRR)	V <sub>CM</sub> = 0V to 2.5V	+25°C	79	85		dB
		Full	70			
Large-Signal Voltage Gain (A <sub>VO</sub> )	R <sub>L</sub> = 10kΩ, V <sub>OUT</sub> = 0.3V to 2.4V	+25°C	120	130		dB
		Full	104			
<b>Output Characteristics</b>						
Output Voltage High (V <sub>OH</sub> )	R <sub>L</sub> = 100kΩ to -V <sub>S</sub>	+25°C	2.4	2.499		V
		Full	2.38			
	R <sub>L</sub> = 10kΩ to -V <sub>S</sub>	+25°C	2.4	2.497		
		Full	2.389			
Output Voltage Low (V <sub>OL</sub> )	R <sub>L</sub> = 100kΩ to +V <sub>S</sub>	+25°C		4	6	mV
		Full			7	
	R <sub>L</sub> = 10kΩ to +V <sub>S</sub>	+25°C		6	8	
		Full			12	
Short-Circuit Limit (I <sub>SC</sub> )	V <sub>OUT</sub> = 1.25V, R <sub>L</sub> = 10Ω to GND	+25°C	20	28		mA
		Full	13			
<b>Power Supply</b>						
Power Supply Rejection Ratio <sup>(1)</sup> (PSRR)	V <sub>S</sub> = 2.5V to 5.5V	+25°C	90	115		dB
		Full	80			
Quiescent Current/Amplifier (I <sub>Q</sub> )	V <sub>OUT</sub> = V <sub>S</sub> /2	+25°C		430	550	μA
		Full			710	
<b>Dynamic Performance</b>						
Gain-Bandwidth Product (GBP)	A <sub>V</sub> = +100	+25°C		1.5		MHz
Slew Rate (SR)	A <sub>V</sub> = +1, R <sub>L</sub> = 10kΩ, 2V output step	+25°C		1.0		V/μs
Overload Recovery Time	A <sub>V</sub> = -100, R <sub>L</sub> = 10kΩ, V <sub>IN</sub> = 200mV (RET to GND)	+25°C		0.02		ms
<b>Noise</b>						
Input Voltage Noise	0.1Hz to 10Hz	+25°C		1.7		μV <sub>P-P</sub>
Input Voltage Noise Density (e <sub>n</sub> )	f = 1kHz	+25°C		108		nV/√Hz

NOTE: 1. PSRR and CMRR are affected by the matching between external gain-setting resistor ratios.

TYPICAL PERFORMANCE CHARACTERISTICS

Large-Signal Step Response

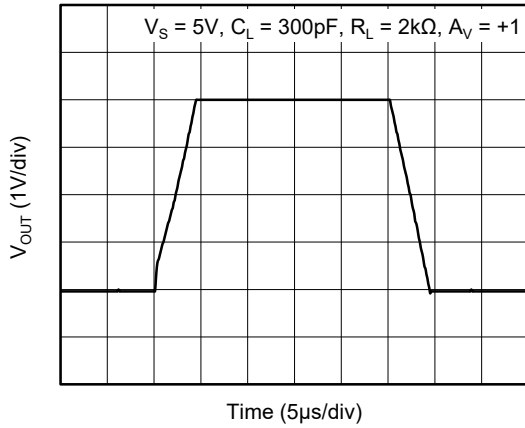

Large-Signal Step Response

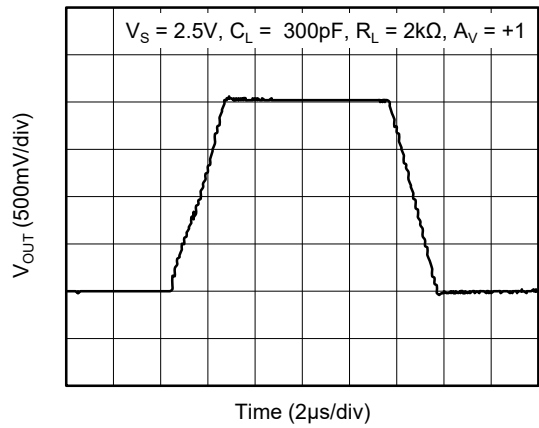

Small-Signal Step Response

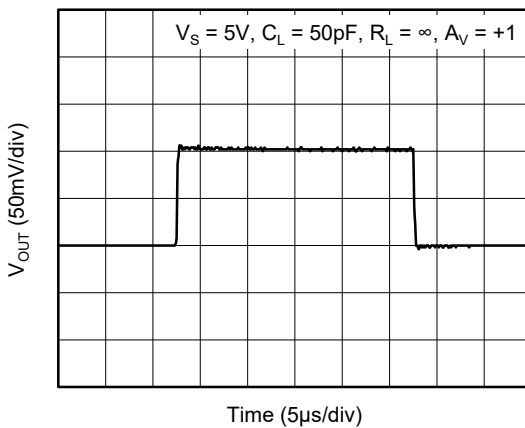

Small-Signal Step Response

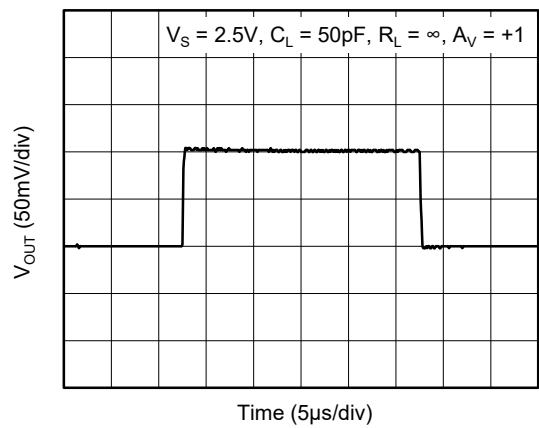

Negative Over-Voltage Recovery

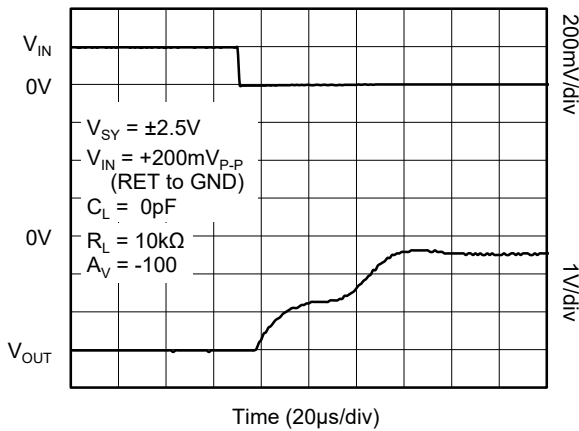

Positive Over-Voltage Recovery

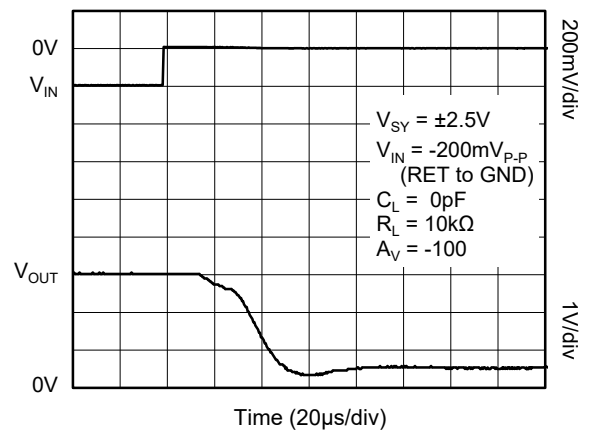

TYPICAL PERFORMANCE CHARACTERISTICS (continued)

0.1Hz to 10Hz Input Voltage Noise

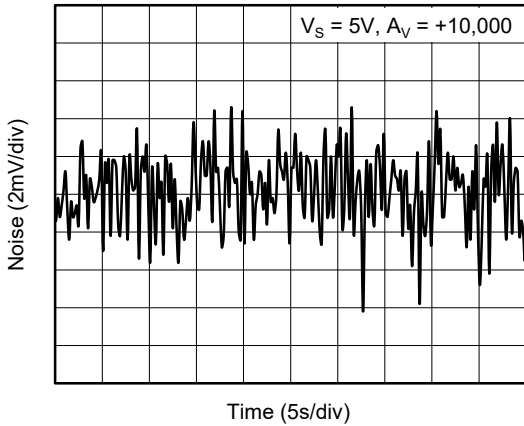

0.1Hz to 10Hz Input Voltage Noise

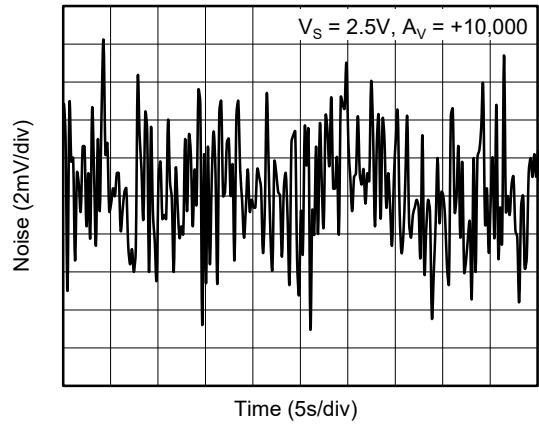

Input Voltage Noise Density vs. Frequency

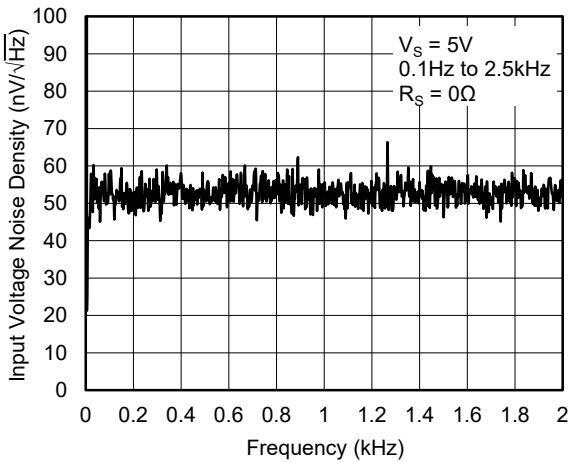

Input Voltage Noise Density vs. Frequency

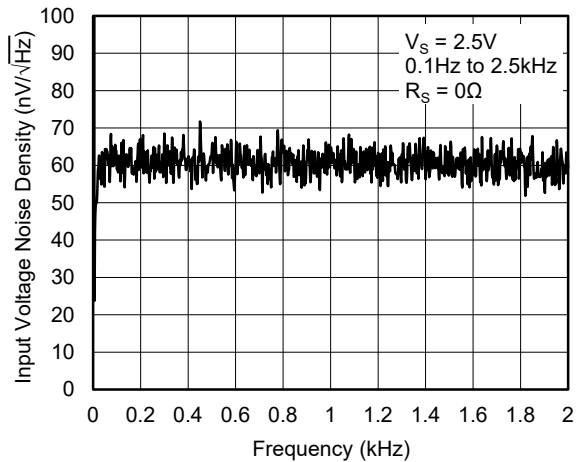

Input Voltage Noise Density vs. Frequency

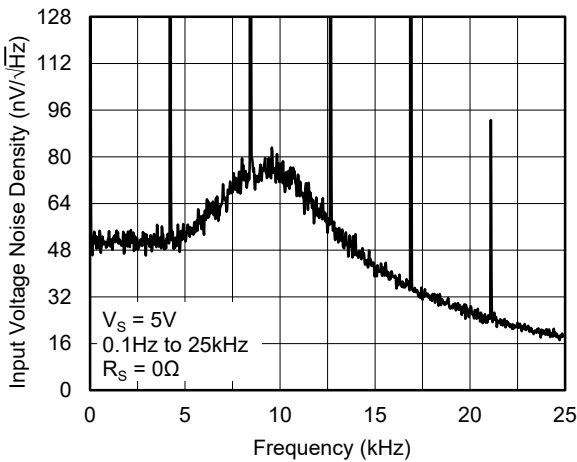

Input Voltage Noise Density vs. Frequency

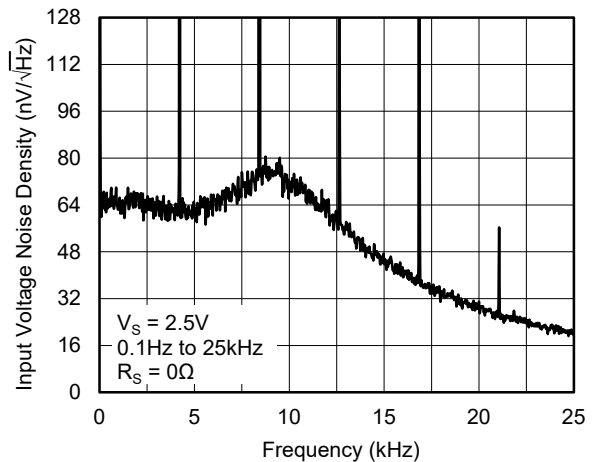

TYPICAL PERFORMANCE CHARACTERISTICS (continued)

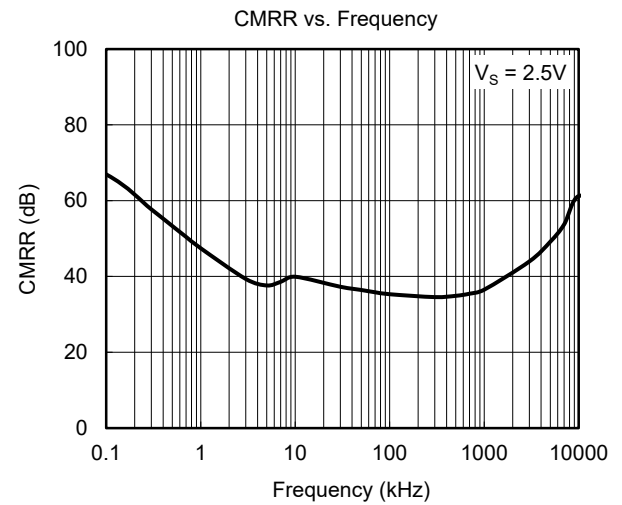
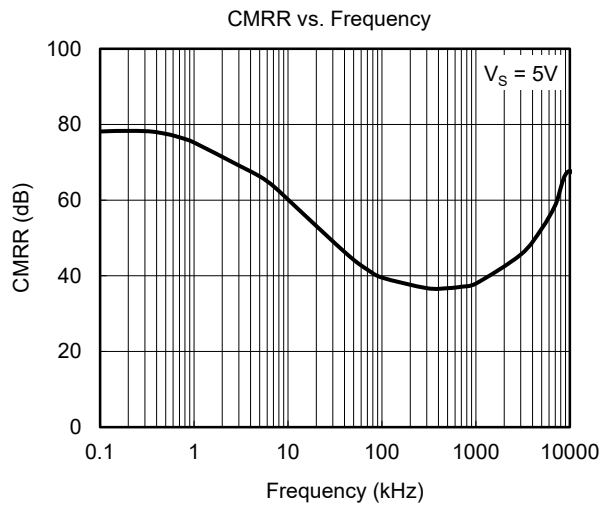
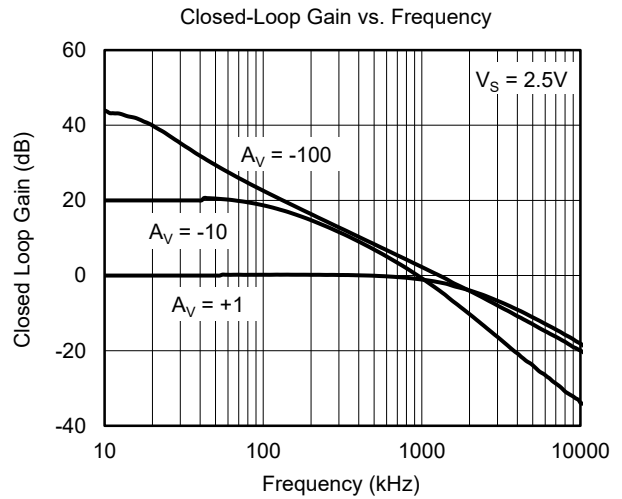
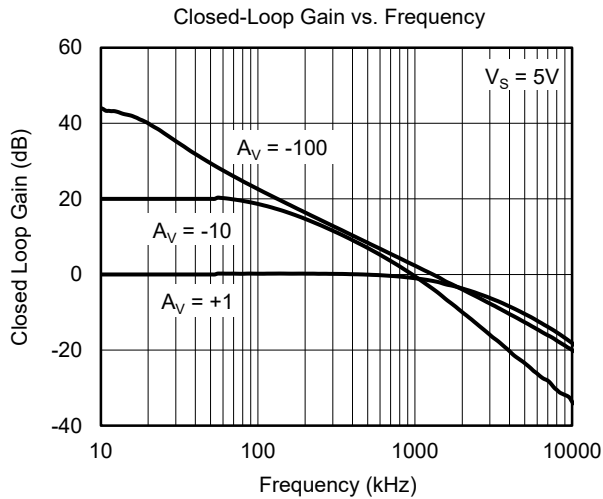
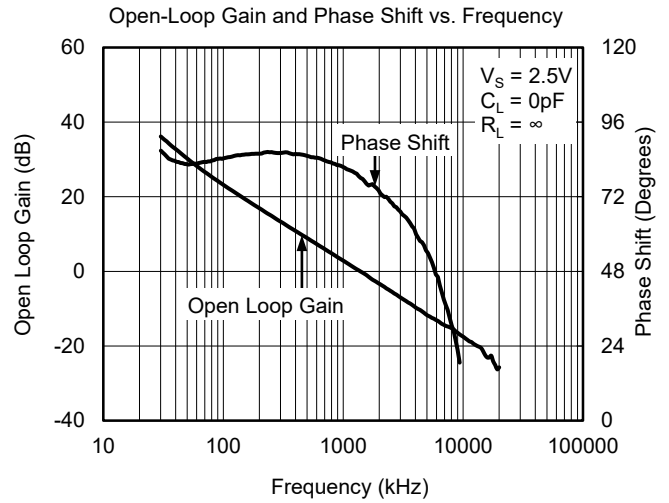
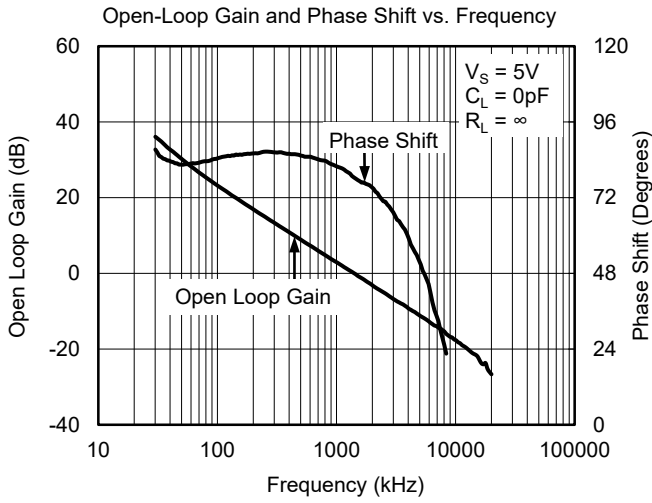

TYPICAL PERFORMANCE CHARACTERISTICS (continued)

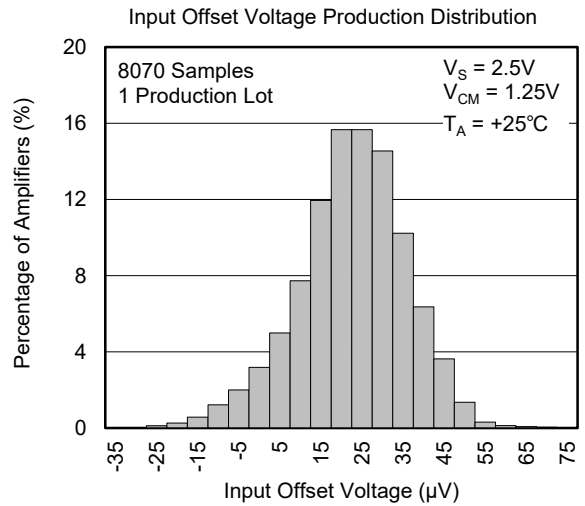
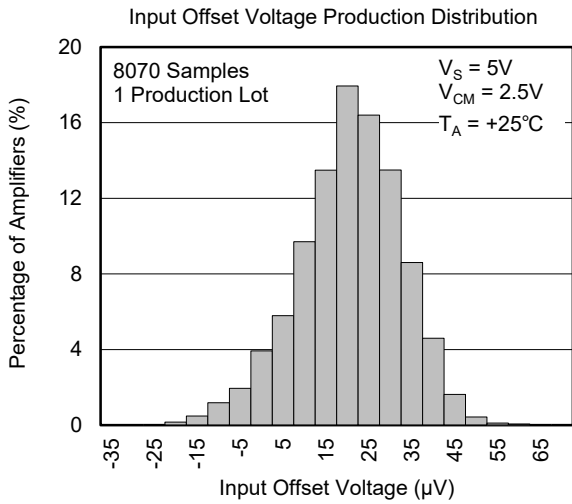
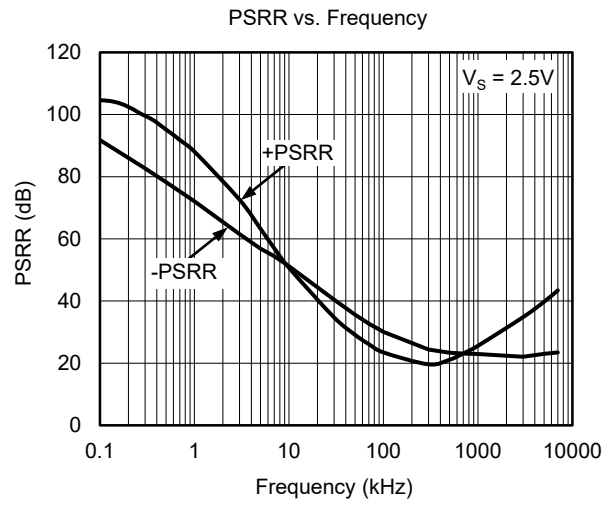
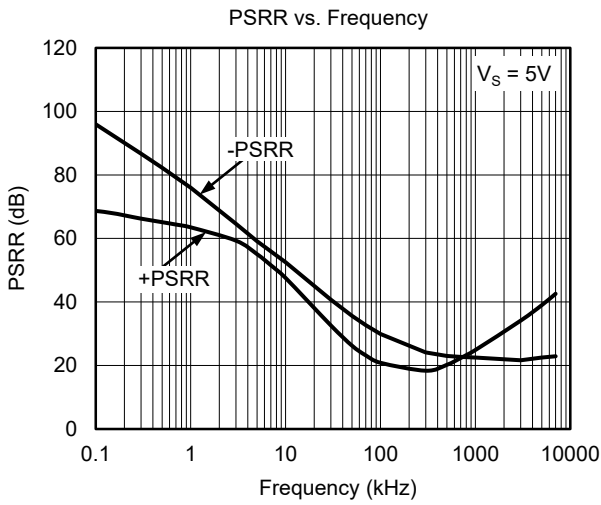



**REVISION HISTORY**

NOTE: Page numbers for previous revisions may differ from page numbers in the current version.

<b>JUNE 2019 – REV.A.3 to REV.A.4</b>		<b>Page</b>
Updated Typical Performance Characteristics section .....		8
<b>JANUARY 2013 – REV.A.2 to REV.A.3</b>		<b>Page</b>
Added Tape and Reel Information section .....		11, 12
<b>DECEMBER 2011 – REV.A.1 to REV.A.2</b>		<b>Page</b>
Updated Electrical Characteristics section .....		3, 4
Updated Typical Performance Characteristics section .....		7
Updated Package Outline Dimensions section .....		9~11
<b>MAY 2011 – REV.A to REV.A.1</b>		<b>Page</b>
Changed packages' name .....		All
<b>Changes from Original (MARCH 2010) to REV.A</b>		<b>Page</b>
Changed from product preview to production data .....		All

# PACKAGE INFORMATION

## PACKAGE OUTLINE DIMENSIONS

### SOIC-14

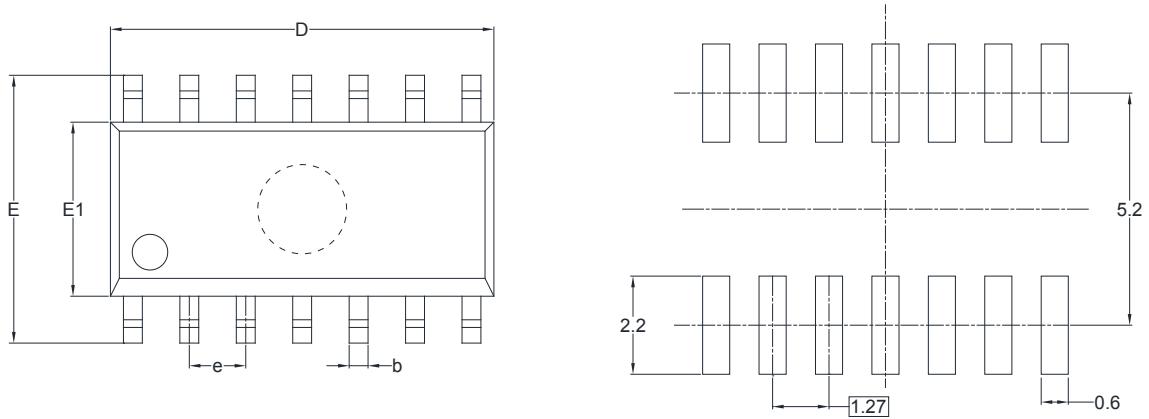

RECOMMENDED LAND PATTERN (Unit: mm)

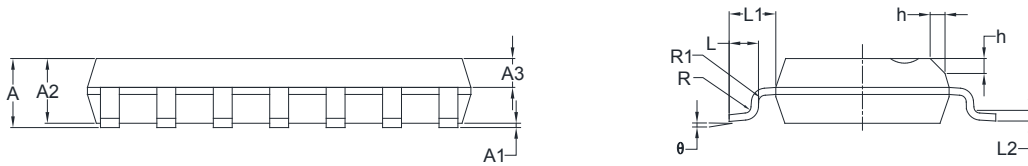

Symbol	Dimensions In Millimeters		Dimensions In Inches	
	MIN	MAX	MIN	MAX
A	1.35	1.75	0.053	0.069
A1	0.10	0.25	0.004	0.010
A2	1.25	1.65	0.049	0.065
A3	0.55	0.75	0.022	0.030
b	0.36	0.49	0.014	0.019
D	8.53	8.73	0.336	0.344
E	5.80	6.20	0.228	0.244
E1	3.80	4.00	0.150	0.157
e	1.27 BSC		0.050 BSC	
L	0.45	0.80	0.018	0.032
L1	1.04 REF		0.040 REF	
L2	0.25 BSC		0.01 BSC	
R	0.07		0.003	
R1	0.07		0.003	
h	0.30	0.50	0.012	0.020
θ	0°	8°	0°	8°

PACKAGE OUTLINE DIMENSIONS

TSSOP-14

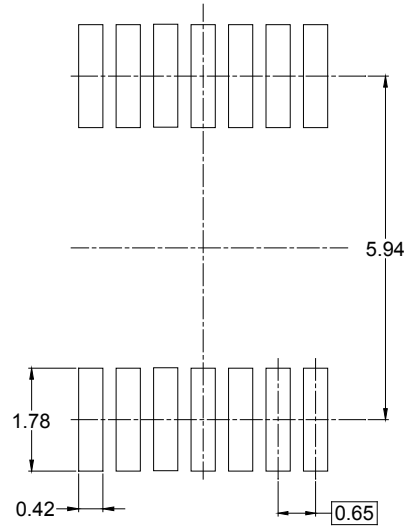
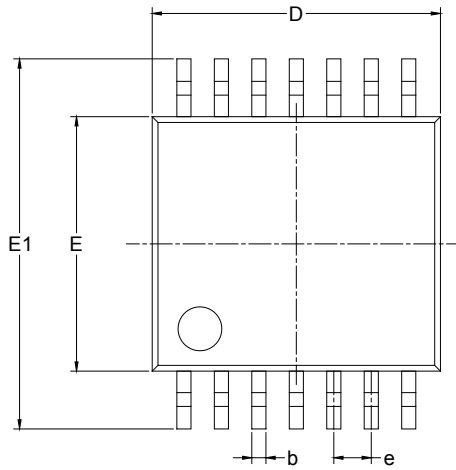

RECOMMENDED LAND PATTERN (Unit: mm)

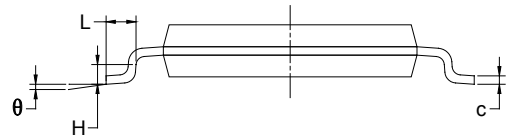
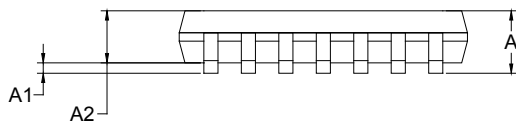

Symbol	Dimensions In Millimeters		Dimensions In Inches	
	MIN	MAX	MIN	MAX
A		1.200		0.047
A1	0.050	0.150	0.002	0.006
A2	0.800	1.050	0.031	0.041
b	0.190	0.300	0.007	0.012
c	0.090	0.200	0.004	0.008
D	4.860	5.100	0.191	0.201
E	4.300	4.500	0.169	0.177
E1	6.250	6.550	0.246	0.258
e	0.650 BSC		0.026 BSC	
L	0.500	0.700	0.02	0.028
H	0.25 TYP		0.01 TYP	
$\theta$	1°	7°	1°	7°

## TAPE AND REEL INFORMATION

### REEL DIMENSIONS

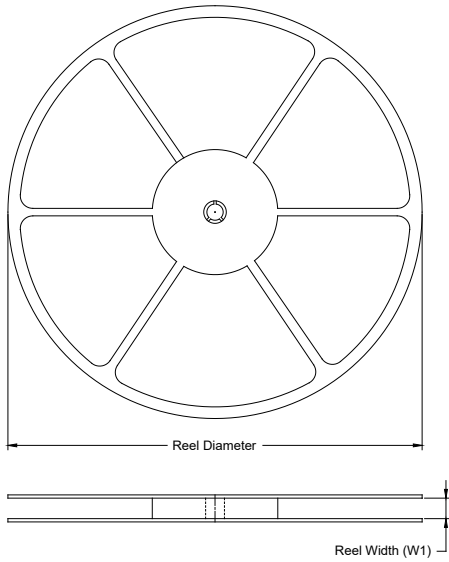

### TAPE DIMENSIONS



NOTE: The picture is only for reference. Please make the object as the standard.

### KEY PARAMETER LIST OF TAPE AND REEL

Package Type	Reel Diameter	Reel Width W1 (mm)	A0 (mm)	B0 (mm)	K0 (mm)	P0 (mm)	P1 (mm)	P2 (mm)	W (mm)	Pin1 Quadrant
SOIC-14	13"	16.4	6.60	9.30	2.10	4.0	8.0	2.0	16.0	Q1
TSSOP-14	13"	12.4	6.95	5.60	1.20	4.0	8.0	2.0	12.0	Q1

000001

# PACKAGE INFORMATION

## CARTON BOX DIMENSIONS



NOTE: The picture is only for reference. Please make the object as the standard.

## KEY PARAMETER LIST OF CARTON BOX

Reel Type	Length (mm)	Width (mm)	Height (mm)	Pizza/Carton
13"	386	280	370	5

DD0002