

GENERAL DESCRIPTION

The SGM4073 can be used as reset timer as well as load management switch. The device is very suitable for highly integrated applications.

When the mobile device is turned off, press the start key to keep the PMIC at a logic low level for 1.9s to turn on the PMIC.

Since the Quiescent Current of the SGM4073 is as low as 1 μ A (TYP), it supports direct interface with low-voltage chipsets and can maintain low power consumption.

When the device is used as a reset timer, disconnecting the PMIC from the battery power for 468ms will produce a fixed delay time of 7.7s. The delay time can be adjusted by an external resistor connected between the DELAY_ADJ pin and ground.

The SGM4073 also can be used as a load management switch. It can disconnect loads with high shutdown current and high load capacitance (< 200 μ F) powered by a supply voltage lower than 6V. The SGM4073 provides a 20m Ω on-resistance when V_{BAT} is 3.6V.

The SGM4073 is available in a Green WLCSP-1.31 \times 1.62-12B package. It operates over an ambient temperature range of -40 $^{\circ}$ C to +85 $^{\circ}$ C.

FEATURES

- **Supply Voltage Range: 1.5V to 5.5V**
- **Factory-Set parameters:**
 - ♦ **Reset Delay Time: 7.7s**
 - ♦ **Reset Pulse: 468ms**
 - ♦ **Turn-On Time: 1.9s**
 - ♦ **Turn-Off Delay: 7.7s**
- **Adjustable Reset Delay Time**
- **6A Maximum Continuous Current**
- **20m Ω (TYP) On-Resistance at $V_{BAT} = 3.6V$**
- **Output Capacitor Discharge during Reset Period**
- **Slew Rate or Inrush Control with t_R : 3ms (TYP)**
- **Enable Zero-Second Test**
- **Available in a Green WLCSP-1.31 \times 1.62-12B Package**

APPLICATIONS

Computers
Battery
Portable Equipment
Storage Equipment

PACKAGE/ORDERING INFORMATION

MODEL	PACKAGE DESCRIPTION	SPECIFIED TEMPERATURE RANGE	ORDERING NUMBER	PACKAGE MARKING	PACKING OPTION
SGM4073	WLCSP-1.31×1.62-12B	-40°C to +85°C	SGM4073YG/TR	XXXX 4073	Tape and Reel, 3000

MARKING INFORMATION

NOTE: XXXX = Date Code.

XXXX

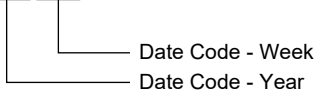

Green (RoHS & HSF): SG Micro Corp defines "Green" to mean Pb-Free (RoHS compatible) and free of halogen substances. If you have additional comments or questions, please contact your SGMICRO representative directly.

ABSOLUTE MAXIMUM RATINGS

- V_{BAT} to GND..... -0.3V to 6.5V
- V_{OUT} to GND -0.3V to 6.5V
- Maximum Continuous Switch Current..... 6A
- Power Dissipation, P_D @ T_A = 25°C, I_{OUT} = 6A, R_{ON} = 20mΩ
..... 0.72W
- Package Thermal Resistance
WLCSP-1.31×1.62-12B, θ_{JA} 86°C/W
- DC Input Voltage
nSR0, DSR, OFF, DELAY_ADJ, SYS_WAKE.. -0.5V to 6.5V
- DC Input Diode Current, V_{BAT} < 0V..... -50mA
- Junction Temperature +150°C
- Storage Temperature Range -65°C to +150°C
- Lead Temperature (Soldering, 10s)..... +260°C
- ESD
HBM..... 8000V
MM..... 400V
CDM 1000V

RECOMMENDED OPERATING CONDITIONS

- Input Voltage Range
V_{BAT}..... 1.5V to 5.5V
- nSR0, DSR, OFF, SYS_WAKE..... 0V to 5.5V
- Output Voltage Range 0V to V_{BAT}
- Operating Temperature Range -40°C to +85°C

OVERSTRESS CAUTION

Stresses beyond those listed in Absolute Maximum Ratings may cause permanent damage to the device. Exposure to absolute maximum rating conditions for extended periods may affect reliability. Functional operation of the device at any conditions beyond those indicated in the Recommended Operating Conditions section is not implied.

ESD SENSITIVITY CAUTION

This integrated circuit can be damaged if ESD protections are not considered carefully. SGMICRO recommends that all integrated circuits be handled with appropriate precautions. Failure to observe proper handling and installation procedures can cause damage. ESD damage can range from subtle performance degradation to complete device failure. Precision integrated circuits may be more susceptible to damage because even small parametric changes could cause the device not to meet the published specifications.

DISCLAIMER

SG Micro Corp reserves the right to make any change in circuit design, or specifications without prior notice.

PIN CONFIGURATION

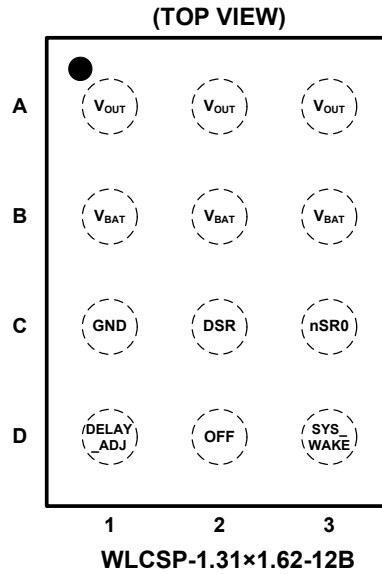

PIN DESCRIPTION

PIN	NAME	FUNCTION	
		Normal Operation	Zero-Second Factory-Test Mode (Only for t_{VON} and t_{PHL})
A1, A2, A3	V_{OUT}	Switch Output Pin.	Switch Output Pin.
B1, B2, B3	V_{BAT}	Power Supply Pin.	Power Supply Pin.
C1	GND	Ground Pin.	Ground Pin.
C2	DSR	Delay Selected Input Pin. Connect to GPIO with a 100k Ω pull-up resistor or connect to V_{BAT} directly.	Logic low.
C3	nSR0	Power-On or Reset Input Pin. Active low. Dampproof and anti-creeping input.	Logic low.
D1	DELAY_ADJ	Adjustable Reset Delay Time Pin. To adjust the reset delay, a resistor (R_{ADJ}) is connected between this pin and ground. If not used, connect this pin to V_{BAT} directly.	Connect to V_{BAT} or GND.
D2	OFF	Load Switch Disable Pin. When the rising edge is triggered, the load switch changes to off state. Don't leave this pin floating.	Logic high or low.
D3	SYS_WAKE	System Wake-Up Input Pin. The load switch changes to on state. Dampproof and anti-creeping input.	Logic high or low.

ELECTRICAL CHARACTERISTICS

(V_{BAT} = 3.6V and T_A = +25°C, unless otherwise noted.)

PARAMETER	SYMBOL	CONDITIONS	MIN	TYP	MAX	UNITS
BASIC OPERATION						
Shutdown Current	I _{SD}	V _{OUT} Floating, Load Switch = OFF		0.7	1.5	μA
On Resistance	R _{ON}	V _{BAT} = 5.5V, I _{OUT} = 500mA		18	36	mΩ
		V _{BAT} = 3.6V, I _{OUT} = 500mA		20	37	
		V _{BAT} = 1.5V, I _{OUT} = 500mA		42	87	
Output Discharge R _{PULL-DOWN}	R _{PD}	Reset Period, I _{FORCE} = 10mA		65	90	Ω
Input High Voltage	V _{IH}		1.2			V
Input Low Voltage	V _{IL}				0.4	V
Input Leakage Current ⁽¹⁾	I _{IN}	0V ≤ V _{BAT} ≤ 5.5V			1.5	μA
Power-On Reset Threshold	V _{POR}			1.38	1.5	V
	V _{HYS}			0.1		
Quiescent Current	I _Q	nSR0 = 3.6V, DSR = 3.6V, SYS_WAKE = GND, OFF = GND, I _{OUT} = 0mA, Load Switch = ON		1	2	μA
Force Voltage Threshold	V _{COERU}	SYS_WAKE up going		0.7		V
	V _{COERD}	nSR0 down going		0.6		
Force Current Threshold	I _{COERSNK}	SYS_WAKE up going		-50		μA
	I _{COERSRC}	nSR0 down going		45		
Discharging Residual Voltage	V _{DIS}			0.4		V
POWER-ON AND RESET TIMING						
Turn-On Time for V _{OUT}	t _{VON}	R _L = 5kΩ, DSR = HIGH, Figure 1	1.4	1.9	2.4	s
Timer Delay before Reset	t _{PHL}	R _L = 5kΩ, DSR = HIGH, Figure 2	6.2	7.7	9.2	s
Reset Timeout Delay of V _{OUT}	t _{REC}	R _L = 5kΩ, Figure 2	376	468	541	ms
LOAD SWITCH TURN-ON TIMING						
Turn-On Delay Time	t _{DON}	R _L = 5Ω, C _L = 100μF, Figure 3		4		ms
V _{OUT} Rise Time	t _R			3		ms
Turn-On Time, SYS_WAKE to V _{OUT}	t _{ON}			7		ms
LOAD SWITCH TURN-OFF WITH DELAY						
Delay to Turn Off Load Switch	t _{SD}	R _L = 150Ω, C _L = 100μF, DSR = HIGH, Figure 4	6.2	7.7	9.2	s
V _{OUT} Fall Time	t _F				10	ms
Turn-Off Time	t _{OFF}				7.7	s
LOAD SWITCH ZERO-SECOND TURN-OFF						
Delay to Turn Off Load Switch	t _{SD}	R _L = 150Ω, C _L = 100μF, DSR = LOW, Figure 4		2		ms
V _{OUT} Fall Time	t _F				10	ms
Turn-Off Time	t _{OFF}				12	ms
ZERO-SECOND FACTORY-TEST MODE						
Turn-On Time for V _{OUT}	t _{VON}	C _L = 5pF, R _L = 5kΩ, Load Switch = OFF, DSR = LOW, Figure 1		6.3		ms
Timer Delay before Reset	t _{PHL}	C _L = 5pF, R _L = 5kΩ, Load Switch = ON, DSR = LOW, Figure 2		1.4		ms

NOTE 1: Input pins are nSR0, OFF, DSR and SYS_WAKE.

TYPICAL PERFORMANCE CHARACTERISTICS

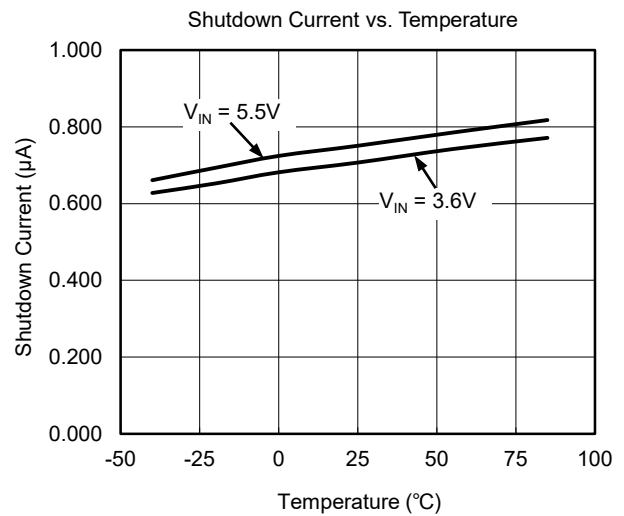
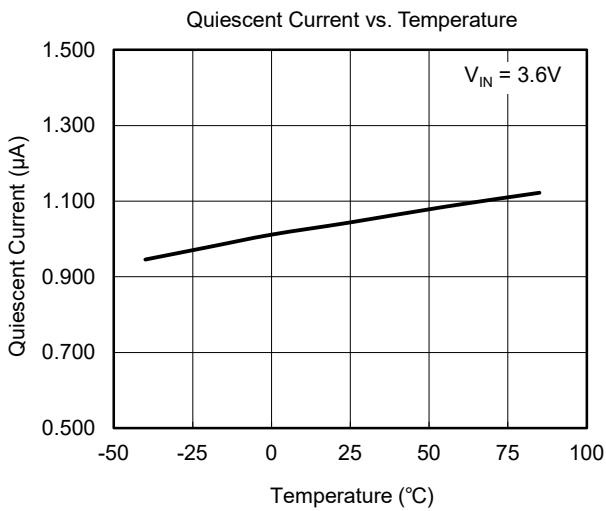
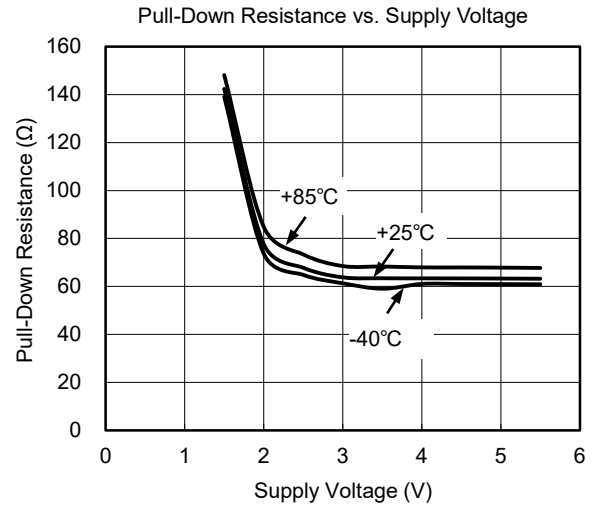
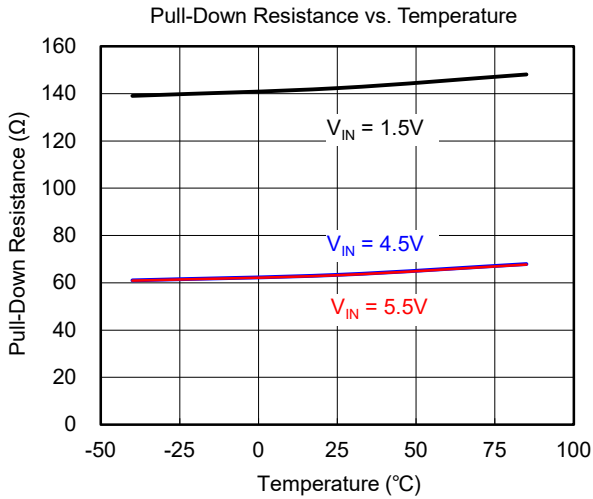
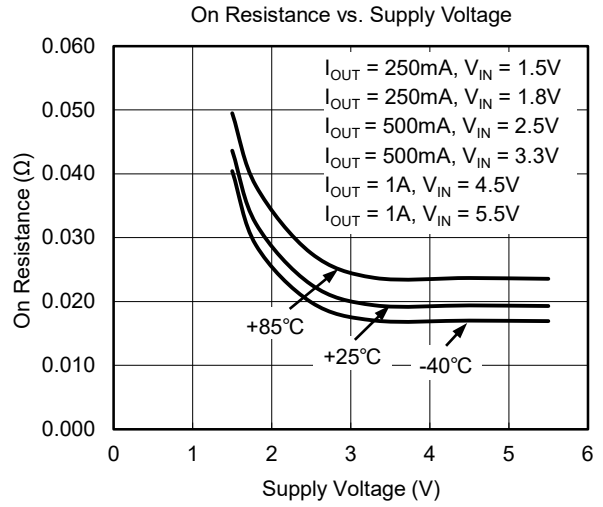
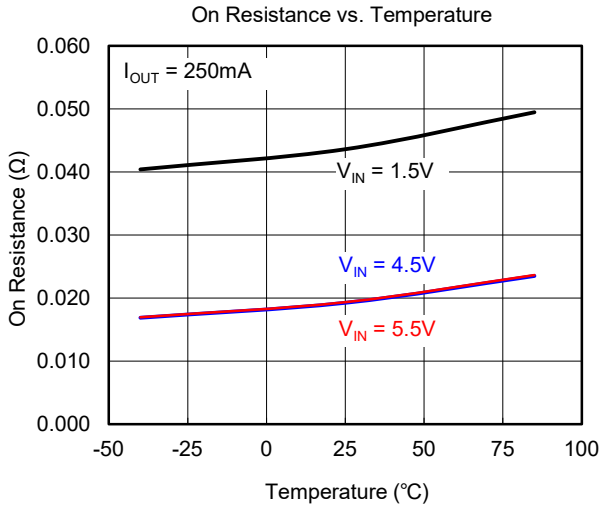

TYPICAL PERFORMANCE CHARACTERISTICS (continued)

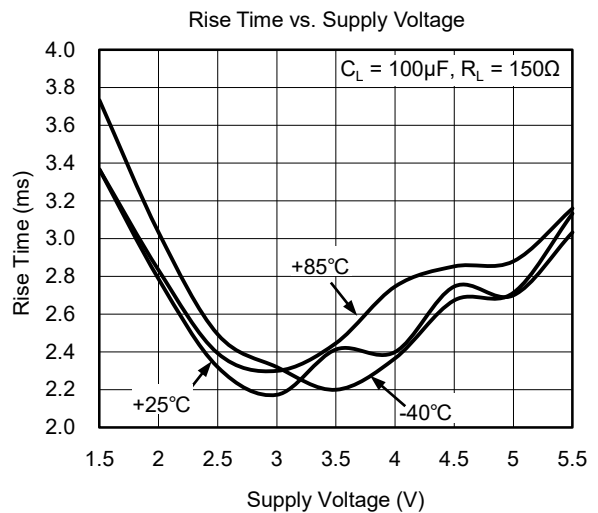
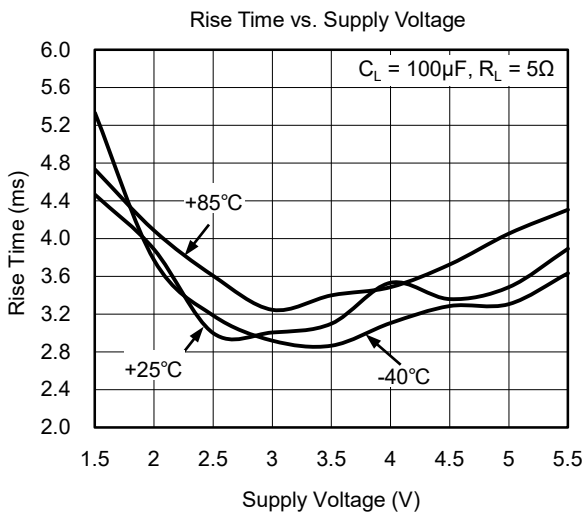
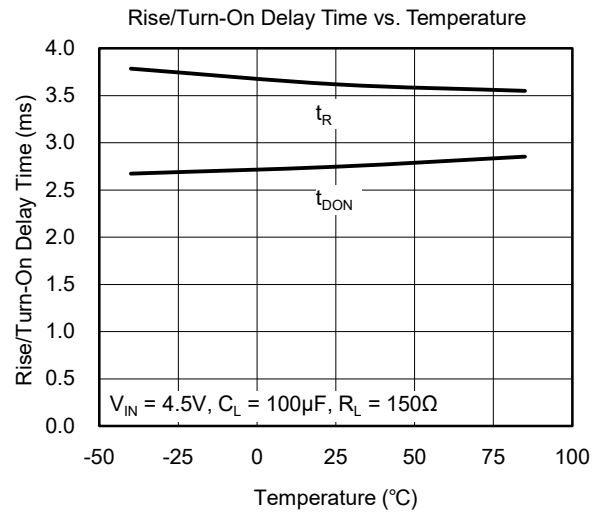
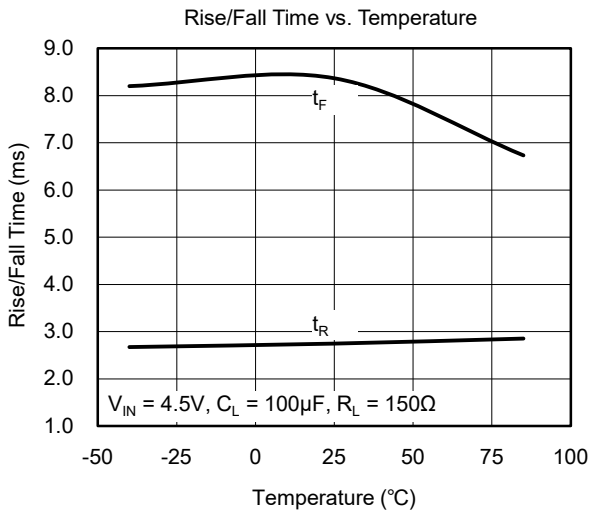
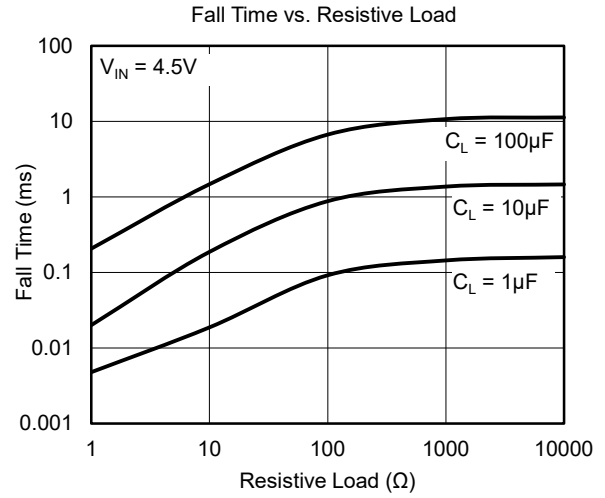
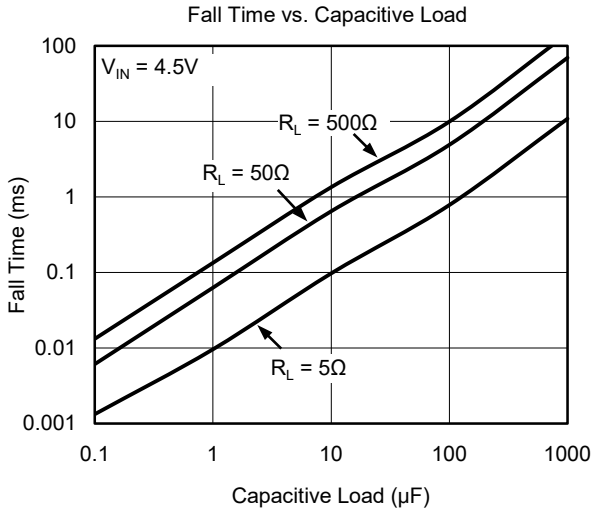

TYPICAL PERFORMANCE CHARACTERISTICS (continued)

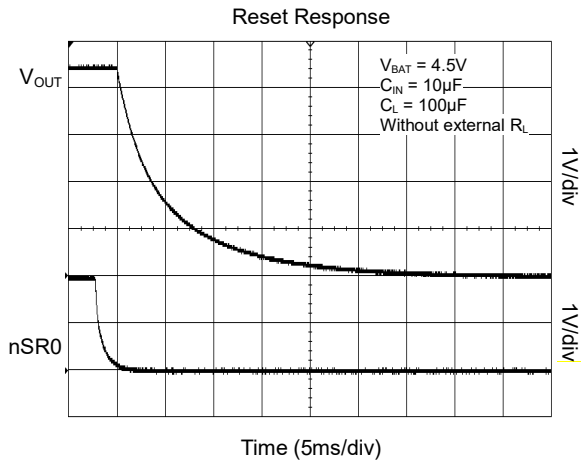

Figure 1. Power-On with nSR0

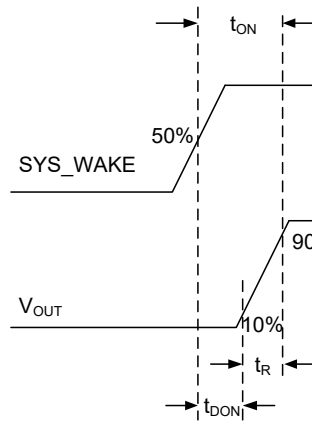
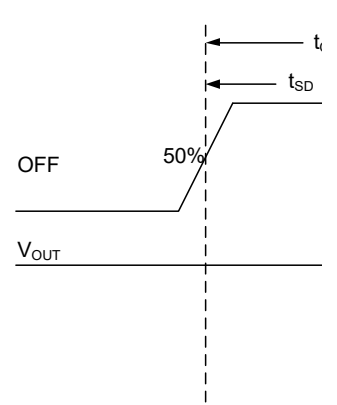

Figure 2. RESET Timing



TIMING DIAGRAMS

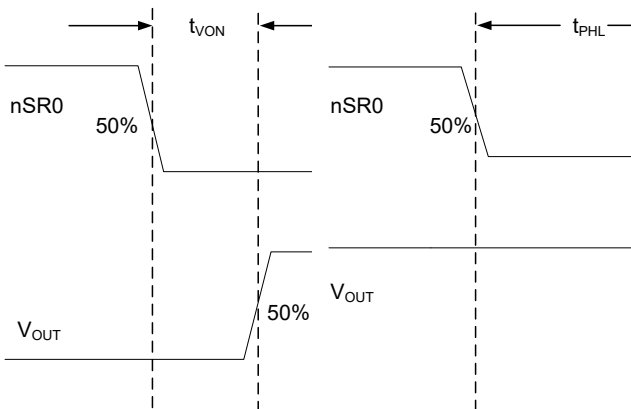

Figure 3. Timing Diagram (SYS_WAKE vs. V_{OUT})

Figure 4. Timing Diagram (OFF vs. V_{OUT})

REVISION HISTORY

NOTE: Page numbers for previous revisions may differ from page numbers in the current version.

MAY 2017 – REV.A.2 to REV.A.3

Change the Tape and Reel, 5000 to 3000 2

DECEMBER 2016 – REV.A.1 to REV.A.2

Change the Maximum Continuous Current 1, 2

OCTOBER 2016 – REV.A to REV.A.1

Change the OFF pin description 3, 10

Changes from Original (MAY 2016) to REV.A

PACKAGE OUTLINE DIMENSIONS

WLCSP-1.31×1.62-12B

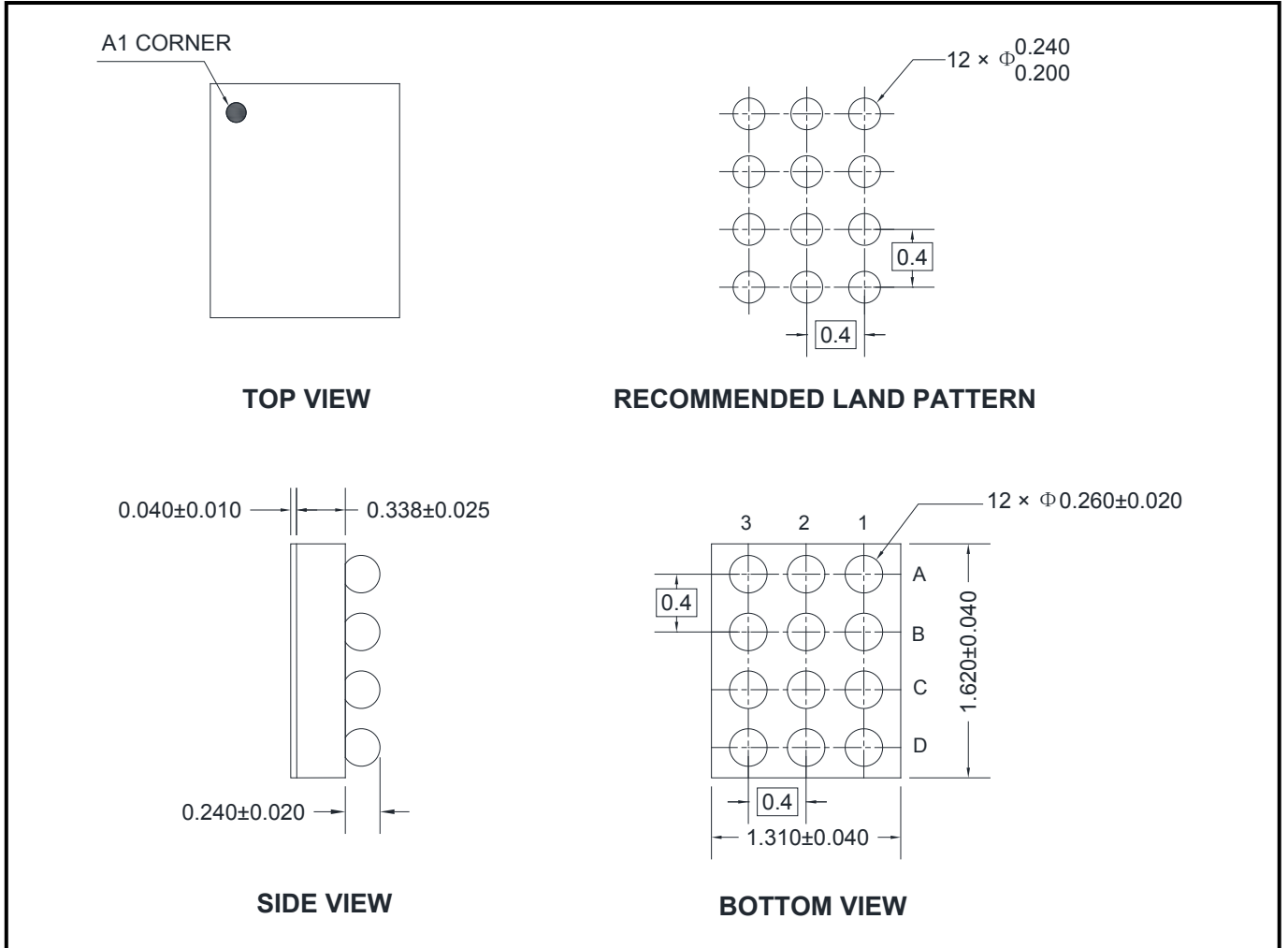

NOTE: All linear dimensions are in millimeters.

PACKAGE INFORMATION

TAPE AND REEL INFORMATION

REEL DIMENSIONS



TAPE DIMENSIONS



NOTE: The picture is only for reference. Please make the object as the standard.

KEY PARAMETER LIST OF TAPE AND REEL

Package Type	Reel Diameter	Reel Width W1 (mm)	A0 (mm)	B0 (mm)	K0 (mm)	P0 (mm)	P1 (mm)	P2 (mm)	W (mm)	Pin1 Quadrant
WLCSP-1.31×1.62-12B	7"	9.2	1.42	1.75	0.71	4.0	4.0	2.0	8.0	Q1

000001

PACKAGE INFORMATION

CARTON BOX DIMENSIONS



NOTE: The picture is only for reference. Please make the object as the standard.

KEY PARAMETER LIST OF CARTON BOX

Reel Type	Length (mm)	Width (mm)	Height (mm)	Pizza/Carton
7" (Option)	368	227	224	8
7"	442	410	224	18

DD0002