



SGM8264-2

High-Performance, Bipolar-Input, Ultra Low Noise HiFi Audio Headset Driver

GENERAL DESCRIPTION

The SGM8264-2 bipolar-input headset driver achieves very low $1.6\text{nV}/\sqrt{\text{Hz}}$ noise density with an ultra low distortion of 0.00002% at 1kHz. The SGM8264-2 offers rail-to-rail output swing to within 150mV of supply rails with a $2\text{k}\Omega$ load, which increases headroom and maximizes dynamic range. The device also has a high output drive capability of $\pm 110\text{mA}$.

The device operates over a wide supply range of 3.6V to 36V or $\pm 1.8\text{V}$ to $\pm 18\text{V}$, on only 4.1mA of supply current per amplifier. The SGM8264-2 is unity-gain stable and provides excellent dynamic behavior over a wide range of load conditions.

The SGM8264-2 is available in a Green SOIC-8 package. It operates over an ambient temperature range of -40°C to $+85^\circ\text{C}$.

FEATURES

- **Superior Sound Quality**
- **Low Offset Voltage: $\pm 350\mu\text{V}$ (MAX)**
- **Ultra Low Noise: $1.6\text{nV}/\sqrt{\text{Hz}}$ at 1kHz**
- **Ultra Low Distortion: 0.00002% at 1kHz**
- **High Slew Rate: $16\text{V}/\mu\text{s}$**
- **Gain-Bandwidth Product: 16MHz (G = +1)**
- **High Open-Loop Gain: 140dB**
- **Unity-Gain Stable**
- **Low Quiescent Current: 4.1mA/Amplifier**
- **Rail-to-Rail Output**
- **Support Single or Dual Power Supplies:
3.6V to 36V or $\pm 1.8\text{V}$ to $\pm 18\text{V}$**
- **-40°C to $+85^\circ\text{C}$ Operating Temperature Range**
- **Available in a Green SOIC-8 Package**

APPLICATIONS

Professional Audio Equipment
Analog and Digital Mixing Consoles
High-End A/V Receivers

PACKAGE/ORDERING INFORMATION

MODEL	PACKAGE DESCRIPTION	SPECIFIED TEMPERATURE RANGE	ORDERING NUMBER	PACKAGE MARKING	PACKING OPTION
SGM8264-2	SOIC-8	-40°C to +85°C	SGM8264-2YS8G/TR	SGM 82642YS8 XXXXX	Tape and Reel, 2500

MARKING INFORMATION

NOTE: XXXXX = Date Code and Vendor Code.

XXXXX

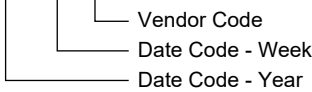

Green (RoHS & HSF): SG Micro Corp defines "Green" to mean Pb-Free (RoHS compatible) and free of halogen substances. If you have additional comments or questions, please contact your SGMICRO representative directly.

ABSOLUTE MAXIMUM RATINGS

Supply Voltage, +V _S to -V _S	40V
Input Voltage Range	(-V _S) - 0.3V to (+V _S) + 0.3V
Input Current (All pins except power supply pins).....	±10mA
Output Short-Circuit Current	±180mA
Junction Temperature	+150°C
Storage Temperature Range.....	-65°C to +150°C
Lead Temperature (Soldering, 10s)	+260°C
ESD Susceptibility	
HBM.....	8000V
MM.....	400V
CDM	1000V

RECOMMENDED OPERATING CONDITIONS

Operating Temperature Range	-40°C to +85°C
-----------------------------------	----------------

OVERSTRESS CAUTION

Stresses beyond those listed in Absolute Maximum Ratings may cause permanent damage to the device. Exposure to absolute maximum rating conditions for extended periods may affect reliability. Functional operation of the device at any conditions beyond those indicated in the Recommended Operating Conditions section is not implied.

ESD SENSITIVITY CAUTION

This integrated circuit can be damaged if ESD protections are not considered carefully. SGMICRO recommends that all integrated circuits be handled with appropriate precautions.

Failure to observe proper handling and installation procedures can cause damage. ESD damage can range from subtle performance degradation to complete device failure. Precision integrated circuits may be more susceptible to damage because even small parametric changes could cause the device not to meet the published specifications.

DISCLAIMER

SG Micro Corp reserves the right to make any change in circuit design, or specifications without prior notice.

PIN CONFIGURATION

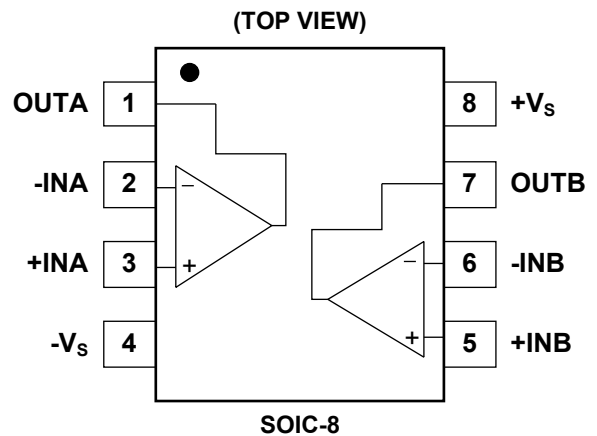

ELECTRICAL CHARACTERISTICS

(At $T_A = +25^\circ\text{C}$, $V_S = 4.5\text{V}$ to 36V or $V_S = \pm 2.25\text{V}$ to $\pm 18\text{V}$, $R_L = 2\text{k}\Omega$, $V_{CM} = V_{OUT} = V_S/2$, unless otherwise noted.)

PARAMETER	CONDITIONS	MIN	TYP	MAX	UNITS
Input Characteristics					
Input Offset Voltage (V_{OS})	$V_S = \pm 15\text{V}$		± 100	± 350	μV
	$-40^\circ\text{C} \leq T_A \leq +85^\circ\text{C}$			± 450	
Input Offset Voltage Drift ($\Delta V_{OS}/\Delta T$)	$V_S = \pm 15\text{V}$		1		$\mu\text{V}/^\circ\text{C}$
Input Bias Current (I_B)	$V_{CM} = V_{OUT} = V_S/2$		± 40	± 300	nA
	$-40^\circ\text{C} \leq T_A \leq +85^\circ\text{C}$			± 550	
Input Offset Current (I_{OS})	$V_{CM} = V_{OUT} = V_S/2$		± 25	± 175	nA
Input Common Mode Voltage Range (V_{CM})		$(-V_S) + 1.8$		$(+V_S) - 1.8$	V
Common Mode Rejection Ratio (CMRR)	$V_S = 4.5\text{V}$, $(-V_S) + 1.8\text{V} \leq V_{CM} \leq (+V_S) - 1.8\text{V}$	102	120		dB
	$-40^\circ\text{C} \leq T_A \leq +85^\circ\text{C}$	99			
	$V_S = 36\text{V}$, $(-V_S) + 1.8\text{V} \leq V_{CM} \leq (+V_S) - 1.8\text{V}$	122	135		
	$-40^\circ\text{C} \leq T_A \leq +85^\circ\text{C}$	108			
Open-Loop Voltage Gain (A_{OL})	$V_S = 4.5\text{V}$ to 36V , $(-V_S) + 0.2\text{V} \leq V_{OUT} \leq (+V_S) - 0.2\text{V}$, $R_L = 10\text{k}\Omega$	110	140		dB
	$-40^\circ\text{C} \leq T_A \leq +85^\circ\text{C}$	107			
	$V_S = 4.5\text{V}$ to 36V , $(-V_S) + 0.6\text{V} \leq V_{OUT} \leq (+V_S) - 0.6\text{V}$, $R_L = 2\text{k}\Omega$	112	140		
	$-40^\circ\text{C} \leq T_A \leq +85^\circ\text{C}$	109			
Input Impedance					
Differential			$32\text{k} \parallel 10$		$\Omega \parallel \text{pF}$
Common Mode			$10^9 \parallel 4$		$\Omega \parallel \text{pF}$
Output Characteristics					
Output Voltage Swing from Rail	$V_S = 4.5\text{V}$ to 36V , $R_L = 10\text{k}\Omega$		± 35	± 65	mV
	$V_S = 4.5\text{V}$ to 36V , $R_L = 2\text{k}\Omega$		± 150	± 260	
Output Short-Circuit Current (I_{SC})	$V_S = 10\text{V}$ to 36V		± 110		mA
Audio Performance					
Total Harmonic Distortion + Noise (THD+N)	$G = +1$, $V_{OUT} = 3V_{RMS}$, $f = 1\text{kHz}$		0.00002		%
			-134		dB
Intermodulation Distortion (IMD)	$G = +1$, $V_{OUT} = 3V_{RMS}$, SMPTE/DIN, Two-Tone, 4:1 (60Hz and 7kHz)		0.000015		%
			-136		dB
	$G = +1$, $V_{OUT} = 3V_{RMS}$, DIM 30, (3kHz square wave and 15kHz sine wave)		0.000032		%
			-130		dB
$G = +1$, $V_{OUT} = 3V_{RMS}$, CCIF Twin-Tone, (19kHz and 20kHz)		0.00013		%	
		-118		dB	
Frequency Response					
Gain-Bandwidth Product (GBP)	$G = +100$		45		MHz
	$G = +1$		16		
Slew Rate (SR)	$G = -1$		16		V/ μs
Full Power Bandwidth ⁽¹⁾	$V_{OUT} = 1V_{P-P}$		2		MHz
Overload Recovery Time	$G = -10$		500		ns
Channel Separation (Dual)	$f = 1\text{kHz}$		-140		dB

NOTE: 1. Full Power Bandwidth = $SR/(2\pi \times V_P)$, where SR = Slew Rate.

ELECTRICAL CHARACTERISTICS (continued)(At $T_A = +25^\circ\text{C}$, $V_S = 4.5\text{V}$ to 36V or $V_S = \pm 2.25\text{V}$ to $\pm 18\text{V}$, $R_L = 2\text{k}\Omega$, $V_{CM} = V_{OUT} = V_S/2$, unless otherwise noted.)

PARAMETER	CONDITIONS	MIN	TYP	MAX	UNITS
Noise Performance					
Input Voltage Noise	$f = 20\text{Hz}$ to 20kHz		1.7		μV_{P-P}
Input Voltage Noise Density (e_n)	$f = 10\text{Hz}$		5		$\text{nV}/\sqrt{\text{Hz}}$
	$f = 100\text{Hz}$		2		
	$f = 1\text{kHz}$		1.6		
Input Current Noise Density (i_n)	$f = 1\text{kHz}$		6		$\text{pA}/\sqrt{\text{Hz}}$
Power Supply					
Supply Voltage (V_S)		± 1.8		± 18	V
Specified Voltage (V_S)		± 2.25		± 18	V
Quiescent Current/Amplifier (I_Q)	$V_S = 3.6\text{V}$ to 36V , $I_{OUT} = 0$		4.1	5.5	mA
	$-40^\circ\text{C} \leq T_A \leq +85^\circ\text{C}$			5.8	
Power Supply Rejection Ratio (PSRR)	$V_S = \pm 1.8\text{V}$ to $\pm 18\text{V}$		0.1	0.5	$\mu\text{V}/\text{V}$
	$-40^\circ\text{C} \leq T_A \leq +85^\circ\text{C}$			1	

TYPICAL PERFORMANCE CHARACTERISTICS

At $T_A = +25^\circ\text{C}$, $V_S = \pm 15\text{V}$ and $R_L = 2\text{k}\Omega$, unless otherwise noted.

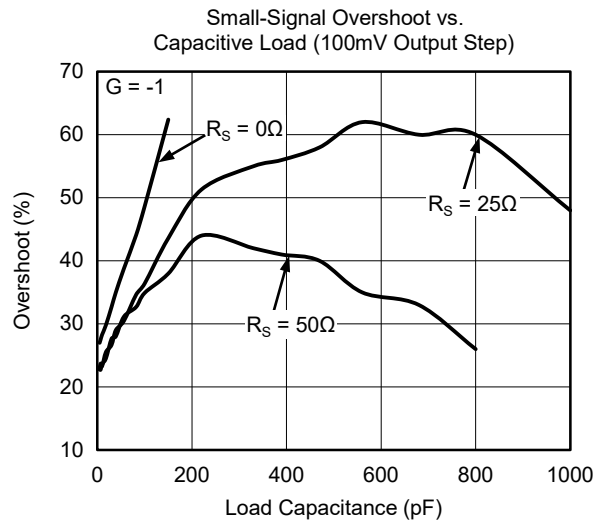
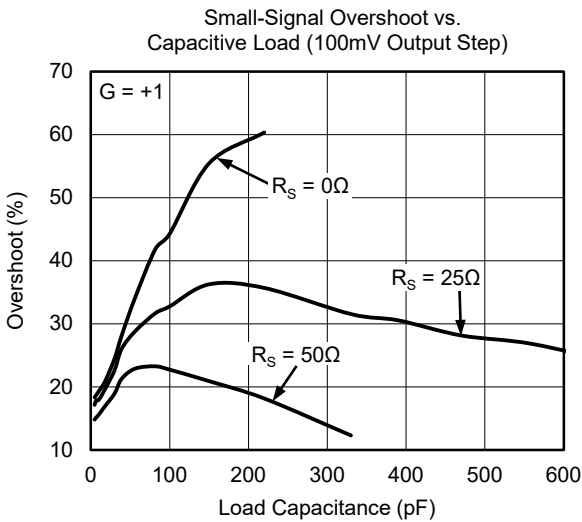
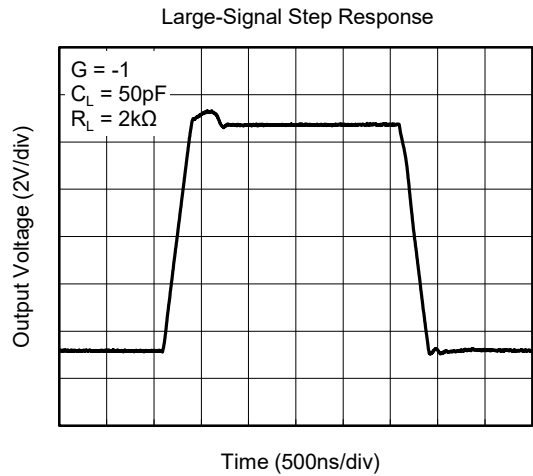
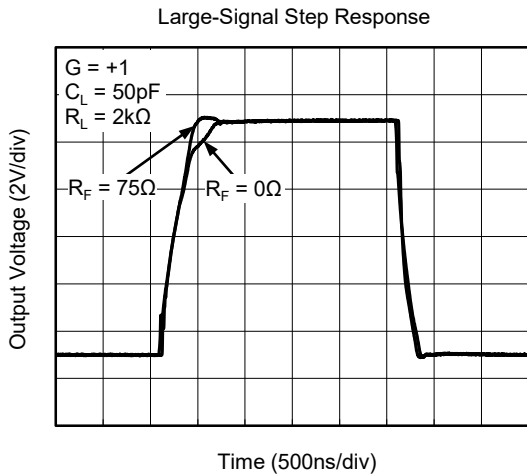
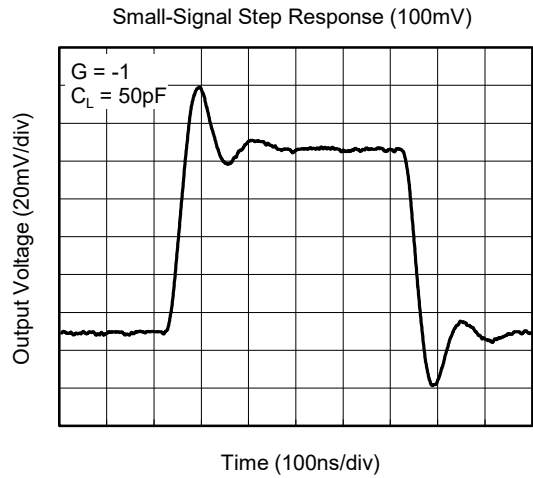
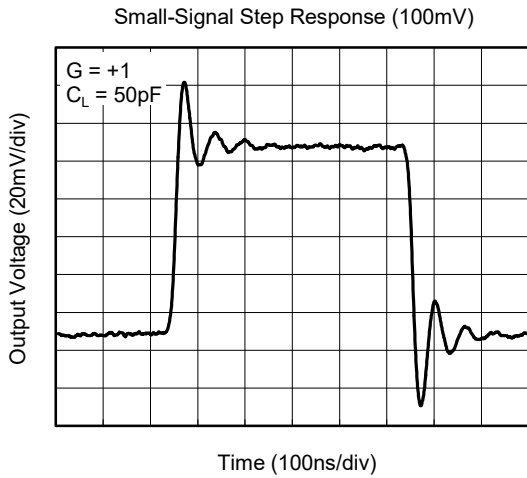

TYPICAL PERFORMANCE CHARACTERISTICS (continued)

At $T_A = +25^\circ\text{C}$, $V_S = \pm 15\text{V}$ and $R_L = 2\text{k}\Omega$, unless otherwise noted.

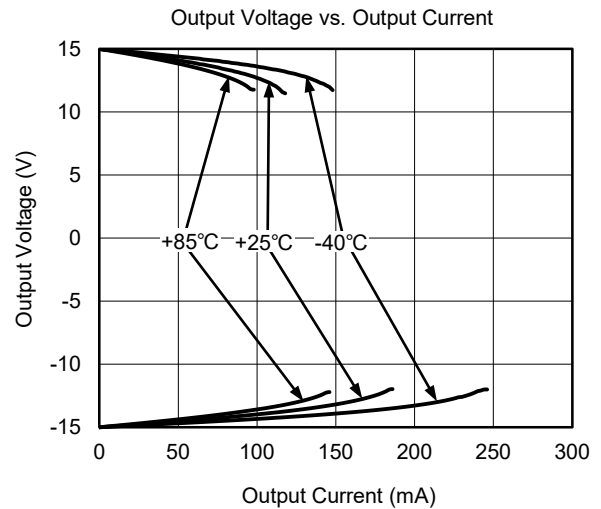
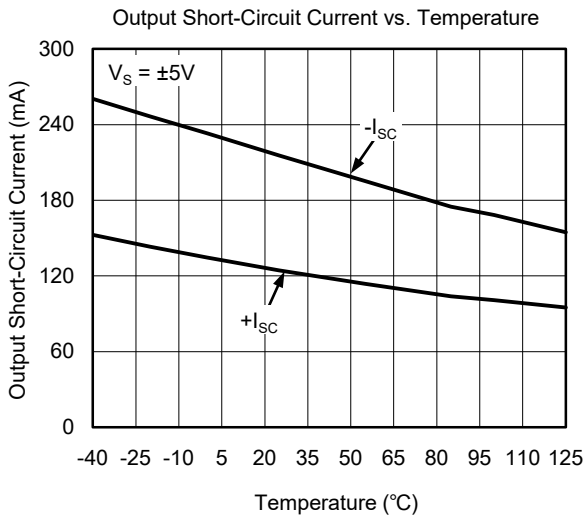
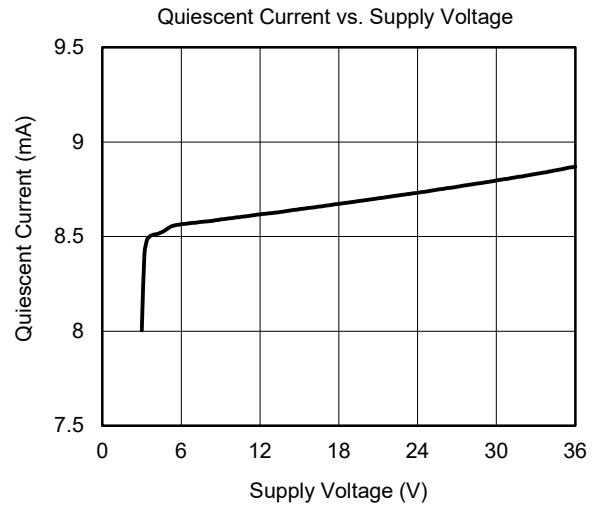
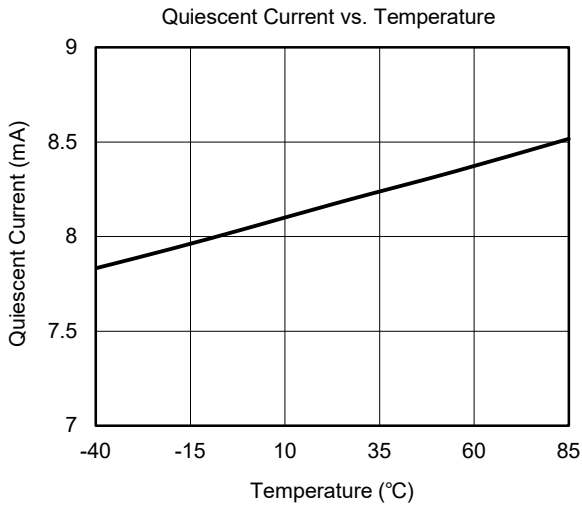
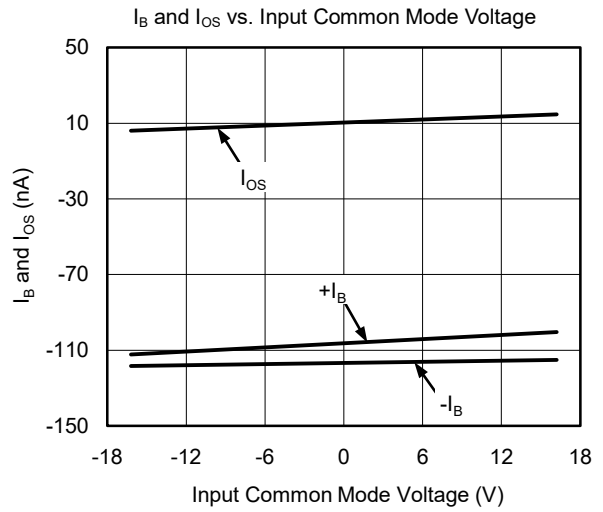
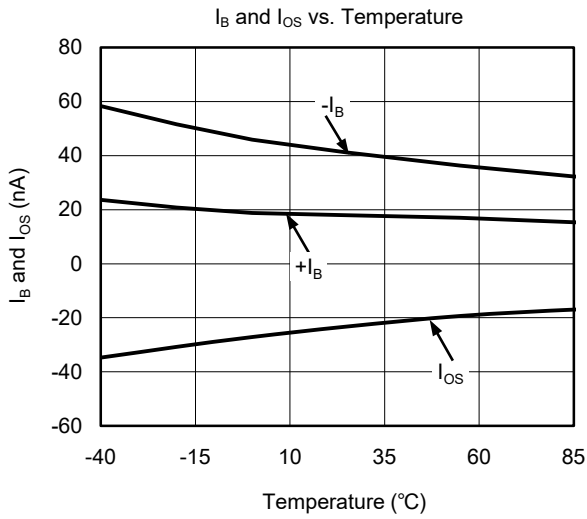

TYPICAL PERFORMANCE CHARACTERISTICS (continued)

At $T_A = +25^\circ\text{C}$, $V_S = \pm 15\text{V}$ and $R_L = 2\text{k}\Omega$, unless otherwise noted.

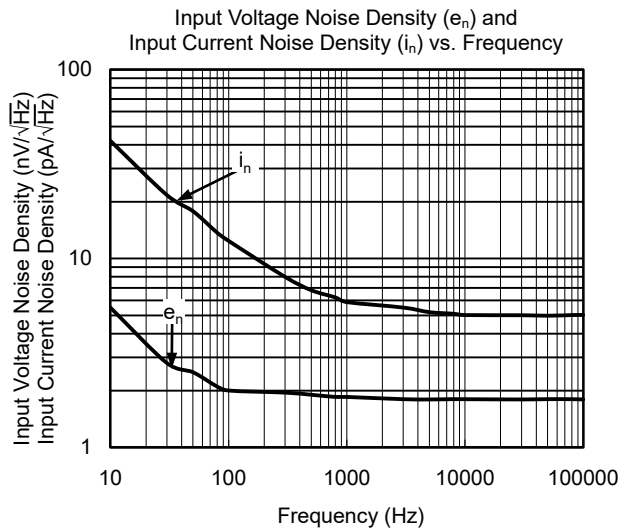
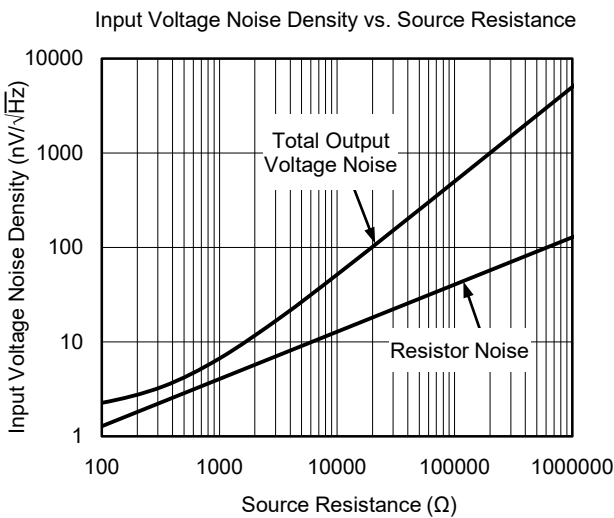
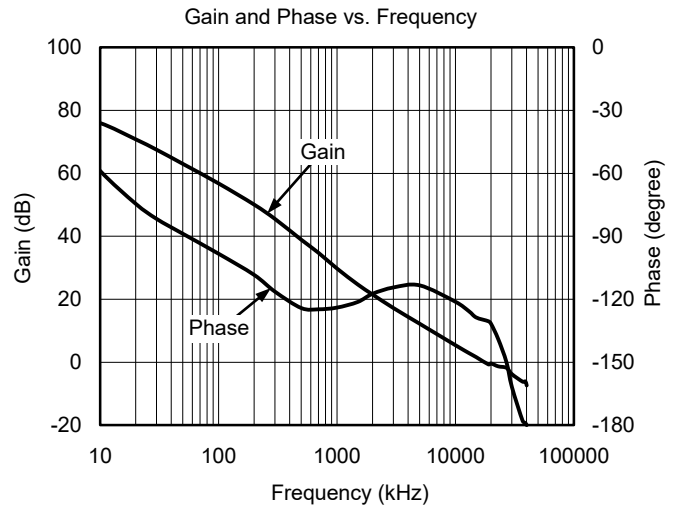
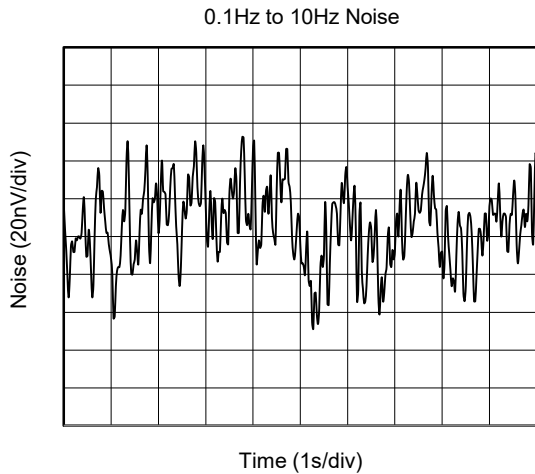
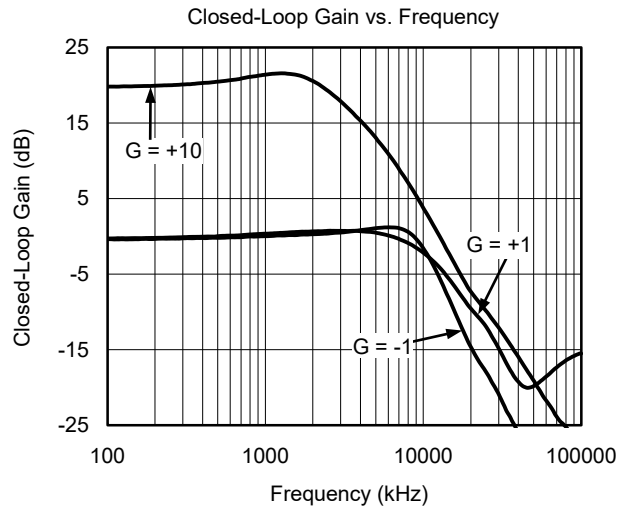
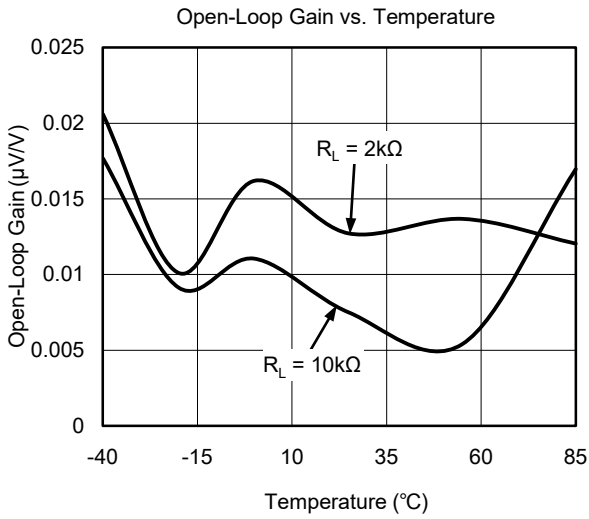

TYPICAL PERFORMANCE CHARACTERISTICS (continued)

At $T_A = +25^\circ\text{C}$, $V_S = \pm 15\text{V}$ and $R_L = 2\text{k}\Omega$, unless otherwise noted.

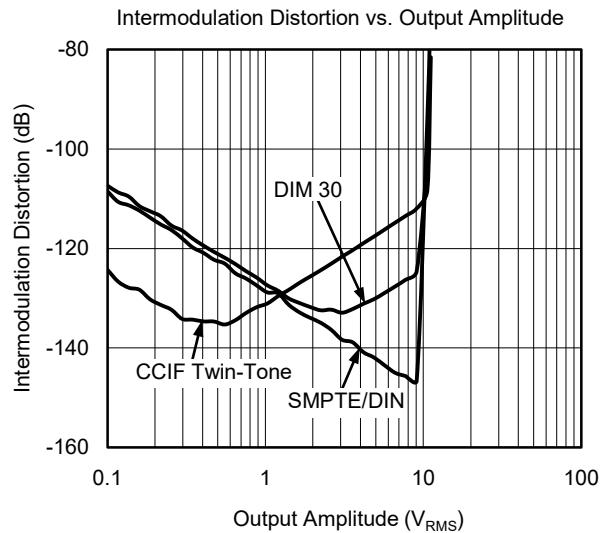
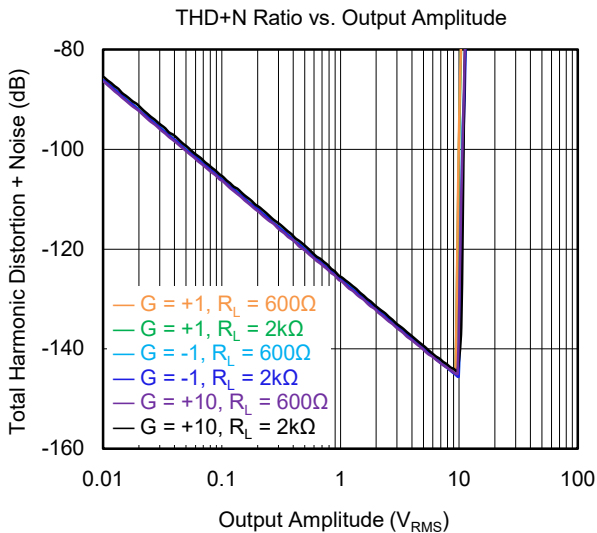
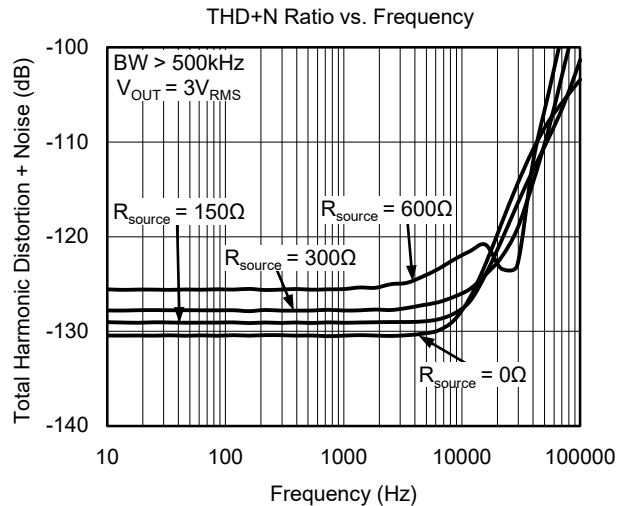
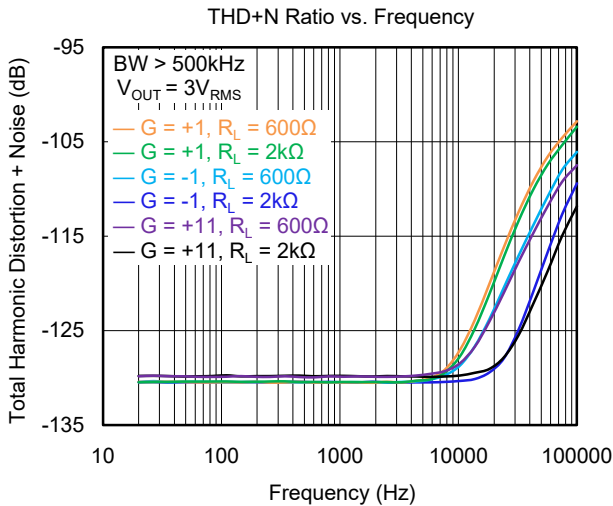
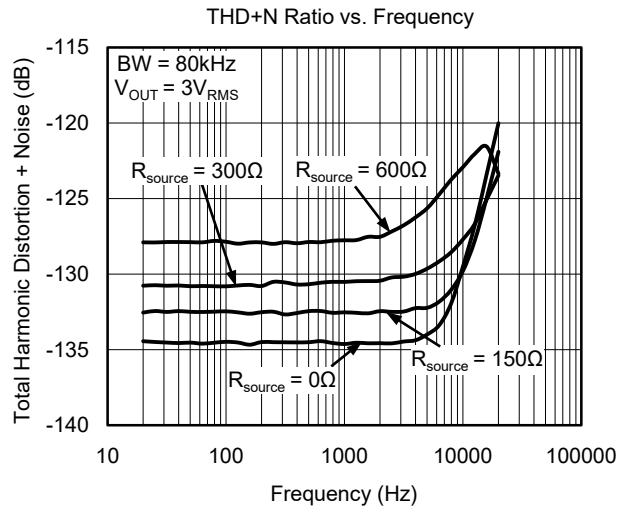
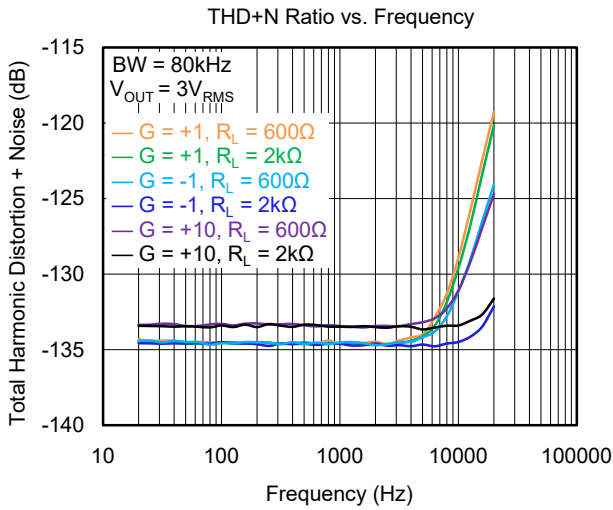

TYPICAL PERFORMANCE CHARACTERISTICS (continued)

At $T_A = +25^\circ\text{C}$, $V_S = \pm 15\text{V}$ and $R_L = 2\text{k}\Omega$, unless otherwise noted.

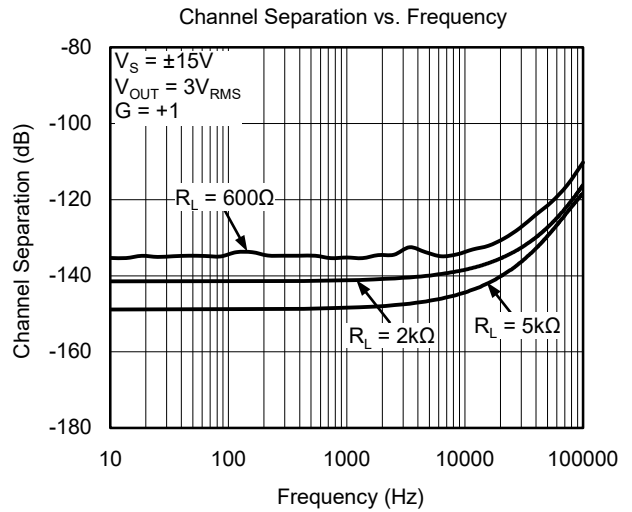
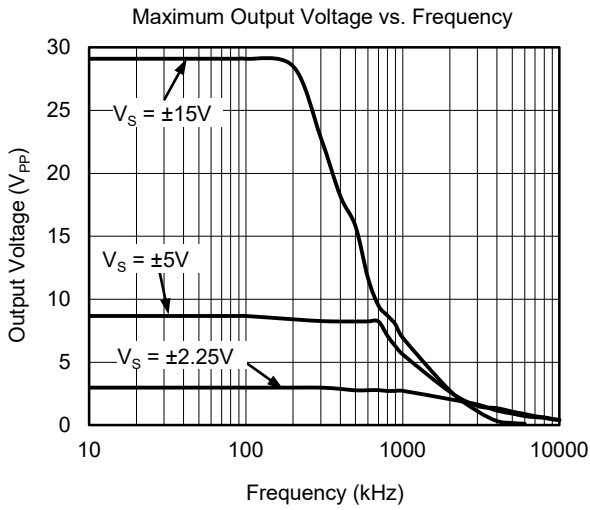
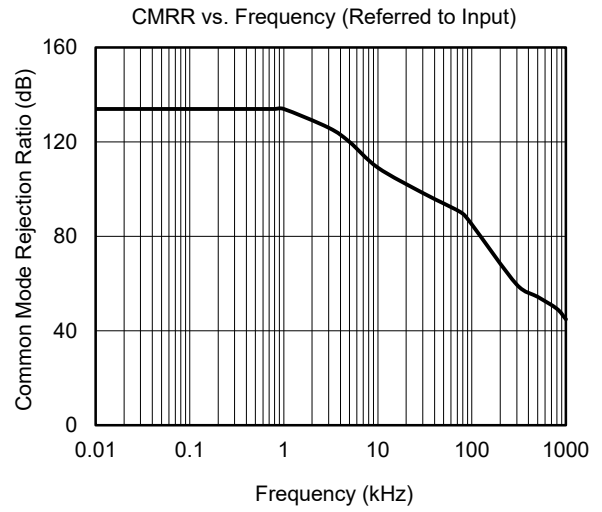
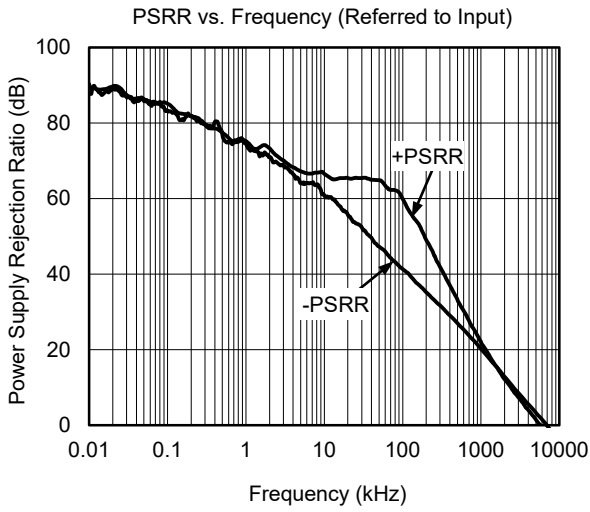

APPLICATION INFORMATION

The SGM8264-2 is a unity-gain stable, precision driver with very low noise; the device is also free from output phase reversal. Applications with noisy or high-impedance power supplies require decoupling capacitors close to the device power supply pins. In most cases, 0.1µF capacitors are adequate.

Operating Voltage

The SGM8264-2 driver operates from 3.6V to 36V or ±2.25V to ±18V supplies while maintaining excellent performance. However, some applications do not require equal positive and negative output voltage swing. With the SGM8264-2, power supply voltages do not need to be equal. For example, the positive supply could be set to +25V with the negative supply at -5V. In all cases, the input common mode voltage must be maintained within the specified range. In addition, key parameters are assured over the specified temperature range of T_A = -40°C to +85°C.

Input Protection

The input terminals of the SGM8264-2 are protected from excessive differential voltage with back-to-back diodes, as Figure 1 illustrates. In most circuit applications, the input protection circuitry has no consequence. However, in low-gain or G = +1 circuits, fast ramping input signals can forward bias these diodes because the output of the amplifier cannot respond rapidly enough to the input ramp. If the input signal is fast enough to create this forward bias condition, the input signal current must be limited to 10mA or less. If the input signal current is not inherently limited, an input series resistor (R_i) and/or a feedback resistor (R_f) can be used to limit the signal input current. This input series resistor degrades the low-noise performance of the SGM8264-2 and is examined in the following Noise Performance section. Figure 1 shows an example configuration when both current-limit input and feedback resistors are used.

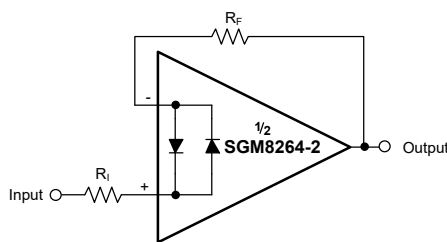

Figure 1. Input Current Limit

Noise Performance

Equation 1 shows the total circuit noise for varying source impedances with the operational amplifier in a unity-gain configuration (Figure 2, no feedback resistor network, and therefore no additional noise contributions).

The SGM8264-2 (GBP = 16MHz, G = +1) is shown with total circuit noise calculated. The operational amplifier itself contributes both a voltage noise component and a current noise component. The voltage noise is commonly modeled as a time-varying component of the offset voltage. The current noise is modeled as the time-varying component of the input bias current and reacts with the source resistance to create a voltage component of noise. Therefore, the lowest noise operational amplifier for a given application depends on the source impedance. For low source impedance, current noise is negligible, and voltage noise generally dominates. The low voltage noise of the SGM8264-2 driver makes it a good choice for use in applications where the source impedance is less than 1kΩ.

The following equation shows the calculation of the total circuit noise:

$$E_o^2 = e_n^2 + (i_n R_s)^2 + 4kTR_s \tag{1}$$

Where e_n = voltage noise, i_n = current noise, R_s = source impedance, k = Boltzmann’s constant = 1.38 × 10⁻²³ J/K, T = temperature in degrees Kelvin (K).

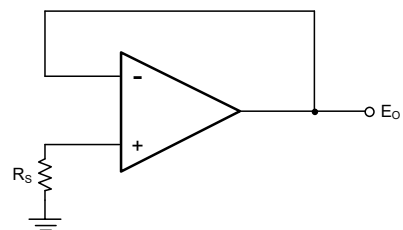

Figure 2. Unity-Gain Buffer Configuration

APPLICATION INFORMATION (continued)

Basic Noise Calculations

Design of low-noise operational amplifier circuits requires careful consideration of a variety of possible noise contributors: noise from the signal source, noise generated in the operational amplifier and noise from the feedback network resistors. The total noise of the circuit is the root-sum-square combination of all noise components.

The resistive portion of the source impedance produces thermal noise proportional to the square root of the resistance. The source impedance is usually fixed; consequently, select the operational amplifier and the

feedback resistors to minimize the respective contributions to the total noise.

Figure 3 illustrates both inverting and non-inverting operational amplifier circuit configurations with gain. In circuit configurations with gain, the feedback network resistors also contribute noise.

The current noise of the operational amplifier reacts with the feedback resistors to create additional noise components. The feedback resistor values can generally be chosen to make these noise sources negligible. The equations for total noise are shown for both configurations.

Noise in Non-Inverting Gain Configuration

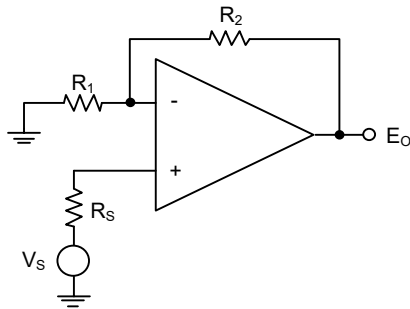

Noise at the output:

$$E_o^2 = \left[1 + \frac{R_2}{R_1} \right]^2 e_n^2 + e_1^2 + e_2^2 + (i_n R_2)^2 + e_s^2 + (i_n R_s)^2 \left[1 + \frac{R_2}{R_1} \right]^2$$

Where $e_s = \sqrt{4kTR_s} \times \left[1 + \frac{R_2}{R_1} \right]$ = thermal noise of R_s

$$e_1 = \sqrt{4kTR_1} \times \left[\frac{R_2}{R_1} \right] = \text{thermal noise of } R_1$$

$$e_2 = \sqrt{4kTR_2} = \text{thermal noise of } R_2$$

Noise in Inverting Gain Configuration

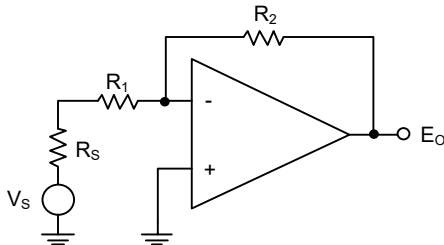

Noise at the output:

$$E_o^2 = \left[1 + \frac{R_2}{R_1 + R_s} \right]^2 e_n^2 + e_1^2 + e_2^2 + (i_n R_2)^2 + e_s^2$$

Where $e_s = \sqrt{4kTR_s} \times \left[\frac{R_2}{R_1 + R_s} \right]$ = thermal noise of R_s

$$e_1 = \sqrt{4kTR_1} \times \left[\frac{R_2}{R_1 + R_s} \right] = \text{thermal noise of } R_1$$

$$e_2 = \sqrt{4kTR_2} = \text{thermal noise of } R_2$$

NOTE: For the SGM8264-2 driver at 1kHz, $e_n = 1.6nV/\sqrt{Hz}$ and $i_n = 6pA/\sqrt{Hz}$.

Figure 3. Noise Calculation in Gain Configurations

APPLICATION INFORMATION (continued)

Total Harmonic Distortion Measurements

The SGM8264-2 driver has excellent distortion characteristics. THD + noise is below 0.00015% ($G = +1$, $V_{OUT} = 3V_{RMS}$, $BW = 80kHz$) throughout the audio frequency range, 20Hz to 20kHz, with a 2kΩ load.

The distortion produced by SGM8264-2 driver is below the measurement limit of many commercially available distortion analyzers. However, a special test circuit (such as Figure 4 shows) can be used to extend the measurement capabilities.

Operational amplifier distortion can be considered an internal error source that can be referred to the input. Figure 4 shows a circuit that causes the operational amplifier distortion to be 101 times (or approximately 40dB) greater than that normally produced by the operational amplifier. The addition of R_3 to the otherwise standard non-inverting amplifier configuration alters the feedback factor or noise gain of the circuit. The closed-loop gain is unchanged, but the feedback available for error correction is reduced by a factor of 101, thus extending the resolution by 101. Note that the input signal and load applied to the operational amplifier are the same as with conventional feedback without R_3 . The value of R_3 should be kept small to minimize its effect on the distortion measurements.

Validity of this technique can be verified by duplicating measurements at high gain and/or high frequency where the distortion is within the measurement capability of the test equipment. Measurements for this datasheet were made with an Audio Precision System Two distortion/noise analyzer, which greatly simplifies such repetitive measurements. The measurement technique can, however, be performed with manual distortion measurement instruments.

Capacitive Loads

The dynamic characteristics of the SGM8264-2 have been optimized for commonly encountered gains, loads, and operating conditions. The combination of low closed-loop gain and high capacitive loads decreases the phase margin of the amplifier and can lead to gain peaking or oscillations. As a result, heavier capacitive loads must be isolated from the output. The simplest way to achieve this isolation is to add a small resistor (R_S equal to 50Ω, for example) in series with the output.

Power Dissipation

SGM8264-2 driver is capable of driving 2kΩ loads with a power supply voltage up to ±18V. Internal power dissipation increases when operating at high supply voltages. Copper leadframe construction used in the SGM8264-2 driver improves heat dissipation compared to conventional materials. Circuit board layout can also help minimize junction temperature rise. Wide copper traces help dissipate the heat by acting as an additional heat sink. Temperature rise can be further minimized by soldering the device to the circuit board rather than using a socket.

Electrical Overstress

Designers often ask questions about the capability of an operational amplifier to withstand electrical overstress. These questions tend to focus on the device inputs, but may involve the supply voltage pins or even the output pin. Each of these different pin functions has electrical stress limits determined by the voltage breakdown characteristics of the particular semiconductor fabrication process and specific circuits connected to the pin. Additionally, internal electrostatic discharge (ESD) protection is built into these circuits to protect them from accidental ESD events both before and during product assembly.

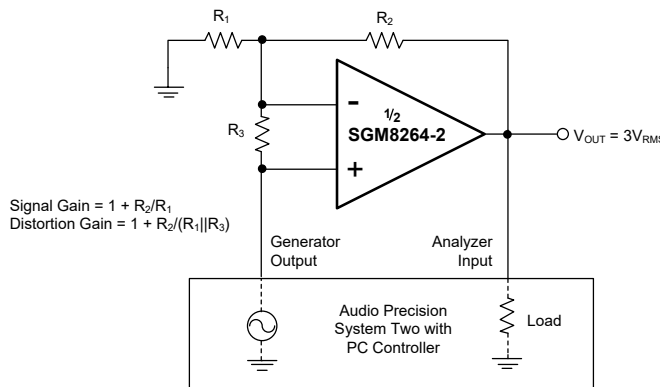

Signal Gain = $1 + R_2/R_1$
Distortion Gain = $1 + R_2/(R_1 || R_3)$

SIG. Gain	DIST. Gain	R ₁	R ₂	R ₃
1	101	∞	1kΩ	10Ω
-1	101	4.99kΩ	4.99kΩ	49.9Ω
+10	110	549Ω	4.99kΩ	49.9Ω

Figure 4. Distortion Test Circuit

APPLICATION CIRCUIT

Figure 5 shows how to use the SGM8264-2 as an amplifier for professional audio headphones. The circuit

shows the left side stereo channel. An identical circuit is used to drive the right side stereo channel.

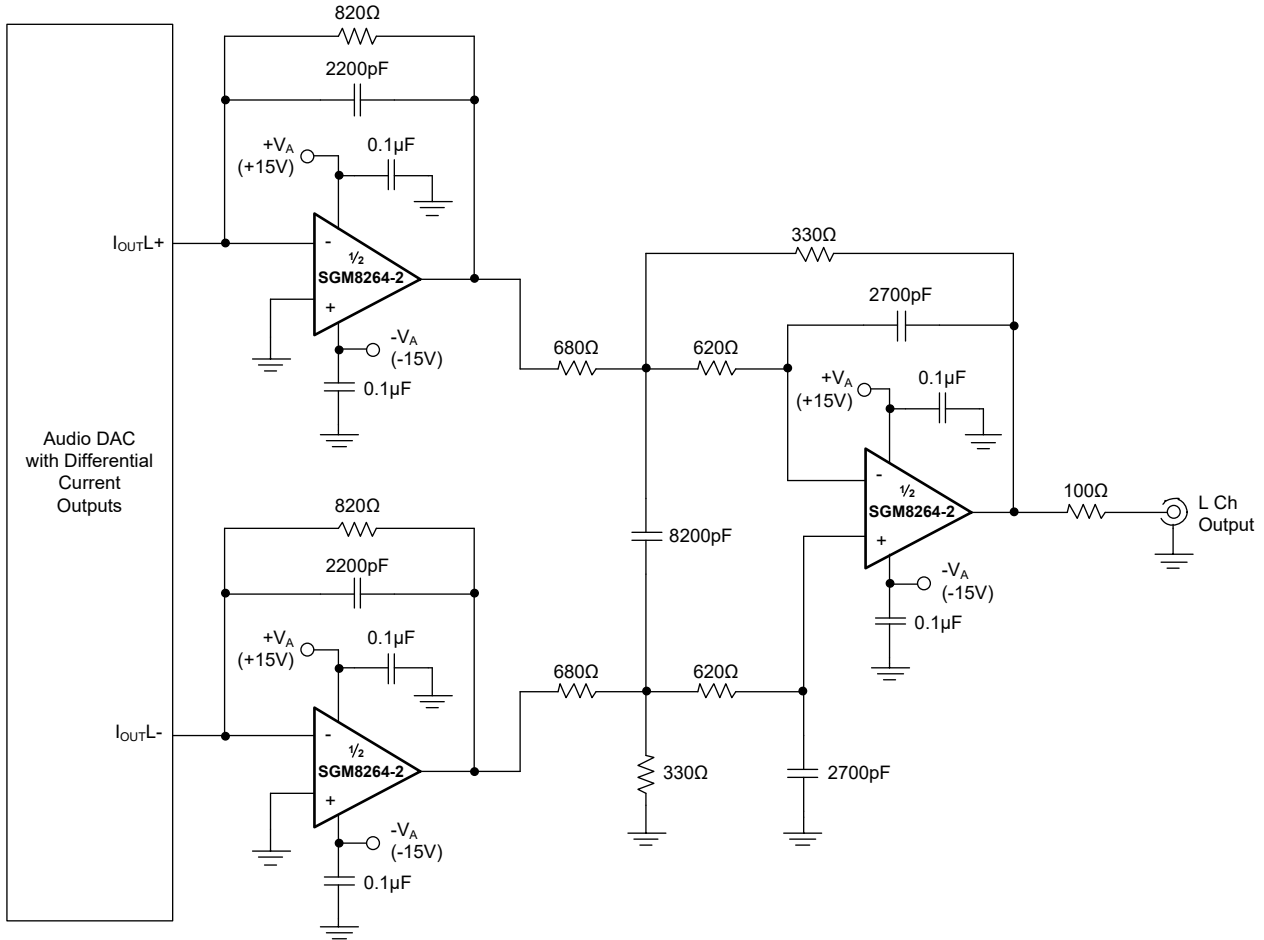

Figure 5. Audio DAC Post Filter (I/V Converter and Low-Pass Filter)

REVISION HISTORY

NOTE: Page numbers for previous revisions may differ from page numbers in the current version.

Changes from Original (DECEMBER 2017) to REV.A	Page
Changed from product preview to production data.....	All

PACKAGE OUTLINE DIMENSIONS

SOIC-8

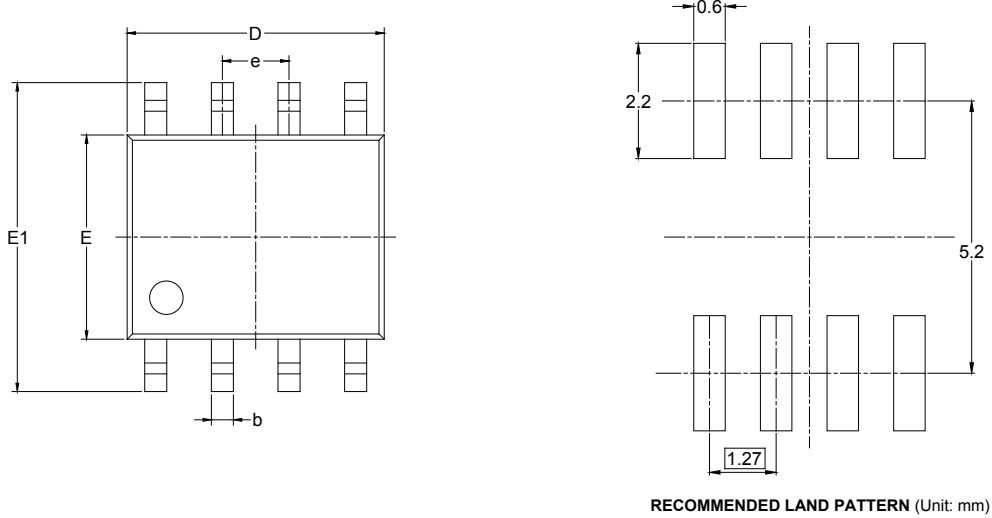

Symbol	Dimensions In Millimeters		Dimensions In Inches	
	MIN	MAX	MIN	MAX
A	1.350	1.750	0.053	0.069
A1	0.100	0.250	0.004	0.010
A2	1.350	1.550	0.053	0.061
b	0.330	0.510	0.013	0.020
c	0.170	0.250	0.006	0.010
D	4.700	5.100	0.185	0.200
E	3.800	4.000	0.150	0.157
E1	5.800	6.200	0.228	0.244
e	1.27 BSC		0.050 BSC	
L	0.400	1.270	0.016	0.050
θ	0°	8°	0°	8°

PACKAGE INFORMATION

TAPE AND REEL INFORMATION

REEL DIMENSIONS

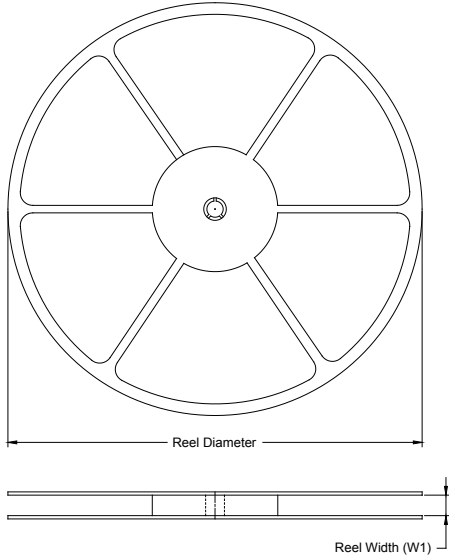

TAPE DIMENSIONS

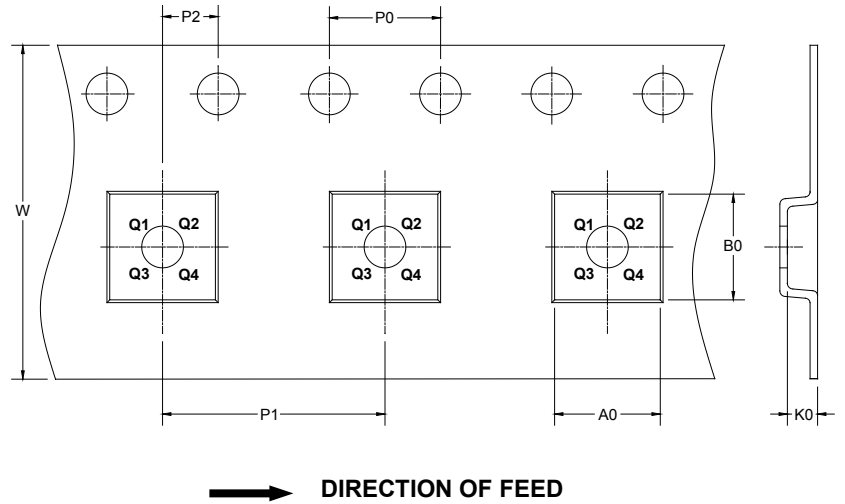

NOTE: The picture is only for reference. Please make the object as the standard.

KEY PARAMETER LIST OF TAPE AND REEL

Package Type	Reel Diameter	Reel Width W1 (mm)	A0 (mm)	B0 (mm)	K0 (mm)	P0 (mm)	P1 (mm)	P2 (mm)	W (mm)	Pin1 Quadrant
SOIC-8	13"	12.4	6.40	5.40	2.10	4.0	8.0	2.0	12.0	Q1

000001

PACKAGE INFORMATION

CARTON BOX DIMENSIONS



NOTE: The picture is only for reference. Please make the object as the standard.

KEY PARAMETER LIST OF CARTON BOX

Reel Type	Length (mm)	Width (mm)	Height (mm)	Pizza/Carton
13"	386	280	370	5

DD0002