

### GENERAL DESCRIPTION

The SGM2211S is a low noise, high PSRR, fast transient response and low dropout voltage linear regulator. It provides 500mA output current capability. The operating input voltage range is from 3.8V to 20V.

Other features include logic-controlled shutdown mode, short-circuit current limit and thermal shutdown protection. The SGM2211S has automatic discharge function to quickly discharge  $V_{OUT}$  in the disabled status.

The SGM2211S is available in a Green SOT-23-5 package. It operates over an operating temperature range of -40°C to +125°C.

### APPLICATIONS

- Instrumentation
- Precision ADC and DAC
- Precision Amplifiers in Industrial Equipment
- Low Noise VCO
- RF System
- Medical Equipment

### FEATURES

- **Input Voltage Range: 3.8V to 20V**
- **Fixed Output of 3.3V**
- **500mA Output Current**
- **Output Voltage Accuracy:  $\pm 1\%$  at +25°C**
- **Low Quiescent Current: 64 $\mu$ A (TYP)**
- **Low Dropout Voltage:**  
400mV (TYP) at 500mA,  $V_{OUT} = 3.3V$
- **Low Noise: 10.5 $\mu$ V<sub>RMS</sub> at  $V_{OUT} = 3.3V$**
- **High PSRR ( $V_{IN} = V_{OUT(NOM)} + 1V$ ):**
  - ◆ 92dB (TYP) at 1kHz
  - ◆ 76dB (TYP) at 10kHz
  - ◆ 57dB (TYP) at 100kHz
  - ◆ 42dB (TYP) at 1MHz
- **Current Limiting and Thermal Protection**
- **Excellent Load and Line Transient Responses**
- **With Output Automatic Discharge**
- **Stable with Small Case Size Ceramic Capacitors**
- **Shutdown Supply Current: 4 $\mu$ A (TYP)**
- **Reverse Current Protection when  $V_{OUT} > V_{IN}$**
- **Programmable Precision Enable**
- **-40°C to +125°C Operating Temperature Range**
- **Available in a Green SOT-23-5 Package**

### TYPICAL APPLICATION

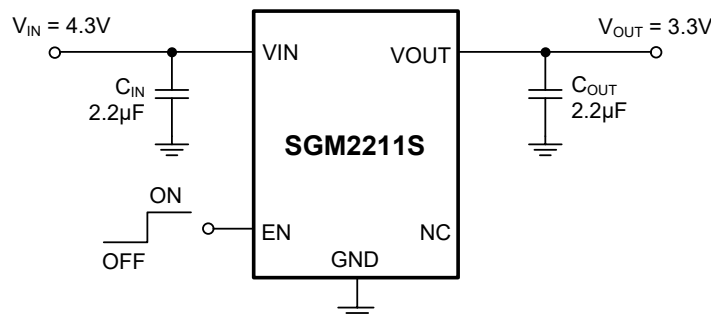

Figure 1. Typical Application Circuit

**PACKAGE/ORDERING INFORMATION**

MODEL	PACKAGE DESCRIPTION	SPECIFIED TEMPERATURE RANGE	ORDERING NUMBER	PACKAGE MARKING	PACKING OPTION
SGM2211S-3.3	SOT-23-5	-40°C to +125°C	SGM2211S-3.3XN5G/TR	093XX	Tape and Reel, 3000

**MARKING INFORMATION**

NOTE: XX = Date Code.

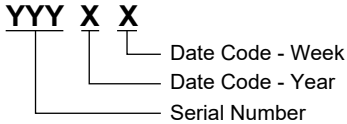

Green (RoHS & HSF): SG Micro Corp defines "Green" to mean Pb-Free (RoHS compatible) and free of halogen substances. If you have additional comments or questions, please contact your SGMICRO representative directly.

**ABSOLUTE MAXIMUM RATINGS**

VIN to GND.....	-0.3V to 24V
VOUT to GND.....	-0.3V to 13V
EN to GND.....	-0.3V to 24V
Package Thermal Resistance	
SOT-23-5, $\theta_{JA}$ .....	148°C/W
SOT-23-5, $\theta_{JB}$ .....	32.4°C/W
SOT-23-5, $\theta_{JC}$ .....	73.1°C/W
Junction Temperature.....	+150°C
Storage Temperature Range.....	-65°C to +150°C
Lead Temperature (Soldering, 10s).....	+260°C
ESD Susceptibility	
HBM.....	2500V
CDM.....	1000V

**RECOMMENDED OPERATING CONDITIONS**

Input Voltage Range.....	3.8V to 20V
Input Effective Capacitance, $C_{IN}$ .....	1.5 $\mu$ F (MIN)
Output Effective Capacitance, $C_{OUT}$ .....	1.5 $\mu$ F to 10 $\mu$ F
Operating Junction Temperature Range.....	-40°C to +125°C

**OVERSTRESS CAUTION**

Stresses beyond those listed in Absolute Maximum Ratings may cause permanent damage to the device. Exposure to absolute maximum rating conditions for extended periods may affect reliability. Functional operation of the device at any conditions beyond those indicated in the Recommended Operating Conditions section is not implied.

**ESD SENSITIVITY CAUTION**

This integrated circuit can be damaged if ESD protections are not considered carefully. SGMICRO recommends that all integrated circuits be handled with appropriate precautions. Failure to observe proper handling and installation procedures can cause damage. ESD damage can range from subtle performance degradation to complete device failure. Precision integrated circuits may be more susceptible to damage because even small parametric changes could cause the device not to meet the published specifications.

**DISCLAIMER**

SG Micro Corp reserves the right to make any change in circuit design, or specifications without prior notice.

**PIN CONFIGURATION**

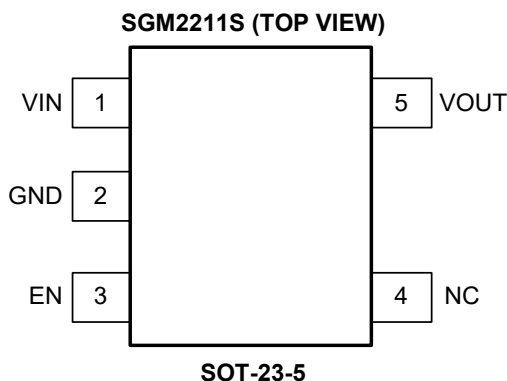

**PIN DESCRIPTION**

PIN	NAME	FUNCTION
1	VIN	Input Voltage Supply Pin. It is recommended to use a 2.2µF or larger ceramic capacitor from VIN pin to ground to get good power supply decoupling. This ceramic capacitor should be placed as close as possible to VIN pin.
2	GND	Ground.
3	EN	Enable Pin. Drive EN high to turn on the regulator. Drive EN low to turn off the regulator.
4	NC	No Connection.
5	VOUT	Regulator Output Pin. It is recommended to use a ceramic capacitor with effective capacitance in the range of 1.5µF to 10µF to ensure stability. This ceramic capacitor should be placed as close as possible to VOUT pin.

# PACKAGE INFORMATION

## PACKAGE OUTLINE DIMENSIONS

### SOT-23-5

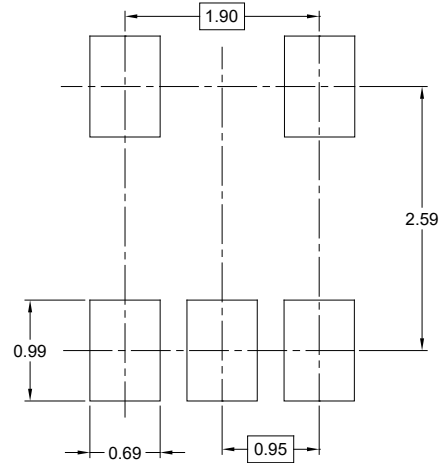
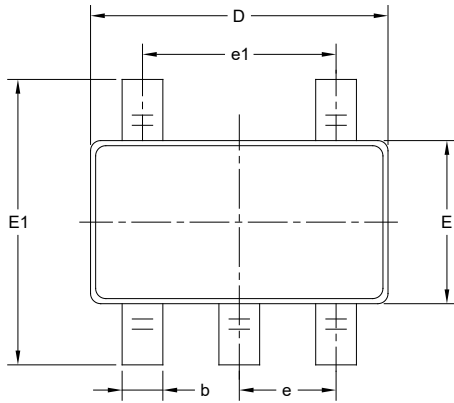

RECOMMENDED LAND PATTERN (Unit: mm)

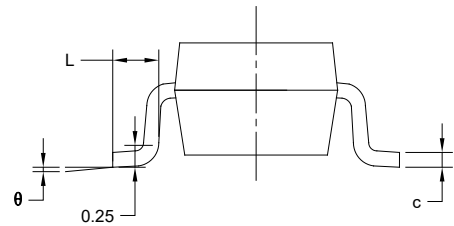
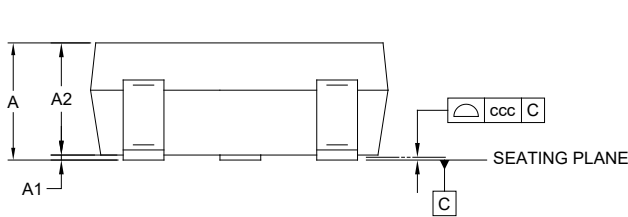

Symbol	Dimensions In Millimeters		
	MIN	MOD	MAX
A	-	-	1.450
A1	0.000	-	0.150
A2	0.900	-	1.300
b	0.300	-	0.500
c	0.080	-	0.220
D	2.750	-	3.050
E	1.450	-	1.750
E1	2.600	-	3.000
e	0.950 BSC		
e1	1.900 BSC		
L	0.300	-	0.600
$\theta$	0°	-	8°
ccc	0.100		

NOTES:

1. This drawing is subject to change without notice.
2. The dimensions do not include mold flashes, protrusions or gate burrs.
3. Reference JEDEC MO-178.

# PACKAGE INFORMATION

## TAPE AND REEL INFORMATION

### REEL DIMENSIONS



### TAPE DIMENSIONS



NOTE: The picture is only for reference. Please make the object as the standard.

### KEY PARAMETER LIST OF TAPE AND REEL

Package Type	Reel Diameter	Reel Width W1 (mm)	A0 (mm)	B0 (mm)	K0 (mm)	P0 (mm)	P1 (mm)	P2 (mm)	W (mm)	Pin1 Quadrant
SOT-23-5	7"	9.5	3.20	3.20	1.40	4.0	4.0	2.0	8.0	Q3

000001

# PACKAGE INFORMATION

## CARTON BOX DIMENSIONS



NOTE: The picture is only for reference. Please make the object as the standard.

## KEY PARAMETER LIST OF CARTON BOX

Reel Type	Length (mm)	Width (mm)	Height (mm)	Pizza/Carton
7" (Option)	368	227	224	8
7"	442	410	224	18

DD0002