



SGM8417A-1

24V, 1.5A Peak Output Current Rail-to-Rail I/O Operational Amplifier

GENERAL DESCRIPTION

The SGM8417A-1 is a single, high slew rate, low power operational amplifier optimized for high voltage systems. The device can operate on single or dual power supply. It supports rail-to-rail input and output operation.

The SGM8417A-1 features 10mV maximum offset voltage, 1.5A peak output current, and 74V/ μ s high slew rate. The combination of characteristics makes the device suitable for TFT-LCDs.

The SGM8417A-1 is available in a Green TDFN-3 \times 3-8L package. It is specified over the -40°C to +85°C temperature range.

FEATURES

- **Peak Output Current: 1.5A**
- **High Slew Rate: 74V/ μ s**
- **Unity-Gain Stable**
- **Rail-to-Rail Input and Output**
- **Supply Voltage Range: 4.5V to 24V**
- **-40°C to +85°C Operating Temperature Range**
- **Available in a Green TDFN-3 \times 3-8L Package**

APPLICATIONS

TFT-LCD Panels
LCD TVs
Monitors
Laptops

PACKAGE/ORDERING INFORMATION

MODEL	PACKAGE DESCRIPTION	SPECIFIED TEMPERATURE RANGE	ORDERING NUMBER	PACKAGE MARKING	PACKING OPTION
SGM8417A-1	TDFN-3x3-8L	-40°C to +85°C	SGM8417A-1YTDB8G/TR	SGM G5XDB XXXXX	Tape and Reel, 4000

MARKING INFORMATION

NOTE: XXXXX = Date Code, Trace Code and Vendor Code.

XXXXX

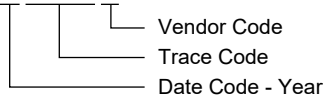

Green (RoHS & HSF): SG Micro Corp defines "Green" to mean Pb-Free (RoHS compatible) and free of halogen substances. If you have additional comments or questions, please contact your SGMICRO representative directly.

ABSOLUTE MAXIMUM RATINGS

- Supply Voltage, +V_S to -V_S..... -0.3V to 28V
- Input/Output Voltage to -V_S..... -0.3V to (+V_S) + 0.3V
- +IN to -IN ±5V
- Duration of Output Short to +V_S or -V_S..... 30min
- Package Thermal Resistance
- TDFN-3x3-8L, θ_{JA}..... 84°C/W
- Junction Temperature..... +150°C
- Storage Temperature Range -65°C to +150°C
- Lead Temperature (Soldering, 10s)..... +260°C
- ESD Susceptibility
- HBM..... 8000V
- CDM 1000V

RECOMMENDED OPERATING CONDITIONS

- Supply Voltage Range 4.5V to 24V
- Operating Temperature Range -40°C to +85°C

OVERSTRESS CAUTION

Stresses beyond those listed in Absolute Maximum Ratings may cause permanent damage to the device. Exposure to absolute maximum rating conditions for extended periods may affect reliability. Functional operation of the device at any conditions beyond those indicated in the Recommended Operating Conditions section is not implied.

ESD SENSITIVITY CAUTION

This integrated circuit can be damaged if ESD protections are not considered carefully. SGMICRO recommends that all integrated circuits be handled with appropriate precautions. Failure to observe proper handling and installation procedures can cause damage. ESD damage can range from subtle performance degradation to complete device failure. Precision integrated circuits may be more susceptible to damage because even small parametric changes could cause the device not to meet the published specifications.

DISCLAIMER

SG Micro Corp reserves the right to make any change in circuit design, or specifications without prior notice.

PIN CONFIGURATION

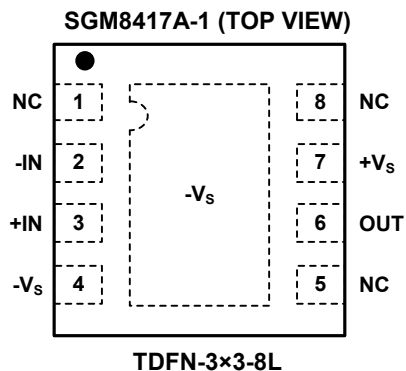

FUNCTIONAL BLOCK DIAGRAM

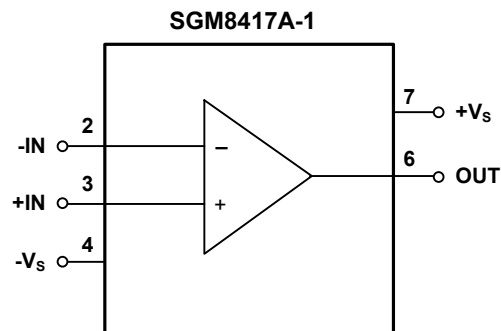

NOTE: Connect thermal die pad to $-V_s$. Connect it to $-V_s$ plane to maximize thermal performance.

ELECTRICAL CHARACTERISTICS

($+V_S = 4.5V$ to $24V$, $-V_S = 0V$, $+V_{IN} = V_{OUT} = +V_S/2$, Full = $-40^\circ C$ to $+85^\circ C$, typical values are at $T_A = +25^\circ C$, unless otherwise noted.)

PARAMETER	SYMBOL	CONDITIONS	TEMP	MIN	TYP	MAX	UNITS
Input Characteristics							
Input Offset Voltage	V_{OS}	$V_{CM} = +V_S/2$	$+25^\circ C$		2.4	10	mV
			Full			12	
Input Offset Voltage Drift	$\Delta V_{OS}/\Delta T$	$V_{CM} = +V_S/2$			3.6		$\mu V/^\circ C$
Input Bias Current	I_B	$V_{CM} = +V_S/2$	$+25^\circ C$		0.3	1.5	nA
			Full			60	
Load Regulation	ΔV_{LOAD}	$I_{OUT} = 0mA$ to $-80mA$	Full		0.01	0.08	mV/mA
		$I_{OUT} = 0mA$ to $80mA$	Full	-0.08	-0.01		
Input Common Mode Voltage Range	V_{CM}		Full	-0.1		$(+V_S) + 0.1$	V
Common Mode Rejection Ratio	CMRR	$+V_S = 16V$, $-0.1V \leq V_{CM} \leq (+V_S) + 0.1V$	$+25^\circ C$	60	72		dB
			Full	57			
Open-Loop Voltage Gain	A_{OL}	$+V_S = 16V$, $0.5V \leq V_{CM} \leq (+V_S) - 0.5V$	$+25^\circ C$	92	120		dB
			Full	88			
Output Characteristics							
Low Output Voltage Swing from Rail	V_{OL}	$I_L = -50mA$	Full		0.13	0.22	V
High Output Voltage Swing from Rail	V_{OH}	$I_L = 50mA$	Full	$(+V_S) - 0.33$	$(+V_S) - 0.22$		V
Transient Peak Output Current	I_{PK}	$+V_S = 24V$	$+25^\circ C$		± 1.5		A
Continuous Output Current ⁽¹⁾	I_{OUT}	$+V_S = 24V$, V_{OUT} reaches within $-3.5V$ from $+V_S$ and $+3.5V$ from $-V_S$	$+25^\circ C$		± 400		mA
Power Supply							
Supply Voltage Range	V_S		Full	4.5		24	V
Power Supply Rejection Ratio	PSRR	$+V_S = 4.5V$ to $24V$, $V_{CM} = 2.25V$	$+25^\circ C$	87	94		dB
			Full	84			
Quiescent Current	I_Q	No load	Full		3.3	5.5	mA
Dynamic Performance							
Slew Rate	SR	4V step, $C_L = 50pF$, $R_L = 10k\Omega$, 20% to 80%, $A_V = 1$	$+25^\circ C$		74		V/ μs
Settling Time to $\pm 0.1\%$	t_s	$A_V = 1$, $V_{OUT} = 2V$ step, $R_L = 10k\Omega$, $C_L = 10pF$	$+25^\circ C$		134		ns
-3dB Bandwidth	BW	$R_L = 10k\Omega$, $C_L = 10pF$	$+25^\circ C$		75		MHz
Gain-Bandwidth Product	GBP	$R_L = 10k\Omega$, $C_L = 10pF$	$+25^\circ C$		26		MHz
Phase Margin	PM	$R_L = 10k\Omega$, $C_L = 10pF$	$+25^\circ C$		36		$^\circ$
Noise Performance							
Input Voltage Noise Density	e_n	$f = 1kHz$	$+25^\circ C$		118		nV/ \sqrt{Hz}
Thermal Protection							
Thermal Shutdown Temperature	T_{SHDN}				140		$^\circ C$
Thermal Shutdown Hysteresis	ΔT_{SHDN}				20		$^\circ C$

NOTE:

1. The result is determined by the power consumption and the heat dissipation of the package, while the power consumption is mainly determined by the $|(\pm V_S) - V_{OUT}| \times I_{OUT}$. See the Thermal Consideration section for more information.

TYPICAL PERFORMANCE CHARACTERISTICS

At $T_A = +25^\circ\text{C}$, $+V_S = 16\text{V}$, $-V_S = 0\text{V}$, unless otherwise specified.

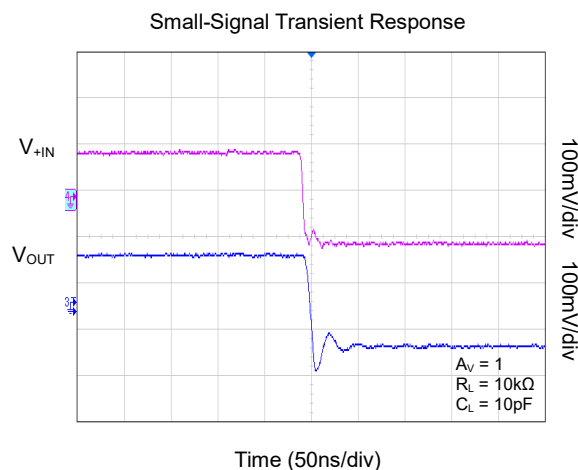
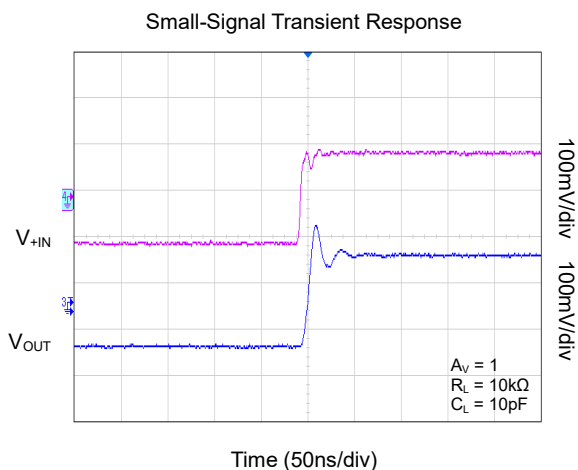
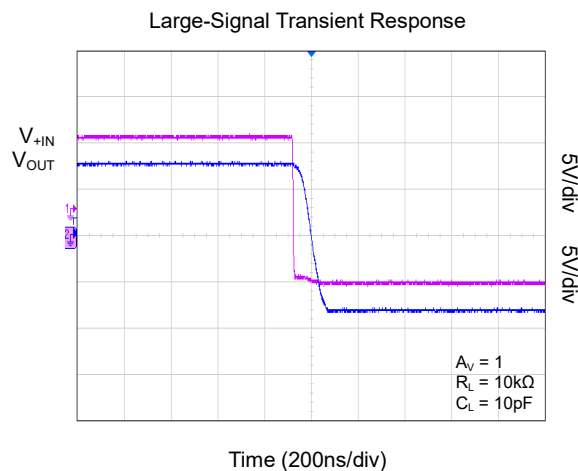
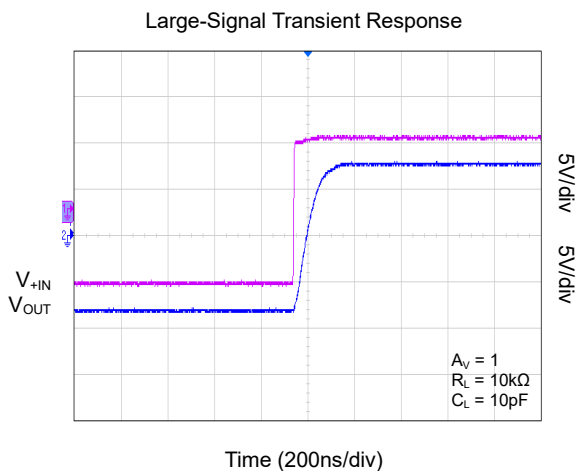

APPLICATION INFORMATION

The SGM8417A-1 is specifically designed to drive high current load. The device supports rail-to-rail input and output operation, and consumes low quiescent current. It can also provide a high slew rate. The combination of characteristics makes SGM8417A-1 suitable for LCD applications.

Operating Voltage

The SGM8417A-1 is guaranteed to operate from 4.5V to 24V, and the operation is extremely stable over the whole specified range of the temperature. The output voltage swing can be closer to the supply rail by reducing the load current.

LCD Panel Application

The SGM8417A-1 can provide optimal performance in LCD V_{COM} buffer. It features $\pm 1.5A$ transient peak source/sink current.

Output Current Limit

The SGM8417A-1 can drive $\pm 1.5A$ transient peak output current. The device has a $\pm 1.5A$ (TYP) current limit, which is accomplished with the characteristics of the internal metal interconnects. Maximum reliability is maintained if the output continuous current never exceeds $\pm 400mA$.

Short-Circuit Protection

The output can be shorted to $\pm V_S$ for 60 seconds and the supply-to-output differential voltage must be less than $|2V|$, else the SGM8417A-1 may be damaged.

Thermal Consideration

When operating the device, the users need to make sure that the junction temperature is below the absolute maximum one. The junction temperature is increasing because the power dissipation is higher than before. And a lot of possibilities can cause the thermal considerations, such as the width of trace in PCB, the package of the device, the gap between ambient and junction temperature and rate of environmental airflow.

When the die temperature exceeds the threshold value of thermal shutdown, the output will be in high impedance state and it will remain in this state until the die temperature decreases to $+120^\circ C$.

The following equation indicates the calculation of power dissipation:

$$P_{D(MAX)} = (T_{J(MAX)} - T_A) / \theta_{JA} \quad (1)$$

where:

$T_{J(MAX)}$ = Maximum junction temperature.

T_A = Ambient temperature.

θ_{JA} = Junction to ambient thermal resistance.

It is recommended that the junction temperature should not exceed $+125^\circ C$ for normal operation. The parameter of ambient thermal resistance is determined by the width of trace in PCB layout.

In addition, the ambient temperature and thermal resistance will affect the power dissipation of SGM8417A-1.

Layout

For the circuits with high power path, a good PCB design is essential. It is recommended to use the following layout method to improve the performance of SGM8417A-1 at most.

- ◆ The power component should be close enough to SGM8417A-1 for better performance. Also, if the high current is necessary, the corresponding trace in PCB should be short and wide.
- ◆ For some applications such as filtering, a series resistor is necessary to be added at the output of the device.
- ◆ Choosing a suitable bypass capacitor can enhance the stability when driving the loads with high transient. For single-supply operation, the bypass capacitor should be placed as close to $+V_S$ pin as possible. For dual-supply operation, both $+V_S$ and $-V_S$ supplies should be bypassed to ground with separate $0.1\mu F$ ceramic capacitors. Using a $10\mu F$ tantalum capacitor is a good choice to improve the operating stability of the device when driving high transient load.
- ◆ A $0.1\mu F$ capacitor should be connected with +IN pin to GND for better operation of SGM8417A-1 and the distance between this capacitor and +IN pin should be minimized.
- ◆ It is recommended to connect exposed pad to $-V_S$ directly in the PCB.

REVISION HISTORY

NOTE: Page numbers for previous revisions may differ from page numbers in the current version.

JUNE 2023 – REV.A to REV.A.1	Page
Updated Electrical Characteristics section	4
Updated Application Information section	6

Changes from Original (AUGUST 2022) to REV.A	Page
Changed from product preview to production data	All

PACKAGE OUTLINE DIMENSIONS

TDFN-3x3-8L

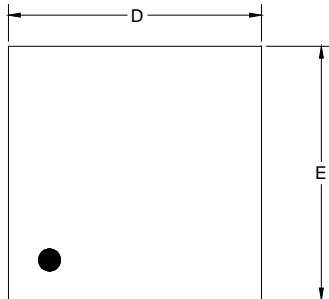

TOP VIEW

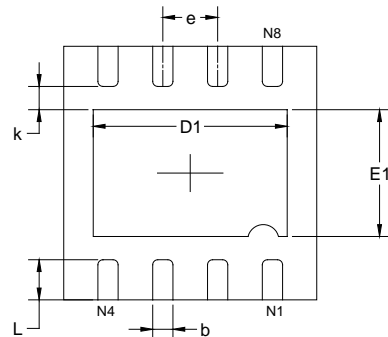

BOTTOM VIEW

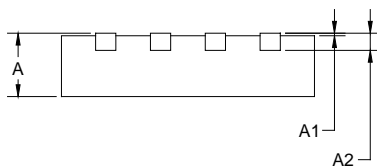

SIDE VIEW

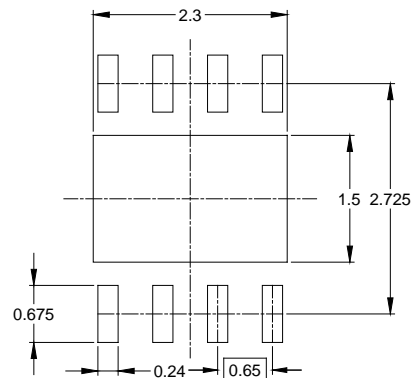

RECOMMENDED LAND PATTERN (Unit: mm)

Symbol	Dimensions In Millimeters		Dimensions In Inches	
	MIN	MAX	MIN	MAX
A	0.700	0.800	0.028	0.031
A1	0.000	0.050	0.000	0.002
A2	0.203 REF		0.008 REF	
D	2.900	3.100	0.114	0.122
D1	2.200	2.400	0.087	0.094
E	2.900	3.100	0.114	0.122
E1	1.400	1.600	0.055	0.063
k	0.200 MIN		0.008 MIN	
b	0.180	0.300	0.007	0.012
e	0.650 TYP		0.026 TYP	
L	0.375	0.575	0.015	0.023

NOTE: This drawing is subject to change without notice.

PACKAGE INFORMATION

TAPE AND REEL INFORMATION

REEL DIMENSIONS



TAPE DIMENSIONS



NOTE: The picture is only for reference. Please make the object as the standard.

KEY PARAMETER LIST OF TAPE AND REEL

Package Type	Reel Diameter	Reel Width W1 (mm)	A0 (mm)	B0 (mm)	K0 (mm)	P0 (mm)	P1 (mm)	P2 (mm)	W (mm)	Pin1 Quadrant
TDFN-3×3-8L	13"	12.4	3.35	3.35	1.13	4.0	8.0	2.0	12.0	Q1

000001

PACKAGE INFORMATION

CARTON BOX DIMENSIONS



NOTE: The picture is only for reference. Please make the object as the standard.

KEY PARAMETER LIST OF CARTON BOX

Reel Type	Length (mm)	Width (mm)	Height (mm)	Pizza/Carton
13"	386	280	370	5

DD0002