

### GENERAL DESCRIPTION

The SGM40567 is designed for the monolithic circuit with high-precision linear constant-current, and constant-voltage charging, which is specifically for small capacity Li-Ion/polymer Li-Ion secondary battery. It can complete the whole processes of pre-charge, fast-charge, trickle floating charge, voltage fold-back holding, resistive voltage drop compensation and recharge stand-alone. The maximum charge voltage is fixed with five options:

- SGM40567-3.65 corresponds to 3.65V/3.709V/4.547V
- SGM40567-4.05 corresponds to 4.05V/4.108V/5.047V
- SGM40567-4.2 corresponds to 4.2V/4.257V/5.237V
- SGM40567-4.3 corresponds to 4.3V/4.356V/5.367V
- SGM40567-4.4 corresponds to 4.4V/4.466V/5.489V

The charge current is set with the external resistor. The slow blinking LED indicates charging in progress and the continuous shining LED within a certain time indicates charging completion, which can be charged even with weak energy. It can operate with constant-voltage power supply, additionally, depending on its features and control structure. It can charge for the loose coupling coil with large voltage fluctuations and it also works for the solar batteries with reverse current. Therefore, it can provide flexible power supply options for wearable devices and mini portable devices. It has the voltage fold-back holding function and thermal current limit function so that the external power source can be used to supply power to the load for a long time safely and stably.

The SGM40567 is available in a Green WLCSP-0.92×1.16-6B package and is rated over the -40°C to +125°C temperature range.

### TYPICAL APPLICATION

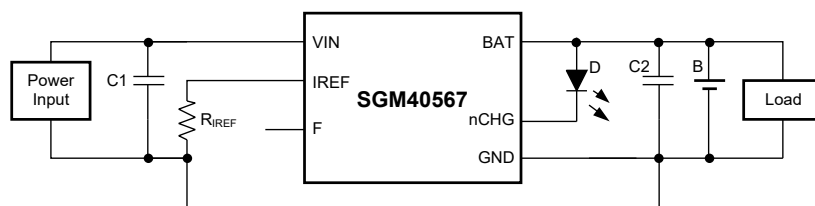

Figure 1. Typical Application Circuit

### FEATURES

- Stand-Alone Working of Complete Processes for Single-Cell Battery Charging
- Suitable for Li-Ion Phosphate Battery/ Li-Ion/Polymer Li-Ion/Lithium Titanate/ Nickel-Metal Hydride Secondary Battery and EDLC Capacitor Charging
- Optional Maximum Charge Voltage: 3.65V to 5.5V
- High Accuracy Safe and Fast Charging
- 4% Output Voltage Fold-Back Holding Function
- Works with Loose Coupling Coil
- Works with Solar Batteries
- Saturated Conduction Charging
- Automatic Thermal Current Limit
- Power Saving Indication Mode
- Available in a Green WLCSP-0.92×1.16-6B Package

### APPLICATIONS

- Bluetooth Headsets, Bluetooth Mouses
- Wireless Thermometers, Wireless Oximeters, Wireless Pulsimeters
- Active Keys, Active Beacons
- Photovoltaic Storage Maintenance, Hub Dynamo Storage Maintenance



## PIN CONFIGURATION

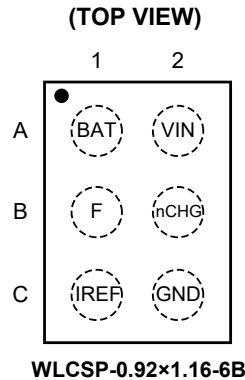

## PIN DESCRIPTION

PIN	NAME	TYPE <sup>(1)</sup>	FUNCTION
A1	BAT	P	Charger Output Pin. Connect the pin to the battery or battery & load. It is recommended to connect a 1μF (or larger value) X5R ceramic capacitor.
A2	VIN	P	Power Input Pin. It is recommended to use a 1μF (or larger value) X5R ceramic capacitor from VIN pin to ground to get good power supply decoupling. This ceramic capacitor should be placed as close as possible to VIN pin.
B1	F	I/O	Charge Voltage Setting and EDLC Capacitor Intermediate Voltage Balance Pin. When the battery is charging and $V_{BAT} > 2.0V$ , it starts to detect the external connection of this pin. Take SGM40567-4.3 for example: When the pin is ground level, the maximum charge voltage is set to 4.3V. When the pin is BAT level, the maximum charge voltage is set to 4.356V. When the pin is floating or near to the half of BAT level, the maximum charge voltage is set to 5.367V, and this pin is transformed into the half of BAT level. When the voltage of F pin deviates from $50\% \times V_{BAT}$ , it starts to source current or sink current to make a regulation.
B2	nCHG	O	Charge Status Indication. Period $T = 1280ms$ when the battery is charging, this pin sinks current intermittently in $T/8$ . When charging is complete, this pin sinks current continuously for 40 indication cycles, that is 51.2s, then the nCHG is high impedance.
C1	IREF	I/O	Maximum Charge Current Setting and Prohibiting Charging Control Pin. Connect a resistor between IREF and GND pins to set the maximum charge current according to the following formula:  $I_{CHG} \leq 400mA: I_{CHG} = \frac{24000}{R_{IREF}}(mA)$ $I_{CHG} > 400mA: I_{CHG} = \frac{20500}{R_{IREF}} + 58(mA)$ where $R_{IREF}$ is in $k\Omega$ . The resistor should be placed as close to this pin as possible. When disabled, $V_{IREF} = 0V$ . When this pin is pulled higher than 1.6V, the charging function is prohibited.
C2	GND	G	Ground.

### NOTE:

1. I = Input, O = Output, IO = Input/Output, G = Ground, P = Power for the Circuit, IC = Reserving for Internal Connection, NC = Not Connect.

# Small Capacity Compact Battery Charger for Loosely Coupled Wireless Charging/Solar Charging

## SGM40567

### ELECTRICAL CHARACTERISTICS

( $V_{IN} = 5V$ ,  $V_{BAT} = 3.3V$ ,  $F = GND$ ,  $R_{IREF} = 120k\Omega$ , nCHG float,  $T_J = +25^\circ C$ , unless otherwise noted.)

PARAMETER	SYMBOL	CONDITIONS	MIN	TYP	MAX	UNITS	
<b>Static Characteristics</b>							
Supply Voltage Range			2.7		7.5	V	
Charge Current Range			5		700	mA	
Maximum Output Current at Output Voltage Fold-Back Holding State <sup>(1)</sup>	$I_P$	$V_{IN} - V_{BAT} = 1V$ , $R_{IREF} = 13k\Omega$		700		mA	
Working Current at Output Voltage Fold-Back Holding State	$I_{OPF}$	$I_{BAT} = 0mA$ , average GND current		72	110	$\mu A$	
Current at Stable Charging State	$I_{OPN}$	$R_{IREF} = 600k\Omega$ , average GND current		100	135	$\mu A$	
Current at Diode Charging State	$I_{OPD}$	$V_{IN}$ is connected to 5V through a 10k $\Omega$ resistor, average GND current		15		$\mu A$	
BAT Leakage Current without Input	$I_{RB}$	$V_{IN}$ float, $V_{BAT} = 5.5V$		0.08		$\mu A$	
$V_{IN}$ Current when Disable	$I_{P\_DIS}$	$V_{IREF} = 2V$ , average $V_{IN}$ current		7.5	10	$\mu A$	
BAT Leakage Current when Disable	$I_{SD}$	$V_{IREF} = 2V$ , average BAT current		0.2		$\mu A$	
<b>Charging and Output Voltage Fold-Back Holding Characteristics</b>							
Maximum Charging Voltage	$V_{CH}$	$F = GND$ , $I_{BAT} = 6mA$	SGM40567-3.65	3.617	3.65	3.683	V
			SGM40567-4.05	4.016	4.05	4.084	
			SGM40567-4.2	4.166	4.20	4.234	
			SGM40567-4.3	4.266	4.30	4.334	
			SGM40567-4.4	4.366	4.40	4.434	
	$+1.5\%V_{CH}$	$F = BAT$ , $I_{BAT} = 6mA$	SGM40567-3.65	3.675	3.709	3.743	
			SGM40567-4.05	4.073	4.108	4.143	
			SGM40567-4.2	4.222	4.257	4.292	
			SGM40567-4.3	4.321	4.356	4.391	
			SGM40567-4.4	4.431	4.466	4.501	
	$+25\%V_{CH}$	$F$ is floating or connected to the half level of BAT, $V_{IN} = 6V$ , $I_{BAT} = 6mA$	SGM40567-3.65	4.508	4.547	4.586	
			SGM40567-4.05	5.008	5.047	5.086	
			SGM40567-4.2	5.198	5.237	5.276	
			SGM40567-4.3	5.328	5.367	5.406	
			SGM40567-4.4	5.450	5.489	5.528	
Pre-Charge Voltage	$V_{RPR}$	Pre-charge voltage and maximum charge voltage ratio	56.5	60	64.5	%	
Resistance Compensation Voltage	$V_{RRDC}$	Resistance compensation voltage and maximum charging voltage ratio	1.2	2	2.7	%	
Resistance Compensation Voltage Detection Threshold	$V_{RDCC}$	Resistance compensation voltage detection threshold and maximum charging voltage ratio	0.3	2.2	4.0	%	
Output Voltage Fold-Back Holding	$V_{RFB}$	Output voltage fold-back holding and maximum charging voltage ratio	95.4	96	96.7	%	
Full-Charge Voltage Detection Threshold	$V_{RCC}$	Full-charge voltage detection threshold and maximum charging voltage ratio	97	98.5		%	
Maximum Charging Current	$I_{CHG}$	$R_{IREF} = 120k\Omega$	175	200	225	mA	
		$R_{IREF} = 600k\Omega$	33.6	40	46.4		
End of Charge Current	$I_{EOC}$	Charge termination current and maximum charge current ratio	4.2	6.5	8.8	%	
Pre-Charge Current	$I_{PR}$	Pre-charge current and maximum charge current ratio	2.5	7.5	14	%	
Floating Time of Full-Charge Voltage Detection	$t_{FLTNG}$			44		min	

# Small Capacity Compact Battery Charger for Loosely Coupled Wireless Charging/Solar Charging

## SGM40567

### ELECTRICAL CHARACTERISTICS (continued)

( $V_{IN} = 5V$ ,  $V_{BAT} = 3.3V$ ,  $F = GND$ ,  $R_{IREF} = 120k\Omega$ , nCHG float,  $T_J = +25^\circ C$ , unless otherwise noted.)

PARAMETER	SYMBOL	CONDITIONS	MIN	TYP	MAX	UNITS
<b>Input and Output Voltage Comparison Conditions</b>						
Rising Threshold	$V_{DH}$			310	400	mV
Falling Threshold	$V_{DL}$		8	25		mV
Input Current of Entering the Diode Charge	$I_{DL}$	$V_{IN} = V_{BAT} + V_{DL}$		20		mA
Input Current of Exiting the Diode Charge	$I_{DH}$	$V_{IN} = V_{BAT} + V_{DH}$		1.8		mA
<b>Chip Temperature Regulation of Charging Current</b>						
Temperature Regulation Threshold of Charge Current	$T_C$			130		$^\circ C$
<b>Control and I/O Characteristics: nCHG Indication Driving</b>						
nCHG Low-Level Sink Current	$I_{SNKL}$	$V_{nCHG} = 0.5V$	1.6	2.5	3.5	mA
		$V_{nCHG} = 12V$	2.2	4.0	5.6	
nCHG High-Impedance Leakage Current	$I_{LKG}$	$V_{nCHG} = 12V$ , $V_{IREF} = 5.5V$		0.01	1	$\mu A$
Charging Indicates Low-Level Voltage Time	$t_{ON}$			160		ms
Charging Indication Period	$t_C$			1280		ms
Continuous Low-Level Voltage Time	$t_{EOC}$			51.2		s
<b>Control and I/O Characteristics: IREF Disables Charging Input</b>						
	$V_{TIREF}$		1.4	1.5	1.6	V
<b>Control and I/O Characteristics: Equalization Driving</b>						
Equalization Drive Voltage	$V_{05R}$	F float, $V_{BAT} = 5.4V$	2.57	2.70	2.83	V
Threshold Voltage of Equalization Drive Sink Current	$V_{SINKF}$	$V_{BAT} = 5.4V$		2.77	2.83	V
Threshold Voltage Hysteresis of Equalization Drive Sink Current	$V_{SINKFHYS}$	$V_{BAT} = 5.4V$		2.74		V
Threshold Voltage of Equalization Drive Source Current	$V_{SOFURCE}$	$V_{BAT} = 5.4V$		2.66		V
Threshold Voltage Hysteresis of Equalization Drive Source Current	$V_{SOFURCEHYS}$	$V_{BAT} = 5.4V$	2.57	2.63		V
Equalization Sinking Drive Current Capability	$I_{SINKF}$	$V_{BAT} = 5.4V$ , $V_F = 2.9V$		60		mA
Equalization Sourcing Drive Current Capability	$I_{SOURCEF}$	$V_{BAT} = 5.4V$ , $V_F = 2.5V$		55		mA
Detecting the GND Threshold Voltage	$V_{LF}$	$V_{BAT} = 5.4V$		0.52	0.6	V
Detecting the GND Threshold Voltage Hysteresis	$V_{LFHYS}$	$V_{BAT} = 5.4V$	0.35	0.48		V
Detecting BAT Threshold Voltage	$V_{HF}$	$V_{BAT} = 5.4V$		$80\% \times V_{BAT}$	$83.6\% \times V_{BAT}$	V
Detecting BAT Threshold Voltage Hysteresis	$V_{HFHYS}$	$V_{BAT} = 5.4V$	$76.4\% \times V_{BAT}$	$79\% \times V_{BAT}$		V

**NOTE:**

- This current is measured when the BAT voltage drops to  $90\% \times V_{CH}$ .

# SGM40567 Small Capacity Compact Battery Charger for Loosely Coupled Wireless Charging/Solar Charging

## TYPICAL PERFORMANCE CHARACTERISTICS

$V_{IN} = 5V$ ,  $F = GND$ ,  $R_{REF} = 120k\Omega$ ,  $T_J = +25^\circ C$ , unless otherwise noted.

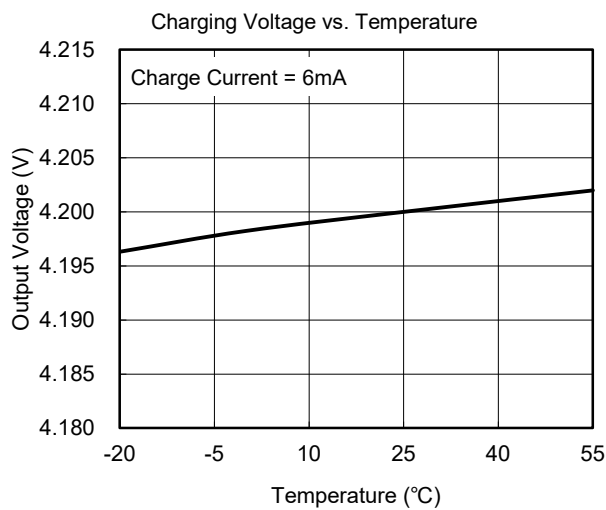
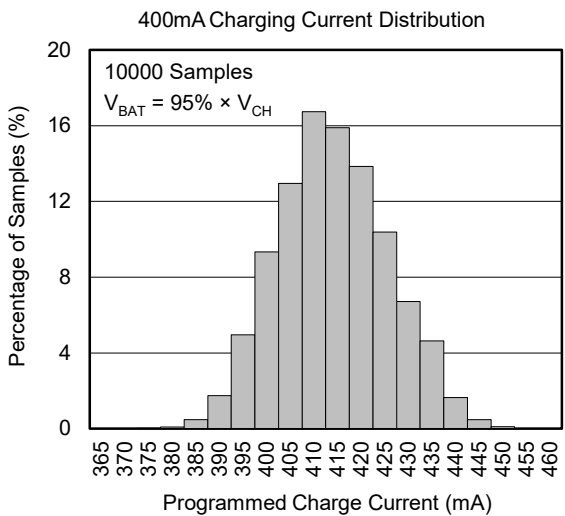
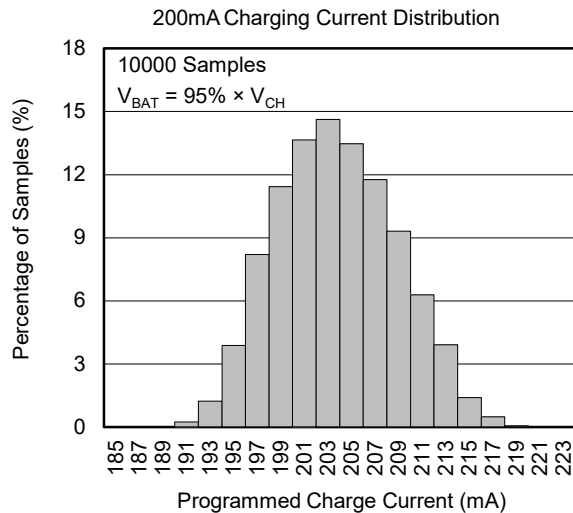
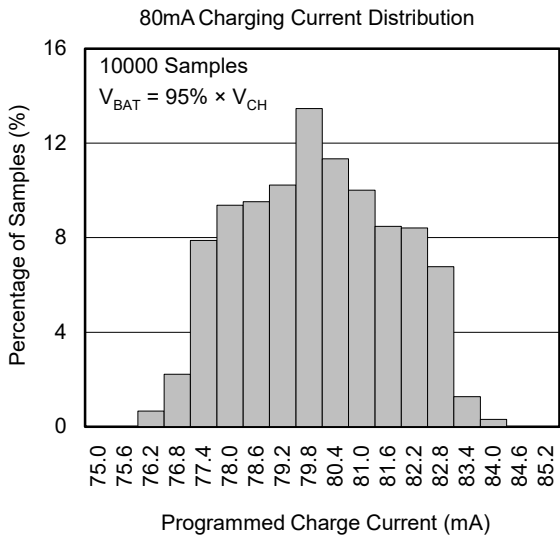
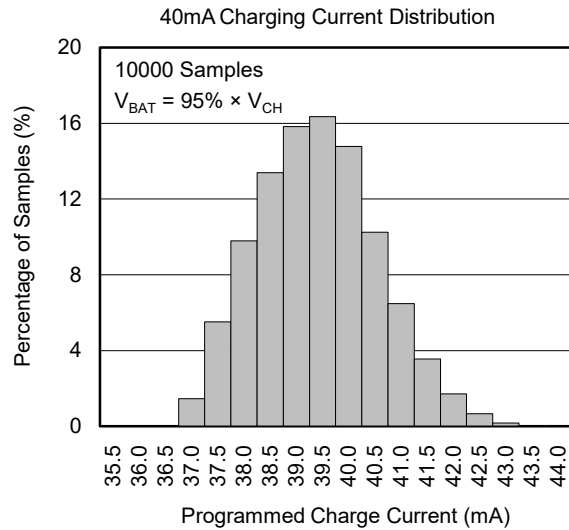
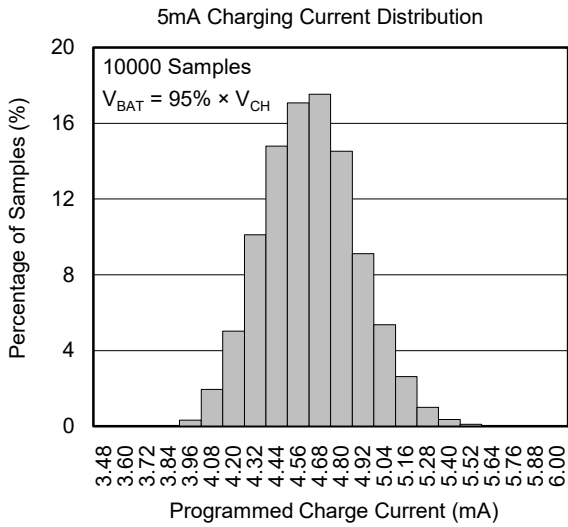

# SGM40567 Small Capacity Compact Battery Charger for Loosely Coupled Wireless Charging/Solar Charging

## TYPICAL PERFORMANCE CHARACTERISTICS (continued)

$V_{IN} = 5V$ ,  $F = GND$ ,  $R_{REF} = 120k\Omega$ ,  $T_J = +25^\circ C$ , unless otherwise noted.

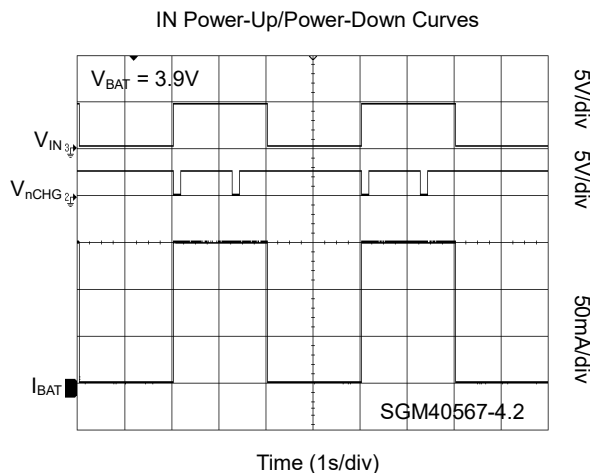
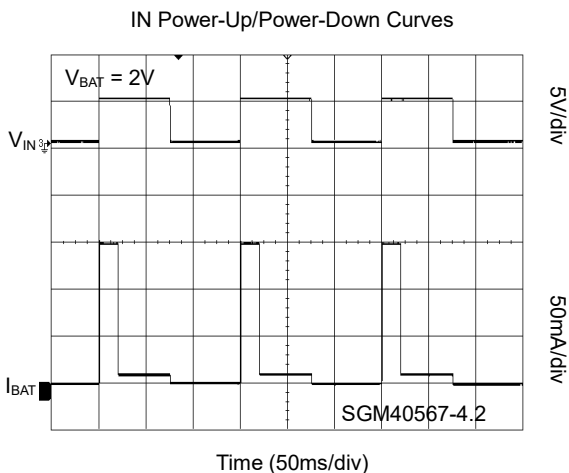
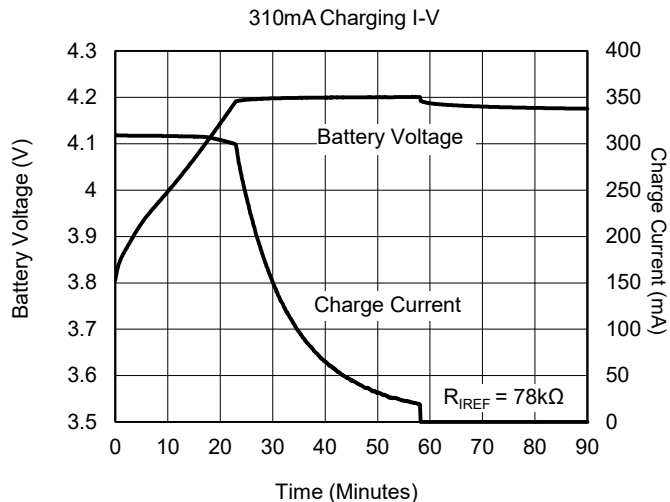
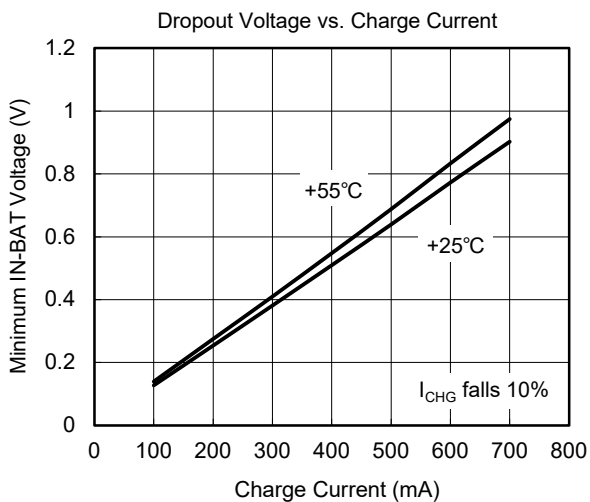
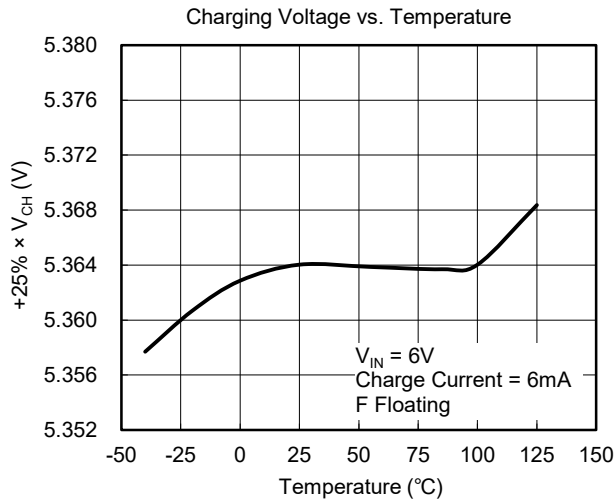
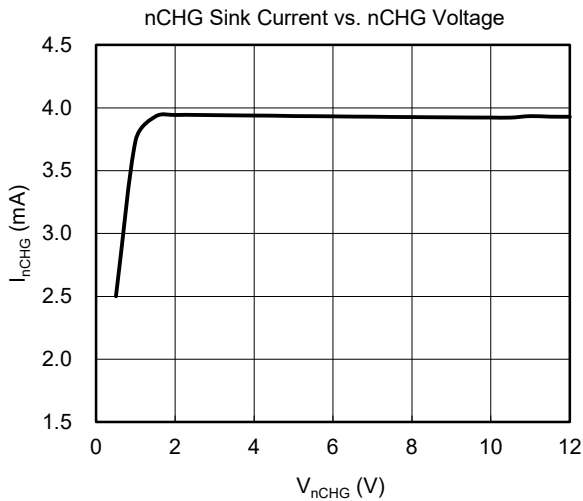

# SGM40567 Small Capacity Compact Battery Charger for Loosely Coupled Wireless Charging/Solar Charging

## TYPICAL PERFORMANCE CHARACTERISTICS (continued)

$V_{IN} = 5V$ ,  $F = GND$ ,  $R_{REF} = 120k\Omega$ ,  $T_J = +25^\circ C$ , unless otherwise noted.

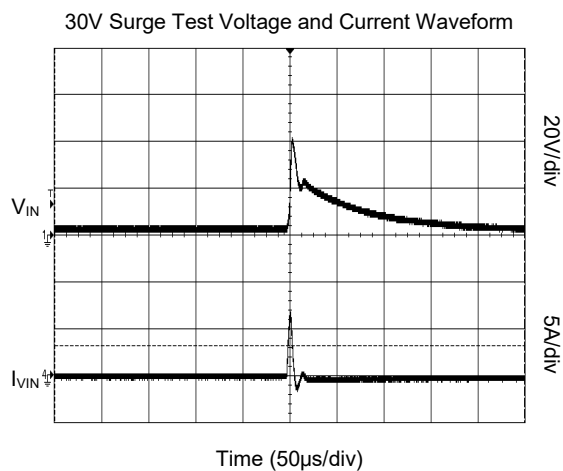
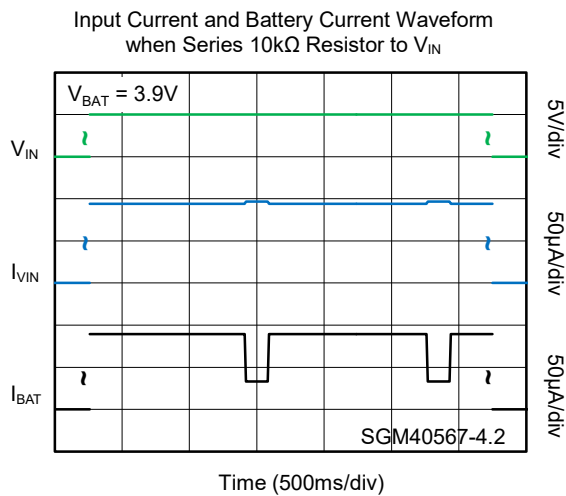



# SGM40567 Small Capacity Compact Battery Charger for Loosely Coupled Wireless Charging/Solar Charging

## FUNCTIONAL BLOCK DIAGRAM

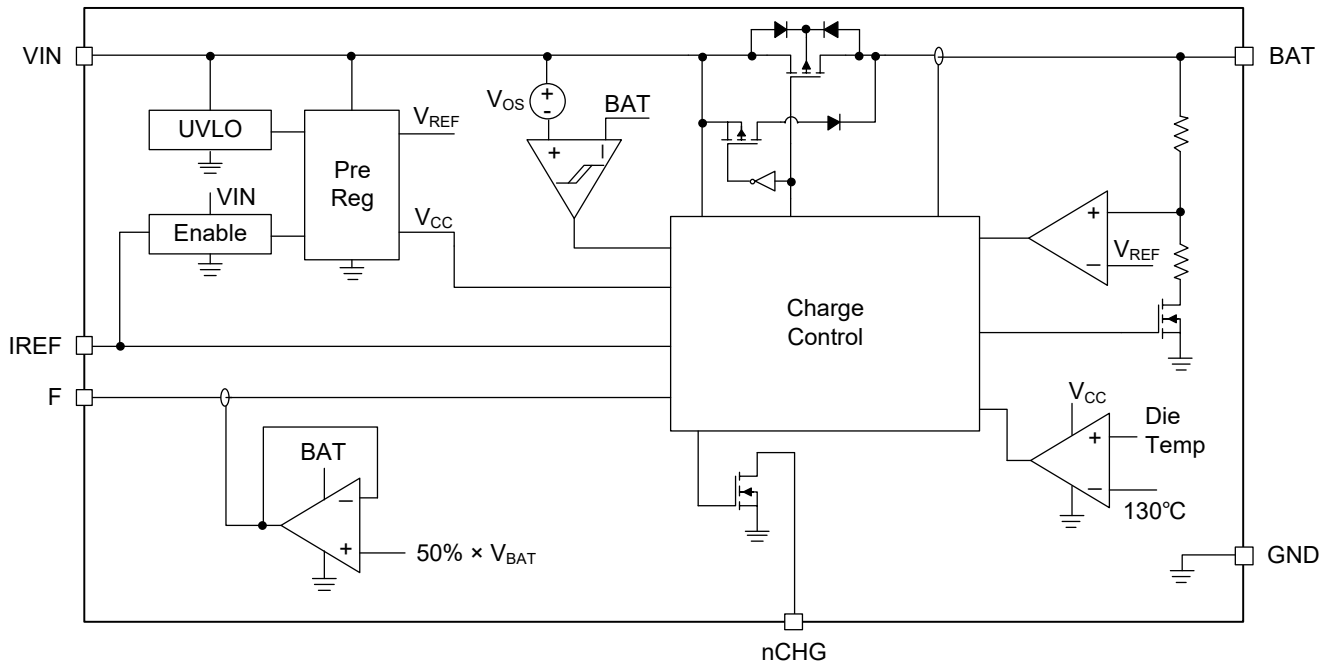

Figure 2. Block Diagram

## nCHG DRIVING TIMING DIAGRAM

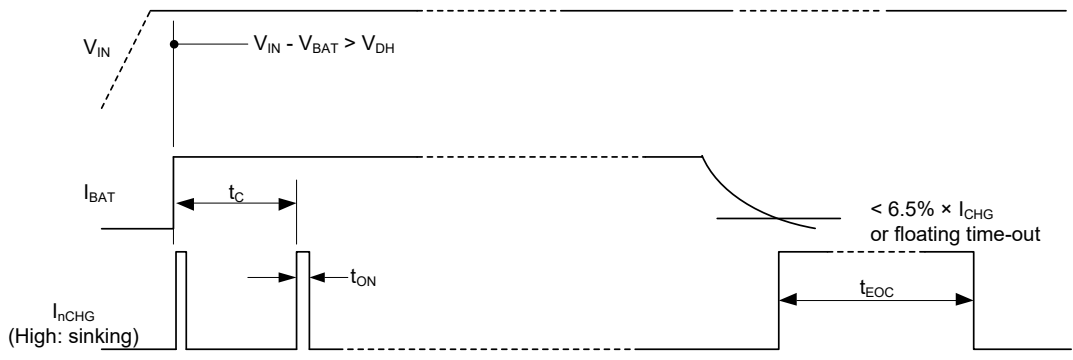
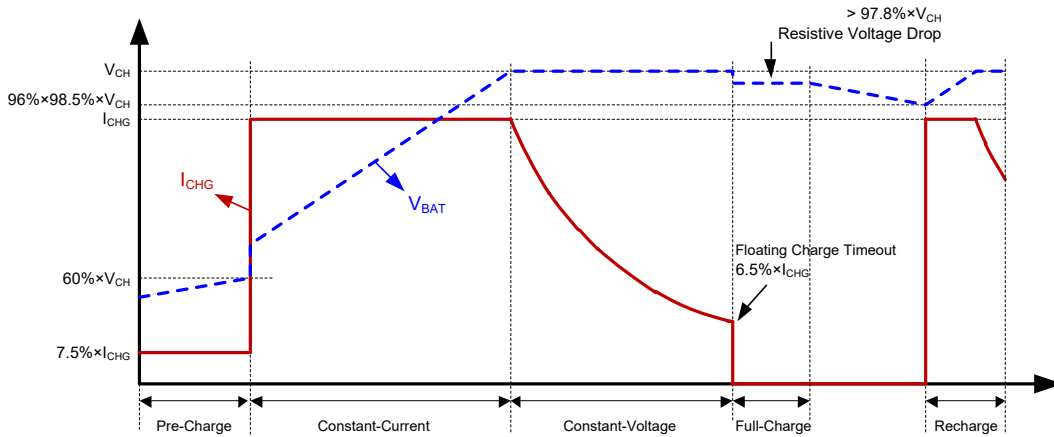
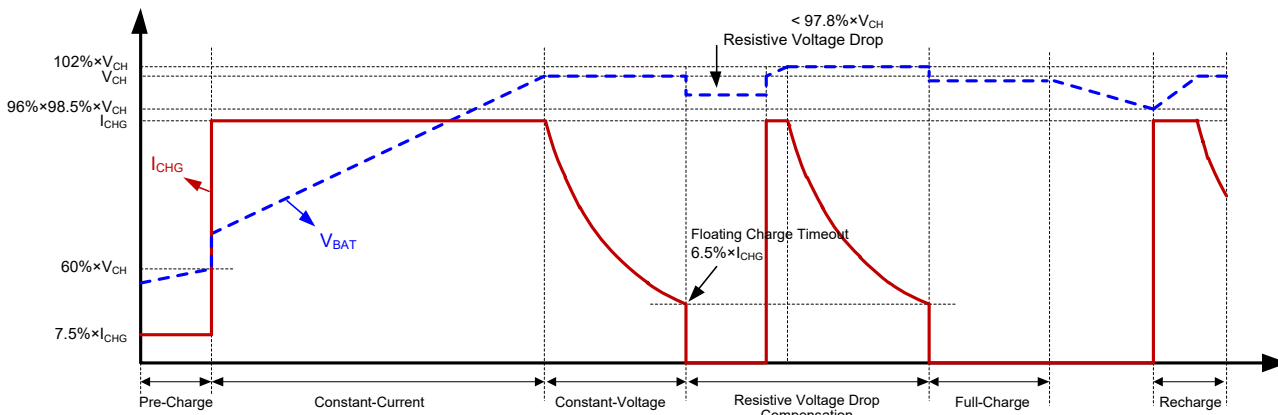

Figure 3. nCHG Driving Timing Diagram

**CHARGING CYCLE SCHEMATIC DIAGRAM**



**Figure 4. Charge Profile (Resistive Voltage Drop  $< 2.2\% \times V_{CH}$ )**



**Figure 5. Charge Profile (Resistive Voltage Drop  $> 2.2\% \times V_{CH}$ )**

# SGM40567 Small Capacity Compact Battery Charger for Loosely Coupled Wireless Charging/Solar Charging

## DETAILED DESCRIPTION

The SGM40567 charging process is designed to improve the small battery application based on the traditional constant-current and constant-voltage charging process. It can satisfy the requirement of current accuracy for small capacity battery. Besides, it is also suitable for external power supply which is continuous but unstable, and it can support fast charge safely with continuous load. Therefore, it can cooperate with low-cost loose coupling coils to achieve wireless charging, and it can employ solar cells to supplement power.

The SGM40567 has the functions of pre-charge, fast-charge, trickle floating charge, voltage fold-back holding, resistive voltage drop compensation, recharge and so on. The maximum charging current  $I_{CHG}$  is set with the external resistor  $R_{IREF}$ . When the output voltage is lower than 60% of the maximum charging voltage,  $7.5\% \times I_{CHG}$  current is used for pre-charge. Then fast-charging with the set value  $I_{CHG}$  until the output voltage is greater than 98.5% of the maximum charging voltage and exceeds 44 minutes, or after the charging current is less than  $6.5\% \times I_{CHG}$  (this condition is used as the full-charge judgment condition). After that, it goes into output voltage fold-back holding state of the constant-voltage function, and this voltage is lower than 4% of the maximum charging voltage. After the output voltage fold-back holding function is completed, if the output voltage drops more than 2.2% of the maximum charging voltage, the resistive voltage drop compensation is performed, and the output voltage is further increased by 2%. If the drop is less than 2.2% of the maximum charging voltage, the output voltage is maintained. When the output voltage continues to reduce more than 1.5%, the voltage fold-back holding state is exited, and a charging process is restarted.

When F is floating and the full-charge judgment condition is satisfied, the output voltage fold-back holding state does not start, and the maximum charging voltage is maintained as the output.

The SGM40567 charges the battery in two paths, one is the power transistor and the other is the Schottky diode. When power-on, the diode is preferred to charge the battery. When the dropout voltage between input and output is greater than  $V_{DH}$ , the diode is disconnected, switching to the power transistor to charge the battery. When the dropout voltage

between input and output is lower than  $V_{DL}$ , the power transistor is disconnected and the diode is charging the battery again. The current charged by the diode is determined by the input and output voltage difference. The charge current of the power transistor is set by the  $R_{IREF}$ . When the diode is charging, the SGM40567 has a low quiescent current (about  $15\mu A$ ), which is very suitable for a weak energy supply system like a solar cell.

When it is detected that the output voltage reaches 98.5% of the maximum charging voltage, the power transistor charging with the constant-voltage function is forced, which can prevent the battery from being overcharged.

When the SGM40567 starts charging, it will be charged with the set  $I_{CHG}$  for a certain time, about 20ms, using to activate the battery. The SGM40567 has internal UVLO function, and the threshold voltage is 2.4V, the hysteresis is 200mV. However, when the input voltage is lower than 2.2V, it will not stop charging immediately, but wait for an indication period to operate, which can maintain the stability of the charging current effectively.

The SGM40567 relies on great thermal contact and heat dissipation with the board. When the temperature of the device is higher than  $+130^{\circ}C$ , the charging current is actively reduced to prevent overheating damage. With the small device, the heat dissipation capability of the device and the degree of heat tolerance of the specific application scenario will determine the maximum power dissipation of the SGM40567.

The design choice of charging current requires a combination of battery capacity and load characteristics of the input supply. The maximum charging voltage needs to be selected with reference to the voltage specification of the battery or mass capacitor. Determine the connection of pin F according to the selection. The relationship between the connection of F and the maximum charging voltage can be found in the Device Selection Table section.

When F is floating or close to the half of the BAT voltage, the output is the half of the BAT. When it deviates from  $50\% \times V_{BAT}$ , it has a source/sink current capability of about 55mA.

DETAILED DESCRIPTION (continued)

Motion Design after Full-Charge

If the external power supply exists after charging, the SGM40567 will change to maintain the output voltage in the voltage fold-back holding state, and release the constant-current limitation and supply the load system continuously. The output voltage at voltage fold-back holding state is lower than 4% of the maximum charging voltage, and maintaining at voltage fold-back holding state does not affect the cycle life of the battery. This design avoids the rapid aging caused by the highest voltage for a long time and the normal aging of continuous alternating charge and discharge, which also maintains the battery close to the saturation capacity.

When the external power supply cannot maintain the holding voltage, the output voltage is lower than 98.5% of the holding voltage or more than one indication period occurs, exit the voltage fold-back holding state and restart the charging process.

Resistive Voltage Drop Compensation

After the SGM40567 detects that the full-charge judgment condition is met, the device stops charging and check the output voltage change. If the output voltage does not drop 2.2%, the judgment of the full state will be maintained, and the output will be maintained by the fold-back holding voltage, otherwise, the compensation will be started, the output voltage will be increased by about 2%, recharge again as the maximum charging voltage. The voltage drop is only detected for a certain period of time, and is only compensated once, and finally the output is maintained with the fold-back holding voltage.

Loose Coupling Charging

The SGM40567 is designed to charge when the input voltage is slightly above the battery voltage and close to its highest withstand voltage, and it does not require constant and stable supply of current and voltage. When using a power supply with limited output capability, the IREF pin can be connected to GND, so that the SGM40567 is in a saturated conduction state during charging operation, maximizing the power supply capability and the current passing capability of the SGM40567. This saturation conduction state still has the function of preventing overcharging of the battery, that is, after approaching the maximum charging voltage of 98.5%, it enters constant-voltage charging.

Small Capacity Battery Charging

For small-capacity batteries (such as EDLC capacitors), the charging current is small, and the load current accounts for a large proportion of the charging current. After entering the floating charge, there is still a large charging current, which will cause a voltage drop in the equivalent series resistance of the charging path, leading to the battery terminal voltage to be lower than the BAT pin voltage. The SGM40567 automatically detects this resistive voltage drop. If the resistive voltage drop exceeds 2.2%, the maximum charge voltage will be increased accordingly.

From the Figure 1, the charging current of the SGM40567 is set by the resistor R<sub>IREF</sub>. If it needs to externally control the charging current, refer to Figure 6, use the controller's IO to generate two different current settings (such as the left circuit), or use PWM to synthesize a voltage applied to one end of the current setting resistor for detailed control.

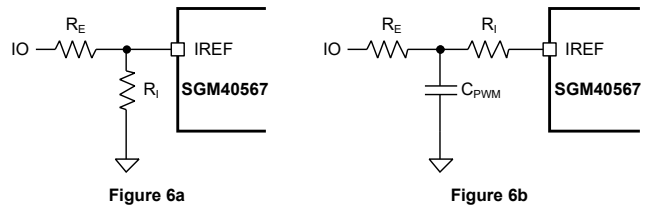

Figure 6. Two Ways to Control the Charging Current

For Figure 6a formula:

$$I_{CHG} \leq 400mA: I_{CHG} = \left( 1.185 \times \left( \frac{1}{R_E} + \frac{1}{R_I} \right) - \frac{V_{IO}}{R_E} \right) \times 20250 (mA)$$

$$I_{CHG} > 400mA: I_{CHG} = \left( 1.185 \times \left( \frac{1}{R_E} + \frac{1}{R_I} \right) - \frac{V_{IO}}{R_E} \right) \times 17300 + 58 (mA)$$

For Figure 6b formula:

$$I_{CHG} \leq 400mA: I_{CHG} = \left( \frac{1.185 - V_{IO} \times D}{R_E + R_I} \right) \times 20250 (mA)$$

$$I_{CHG} > 400mA: I_{CHG} = \left( \frac{1.185 - V_{IO} \times D}{R_E + R_I} \right) \times 17300 + 58 (mA)$$

D is IO signal duty ratio. R<sub>E</sub> and R<sub>I</sub> are kΩ.

# SGM40567 Small Capacity Compact Battery Charger for Loosely Coupled Wireless Charging/Solar Charging

## DETAILED DESCRIPTION (continued)

### Battery Types for Different Voltages

After selecting the different suffix models, the SGM40567 further selects different voltage trimming ranges through different connections to the F pin, which can adapt to the charging voltage of most common batteries. The full output voltage fold-back holding further ensures safety and long-term efficiency.

The SGM40567 is designed to charge the battery string and equalize the voltage across the battery when used in a two-series application of a lower single-voltage lithium titanate battery and an EDLC capacitor. Equilibrium is only performed during the charging process, after reaching equilibrium, the current consumption of the battery is about 4 $\mu$ A. The equalization circuit does not consume power when there is no charging power.

The nickel-hydrogen battery allows the self-discharge to increase when the floating voltage is increased, and the floating charge achieves a voltage balance by self-discharge. The SGM40567 does not have the ability to balance Ni-MH battery strings. When charging Ni-MH batteries, select a suitable voltage type suffix according to the voltage of 2 or 3 series connected and use F pin to connect and fine-tune.

### Light Indicator Load Design

Referring to the schematic diagram of the portion of Figure 3, the SGM40567 outputs (sinks) a constant-current with a duty ratio of 1/8 during charging, and continuously outputs 40 indication periods after being fully charged. With its 2.3mA constant-current output, it can adapt to the weak external power supply. When using IO to read the charge state, the capacitor can be directly connected in parallel with nCHG, and the capacitor can be kept in the output state during the period when nCHG is not driven (high impedance), which is convenient for reading.

### Parallel Expansion of Charging Current and Saturation Conduction Charging

Using multiple SGM40567s in parallel can increase the charging current. Multiple SGM40567 dispersion arrangements increase the heat dissipation area. When connected in parallel, each chip is configured with R<sub>IREF</sub>. Select any one of the chips to configure the R<sub>IREF</sub> to be slightly smaller. The charging current will be slightly larger than other chips (take a small 9% as an example, the charging current is 10% larger), then the chip is detected lagging behind the other chips, so the nCHG of the chip can be used as a global indication output.

When a source of limited power is used to charge a battery with a larger capacity relative to the source, the current supply capability of the source tends to be lower than the safe charging current of the battery. For example, a solar panel with a maximum power of 5W-10 strings has a maximum output capacity of 1.2A-4V, and a safe current of less than 1.8Ah in 0.7C. At this time, the charging current is set according to the safe current of the battery. During the constant-current charging, the SGM40567 will be in a saturated conduction state, and the SGM40567 will start to control the charging current only when the battery voltage is near full. The charging current in this state is limited by the source's own capability. The consumption of the SGM40567 insertion is determined by its on-resistance, which can effectively utilize the source's capability.

### Matching Energy Storage Capacitors to Improve the Impact of Sudden Load

The constant-voltage/constant-current control capability of the SGM40567 can be used to isolate the impact of sudden load on small-capacity batteries or fragile power systems, such as isolated NB-IoT and GPRS transmission bursts to prevent system power failure. When the load is burst, it is powered by the storage capacitor. The charging voltage of the SGM40567 is set to a higher voltage that the system can withstand, and the charging current is set to a level suitable for the power supply characteristics.

## REVISION HISTORY

NOTE: Page numbers for previous revisions may differ from page numbers in the current version.

### Changes from Original (OCTOBER 2022) to REV.A

	Page
Changed from product preview to production data.....	All

PACKAGE OUTLINE DIMENSIONS

WLCSP-0.92x1.16-6B

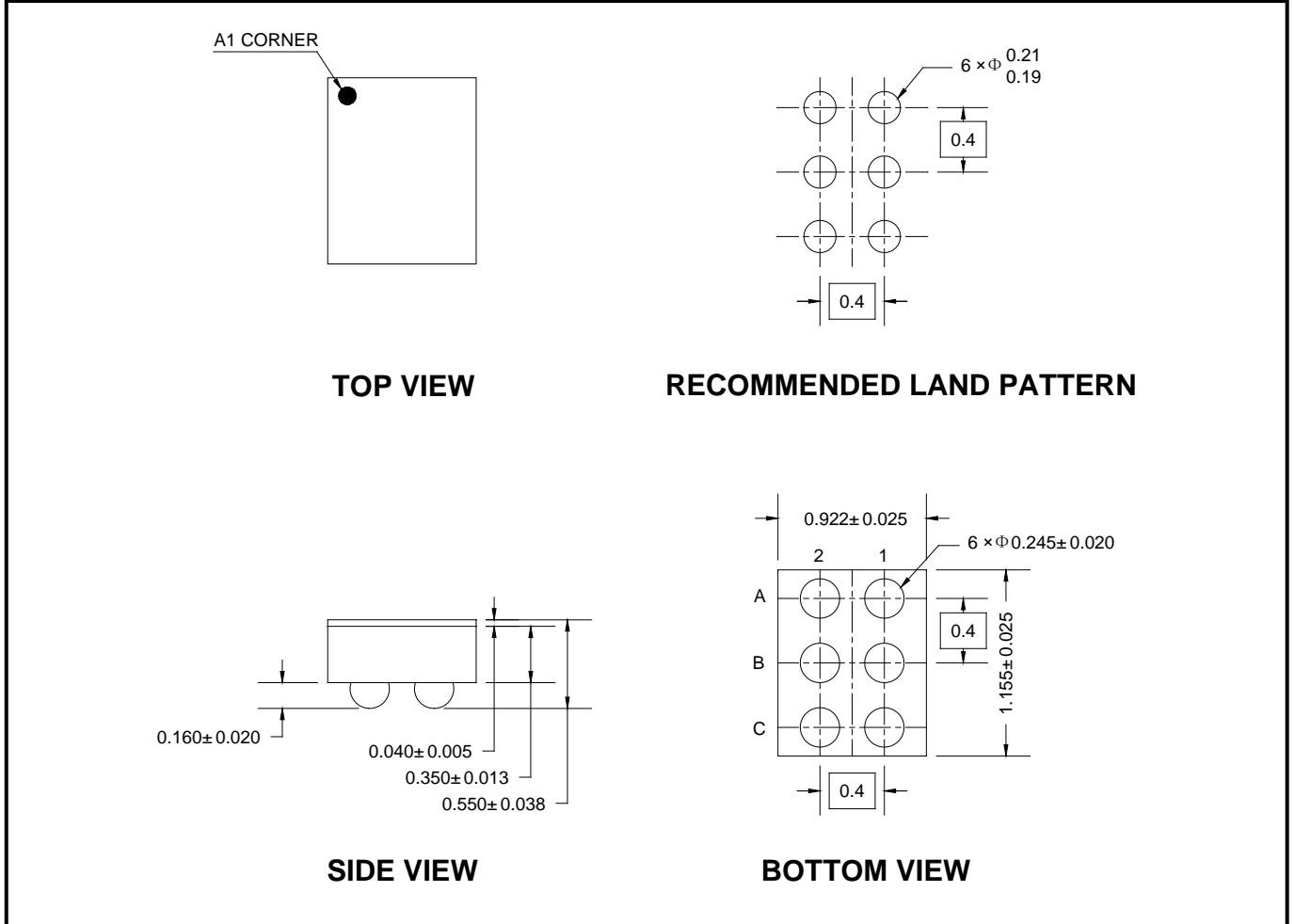

NOTES:

1. All linear dimensions are in millimeters.
2. This drawing is subject to change without notice.

# PACKAGE INFORMATION

## TAPE AND REEL INFORMATION

### REEL DIMENSIONS

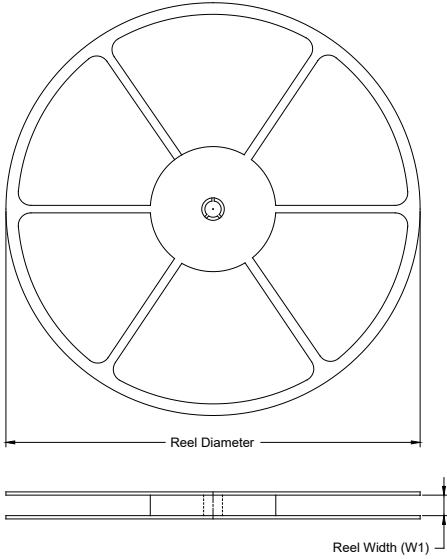

### TAPE DIMENSIONS



NOTE: The picture is only for reference. Please make the object as the standard.

### KEY PARAMETER LIST OF TAPE AND REEL

Package Type	Reel Diameter	Reel Width W1 (mm)	A0 (mm)	B0 (mm)	K0 (mm)	P0 (mm)	P1 (mm)	P2 (mm)	W (mm)	Pin1 Quadrant
WLCSP-0.92×1.16-6B	7"	9.5	1.02	1.26	0.66	4.0	4.0	2.0	8.0	Q1

000001

# PACKAGE INFORMATION

## CARTON BOX DIMENSIONS



NOTE: The picture is only for reference. Please make the object as the standard.

## KEY PARAMETER LIST OF CARTON BOX

Reel Type	Length (mm)	Width (mm)	Height (mm)	Pizza/Carton
7" (Option)	368	227	224	8
7"	442	410	224	18

DD0002