



SGM8748

155ns, 3V/5V, Single-Supply, Low Power, Rail-to-Rail I/O Comparator

GENERAL DESCRIPTION

The SGM8748 is a dual, high speed, low power comparator, which features a fast 155ns propagation delay. The device is optimized for low voltage operation on 3V or 5V supply, and consumes only 45µA supply current.

The SGM8748 supports rail-to-rail input and output operation. The input common mode voltage range is from $-0.1V$ to $(+V_S) + 0.1V$, and the output voltage swing is within 0.2V of the rails without external pull-up or pull-down resistor. The device can be compatible with CMOS and TTL logics. Any input or output pin has a continuous short-circuit protection to both power supply rails. The SGM8748 has an internal hysteresis for reducing comparator sensitivity to noise, even when the input signals move slowly.

The SGM8748 is available in Green SOIC-8 and MSOP-8 packages. It is rated over the $-40^{\circ}C$ to $+85^{\circ}C$ temperature range.

FEATURES

- **High Speed: 155ns Propagation Delay (10mV Overdrive)**
- **Low Supply Current: 45µA (TYP) at $V_S = 3V$**
- **Low Offset Voltage: 0.8mV (TYP)**
- **Rail-to-Rail Input and Output**
- **Supply Voltage Range: 2.7V to 5.5V**
- **Optimized for 3V and 5V Applications**
- **Output Swing to within 190mV from Rails with 4mA Output Current**
- **Supports CMOS or TTL Logic**
- **Internal Hysteresis for Reducing Comparator Sensitivity to Noise**
- **$-40^{\circ}C$ to $+85^{\circ}C$ Operating Temperature Range**
- **Available in Green SOIC-8 and MSOP-8 Packages**

APPLICATIONS

3V or 5V Applications
Portable/Battery-Powered Equipment
Mobile Phones
Zero-Crossing Detectors
Threshold Detectors
Line Receiver Units

PACKAGE/ORDERING INFORMATION

MODEL	PACKAGE DESCRIPTION	SPECIFIED TEMPERATURE RANGE	ORDERING NUMBER	PACKAGE MARKING	PACKING OPTION
SGM8748	SOIC-8	-40°C to +85°C	SGM8748YS8G/TR	SGM 8748YS8 XXXXX	Tape and Reel, 2500
	MSOP-8	-40°C to +85°C	SGM8748YMS8G/TR	SGM8748 YMS8 XXXXX	Tape and Reel, 4000

MARKING INFORMATION

NOTE: XXXXX = Date Code and Vendor Code.

XXXXX

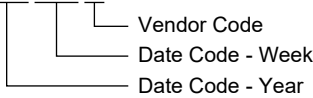

Green (RoHS & HSF): SG Micro Corp defines "Green" to mean Pb-Free (RoHS compatible) and free of halogen substances. If you have additional comments or questions, please contact your SGMICRO representative directly.

ABSOLUTE MAXIMUM RATINGS

Supply Voltage, +V _S to -V _S	6V
Differential Input Voltage, V _{ID} 	V _S
Voltage at Input/Output Pins	(-V _S) - 0.3V to (+V _S) + 0.3V
Junction Temperature	+150°C
Storage Temperature Range	-65°C to +150°C
Lead Temperature (Soldering, 10s)	+260°C
ESD Susceptibility	
HBM	6000V
MM	400V

RECOMMENDED OPERATING CONDITIONS

Operating Temperature Range	-40°C to +85°C
-----------------------------------	----------------

OVERSTRESS CAUTION

Stresses beyond those listed in Absolute Maximum Ratings may cause permanent damage to the device. Exposure to absolute maximum rating conditions for extended periods may affect reliability. Functional operation of the device at any conditions beyond those indicated in the Recommended Operating Conditions section is not implied.

ESD SENSITIVITY CAUTION

This integrated circuit can be damaged if ESD protections are not considered carefully. SGMICRO recommends that all integrated circuits be handled with appropriate precautions. Failure to observe proper handling and installation procedures

can cause damage. ESD damage can range from subtle performance degradation to complete device failure. Precision integrated circuits may be more susceptible to damage because even small parametric changes could cause the device not to meet the published specifications.

DISCLAIMER

SG Micro Corp reserves the right to make any change in circuit design, or specifications without prior notice.

PIN CONFIGURATIONS

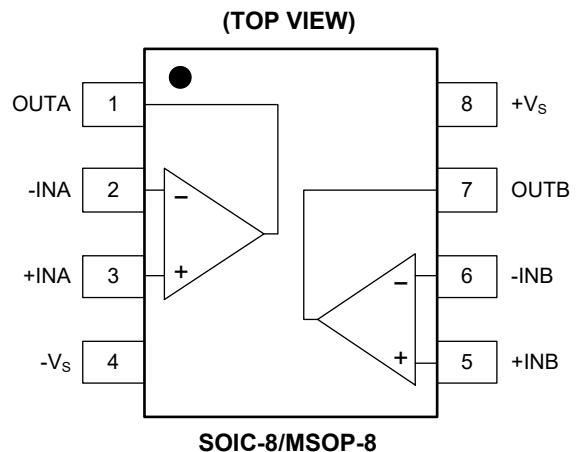

ELECTRICAL CHARACTERISTICS(V_S = 5.0V, V_{CM} = 0V, C_L = 15pF, typical values are at T_A = +25°C, unless otherwise noted.)

PARAMETER	SYMBOL	CONDITIONS	MIN	TYP	MAX	UNITS
Operating Supply Voltage ⁽¹⁾	V _S		2.7		5.5	V
Input Common Mode Voltage Range ⁽²⁾	V _{CM}		-0.1		V _S + 0.1	V
Input Offset Voltage ⁽³⁾	V _{OS}	V _S = 5V, V _{CM} = 0V		0.8	4.9	mV
		-40°C ≤ T _A ≤ +85°C			5.8	
Input Hysteresis ⁽⁴⁾	V _{HYST}	V _S = 5V, V _{CM} = 0V		2.5		mV
Output Short-Circuit Current	I _{SOURCE}	V _S = 5V, Out to V _S /2	22.5	34		mA
		-40°C ≤ T _A ≤ +85°C	19			
	I _{SINK}	V _S = 5V, Out to V _S /2		-33	-25.5	
		-40°C ≤ T _A ≤ +85°C			-21	
Common Mode Rejection Ratio ⁽⁵⁾	CMRR	V _S = 5V, V _{CM} = 0V to 5V	59	78		dB
		-40°C ≤ T _A ≤ +85°C	54			
Power Supply Rejection Ratio	PSRR	V _{CM} = 0V, V _S = 2.7V to 5.5V	58	71		dB
		-40°C ≤ T _A ≤ +85°C	54			
Output Voltage Swing from Rail	V _{OH}	V _S = 5V, I _{OUT} = 4mA		188	275	mV
		-40°C ≤ T _A ≤ +85°C			305	
	V _{OL}	V _S = 5V, I _{OUT} = -4mA		179	222	
		-40°C ≤ T _A ≤ +85°C			248	
Supply Current	I _S	V _S = 3V, I _{OUT} = 0		45	60	μA
		-40°C ≤ T _A ≤ +85°C			70	
		V _S = 5V, I _{OUT} = 0		50	69	
		-40°C ≤ T _A ≤ +85°C			83	
Propagation Delay (High to Low)		V _S = 3V, Overdrive = 10mV		155		ns
		V _S = 3V, Overdrive = 100mV		95		
Propagation Delay (Low to High)		V _S = 3V, Overdrive = 10mV		145		ns
		V _S = 3V, Overdrive = 100mV		120		
Rise Time	t _{RISE}	V _S = 3V, Overdrive = 10mV		10		ns
		V _S = 3V, Overdrive = 100mV		8		
Fall Time	t _{FALL}	V _S = 3V, Overdrive = 10mV		8		ns
		V _S = 3V, Overdrive = 100mV		6		

NOTES:

1. This value is from PSRR test.
2. This value is from PD test. For the range of common mode voltage, the maximum input common mode voltage can reach (+V_S) + 0.1V without any damage to SGM8748.
3. V_{OS} is the midway voltage for the hysteresis zone of the comparator.
4. The input hysteresis is the gap between the upper threshold where the output of the comparator switches to high position and the lower threshold where the output of the comparator switches to low position.
5. CMRR is defined over the condition of whole input common mode range.

TYPICAL PERFORMANCE CHARACTERISTICS

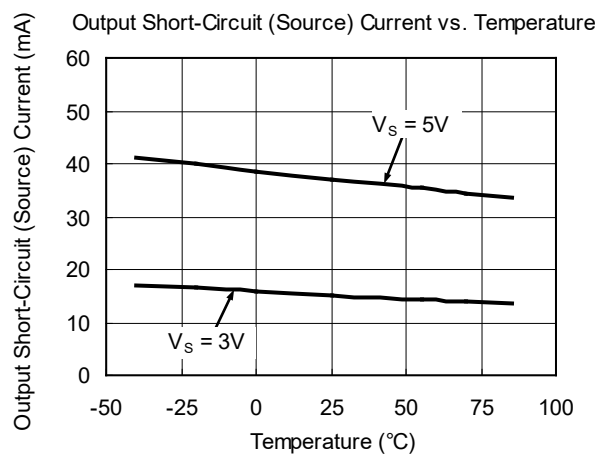
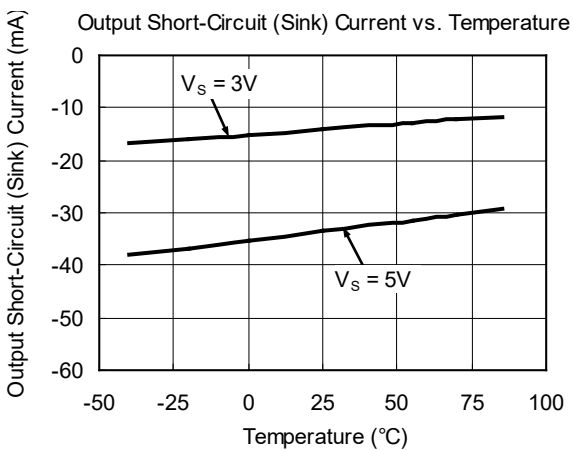
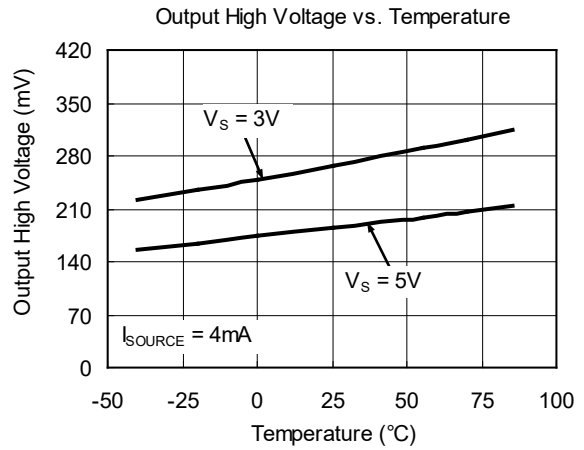
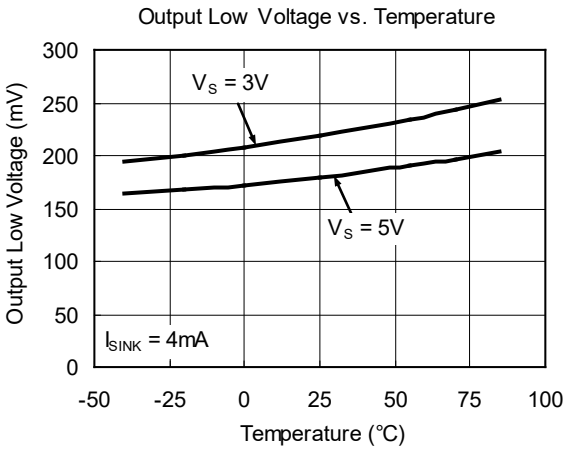
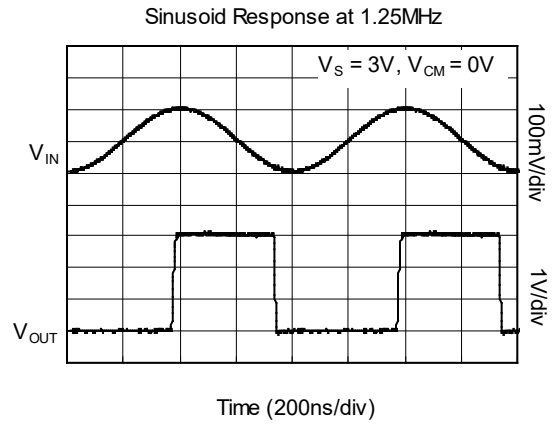
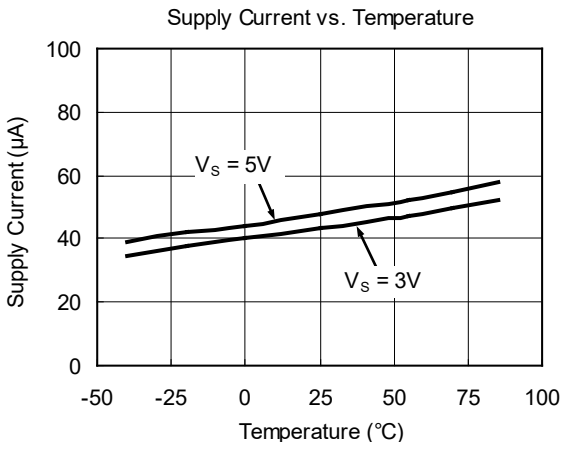

TYPICAL PERFORMANCE CHARACTERISTICS (continued)

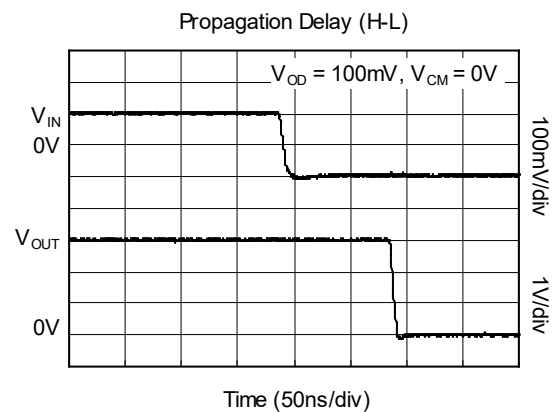
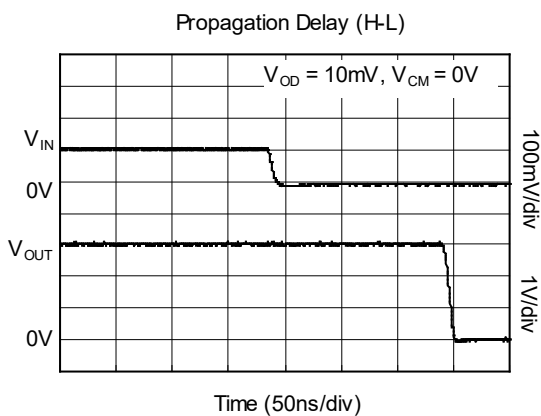
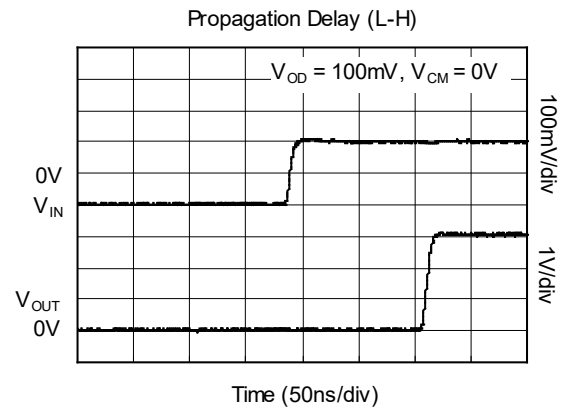
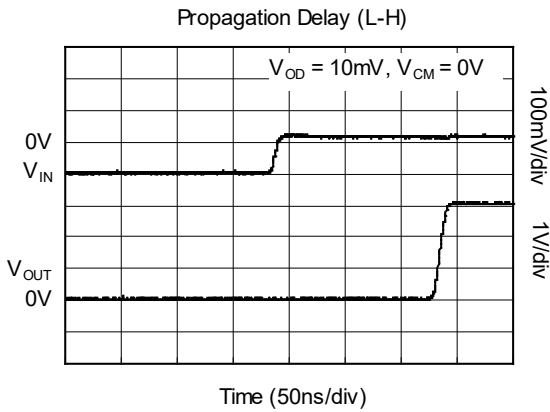
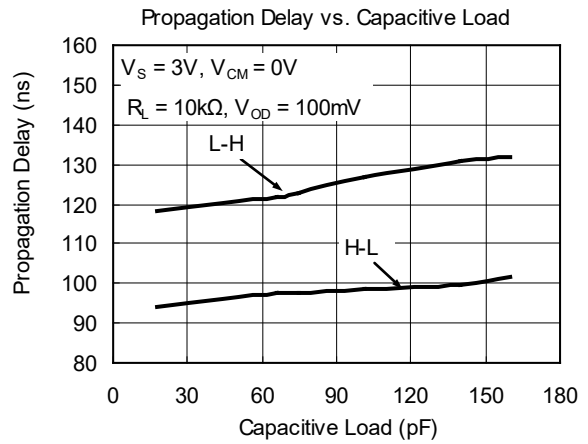
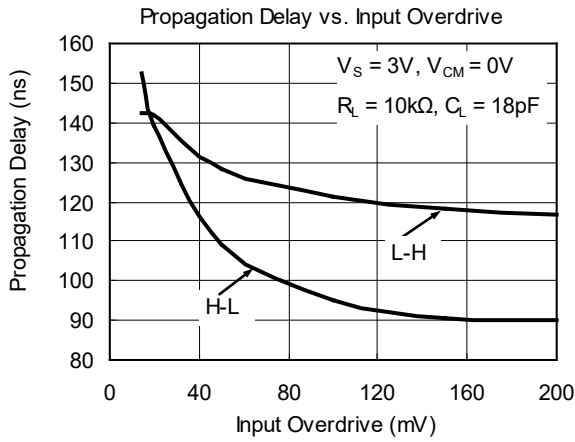

TYPICAL PERFORMANCE CHARACTERISTICS (continued)

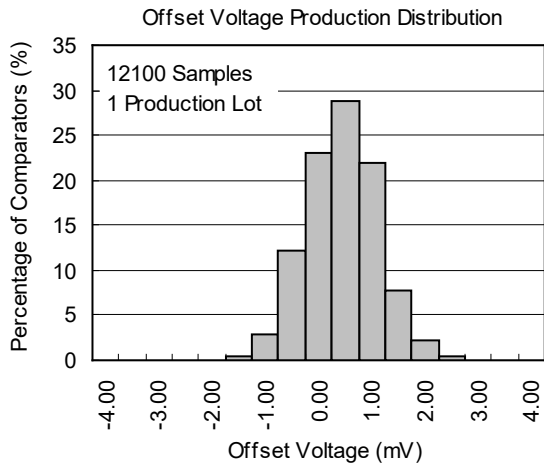

DETAILED DESCRIPTION

The SGM8748 is a single, high speed, low power comparator with internal hysteresis. The device is optimized for low voltage operation from 2.7V to 5.5V single supply. It supports rail-to-rail input and output operation. With 4mA output current, the output voltage swing is within 190mV of the rails without external pull-up or pull-down circuitry. The SGM8748 is suitable for portable equipment. It can be compatible with CMOS and TTL logics.

There are a lot of comparators switched frequently for the linear region as the effect of noise and parasitic parameters, and the condition of this negative situation is when the one input of the comparator tends to reach the other input voltage. In order to ease the effect of noise and parasitic parameter, there is a 2.5mV internal hysteresis inside the comparator.

There are two trip points which are made by the comparator: the trip points when rising edge occurs and the trip points when falling edge occurs. And the gap between two trip points is the hysteresis of the comparator. The offset voltage V_{OS} is defined as the average value of the two trip points. For the condition which two inputs of the comparator are nearly equal, the internal hysteresis will launch to avoid the frequently switching at this case. For the normal comparator other than SGM8748, the users usually use external resistors connected at +IN pin to provide hysteresis, while the internal hysteresis of SGM8748 can provide internal hysteresis without any external component. However, if users need more hysteresis to reject the influence of noise or parasitic parameters, please add the external resistors at +IN pin to increase the hysteresis.

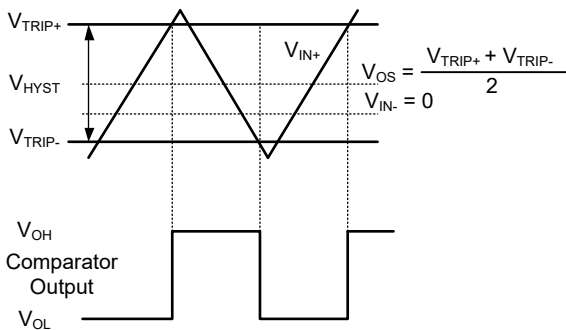

Figure 1. The Waveform for Input and Output, Non-Inverting Input Varied

On the condition shown in Figure 1, the -IN is fixed while +IN is varied, and the corresponding output is shown under the figure of input signal. However, if +IN is fixed while -IN is varied, the output will be inverted.

Output Structure

In Figure 2, the SGM8748 has a push-pull output stage. When output is changed from logic high/low to low/high, the changed sink/source current pulls/pushes output pin to logic low/high. Beginning this transition, larger sink/source current is used to create a high slew rate transit from high/low to low/high. Once the output voltage reaches V_{OL}/V_{OH} , it will reduce the sink/source current to a just right value to maintain the V_{OL}/V_{OH} static condition. This current-driven push-pull output stage will significantly reduce the power consumption in application system.

If low slew rate transition is needed in system design, adjusting the load capacitance will change the slew rate. The heavier capacitive load will slow down the output voltage transition. This feature will be used to reduce the interference generated by fast edge of transition between 1 and 0 in noise-sensitive system.

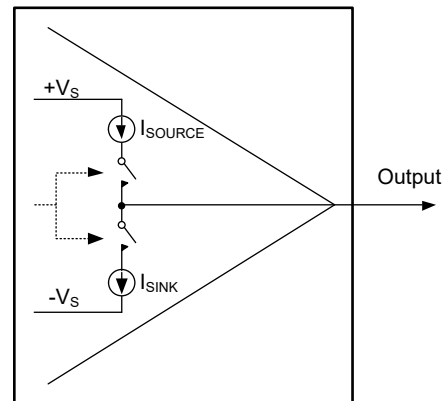

Figure 2. Push-Pull Output Structure

APPLICATION INFORMATION

Application Circuits

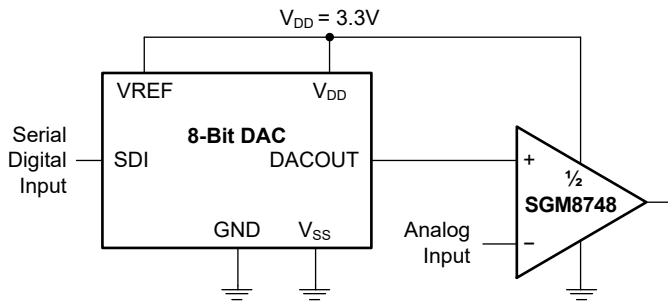

Figure 3. A Threshold Detector Controlled by 8-Bit DAC

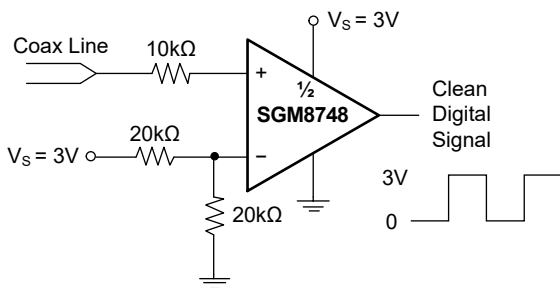

Figure 4. The Application of Line Receiver

Layout and Bypassing

Good power supply decoupling, layout and grounding are very important for SGM8748 to realize the full high-speed capabilities in system, following skills will be used:

- ◆ A 0.1μF to 4.7μF range ceramic capacitor is used to provide good power supply decoupling. This ceramic capacitor must be placed as close to +V_S pin as possible.
- ◆ For grounding, unbroken and low-inductance ground plane is a good choice.
- ◆ For Layout, use short PCB trace to avoid unwanted parasitic feedback around the comparator. SGM8748 must be soldered directly to the PCB and the socket is not recommended.

REVISION HISTORY

NOTE: Page numbers for previous revisions may differ from page numbers in the current version.

AUGUST 2022 – REV.A to REV.A.1	Page
Updated Absolute Maximum Ratings section.....	2

Changes from Original (NOVEMBER 2014) to REV.A	Page
Changed from product preview to production data.....	All

PACKAGE OUTLINE DIMENSIONS

SOIC-8

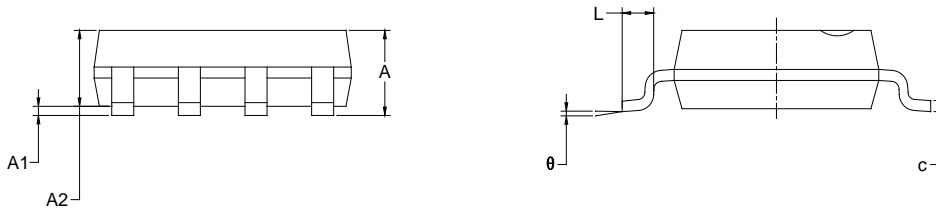
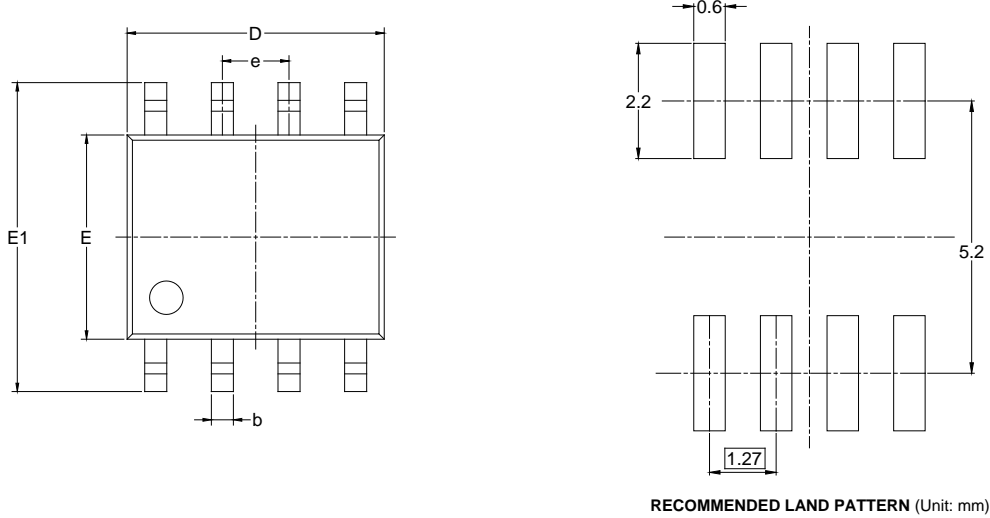

Symbol	Dimensions In Millimeters		Dimensions In Inches	
	MIN	MAX	MIN	MAX
A	1.350	1.750	0.053	0.069
A1	0.100	0.250	0.004	0.010
A2	1.350	1.550	0.053	0.061
b	0.330	0.510	0.013	0.020
c	0.170	0.250	0.006	0.010
D	4.700	5.100	0.185	0.200
E	3.800	4.000	0.150	0.157
E1	5.800	6.200	0.228	0.244
e	1.27 BSC		0.050 BSC	
L	0.400	1.270	0.016	0.050
θ	0°	8°	0°	8°

NOTES:
 1. Body dimensions do not include mode flash or protrusion.
 2. This drawing is subject to change without notice.

PACKAGE OUTLINE DIMENSIONS

MSOP-8

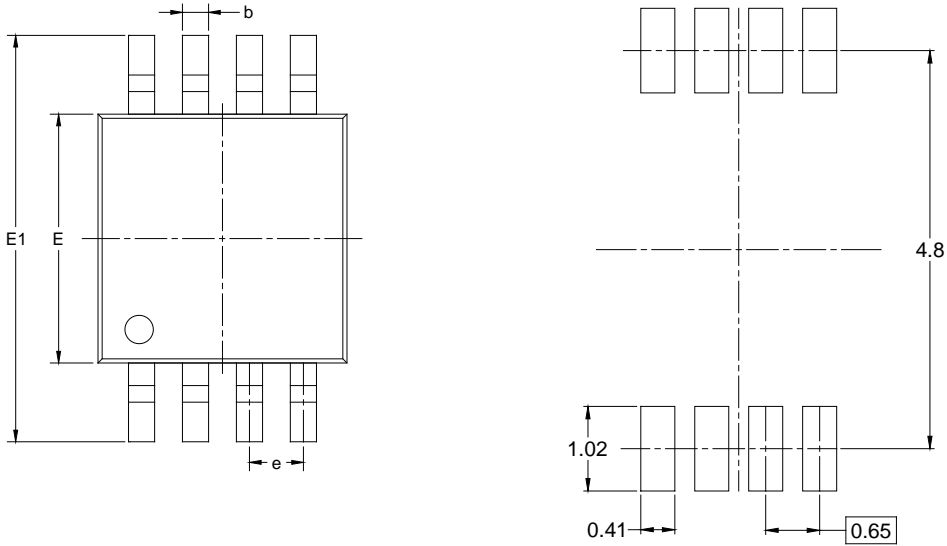

RECOMMENDED LAND PATTERN (Unit: mm)

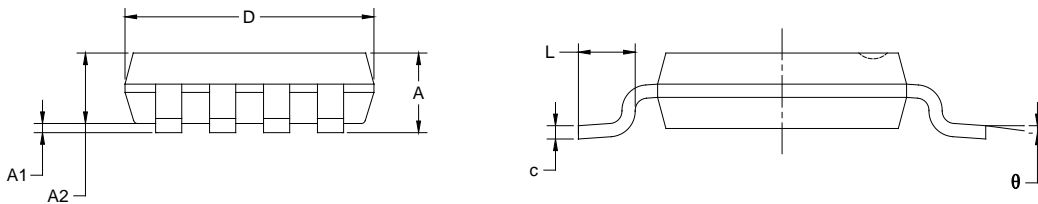

Symbol	Dimensions In Millimeters		Dimensions In Inches	
	MIN	MAX	MIN	MAX
A	0.820	1.100	0.032	0.043
A1	0.020	0.150	0.001	0.006
A2	0.750	0.950	0.030	0.037
b	0.250	0.380	0.010	0.015
c	0.090	0.230	0.004	0.009
D	2.900	3.100	0.114	0.122
E	2.900	3.100	0.114	0.122
E1	4.750	5.050	0.187	0.199
e	0.650 BSC		0.026 BSC	
L	0.400	0.800	0.016	0.031
θ	0°	6°	0°	6°

NOTES:

1. Body dimensions do not include mode flash or protrusion.
2. This drawing is subject to change without notice.

TAPE AND REEL INFORMATION

REEL DIMENSIONS



TAPE DIMENSIONS



NOTE: The picture is only for reference. Please make the object as the standard.

KEY PARAMETER LIST OF TAPE AND REEL

Package Type	Reel Diameter	Reel Width W1 (mm)	A0 (mm)	B0 (mm)	K0 (mm)	P0 (mm)	P1 (mm)	P2 (mm)	W (mm)	Pin1 Quadrant
SOIC-8	13"	12.4	6.40	5.40	2.10	4.0	8.0	2.0	12.0	Q1
MSOP-8	13"	12.4	5.20	3.30	1.50	4.0	8.0	2.0	12.0	Q1

DD0001

PACKAGE INFORMATION

CARTON BOX DIMENSIONS



NOTE: The picture is only for reference. Please make the object as the standard.

KEY PARAMETER LIST OF CARTON BOX

Reel Type	Length (mm)	Width (mm)	Height (mm)	Pizza/Carton
13"	386	280	370	5

DD0002