

GENERAL DESCRIPTION

The SGM9146 is a 4-channel, 6th-order output reconstruction filter which can operate from 3.1V to 5.5V single power supply. It is designed to replace passive LC filters and drivers with an integrated device. One channel is Standard Definition (SD) filter while the rest three channels are configurable between HDi and HDp filters.

The device allows DC- or AC-coupled output. SGM9146 can be DC-coupled or AC-coupled with input video signal to eliminate out-of-band noise, such as the output stage of DAC. Internal clamp and bias circuitry may be used if AC-coupled inputs are required.

The SGM9146 is available in a Green TSSOP-14 package. It operates over an ambient temperature range of -40°C to +85°C.

APPLICATIONS

- Video Recorders
- Video on Demand (VOD)
- Cable and Satellite Set-Top Boxes
- TVs

FEATURES

- **Supply Voltage Range: 3.1V to 5.5V**
- **Three Configurable 6th-Order Filters for 1080i High Definition Mode**
- **1080p High Definition Mode**
- **CVBS Channel has One 6th-Order Standard Definition Filter**
- **Clamp Mode Active with AC-Coupled Inputs for CVBS**
- **Clamp Mode Inactive with DC-Coupled Inputs for CVBS**
- **Bias Mode Active with AC-Coupled Inputs for YPbPr**
- **Bias Mode Inactive with DC-Coupled Inputs for YPbPr**
- **DC-Coupled Outputs Eliminate AC-Coupled Capacitors**
- **-40°C to +85°C Operating Temperature Range**
- **Available in a Green TSSOP-14 Package**

BLOCK DIAGRAM

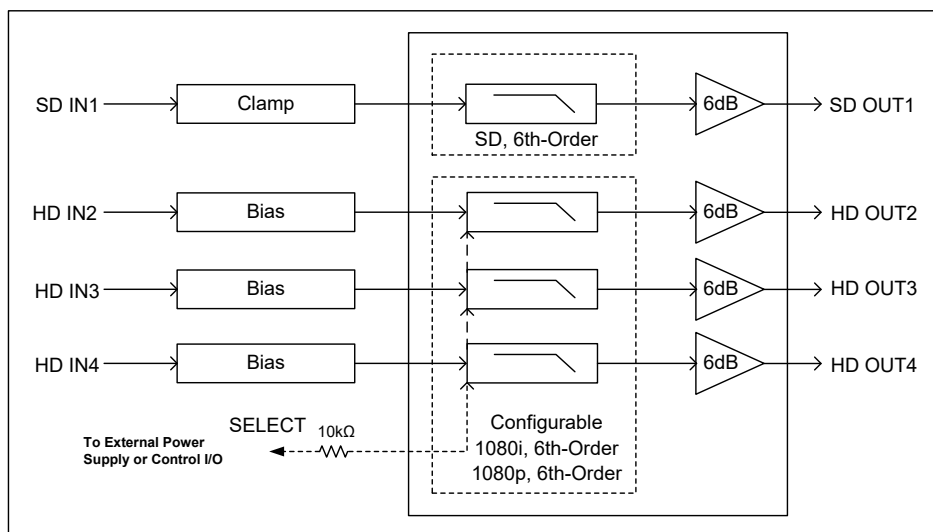

PACKAGE/ORDERING INFORMATION

MODEL	PACKAGE DESCRIPTION	SPECIFIED TEMPERATURE RANGE	ORDERING NUMBER	PACKAGE MARKING	PACKING OPTION
SGM9146	TSSOP-14	-40°C to +85°C	SGM9146YTS14G/TR	SGM9146 YTS14 XXXXX	Tape and Reel, 3000

MARKING INFORMATION

NOTE: XXXXX = Date Code and Vendor Code.

XXXXX

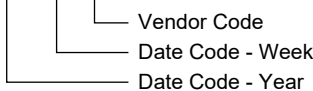

Green (RoHS & HSF): SG Micro Corp defines "Green" to mean Pb-Free (RoHS compatible) and free of halogen substances. If you have additional comments or questions, please contact your SGMICRO representative directly.

Input Voltage..... GND - 0.3V to V_{CC} + 0.3V
 Supply Voltage, V_{CC}..... 6.0V
 Junction Temperature 150°C
 Storage Temperature Range..... -65°C to +150°C
 Lead Temperature (Soldering, 10s) 260°C
 ESD Susceptibility
 HBM..... 8000V
 MM..... 400V

RECOMMENDED OPERATING CONDITIONS

Operating Voltage Range..... 3.1V to 5.5V
 Operating Temperature Range -40°C to +85°C

OVERSTRESS CAUTION

Stresses beyond those listed in Absolute Maximum Ratings may cause permanent damage to the device. Exposure to absolute maximum rating conditions for extended periods may affect reliability. Functional operation of the device at any conditions beyond those indicated in the Recommended Operating Conditions section is not implied.

ESD SENSITIVITY CAUTION

This integrated circuit can be damaged if ESD protections are not considered carefully. SGMICRO recommends that all integrated circuits be handled with appropriate precautions. Failure to observe proper handling and installation procedures can cause damage. ESD damage can range from subtle performance degradation to complete device failure. Precision integrated circuits may be more susceptible to damage because even small parametric changes could cause the device not to meet the published specifications.

DISCLAIMER

SG Micro Corp reserves the right to make any change in circuit design, or specifications without prior notice.

PIN CONFIGURATION

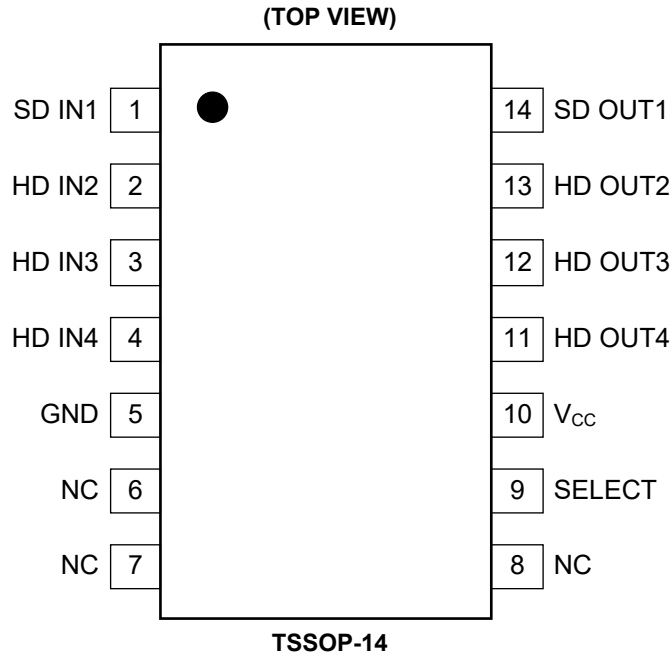

PIN DESCRIPTION

PIN	NAME	FUNCTION
1	SD IN1	Video Input Channel SD. Input is clamp mode.
2	HD IN2	Video Input Channel HD (Pb). Input is bias mode.
3	HD IN3	Video Input Channel HD (Pr). Input is bias mode.
4	HD IN4	Video Input Channel HD (Y). Input is bias mode.
5	GND	Ground.
6, 7, 8	NC	No Internal Connection.
9	SELECT	1080i and 1080p Select. SELECT = "low": 1080i mode is selected. SELECT = "high": 1080p mode is selected.
10	V _{CC}	Power Supply.
11	HD OUT4	Filtered Output Channel HD (Y).
12	HD OUT3	Filtered Output Channel HD (Pr).
13	HD OUT2	Filtered Output Channel HD (Pb).
14	SD OUT1	Filtered Output Channel SD.

ELECTRICAL CHARACTERISTICS

($T_A = +25^\circ\text{C}$, $V_{IN} = 1V_{PP}$, $V_{CC} = 5V$, $R_{SOURCE} = 37.5\Omega$; all inputs are AC-coupled with $0.1\mu\text{F}$; all outputs are AC-coupled with $220\mu\text{F}$ into 150Ω , referenced to 400kHz , unless otherwise noted.)

PARAMETER	CONDITIONS	MIN	TYP	MAX	UNITS
DC Electrical Characteristics					
Operating Voltage Range (V_{CC})		3.1	5	5.5	V
Quiescent Current (I_Q)	$V_{CC} = 5.0V$, no load	1080i	58	76	mA
		1080p	78	99	
Output Level Shift Voltage (V_{OLS})	$V_{IN} = 0V$, no load	SD channel	420	600	mV
		1080i channel	550	700	
Voltage Gain (A_V)	$R_L = 150\Omega$	5.8	6.1	6.35	dB
Output Voltage High Swing	$V_{IN} = 3V$, $R_L = 150\Omega$ to GND		4.8		V
Video Input Voltage Range	Referenced to GND if DC-coupled		1.4		V_{PP}
Power Supply Rejection Ratio (PSRR)	DC (All channels)		50		dB
V_{IH} of SELECT Pin	$V_{CC} = 5.0V$	2.4			V
V_{IL} of SELECT Pin	$V_{CC} = 5.0V$			0.8	V
Standard Definition Mode Electrical Characteristics					
-0.1dB Bandwidth	SD channel		6.4		MHz
-1dB Bandwidth	SD channel		7.6		MHz
-3dB Bandwidth	SD channel		8.5		MHz
Filter Response (Normalized Gain)	SD channel, $f_{IN} = 400\text{kHz}$ to 27MHz		52		dB
Slew Rate	2V output step, 80% to 20%		34		$V/\mu\text{s}$
Differential Gain (DG)	AC-AC coupled, PAL		0.5		%
	AC-DC coupled, PAL		0.4		
Differential Phase (DP)	AC-AC coupled, PAL		1.0		deg
	AC-DC coupled, PAL		1.0		
Group Delay Variation (D/DT)	Difference between 400kHz and 6.5MHz		35		ns
Crosstalk (channel-to-channel)	$V_{OUT} = 1.4V_{PP}$, $f = 1\text{MHz}$		-63		dB
Signal-to-Noise Ratio (SNR)	100kHz to 5MHz		-66		dB
Fall Time	2V output step, 80% to 20%		34		ns
Rise Time	2V output step, 80% to 20%		36		ns
Chroma Luma Gain (CLG_{SD})	$f = 3.58\text{MHz}$ (Referenced to SD_{IN} at 400kHz)		102		%
Chroma Luma Delay (CLD_{SD})	$f = 3.58\text{MHz}$ (Referenced to SD_{IN} at 400kHz)		8		ns

ELECTRICAL CHARACTERISTICS (continued)

($T_A = +25^\circ\text{C}$, $V_{IN} = 1V_{PP}$, $V_{CC} = 5V$, $R_{SOURCE} = 37.5\Omega$; all inputs are AC-coupled with $0.1\mu\text{F}$; all outputs are AC-coupled with $220\mu\text{F}$ into 150Ω , referenced to 400kHz , unless otherwise noted.)

PARAMETER	CONDITIONS	MIN	TYP	MAX	UNITS
1080i High Definition Mode Electrical Characteristics					
-0.1dB Bandwidth	$R_L = 150\Omega$		32		MHz
-1dB Bandwidth	$R_L = 150\Omega$		39		MHz
-3dB Bandwidth	$R_L = 150\Omega$		46		MHz
Filter Response (Normalized Gain)	$f_{IN} = 400\text{kHz}$ to 74.25MHz		25		dB
Slew Rate	2V output step, 80% to 20%		190		V/ μs
Group Delay Variation (D/DT)	Difference between 400kHz and 26MHz		3.5		ns
Crosstalk (channel-to-channel)	$V_{OUT} = 1.4V_{PP}$, $f = 1\text{MHz}$		-63		dB
Fall Time	2V output step, 80% to 20%		6.2		ns
Rise Time	2V output step, 80% to 20%		6.2		ns
1080p High Definition Mode Electrical Characteristics					
-0.1dB Bandwidth	$R_L = 150\Omega$		78		MHz
-1dB Bandwidth	$R_L = 150\Omega$		86		MHz
-3dB Bandwidth	$R_L = 150\Omega$		98		MHz
Filter Response (Normalized Gain)	$f_{IN} = 400\text{kHz}$ to 148MHz		22		dB
Slew Rate	2V output step, 80% to 20%		340		V/ μs
Group Delay Variation (D/DT)	Difference between 400kHz and 70MHz		5.3		ns
Crosstalk (channel-to-channel)	$V_{OUT} = 1.4V_{PP}$, $f = 1\text{MHz}$		-64		dB
Fall Time	2V output step, 80% to 20%		3.3		ns
Rise Time	2V output step, 80% to 20%		3.6		ns

TYPICAL PERFORMANCE CHARACTERISTICS

$T_A = +25^\circ\text{C}$, $V_{IN} = 1V_{PP}$, $V_{CC} = 5V$, $R_{SOURCE} = 37.5\Omega$; all inputs are AC-coupled with $0.1\mu\text{F}$; all outputs are AC-coupled with $220\mu\text{F}$ into 150Ω , referenced to 400kHz , unless otherwise noted.

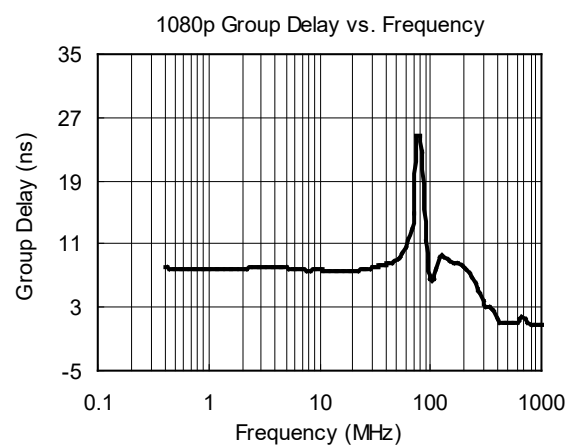
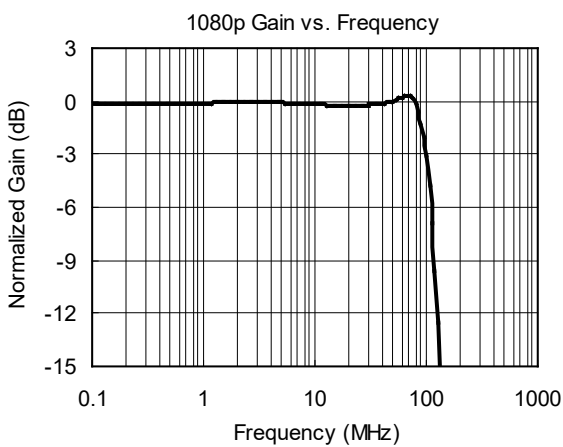
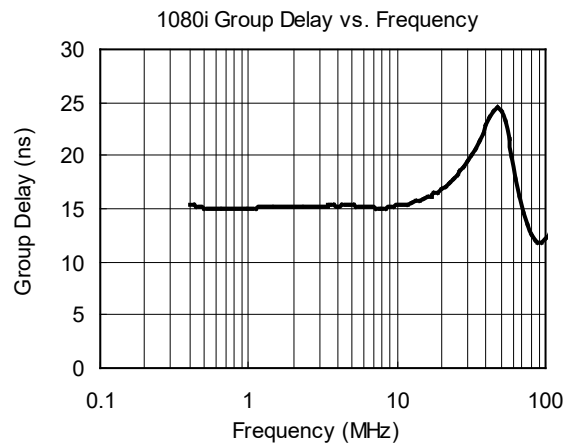
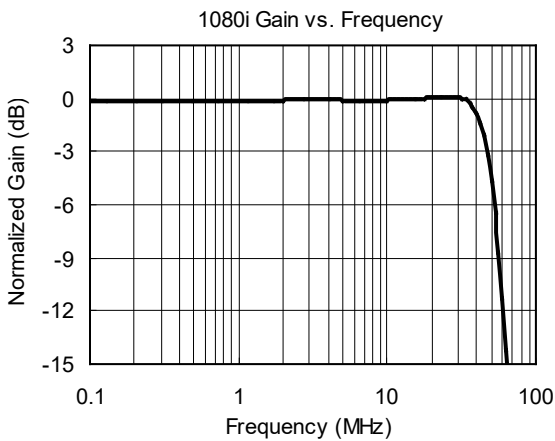
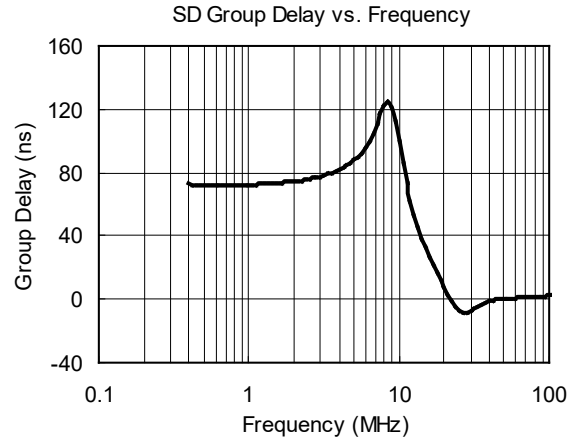
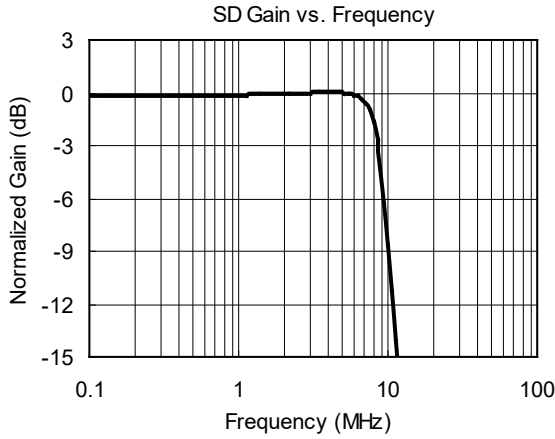

TYPICAL PERFORMANCE CHARACTERISTICS

$T_A = +25^\circ\text{C}$, $V_{IN} = 1V_{PP}$, $V_{CC} = 5V$, $R_{SOURCE} = 37.5\Omega$; all inputs are AC-coupled with $0.1\mu\text{F}$; all outputs are AC-coupled with $220\mu\text{F}$ into 150Ω , referenced to 400kHz, unless otherwise noted.

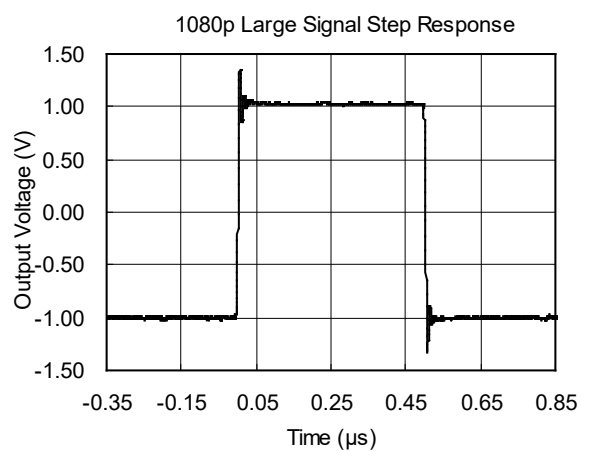
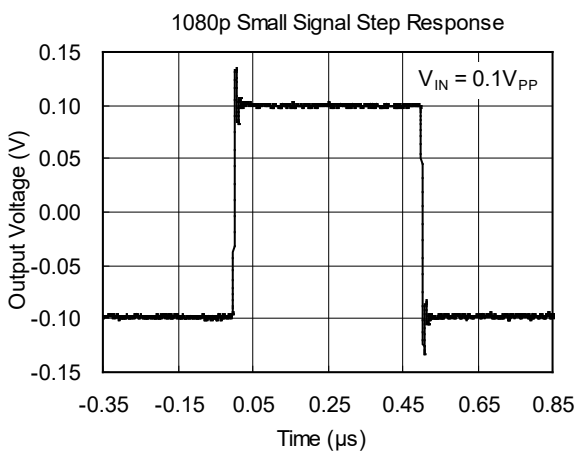
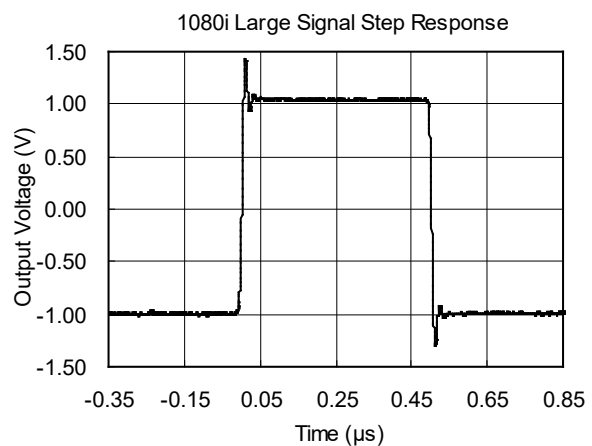
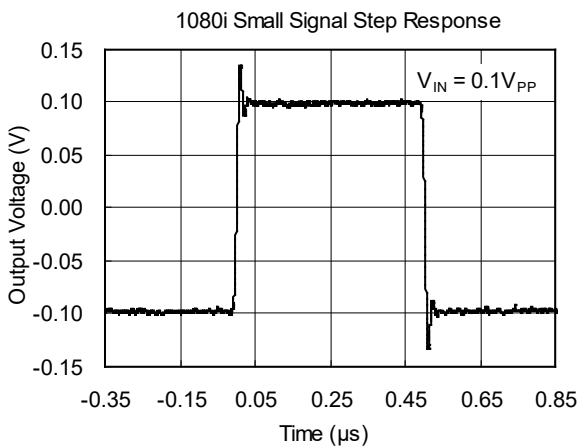
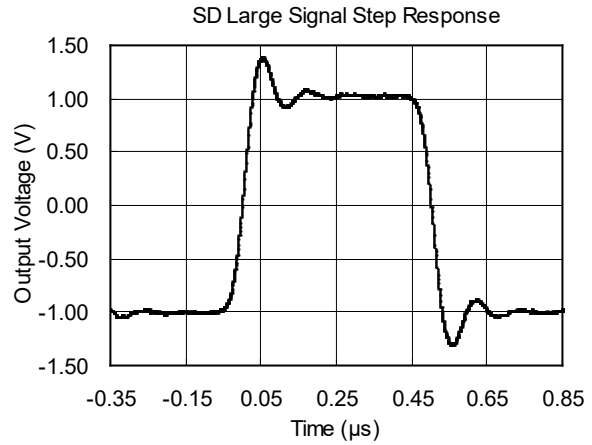
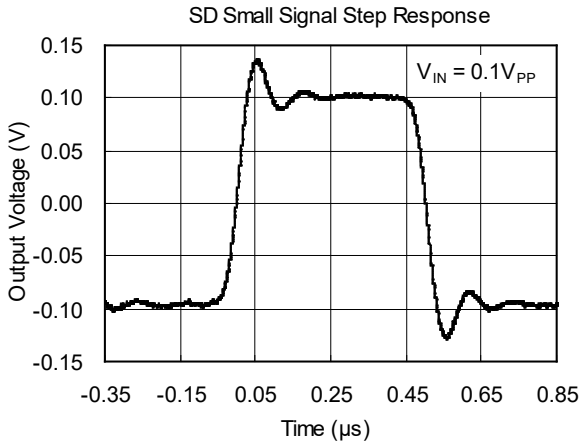

PACKAGE OUTLINE DIMENSIONS

TSSOP-14

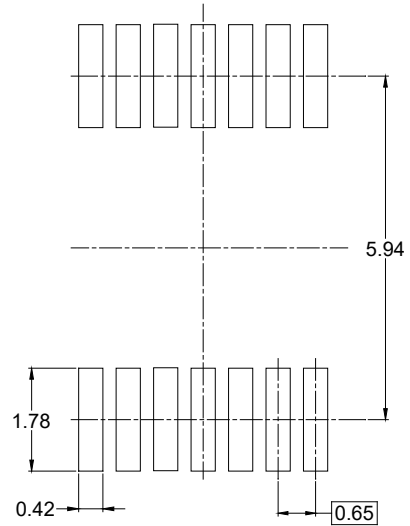
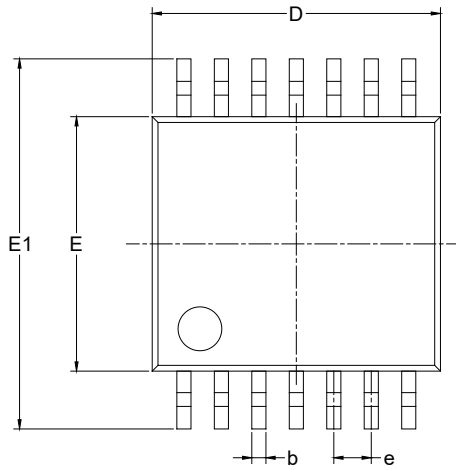

RECOMMENDED LAND PATTERN (Unit: mm)

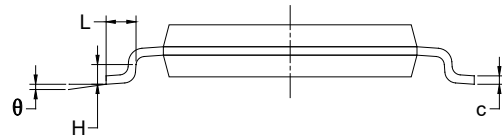
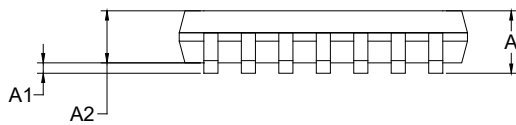

Symbol	Dimensions In Millimeters		Dimensions In Inches	
	MIN	MAX	MIN	MAX
A		1.100		0.043
A1	0.050	0.150	0.002	0.006
A2	0.800	1.000	0.031	0.039
b	0.190	0.300	0.007	0.012
c	0.090	0.200	0.004	0.008
D	4.900	5.100	0.193	0.201
E	4.300	4.500	0.169	0.177
E1	6.250	6.550	0.246	0.258
e	0.650 BSC		0.026 BSC	
L	0.500	0.700	0.02	0.028
H	0.25 TYP		0.01 TYP	
θ	1°	7°	1°	7°

NOTES:

1. Body dimensions do not include mode flash or protrusion.
2. This drawing is subject to change without notice.

PACKAGE INFORMATION

TAPE AND REEL INFORMATION

REEL DIMENSIONS



TAPE DIMENSIONS



NOTE: The picture is only for reference. Please make the object as the standard.

KEY PARAMETER LIST OF TAPE AND REEL

Package Type	Reel Diameter	Reel Width W1 (mm)	A0 (mm)	B0 (mm)	K0 (mm)	P0 (mm)	P1 (mm)	P2 (mm)	W (mm)	Pin1 Quadrant
TSSOP-14	13"	12.4	6.95	5.60	1.20	4.0	8.0	2.0	12.0	Q1

DD0001

PACKAGE INFORMATION

CARTON BOX DIMENSIONS



NOTE: The picture is only for reference. Please make the object as the standard.

KEY PARAMETER LIST OF CARTON BOX

Reel Type	Length (mm)	Width (mm)	Height (mm)	Pizza/Carton
13"	386	280	370	5

DD0002