

GENERAL DESCRIPTION

The SGM41100W is designed for primary protection of Li-Ion/polymer rechargeable cells. The product integrates all the protections required for safe operation of polymer rechargeable cells. The device is packaged in a tiny and thin package. Its small solution size leaves more space for fitting the battery cell into a given cavity for small size wearable devices.

The SGM41100W integrates all the protections and the required low on-resistance disconnect switch on one die. The protection features include charge and discharge protection, detection and protection of a cell in charge over-voltage, charge over-current, discharge under-voltage, discharge over-current, prohibit charge and discharge when battery lower than certain voltage and battery under-voltage. The product also disconnects the battery pack in the case of deep discharge.

The SGM41100W operates in -40°C to $+85^{\circ}\text{C}$ temperature range, and is in a thin and low profile UTDFN-1.5x2-6L package. This package with a nominal height of 0.5mm is convenient for small cell packing designs.

FEATURES

- Ultra-Compact Protection Solution
- Pass Resistance: 42mΩ (TYP)
- Operation Current: 1.1μA (TYP)
- Factory Programmable OVP Threshold Options
4.20V to 4.575V with 0.025V per Step
- Charge/Discharge Over-Current Protection
3 Thresholds Combination Options
- Battery Under-Voltage Protection
2.6V/2.7V/2.8V/3.0V Options
- 50nA Deep Discharge Shutdown
- Input Surge Clamping
- Input Over-Voltage Safe
- Load Short-Circuit Safe
- Reverse Polarity Battery Safe
- Input Reversed-Attaching Safe
- Battery Pack Paralleling Safe
- Locked-Off for Delivery/Assembly
- Available in a Green UTDFN-1.5x2-6L Package

APPLICATIONS

- IoT Gadgets
- Wearable Devices
- Battery Packs

TYPICAL APPLICATION

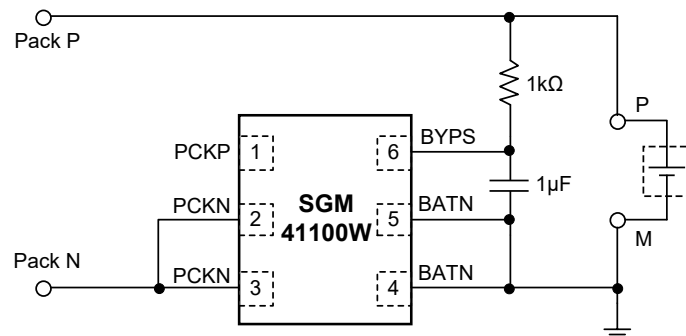

NOTE: The short-circuit of both ends (P and M) of the battery should be avoided during the battery assembly process.

Figure 1. Typical Application Circuit

PACKAGE/ORDERING INFORMATION

MODEL	PACKAGE DESCRIPTION	SPECIFIED TEMPERATURE RANGE	ORDERING NUMBER	PACKAGE MARKING	PACKING OPTION
SGM41100W-420M01	UTDFN-1.5×2-6L	-40°C to +85°C	SGM41100W-420M01YUDT6G/TR	GAN XXX	Tape and Reel, 3000
SGM41100W-420M02	UTDFN-1.5×2-6L	-40°C to +85°C	SGM41100W-420M02YUDT6G/TR	GAP XXX	Tape and Reel, 3000
SGM41100W-420M04	UTDFN-1.5×2-6L	-40°C to +85°C	SGM41100W-420M04YUDT6G/TR	GAQ XXX	Tape and Reel, 3000
SGM41100W-420N01	UTDFN-1.5×2-6L	-40°C to +85°C	SGM41100W-420N01YUDT6G/TR	GAR XXX	Tape and Reel, 3000
SGM41100W-420N02	UTDFN-1.5×2-6L	-40°C to +85°C	SGM41100W-420N02YUDT6G/TR	GAS XXX	Tape and Reel, 3000
SGM41100W-420N04	UTDFN-1.5×2-6L	-40°C to +85°C	SGM41100W-420N04YUDT6G/TR	GAT XXX	Tape and Reel, 3000
SGM41100W-420O01	UTDFN-1.5×2-6L	-40°C to +85°C	SGM41100W-420O01YUDT6G/TR	GAU XXX	Tape and Reel, 3000
SGM41100W-420O02	UTDFN-1.5×2-6L	-40°C to +85°C	SGM41100W-420O02YUDT6G/TR	GAV XXX	Tape and Reel, 3000
SGM41100W-420O04	UTDFN-1.5×2-6L	-40°C to +85°C	SGM41100W-420O04YUDT6G/TR	GAW XXX	Tape and Reel, 3000
SGM41100W-420P01	UTDFN-1.5×2-6L	-40°C to +85°C	SGM41100W-420P01YUDT6G/TR	GAX XXX	Tape and Reel, 3000
SGM41100W-420P02	UTDFN-1.5×2-6L	-40°C to +85°C	SGM41100W-420P02YUDT6G/TR	GAY XXX	Tape and Reel, 3000
SGM41100W-420P04	UTDFN-1.5×2-6L	-40°C to +85°C	SGM41100W-420P04YUDT6G/TR	GAZ XXX	Tape and Reel, 3000
SGM41100W-423M01	UTDFN-1.5×2-6L	-40°C to +85°C	SGM41100W-423M01YUDT6G/TR	GBG XXX	Tape and Reel, 3000
SGM41100W-423M02	UTDFN-1.5×2-6L	-40°C to +85°C	SGM41100W-423M02YUDT6G/TR	GBH XXX	Tape and Reel, 3000
SGM41100W-423M04	UTDFN-1.5×2-6L	-40°C to +85°C	SGM41100W-423M04YUDT6G/TR	GBI XXX	Tape and Reel, 3000
SGM41100W-423N01	UTDFN-1.5×2-6L	-40°C to +85°C	SGM41100W-423N01YUDT6G/TR	GBJ XXX	Tape and Reel, 3000
SGM41100W-423N02	UTDFN-1.5×2-6L	-40°C to +85°C	SGM41100W-423N02YUDT6G/TR	GBK XXX	Tape and Reel, 3000
SGM41100W-423N04	UTDFN-1.5×2-6L	-40°C to +85°C	SGM41100W-423N04YUDT6G/TR	GBL XXX	Tape and Reel, 3000
SGM41100W-423O01	UTDFN-1.5×2-6L	-40°C to +85°C	SGM41100W-423O01YUDT6G/TR	GBM XXX	Tape and Reel, 3000
SGM41100W-423O02	UTDFN-1.5×2-6L	-40°C to +85°C	SGM41100W-423O02YUDT6G/TR	GBN XXX	Tape and Reel, 3000
SGM41100W-423O04	UTDFN-1.5×2-6L	-40°C to +85°C	SGM41100W-423O04YUDT6G/TR	GBP XXX	Tape and Reel, 3000
SGM41100W-423P01	UTDFN-1.5×2-6L	-40°C to +85°C	SGM41100W-423P01YUDT6G/TR	GBQ XXX	Tape and Reel, 3000
SGM41100W-423P02	UTDFN-1.5×2-6L	-40°C to +85°C	SGM41100W-423P02YUDT6G/TR	GBR XXX	Tape and Reel, 3000
SGM41100W-423P04	UTDFN-1.5×2-6L	-40°C to +85°C	SGM41100W-423P04YUDT6G/TR	GBS XXX	Tape and Reel, 3000
SGM41100W-425M01	UTDFN-1.5×2-6L	-40°C to +85°C	SGM41100W-425M01YUDT6G/TR	GBT XXX	Tape and Reel, 3000
SGM41100W-425M02	UTDFN-1.5×2-6L	-40°C to +85°C	SGM41100W-425M02YUDT6G/TR	GBU XXX	Tape and Reel, 3000

SGM41100W

True Monolithic Li-Ion/Polymer Battery Protector in Tiny Thin Package

MODEL	PACKAGE DESCRIPTION	SPECIFIED TEMPERATURE RANGE	ORDERING NUMBER	PACKAGE MARKING	PACKING OPTION
SGM41100W-425M04	UTDFN-1.5×2-6L	-40°C to +85°C	SGM41100W-425M04YUDT6G/TR	GBV XXX	Tape and Reel, 3000
SGM41100W-425N01	UTDFN-1.5×2-6L	-40°C to +85°C	SGM41100W-425N01YUDT6G/TR	GBW XXX	Tape and Reel, 3000
SGM41100W-425N02	UTDFN-1.5×2-6L	-40°C to +85°C	SGM41100W-425N02YUDT6G/TR	GBX XXX	Tape and Reel, 3000
SGM41100W-425N04	UTDFN-1.5×2-6L	-40°C to +85°C	SGM41100W-425N04YUDT6G/TR	GBY XXX	Tape and Reel, 3000
SGM41100W-425O01	UTDFN-1.5×2-6L	-40°C to +85°C	SGM41100W-425O01YUDT6G/TR	GBZ XXX	Tape and Reel, 3000
SGM41100W-425O02	UTDFN-1.5×2-6L	-40°C to +85°C	SGM41100W-425O02YUDT6G/TR	GCG XXX	Tape and Reel, 3000
SGM41100W-425O04	UTDFN-1.5×2-6L	-40°C to +85°C	SGM41100W-425O04YUDT6G/TR	GCH XXX	Tape and Reel, 3000
SGM41100W-425P01	UTDFN-1.5×2-6L	-40°C to +85°C	SGM41100W-425P01YUDT6G/TR	GCI XXX	Tape and Reel, 3000
SGM41100W-425P02	UTDFN-1.5×2-6L	-40°C to +85°C	SGM41100W-425P02YUDT6G/TR	GCJ XXX	Tape and Reel, 3000
SGM41100W-425P04	UTDFN-1.5×2-6L	-40°C to +85°C	SGM41100W-425P04YUDT6G/TR	GCK XXX	Tape and Reel, 3000
SGM41100W-428M01	UTDFN-1.5×2-6L	-40°C to +85°C	SGM41100W-428M01YUDT6G/TR	GCL XXX	Tape and Reel, 3000
SGM41100W-428M02	UTDFN-1.5×2-6L	-40°C to +85°C	SGM41100W-428M02YUDT6G/TR	GCM XXX	Tape and Reel, 3000
SGM41100W-428M04	UTDFN-1.5×2-6L	-40°C to +85°C	SGM41100W-428M04YUDT6G/TR	GCN XXX	Tape and Reel, 3000
SGM41100W-428N01	UTDFN-1.5×2-6L	-40°C to +85°C	SGM41100W-428N01YUDT6G/TR	GCP XXX	Tape and Reel, 3000
SGM41100W-428N02	UTDFN-1.5×2-6L	-40°C to +85°C	SGM41100W-428N02YUDT6G/TR	GCQ XXX	Tape and Reel, 3000
SGM41100W-428N04	UTDFN-1.5×2-6L	-40°C to +85°C	SGM41100W-428N04YUDT6G/TR	GCR XXX	Tape and Reel, 3000
SGM41100W-428O01	UTDFN-1.5×2-6L	-40°C to +85°C	SGM41100W-428O01YUDT6G/TR	GCS XXX	Tape and Reel, 3000
SGM41100W-428O02	UTDFN-1.5×2-6L	-40°C to +85°C	SGM41100W-428O02YUDT6G/TR	GCT XXX	Tape and Reel, 3000
SGM41100W-428O04	UTDFN-1.5×2-6L	-40°C to +85°C	SGM41100W-428O04YUDT6G/TR	GCU XXX	Tape and Reel, 3000
SGM41100W-428P01	UTDFN-1.5×2-6L	-40°C to +85°C	SGM41100W-428P01YUDT6G/TR	GCV XXX	Tape and Reel, 3000
SGM41100W-428P02	UTDFN-1.5×2-6L	-40°C to +85°C	SGM41100W-428P02YUDT6G/TR	GCW XXX	Tape and Reel, 3000
SGM41100W-428P04	UTDFN-1.5×2-6L	-40°C to +85°C	SGM41100W-428P04YUDT6G/TR	GCX XXX	Tape and Reel, 3000
SGM41100W-430M01	UTDFN-1.5×2-6L	-40°C to +85°C	SGM41100W-430M01YUDT6G/TR	GCY XXX	Tape and Reel, 3000
SGM41100W-430M02	UTDFN-1.5×2-6L	-40°C to +85°C	SGM41100W-430M02YUDT6G/TR	GCZ XXX	Tape and Reel, 3000
SGM41100W-430M04	UTDFN-1.5×2-6L	-40°C to +85°C	SGM41100W-430M04YUDT6G/TR	GD1 XXX	Tape and Reel, 3000
SGM41100W-430N01	UTDFN-1.5×2-6L	-40°C to +85°C	SGM41100W-430N01YUDT6G/TR	GD2 XXX	Tape and Reel, 3000
SGM41100W-430N02	UTDFN-1.5×2-6L	-40°C to +85°C	SGM41100W-430N02YUDT6G/TR	GDG XXX	Tape and Reel, 3000

SGM41100W

True Monolithic Li-Ion/Polymer Battery Protector in Tiny Thin Package

MODEL	PACKAGE DESCRIPTION	SPECIFIED TEMPERATURE RANGE	ORDERING NUMBER	PACKAGE MARKING	PACKING OPTION
SGM41100W-430N04	UTDFN-1.5×2-6L	-40°C to +85°C	SGM41100W-430N04YUDT6G/TR	GDH XXX	Tape and Reel, 3000
SGM41100W-430O01	UTDFN-1.5×2-6L	-40°C to +85°C	SGM41100W-430O01YUDT6G/TR	GDI XXX	Tape and Reel, 3000
SGM41100W-430O02	UTDFN-1.5×2-6L	-40°C to +85°C	SGM41100W-430O02YUDT6G/TR	GDJ XXX	Tape and Reel, 3000
SGM41100W-430O04	UTDFN-1.5×2-6L	-40°C to +85°C	SGM41100W-430O04YUDT6G/TR	OUB XXX	Tape and Reel, 3000
SGM41100W-430P01	UTDFN-1.5×2-6L	-40°C to +85°C	SGM41100W-430P01YUDT6G/TR	GDK XXX	Tape and Reel, 3000
SGM41100W-430P02	UTDFN-1.5×2-6L	-40°C to +85°C	SGM41100W-430P02YUDT6G/TR	GDL XXX	Tape and Reel, 3000
SGM41100W-430P04	UTDFN-1.5×2-6L	-40°C to +85°C	SGM41100W-430P04YUDT6G/TR	OUC XXX	Tape and Reel, 3000
SGM41100W-433M01	UTDFN-1.5×2-6L	-40°C to +85°C	SGM41100W-433M01YUDT6G/TR	GDM XXX	Tape and Reel, 3000
SGM41100W-433M02	UTDFN-1.5×2-6L	-40°C to +85°C	SGM41100W-433M02YUDT6G/TR	GDN XXX	Tape and Reel, 3000
SGM41100W-433M04	UTDFN-1.5×2-6L	-40°C to +85°C	SGM41100W-433M04YUDT6G/TR	GDP XXX	Tape and Reel, 3000
SGM41100W-433N01	UTDFN-1.5×2-6L	-40°C to +85°C	SGM41100W-433N01YUDT6G/TR	GDQ XXX	Tape and Reel, 3000
SGM41100W-433N02	UTDFN-1.5×2-6L	-40°C to +85°C	SGM41100W-433N02YUDT6G/TR	GDR XXX	Tape and Reel, 3000
SGM41100W-433N04	UTDFN-1.5×2-6L	-40°C to +85°C	SGM41100W-433N04YUDT6G/TR	GDS XXX	Tape and Reel, 3000
SGM41100W-433O01	UTDFN-1.5×2-6L	-40°C to +85°C	SGM41100W-433O01YUDT6G/TR	GDT XXX	Tape and Reel, 3000
SGM41100W-433O02	UTDFN-1.5×2-6L	-40°C to +85°C	SGM41100W-433O02YUDT6G/TR	GDU XXX	Tape and Reel, 3000
SGM41100W-433O04	UTDFN-1.5×2-6L	-40°C to +85°C	SGM41100W-433O04YUDT6G/TR	GDV XXX	Tape and Reel, 3000
SGM41100W-433P01	UTDFN-1.5×2-6L	-40°C to +85°C	SGM41100W-433P01YUDT6G/TR	GDW XXX	Tape and Reel, 3000
SGM41100W-433P02	UTDFN-1.5×2-6L	-40°C to +85°C	SGM41100W-433P02YUDT6G/TR	GDX XXX	Tape and Reel, 3000
SGM41100W-433P04	UTDFN-1.5×2-6L	-40°C to +85°C	SGM41100W-433P04YUDT6G/TR	GDY XXX	Tape and Reel, 3000
SGM41100W-435M01	UTDFN-1.5×2-6L	-40°C to +85°C	SGM41100W-435M01YUDT6G/TR	GDZ XXX	Tape and Reel, 3000
SGM41100W-435M02	UTDFN-1.5×2-6L	-40°C to +85°C	SGM41100W-435M02YUDT6G/TR	GE1 XXX	Tape and Reel, 3000
SGM41100W-435M04	UTDFN-1.5×2-6L	-40°C to +85°C	SGM41100W-435M04YUDT6G/TR	GEG XXX	Tape and Reel, 3000
SGM41100W-435N01	UTDFN-1.5×2-6L	-40°C to +85°C	SGM41100W-435N01YUDT6G/TR	GEH XXX	Tape and Reel, 3000
SGM41100W-435N02	UTDFN-1.5×2-6L	-40°C to +85°C	SGM41100W-435N02YUDT6G/TR	GEI XXX	Tape and Reel, 3000
SGM41100W-435N04	UTDFN-1.5×2-6L	-40°C to +85°C	SGM41100W-435N04YUDT6G/TR	GEJ XXX	Tape and Reel, 3000
SGM41100W-435O01	UTDFN-1.5×2-6L	-40°C to +85°C	SGM41100W-435O01YUDT6G/TR	GEK XXX	Tape and Reel, 3000
SGM41100W-435O02	UTDFN-1.5×2-6L	-40°C to +85°C	SGM41100W-435O02YUDT6G/TR	GEL XXX	Tape and Reel, 3000

SGM41100W

True Monolithic Li-Ion/Polymer Battery Protector in Tiny Thin Package

MODEL	PACKAGE DESCRIPTION	SPECIFIED TEMPERATURE RANGE	ORDERING NUMBER	PACKAGE MARKING	PACKING OPTION
SGM41100W-435O04	UTDFN-1.5×2-6L	-40°C to +85°C	SGM41100W-435O04YUDT6G/TR	ODU XXX	Tape and Reel, 3000
SGM41100W-435P01	UTDFN-1.5×2-6L	-40°C to +85°C	SGM41100W-435P01YUDT6G/TR	GEM XXX	Tape and Reel, 3000
SGM41100W-435P02	UTDFN-1.5×2-6L	-40°C to +85°C	SGM41100W-435P02YUDT6G/TR	GEN XXX	Tape and Reel, 3000
SGM41100W-435P04	UTDFN-1.5×2-6L	-40°C to +85°C	SGM41100W-435P04YUDT6G/TR	OUE XXX	Tape and Reel, 3000
SGM41100W-438M01	UTDFN-1.5×2-6L	-40°C to +85°C	SGM41100W-438M01YUDT6G/TR	GEP XXX	Tape and Reel, 3000
SGM41100W-438M02	UTDFN-1.5×2-6L	-40°C to +85°C	SGM41100W-438M02YUDT6G/TR	GEQ XXX	Tape and Reel, 3000
SGM41100W-438M04	UTDFN-1.5×2-6L	-40°C to +85°C	SGM41100W-438M04YUDT6G/TR	GER XXX	Tape and Reel, 3000
SGM41100W-438N01	UTDFN-1.5×2-6L	-40°C to +85°C	SGM41100W-438N01YUDT6G/TR	GES XXX	Tape and Reel, 3000
SGM41100W-438N02	UTDFN-1.5×2-6L	-40°C to +85°C	SGM41100W-438N02YUDT6G/TR	GET XXX	Tape and Reel, 3000
SGM41100W-438N04	UTDFN-1.5×2-6L	-40°C to +85°C	SGM41100W-438N04YUDT6G/TR	GEU XXX	Tape and Reel, 3000
SGM41100W-438O01	UTDFN-1.5×2-6L	-40°C to +85°C	SGM41100W-438O01YUDT6G/TR	GEV XXX	Tape and Reel, 3000
SGM41100W-438O02	UTDFN-1.5×2-6L	-40°C to +85°C	SGM41100W-438O02YUDT6G/TR	GEW XXX	Tape and Reel, 3000
SGM41100W-438O04	UTDFN-1.5×2-6L	-40°C to +85°C	SGM41100W-438O04YUDT6G/TR	GEX XXX	Tape and Reel, 3000
SGM41100W-438P01	UTDFN-1.5×2-6L	-40°C to +85°C	SGM41100W-438P01YUDT6G/TR	GEY XXX	Tape and Reel, 3000
SGM41100W-438P02	UTDFN-1.5×2-6L	-40°C to +85°C	SGM41100W-438P02YUDT6G/TR	GEZ XXX	Tape and Reel, 3000
SGM41100W-438P04	UTDFN-1.5×2-6L	-40°C to +85°C	SGM41100W-438P04YUDT6G/TR	GFG XXX	Tape and Reel, 3000
SGM41100W-440M01	UTDFN-1.5×2-6L	-40°C to +85°C	SGM41100W-440M01YUDT6G/TR	GFH XXX	Tape and Reel, 3000
SGM41100W-440M02	UTDFN-1.5×2-6L	-40°C to +85°C	SGM41100W-440M02YUDT6G/TR	GFI XXX	Tape and Reel, 3000
SGM41100W-440M04	UTDFN-1.5×2-6L	-40°C to +85°C	SGM41100W-440M04YUDT6G/TR	GFJ XXX	Tape and Reel, 3000
SGM41100W-440N01	UTDFN-1.5×2-6L	-40°C to +85°C	SGM41100W-440N01YUDT6G/TR	GFK XXX	Tape and Reel, 3000
SGM41100W-440N02	UTDFN-1.5×2-6L	-40°C to +85°C	SGM41100W-440N02YUDT6G/TR	GFL XXX	Tape and Reel, 3000
SGM41100W-440N04	UTDFN-1.5×2-6L	-40°C to +85°C	SGM41100W-440N04YUDT6G/TR	GFM XXX	Tape and Reel, 3000
SGM41100W-440O01	UTDFN-1.5×2-6L	-40°C to +85°C	SGM41100W-440O01YUDT6G/TR	GFN XXX	Tape and Reel, 3000
SGM41100W-440O02	UTDFN-1.5×2-6L	-40°C to +85°C	SGM41100W-440O02YUDT6G/TR	GFP XXX	Tape and Reel, 3000
SGM41100W-440O04	UTDFN-1.5×2-6L	-40°C to +85°C	SGM41100W-440O04YUDT6G/TR	GFQ XXX	Tape and Reel, 3000
SGM41100W-440P01	UTDFN-1.5×2-6L	-40°C to +85°C	SGM41100W-440P01YUDT6G/TR	GFR XXX	Tape and Reel, 3000
SGM41100W-440P02	UTDFN-1.5×2-6L	-40°C to +85°C	SGM41100W-440P02YUDT6G/TR	GFS XXX	Tape and Reel, 3000

SGM41100W

True Monolithic Li-Ion/Polymer Battery Protector in Tiny Thin Package

MODEL	PACKAGE DESCRIPTION	SPECIFIED TEMPERATURE RANGE	ORDERING NUMBER	PACKAGE MARKING	PACKING OPTION
SGM41100W-440P04	UTDFN-1.5×2-6L	-40°C to +85°C	SGM41100W-440P04YUDT6G/TR	GFT XXX	Tape and Reel, 3000
SGM41100W-443M01	UTDFN-1.5×2-6L	-40°C to +85°C	SGM41100W-443M01YUDT6G/TR	GFU XXX	Tape and Reel, 3000
SGM41100W-443M02	UTDFN-1.5×2-6L	-40°C to +85°C	SGM41100W-443M02YUDT6G/TR	GFV XXX	Tape and Reel, 3000
SGM41100W-443M04	UTDFN-1.5×2-6L	-40°C to +85°C	SGM41100W-443M04YUDT6G/TR	GFW XXX	Tape and Reel, 3000
SGM41100W-443N01	UTDFN-1.5×2-6L	-40°C to +85°C	SGM41100W-443N01YUDT6G/TR	GFX XXX	Tape and Reel, 3000
SGM41100W-443N02	UTDFN-1.5×2-6L	-40°C to +85°C	SGM41100W-443N02YUDT6G/TR	GFY XXX	Tape and Reel, 3000
SGM41100W-443N04	UTDFN-1.5×2-6L	-40°C to +85°C	SGM41100W-443N04YUDT6G/TR	GFZ XXX	Tape and Reel, 3000
SGM41100W-443O01	UTDFN-1.5×2-6L	-40°C to +85°C	SGM41100W-443O01YUDT6G/TR	GGA XXX	Tape and Reel, 3000
SGM41100W-443O02	UTDFN-1.5×2-6L	-40°C to +85°C	SGM41100W-443O02YUDT6G/TR	GGH XXX	Tape and Reel, 3000
SGM41100W-443O04	UTDFN-1.5×2-6L	-40°C to +85°C	SGM41100W-443O04YUDT6G/TR	GGI XXX	Tape and Reel, 3000
SGM41100W-443P01	UTDFN-1.5×2-6L	-40°C to +85°C	SGM41100W-443P01YUDT6G/TR	GGJ XXX	Tape and Reel, 3000
SGM41100W-443P02	UTDFN-1.5×2-6L	-40°C to +85°C	SGM41100W-443P02YUDT6G/TR	GGK XXX	Tape and Reel, 3000
SGM41100W-443P04	UTDFN-1.5×2-6L	-40°C to +85°C	SGM41100W-443P04YUDT6G/TR	GGL XXX	Tape and Reel, 3000
SGM41100W-445M01	UTDFN-1.5×2-6L	-40°C to +85°C	SGM41100W-445M01YUDT6G/TR	GGM XXX	Tape and Reel, 3000
SGM41100W-445M02	UTDFN-1.5×2-6L	-40°C to +85°C	SGM41100W-445M02YUDT6G/TR	GGN XXX	Tape and Reel, 3000
SGM41100W-445M04	UTDFN-1.5×2-6L	-40°C to +85°C	SGM41100W-445M04YUDT6G/TR	GGP XXX	Tape and Reel, 3000
SGM41100W-445N01	UTDFN-1.5×2-6L	-40°C to +85°C	SGM41100W-445N01YUDT6G/TR	GGQ XXX	Tape and Reel, 3000
SGM41100W-445N02	UTDFN-1.5×2-6L	-40°C to +85°C	SGM41100W-445N02YUDT6G/TR	GGR XXX	Tape and Reel, 3000
SGM41100W-445N04	UTDFN-1.5×2-6L	-40°C to +85°C	SGM41100W-445N04YUDT6G/TR	GGS XXX	Tape and Reel, 3000
SGM41100W-445O01	UTDFN-1.5×2-6L	-40°C to +85°C	SGM41100W-445O01YUDT6G/TR	GGT XXX	Tape and Reel, 3000
SGM41100W-445O02	UTDFN-1.5×2-6L	-40°C to +85°C	SGM41100W-445O02YUDT6G/TR	GGU XXX	Tape and Reel, 3000
SGM41100W-445O04	UTDFN-1.5×2-6L	-40°C to +85°C	SGM41100W-445O04YUDT6G/TR	OUF XXX	Tape and Reel, 3000
SGM41100W-445P01	UTDFN-1.5×2-6L	-40°C to +85°C	SGM41100W-445P01YUDT6G/TR	GGV XXX	Tape and Reel, 3000
SGM41100W-445P02	UTDFN-1.5×2-6L	-40°C to +85°C	SGM41100W-445P02YUDT6G/TR	GGW XXX	Tape and Reel, 3000
SGM41100W-445P04	UTDFN-1.5×2-6L	-40°C to +85°C	SGM41100W-445P04YUDT6G/TR	OV0 XXX	Tape and Reel, 3000
SGM41100W-448M01	UTDFN-1.5×2-6L	-40°C to +85°C	SGM41100W-448M01YUDT6G/TR	GGX XXX	Tape and Reel, 3000
SGM41100W-448M02	UTDFN-1.5×2-6L	-40°C to +85°C	SGM41100W-448M02YUDT6G/TR	GGY XXX	Tape and Reel, 3000

SGM41100W

True Monolithic Li-Ion/Polymer Battery Protector in Tiny Thin Package

MODEL	PACKAGE DESCRIPTION	SPECIFIED TEMPERATURE RANGE	ORDERING NUMBER	PACKAGE MARKING	PACKING OPTION
SGM41100W-448M04	UTDFN-1.5×2-6L	-40°C to +85°C	SGM41100W-448M04YUDT6G/TR	GGZ XXX	Tape and Reel, 3000
SGM41100W-448N01	UTDFN-1.5×2-6L	-40°C to +85°C	SGM41100W-448N01YUDT6G/TR	GH3 XXX	Tape and Reel, 3000
SGM41100W-448N02	UTDFN-1.5×2-6L	-40°C to +85°C	SGM41100W-448N02YUDT6G/TR	GH7 XXX	Tape and Reel, 3000
SGM41100W-448N04	UTDFN-1.5×2-6L	-40°C to +85°C	SGM41100W-448N04YUDT6G/TR	GHA XXX	Tape and Reel, 3000
SGM41100W-448O01	UTDFN-1.5×2-6L	-40°C to +85°C	SGM41100W-448O01YUDT6G/TR	GHD XXX	Tape and Reel, 3000
SGM41100W-448O02	UTDFN-1.5×2-6L	-40°C to +85°C	SGM41100W-448O02YUDT6G/TR	GHG XXX	Tape and Reel, 3000
SGM41100W-448O04	UTDFN-1.5×2-6L	-40°C to +85°C	SGM41100W-448O04YUDT6G/TR	GHH XXX	Tape and Reel, 3000
SGM41100W-448P01	UTDFN-1.5×2-6L	-40°C to +85°C	SGM41100W-448P01YUDT6G/TR	GHI XXX	Tape and Reel, 3000
SGM41100W-448P02	UTDFN-1.5×2-6L	-40°C to +85°C	SGM41100W-448P02YUDT6G/TR	GHJ XXX	Tape and Reel, 3000
SGM41100W-448P04	UTDFN-1.5×2-6L	-40°C to +85°C	SGM41100W-448P04YUDT6G/TR	GHK XXX	Tape and Reel, 3000
SGM41100W-450M01	UTDFN-1.5×2-6L	-40°C to +85°C	SGM41100W-450M01YUDT6G/TR	GHL XXX	Tape and Reel, 3000
SGM41100W-450M02	UTDFN-1.5×2-6L	-40°C to +85°C	SGM41100W-450M02YUDT6G/TR	GHM XXX	Tape and Reel, 3000
SGM41100W-450M04	UTDFN-1.5×2-6L	-40°C to +85°C	SGM41100W-450M04YUDT6G/TR	GHN XXX	Tape and Reel, 3000
SGM41100W-450N01	UTDFN-1.5×2-6L	-40°C to +85°C	SGM41100W-450N01YUDT6G/TR	GHP XXX	Tape and Reel, 3000
SGM41100W-450N02	UTDFN-1.5×2-6L	-40°C to +85°C	SGM41100W-450N02YUDT6G/TR	GHQ XXX	Tape and Reel, 3000
SGM41100W-450N04	UTDFN-1.5×2-6L	-40°C to +85°C	SGM41100W-450N04YUDT6G/TR	GHR XXX	Tape and Reel, 3000
SGM41100W-450O01	UTDFN-1.5×2-6L	-40°C to +85°C	SGM41100W-450O01YUDT6G/TR	GHS XXX	Tape and Reel, 3000
SGM41100W-450O02	UTDFN-1.5×2-6L	-40°C to +85°C	SGM41100W-450O02YUDT6G/TR	GHT XXX	Tape and Reel, 3000
SGM41100W-450O04	UTDFN-1.5×2-6L	-40°C to +85°C	SGM41100W-450O04YUDT6G/TR	GHU XXX	Tape and Reel, 3000
SGM41100W-450P01	UTDFN-1.5×2-6L	-40°C to +85°C	SGM41100W-450P01YUDT6G/TR	GHV XXX	Tape and Reel, 3000
SGM41100W-450P02	UTDFN-1.5×2-6L	-40°C to +85°C	SGM41100W-450P02YUDT6G/TR	GHW XXX	Tape and Reel, 3000
SGM41100W-450P04	UTDFN-1.5×2-6L	-40°C to +85°C	SGM41100W-450P04YUDT6G/TR	GHX XXX	Tape and Reel, 3000
SGM41100W-453M01	UTDFN-1.5×2-6L	-40°C to +85°C	SGM41100W-453M01YUDT6G/TR	GHY XXX	Tape and Reel, 3000
SGM41100W-453M02	UTDFN-1.5×2-6L	-40°C to +85°C	SGM41100W-453M02YUDT6G/TR	GHZ XXX	Tape and Reel, 3000
SGM41100W-453M04	UTDFN-1.5×2-6L	-40°C to +85°C	SGM41100W-453M04YUDT6G/TR	GI4 XXX	Tape and Reel, 3000
SGM41100W-453N01	UTDFN-1.5×2-6L	-40°C to +85°C	SGM41100W-453N01YUDT6G/TR	GI5 XXX	Tape and Reel, 3000
SGM41100W-453N02	UTDFN-1.5×2-6L	-40°C to +85°C	SGM41100W-453N02YUDT6G/TR	GI6 XXX	Tape and Reel, 3000

SGM41100W

True Monolithic Li-Ion/Polymer Battery Protector in Tiny Thin Package

MODEL	PACKAGE DESCRIPTION	SPECIFIED TEMPERATURE RANGE	ORDERING NUMBER	PACKAGE MARKING	PACKING OPTION
SGM41100W-453N04	UTDFN-1.5×2-6L	-40°C to +85°C	SGM41100W-453N04YUDT6G/TR	GI7 XXX	Tape and Reel, 3000
SGM41100W-453O01	UTDFN-1.5×2-6L	-40°C to +85°C	SGM41100W-453O01YUDT6G/TR	GI9 XXX	Tape and Reel, 3000
SGM41100W-453O02	UTDFN-1.5×2-6L	-40°C to +85°C	SGM41100W-453O02YUDT6G/TR	GIF XXX	Tape and Reel, 3000
SGM41100W-453O04	UTDFN-1.5×2-6L	-40°C to +85°C	SGM41100W-453O04YUDT6G/TR	GIG XXX	Tape and Reel, 3000
SGM41100W-453P01	UTDFN-1.5×2-6L	-40°C to +85°C	SGM41100W-453P01YUDT6G/TR	GIH XXX	Tape and Reel, 3000
SGM41100W-453P02	UTDFN-1.5×2-6L	-40°C to +85°C	SGM41100W-453P02YUDT6G/TR	GII XXX	Tape and Reel, 3000
SGM41100W-453P04	UTDFN-1.5×2-6L	-40°C to +85°C	SGM41100W-453P04YUDT6G/TR	GIJ XXX	Tape and Reel, 3000
SGM41100W-455M01	UTDFN-1.5×2-6L	-40°C to +85°C	SGM41100W-455M01YUDT6G/TR	GIK XXX	Tape and Reel, 3000
SGM41100W-455M02	UTDFN-1.5×2-6L	-40°C to +85°C	SGM41100W-455M02YUDT6G/TR	GIL XXX	Tape and Reel, 3000
SGM41100W-455M04	UTDFN-1.5×2-6L	-40°C to +85°C	SGM41100W-455M04YUDT6G/TR	GIM XXX	Tape and Reel, 3000
SGM41100W-455N01	UTDFN-1.5×2-6L	-40°C to +85°C	SGM41100W-455N01YUDT6G/TR	GIN XXX	Tape and Reel, 3000
SGM41100W-455N02	UTDFN-1.5×2-6L	-40°C to +85°C	SGM41100W-455N02YUDT6G/TR	GIP XXX	Tape and Reel, 3000
SGM41100W-455N04	UTDFN-1.5×2-6L	-40°C to +85°C	SGM41100W-455N04YUDT6G/TR	GIQ XXX	Tape and Reel, 3000
SGM41100W-455O01	UTDFN-1.5×2-6L	-40°C to +85°C	SGM41100W-455O01YUDT6G/TR	GIR XXX	Tape and Reel, 3000
SGM41100W-455O02	UTDFN-1.5×2-6L	-40°C to +85°C	SGM41100W-455O02YUDT6G/TR	GIS XXX	Tape and Reel, 3000
SGM41100W-455O04	UTDFN-1.5×2-6L	-40°C to +85°C	SGM41100W-455O04YUDT6G/TR	GIT XXX	Tape and Reel, 3000
SGM41100W-455P01	UTDFN-1.5×2-6L	-40°C to +85°C	SGM41100W-455P01YUDT6G/TR	GIU XXX	Tape and Reel, 3000
SGM41100W-455P02	UTDFN-1.5×2-6L	-40°C to +85°C	SGM41100W-455P02YUDT6G/TR	GIV XXX	Tape and Reel, 3000
SGM41100W-455P04	UTDFN-1.5×2-6L	-40°C to +85°C	SGM41100W-455P04YUDT6G/TR	GIW XXX	Tape and Reel, 3000
SGM41100W-458M01	UTDFN-1.5×2-6L	-40°C to +85°C	SGM41100W-458M01YUDT6G/TR	GIX XXX	Tape and Reel, 3000
SGM41100W-458M02	UTDFN-1.5×2-6L	-40°C to +85°C	SGM41100W-458M02YUDT6G/TR	GIY XXX	Tape and Reel, 3000
SGM41100W-458M04	UTDFN-1.5×2-6L	-40°C to +85°C	SGM41100W-458M04YUDT6G/TR	GIZ XXX	Tape and Reel, 3000
SGM41100W-458N01	UTDFN-1.5×2-6L	-40°C to +85°C	SGM41100W-458N01YUDT6G/TR	GJ6 XXX	Tape and Reel, 3000
SGM41100W-458N02	UTDFN-1.5×2-6L	-40°C to +85°C	SGM41100W-458N02YUDT6G/TR	GJB XXX	Tape and Reel, 3000
SGM41100W-458N04	UTDFN-1.5×2-6L	-40°C to +85°C	SGM41100W-458N04YUDT6G/TR	GJG XXX	Tape and Reel, 3000
SGM41100W-458O01	UTDFN-1.5×2-6L	-40°C to +85°C	SGM41100W-458O01YUDT6G/TR	GJH XXX	Tape and Reel, 3000
SGM41100W-458O02	UTDFN-1.5×2-6L	-40°C to +85°C	SGM41100W-458O02YUDT6G/TR	GJI XXX	Tape and Reel, 3000

SGM41100W

True Monolithic Li-Ion/Polymer Battery Protector in Tiny Thin Package

MODEL	PACKAGE DESCRIPTION	SPECIFIED TEMPERATURE RANGE	ORDERING NUMBER	PACKAGE MARKING	PACKING OPTION
SGM41100W-458O04	UTDFN-1.5×2-6L	-40°C to +85°C	SGM41100W-458O04YUDT6G/TR	GJJ XXX	Tape and Reel, 3000
SGM41100W-458P01	UTDFN-1.5×2-6L	-40°C to +85°C	SGM41100W-458P01YUDT6G/TR	GJK XXX	Tape and Reel, 3000
SGM41100W-458P02	UTDFN-1.5×2-6L	-40°C to +85°C	SGM41100W-458P02YUDT6G/TR	GJL XXX	Tape and Reel, 3000
SGM41100W-458P04	UTDFN-1.5×2-6L	-40°C to +85°C	SGM41100W-458P04YUDT6G/TR	GJM XXX	Tape and Reel, 3000

MARKING INFORMATION

NOTE: XXX = Date Code and Trace Code.

Y Y Y — Serial Number

X X X

Trace Code

Date Code - Year

Green (RoHS & HSF): SG Micro Corp defines "Green" to mean Pb-Free (RoHS compatible) and free of halogen substances. If you have additional comments or questions, please contact your SGMICRO representative directly.

DEVICE DESCRIPTION

Model : SGM41100W-AAABCC

Over-Voltage Threshold Options								
Option Code "AAA"	420	423	425	428	430	433	435	438
Over-Voltage Threshold V_{OV} (V)	4.20	4.225	4.25	4.275	4.30	4.325	4.35	4.375
Option Code "AAA"	440	443	445	448	450	453	455	458
Over-Voltage Threshold V_{OV} (V)	4.40	4.425	4.45	4.475	4.50	4.525	4.55	4.575
Under-Voltage Threshold Options								
Option Code "B"	M		N		O		P	
Under-Voltage Threshold V_{UV} (V)	2.6		2.7		2.8		3.0	
Current Threshold Combination Options								
Option Code "CC"	01			02			04	
Charge Over-Current I_{OC} (A)	0.156			0.19			0.35	
Discharge Over-Current I_{OD} (A)	0.169			0.30			0.56	
Short-Circuit Current (A)	4 × 0.169			4 × 0.30			4 × 0.56	

ABSOLUTE MAXIMUM RATINGS

Pack P to Pack N, 13V ⁽¹⁾ , 10mA Clamping ⁽²⁾	5s
Pack P to Pack N.....	-4.5V or +9V ⁽³⁾ , Continuous
Pack P to BATN.....	-4.5V ⁽³⁾ or +5.5V
Pack P to Pack N Short-Circuit ⁽⁴⁾	Continuous
Pack P to Pack N Attachment Inrush/Outrush ⁽⁵⁾	+9V/-4.5V
Pack P to BATN Attachment Inrush/Outrush ⁽⁶⁾	±4.5V
Surge Current ⁽⁷⁾	±20A
Junction Temperature.....	+150°C
Storage Temperature Range.....	-65°C to +150°C
Lead Temperature (Soldering, 10s).....	+260°C
ESD Susceptibility	
HBM.....	4000V
CDM.....	1000V

NOTES:

1. Evaluation at V_{BAT} = 4.5V.
2. The clamping may reach 10mA at an input voltage > 13V.
3. Test with a voltage regulated supply that has 2A current limit and increase the voltage progressively for less than 1V/ms slope rate. Apply a voltage to the device under test from 0V to given voltages.
4. The device is tested after being installed on the circuit board in Figure 1. Clip a 4.5V 5A power source onto the P and M to simulate a battery and short the Pack P and the Pack N with an 80mΩ wire.
5. The device is tested after being installed on the circuit board in Figure 1. Connect a 3.2V supply and 2A sinking resistor R_{SINK} as showed in Figure 2 to the P and M for inrush test. Clip a 4.5V 5A supply for outrush test.
6. The device is tested after being installed on the circuit board in Figure 1 with the circuit in Figure 3.
7. Parallel or connect in reverse polarity two battery packs of Figure 1. Limit the battery pack impedance to limit the surge current to 20A.

RECOMMENDED OPERATING CONDITIONS

Supply Voltage Range.....	0V to 5.5V
Battery Voltage Range.....	0 to 4.5V
Junction Temperature Range.....	-40°C to +85°C

OVERSTRESS CAUTION

Stresses beyond those listed in Absolute Maximum Ratings may cause permanent damage to the device. Exposure to absolute maximum rating conditions for extended periods may affect reliability. Functional operation of the device at any conditions beyond those indicated in the Recommended Operating Conditions section is not implied.

ESD SENSITIVITY CAUTION

This integrated circuit can be damaged if ESD protections are not considered carefully. SGMICRO recommends that all integrated circuits be handled with appropriate precautions. Failure to observe proper handling and installation procedures can cause damage. ESD damage can range from subtle performance degradation to complete device failure. Precision integrated circuits may be more susceptible to damage because even small parametric changes could cause the device not to meet the published specifications.

DISCLAIMER

SG Micro Corp reserves the right to make any change in circuit design, or specifications without prior notice.

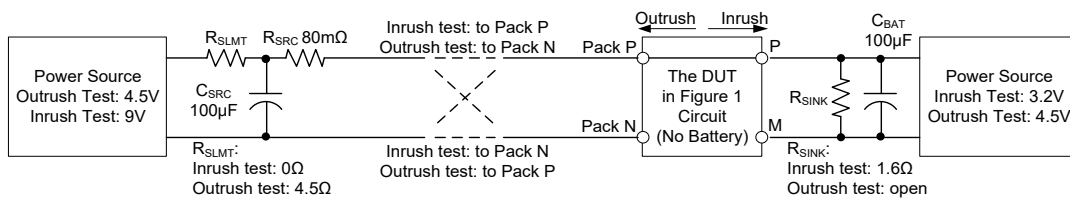

Figure 2. Test Set-Up for Pack P to Pack N Attachment Inrush/Outrush

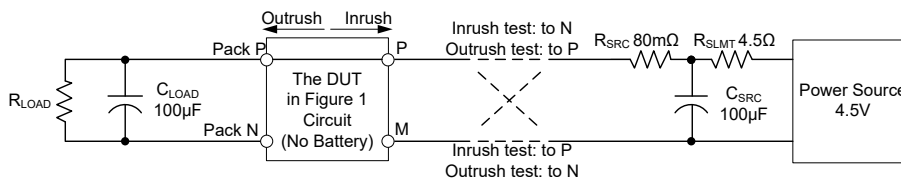
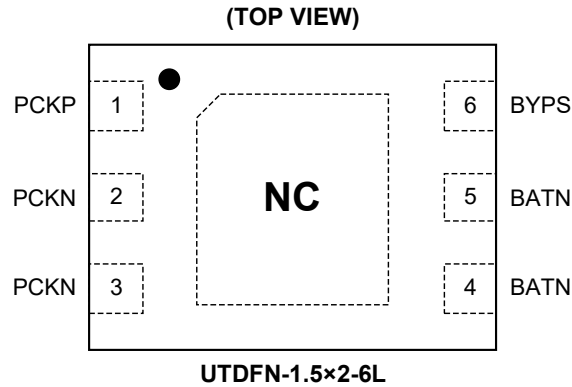

Figure 3. Test Set-Up for Pack P to BATN Attachment Inrush/Outrush

PIN CONFIGURATION



PIN DESCRIPTION

PIN	NAME	TYPE	FUNCTION
1	PCKP	P	Internal Connection. No external connection.
2, 3	PCKN	P	Power Input and Output, the Battery Pack Cathode. Short this pin to BATN pin to release off the locked-open state, and make the output path closed.
4, 5	BATN	G	Ground of Internal Circuit. Connect to the battery cathode end.
6	BYPS	P	Power Supply Pin and Disconnection Locked-Off Triggering Input. Place a 1μF capacitor between this pin and BATN pin, and place a 1kΩ resistor between the pin and the positive connection of the battery pack. Shorting this pin to PCKN pin momentarily places the circuit into locked-open state.
Exposed Pad	NC	NC	Not Connected Internally. Connect to BATN pin externally is recommended.

NOTE: G = Ground, P = Power for the Circuit, NC = Not Connected.

ELECTRICAL CHARACTERISTICS

(T_J = +25°C, I_{CHG} = I_{DIS} = 200mA, V_{BAT} = 3.7V, unless otherwise noted.)

PARAMETER	SYMBOL	CONDITIONS	MIN	TYP	MAX	UNITS
Charge Over-Voltage Threshold	V _{OV}	SGM41100W-420_ _ _	T _J = +25°C	4.180	4.200	4.220
			T _J = -20°C to +55°C	4.165		4.235
			T _J = -40°C to +85°C	4.145		4.255
		SGM41100W-423_ _ _	T _J = +25°C	4.205	4.225	4.245
			T _J = -20°C to +55°C	4.190		4.260
			T _J = -40°C to +85°C	4.170		4.280
		SGM41100W425_ _ _	T _J = +25°C	4.230	4.250	4.270
			T _J = -20°C to +55°C	4.215		4.285
			T _J = -40°C to +85°C	4.195		4.305
		SGM41100W-428_ _ _	T _J = +25°C	4.255	4.275	4.295
			T _J = -20°C to +55°C	4.240		4.310
			T _J = -40°C to +85°C	4.220		4.330
		SGM41100W-430_ _ _	T _J = +25°C	4.280	4.300	4.320
			T _J = -20°C to +55°C	4.265		4.335
			T _J = -40°C to +85°C	4.245		4.355
		SGM41100W-433_ _ _	T _J = +25°C	4.305	4.325	4.345
			T _J = -20°C to +55°C	4.290		4.360
			T _J = -40°C to +85°C	4.270		4.380
		SGM41100W-435_ _ _	T _J = +25°C	4.330	4.350	4.370
			T _J = -20°C to +55°C	4.315		4.385
			T _J = -40°C to +85°C	4.295		4.405
		SGM41100W-438_ _ _	T _J = +25°C	4.355	4.375	4.395
			T _J = -20°C to +55°C	4.340		4.410
			T _J = -40°C to +85°C	4.320		4.430
		SGM41100W-440_ _ _	T _J = +25°C	4.380	4.400	4.420
			T _J = -20°C to +55°C	4.365		4.435
			T _J = -40°C to +85°C	4.345		4.455
		SGM41100W-443_ _ _	T _J = +25°C	4.405	4.425	4.445
			T _J = -20°C to +55°C	4.390		4.460
			T _J = -40°C to +85°C	4.370		4.480
		SGM41100W-445_ _ _	T _J = +25°C	4.430	4.450	4.470
			T _J = -20°C to +55°C	4.415		4.485
			T _J = -40°C to +85°C	4.395		4.505
		SGM41100W-448_ _ _	T _J = +25°C	4.455	4.475	4.495
			T _J = -20°C to +55°C	4.440		4.510
			T _J = -40°C to +85°C	4.420		4.530
		SGM41100W-450_ _ _	T _J = +25°C	4.480	4.500	4.520
			T _J = -20°C to +55°C	4.465		4.535
			T _J = -40°C to +85°C	4.445		4.555

ELECTRICAL CHARACTERISTICS (continued)

(T_J = +25°C, I_{CHG} = I_{DIS} = 200mA, V_{BAT} = 3.7V, unless otherwise noted.)

PARAMETER	SYMBOL	CONDITIONS		MIN	TYP	MAX	UNITS
Charge Over-Voltage Threshold	V _{OV}	SGM41100W-453_ _ _	T _J = +25°C	4.505	4.525	4.545	V
			T _J = -20°C to +55°C	4.490		4.560	
			T _J = -40°C to +85°C	4.470		4.580	
		SGM41100W-455_ _ _	T _J = +25°C	4.530	4.550	4.570	
			T _J = -20°C to +55°C	4.515		4.585	
			T _J = -40°C to +85°C	4.495		4.605	
		SGM41100W-458_ _ _	T _J = +25°C	4.555	4.575	4.595	
			T _J = -20°C to +55°C	4.540		4.610	
			T _J = -40°C to +85°C	4.520		4.630	
OV Release Hysteresis	V _{OVHYS}	Charger voltage lower than battery voltage	T _J = +25°C	100	150	200	mV
			T _J = -40°C to +85°C	95		205	
Battery Under-Voltage Threshold ⁽¹⁾	V _{UV}	SGM41100W- _ _ _ M _ _	T _J = +25°C	2.545	2.600	2.655	V
			T _J = -40°C to +85°C	2.515		2.685	
		SGM41100W- _ _ _ N _ _	T _J = +25°C	2.645	2.700	2.755	
			T _J = -40°C to +85°C	2.615		2.785	
		SGM41100W- _ _ _ O _ _	T _J = +25°C	2.745	2.800	2.855	
			T _J = -40°C to +85°C	2.715		2.885	
		SGM41100W- _ _ _ P _ _	T _J = +25°C	2.945	3.000	3.055	
			T _J = -40°C to +85°C	2.915		3.085	
UV Release Hysteresis	V _{UVHYS}	When a charging supply is applied	T _J = +25°C	75	100	125	mV
			T _J = -40°C to +85°C	70		130	
Shutdown Voltage	V _{SHDN}	T _J = +25°C	1.35	1.5	1.65	V	
		T _J = -40°C to +85°C	1.1		1.9		
Charging Prohibition Voltage ⁽¹⁾	V _{NOCHG}	T _J = +25°C	1.5	1.6	1.7	V	
		T _J = -40°C to +85°C	1.4		1.8		
Discharge Over-Current	I _{OD}	SGM41100W- _ _ _ _ 01	T _J = +25°C	0.140	0.169	0.200	A
			T _J = -40°C to +85°C	0.105		0.235	
		SGM41100W- _ _ _ _ 02	T _J = +25°C	0.270	0.300	0.330	
			T _J = -40°C to +85°C	0.225		0.375	
		SGM41100W- _ _ _ _ 04	T _J = +25°C	0.500	0.560	0.620	
			T _J = -40°C to +85°C	0.435		0.685	
Charge Over-Current	I _{OC}	SGM41100W- _ _ _ _ 01	T _J = +25°C	0.130	0.156	0.200	A
			T _J = -40°C to +85°C	0.100		0.225	
		SGM41100W- _ _ _ _ 02	T _J = +25°C	0.165	0.190	0.215	
			T _J = -40°C to +85°C	0.120		0.260	
		SGM41100W- _ _ _ _ 04	T _J = +25°C	0.310	0.350	0.390	
			T _J = -40°C to +85°C	0.250		0.450	

ELECTRICAL CHARACTERISTICS (continued)(T_J = +25°C, I_{CHG} = I_{DIS} = 200mA, V_{BAT} = 3.7V, unless otherwise noted.)

PARAMETER	SYMBOL	CONDITIONS	MIN	TYP	MAX	UNITS
Pass Resistance	R _P	T _J = +25°C		42	52	mΩ
		T _J = -40°C to +85°C			62	
Operating Current	I _{OP}	T _J = +25°C		1.1	1.5	μA
		T _J = -40°C to +85°C			2.0	
Shutdown Current	I _{SHDN}	The stable current flowing into the device when it is in any of following shutdown conditions that the battery voltage is lower than V _{UV} (then V _{SHDN} , V _{NOCHG} if the battery voltage further drops), the device is set into latched-off	T _J = +25°C		0.05	μA
			T _J = -40°C to +85°C		0.30	
Over-Voltage Detection Delay ⁽²⁾	t _{OVPD}	T _J = +25°C	923	1066	1209	ms
		T _J = -40°C to +85°C	537		1342	
Under-Voltage Detection Delay ⁽²⁾	t _{UVPD}	T _J = +25°C	115	144	188	ms
		T _J = -40°C to +85°C	67		208	
Discharge Over-Current Detection Delay ⁽²⁾	t _{ODD}	T _J = +25°C	57	80	113	ms
		T _J = -40°C to +85°C	33		125	
Discharge Over-Current Retry Time ⁽²⁾	t _{RETRY}	T _J = +25°C	461	528	609	ms
		T _J = -40°C to +85°C	268		676	
Charge Over-Current Detection Delay ⁽²⁾	t _{OCD}	T _J = +25°C	57	80	113	ms
		T _J = -40°C to +85°C	33		125	
Discharge Short-Circuit Detection Delay	t _{OCSD}	T _J = +25°C	0.196	0.3	0.5	ms
		T _J = -40°C to +85°C	0.14		0.7	
Discharge Short-Circuit Current	I _{SC}			4 × I _{OP}		A

NOTES:

- V_{UV} and V_{SHDN} variation seat in the same side deviation and no range overlaps.
- The TYP value and MAX value are combination of the detection delay time and a possible polling period of about 32ms, while the MIN value represents the minimum detection delay with portion of a polling period added, as the pass path cutting action is synchronized to the internal polling.

TYPICAL PERFORMANCE CHARACTERISTICS

$T_J = +25^\circ\text{C}$, $I_{\text{CHG}} = I_{\text{DIS}} = 50\text{mA}$, $V_{\text{BAT}} = 3.7\text{V}$, unless otherwise noted.

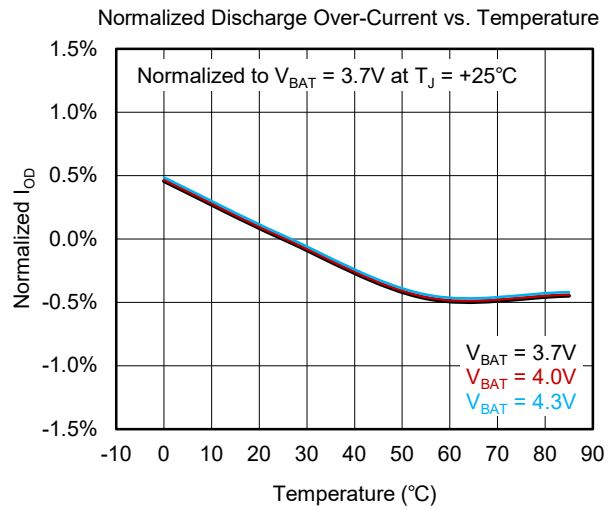
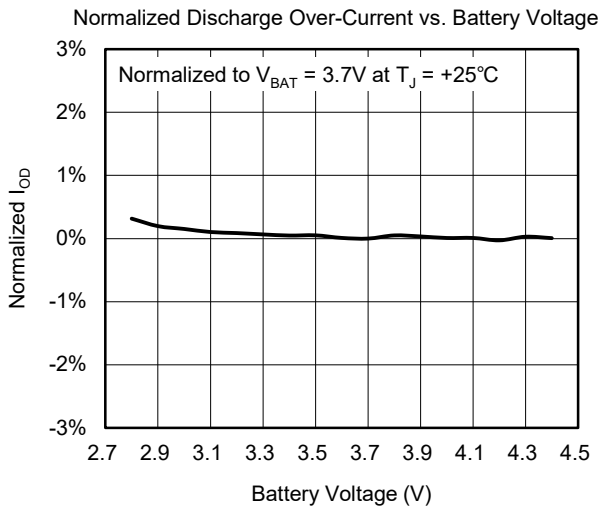
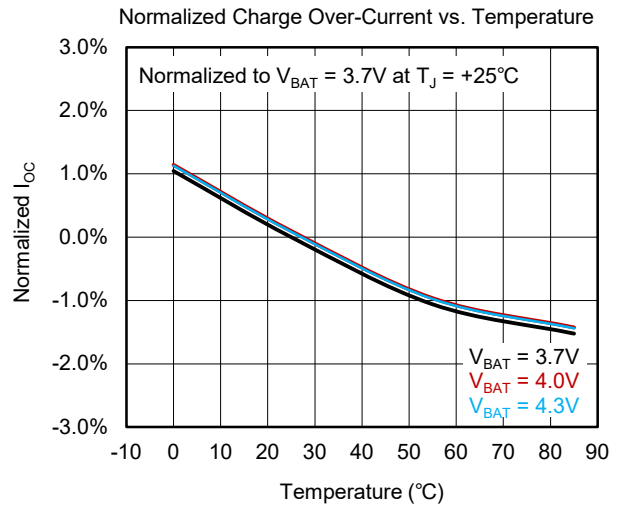
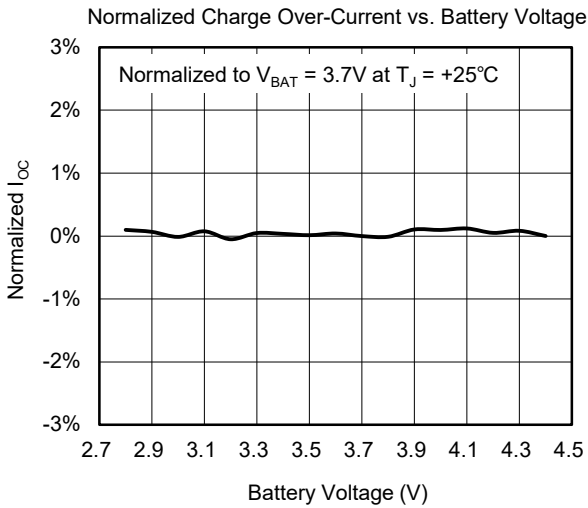
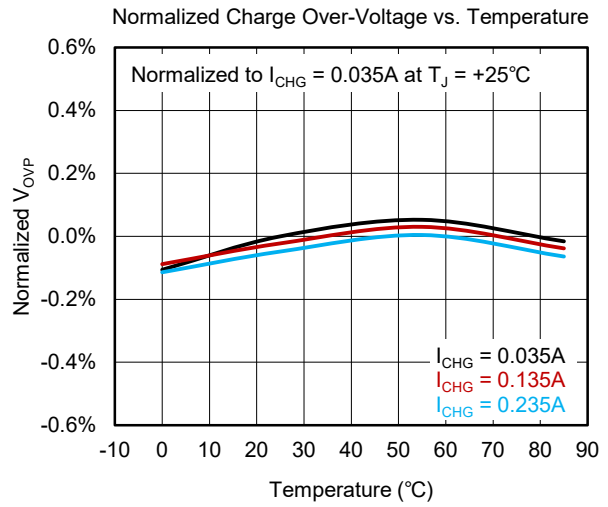
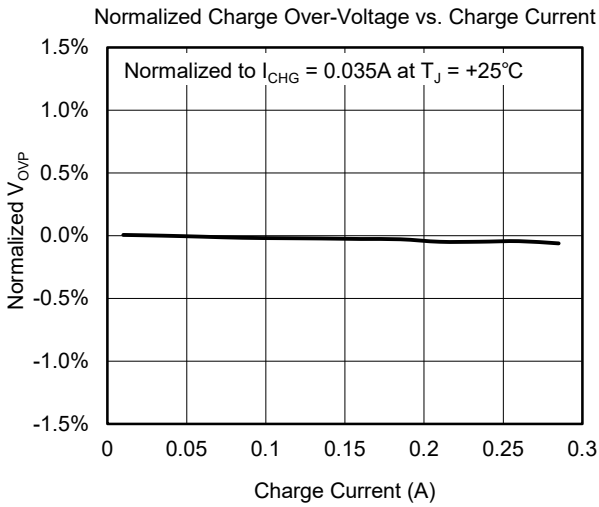

TYPICAL PERFORMANCE CHARACTERISTICS (continued)

$T_J = +25^\circ\text{C}$, $I_{\text{CHG}} = I_{\text{DIS}} = 50\text{mA}$, $V_{\text{BAT}} = 3.7\text{V}$, unless otherwise noted.

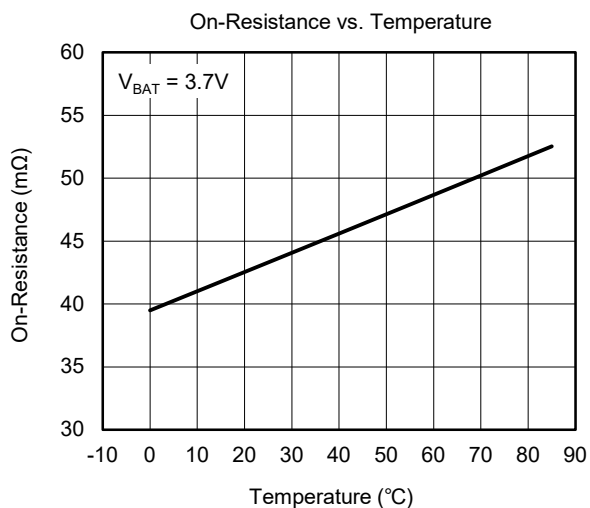
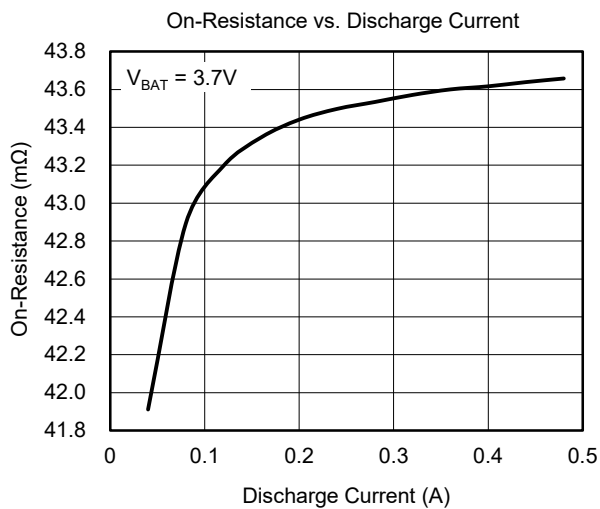
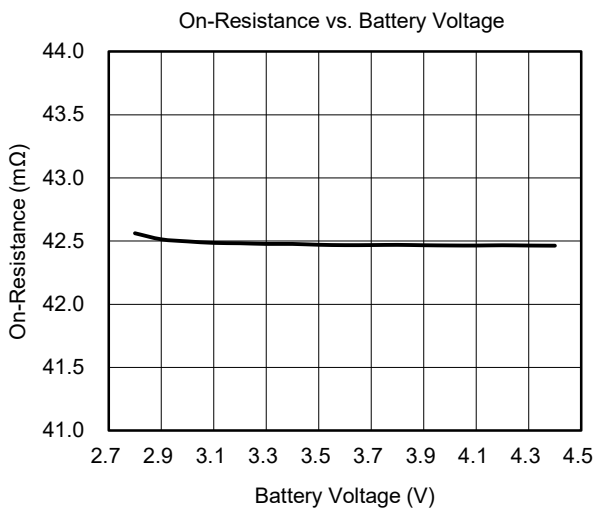

DETAILED DESCRIPTION

The SGM41100W monitors voltage and current applied on battery cell connected between PCKP and BATN, and opens the connection between battery and pack terminal with its internal switches when a fault condition is detected.

Voltage Related Protections

When battery voltage reaches over-voltage threshold (V_{OV}), the charge path is open-circuit. The path closes again when the charger voltage is lower than battery voltage and the battery voltage falls back about V_{OVHYS} below the over-voltage threshold (V_{OV}).

In order to protect the battery from discharge under-voltage status when battery voltage falls below V_{UV} for t_{UVPD} or V_{SHDN} instantly, the discharge path is open-circuit, the device enters into shutdown with only very low resistive leakage flowing into it, which helps to keep the battery from harmful exhausted condition as long as possible. The path closes again when a charging supply is applied and the battery voltage rises to about V_{UVHYS} above the V_{UV} threshold.

Charge an exhausted battery: While the battery is over-discharged the battery could be in the following states.

- Battery voltage below V_{NOCHG} : The charge path or discharge path is open correspondingly when the applied bias condition is settled.
- Battery voltage is in the range of V_{NOCHG} to V_{UV} (if there is such voltage gap): The path switch is on for 144ms (t_{UVPD}) in every 132ms and off for 2ms when charge current flows through the body diode. During this period, the charger will see the terminal voltage steps up/down.
- Battery voltage above under-voltage threshold: In this condition, the chip enters normal operation and charge and discharge modes are allowed.

When battery voltage is between V_{SHDN} and V_{NOCHG} , there is about 150 μ s circuit settle time when a pulse charge current may flow through.

When the battery voltage is in the range of 0.5V ~ 0.7V, and the external voltage applied on the device is also too low to start full operation, the charging current flows through the path switch's body diode.

Current Related Protections

When discharge over-current condition occurs and keeps for discharge over-current detection delay (t_{ODD}), the discharge path opens. The path closes again after t_{RETRY} for retrying. The SGM41100W keeps retrying until the over-current condition is released or the battery discharges to low when the SGM41100W turns into battery under-voltage protection state.

During a charging condition if a charge over-current is identified, the SGM41100W enters the locked-off state. This state can be reset by charger removal (pack removal).

Short-circuit protection: When discharge current exceeds the over-current threshold, discharge path disconnects instantly in t_{OCS} , in order to protect the battery from potential over-current stress. After this disconnection, the SGM41100W stays in the locked-off non-conducting state until being reactivated.

Burst load outrush: In many systems, overload conditions will occur momentarily. The device allows for this short duration discharge condition by allowing the discharge path to remain closed even after a discharge over-current is detected for duration of discharge over-current detection delay.

When a charge over-current condition is identified, and after charge over-current detection deglitch, the charge path is cut off. The device restores to the conducting state when the PCKP to PCKN voltage drops about 3mV lower than the battery voltage.

Parallel battery packs: When paralleling two battery packs utilizing SGM41100Ws, a momentary current surge may cause charge over-current protection in the pack with the lower voltage. The higher voltage pack could enter a discharge over-current protection. The charge over-current or discharge over-current protection resets only after the higher voltage battery pack discharges to a voltage slightly lower than the lower voltage pack. After this discharge, both packs will conduct.

DETAILED DESCRIPTION (continued)

It is highly recommended that the packs should be placed into a locked-open non-conducting state first (by connecting PCKP to PCKN momentarily) before being paralleled to avoid current overstress. When a charge supply is applied to the paralleled packs, the locked-open state will release.

Battery delivery state: It is recommended to deliver a battery pack in a locked-off non-conducting state to avoid unintentional shorting during production handling or transportation. The circuit of Figure 1 places the SGM41100W into a locked-off state after battery attachment by momentarily shorting BYPS and PCKN.

Pack activation: In order to release the pack from locked-off state and to place it into a conducting state, apply a charging input, or connect PCKN to BATN momentarily.

Caution: The battery short or load side terminal short outside the protection circuit's loop during battery attaching may cause excessive high surge current and excessive high current-breaking voltage surge, which may cause damage or degrade the life duration of battery and protection circuit. It is recorded that the accidental anode to ground plane shorting causes heavy surge, which can actually be avoided by leaving enough clearance around the anode pad on PCB or soldering/attaching the anode firstly in assembly (as the short between cathode to ground will not cause excessive surge).

Surge, ESD and Reversed Attachment

The SGM41100W absorbs voltage surge applied between PCKP and PCKN, by passing the surge current through its switch and the battery. Surge may occur when attaching the pack or battery cell.

The SGM41100W survives either if a cell is placed in reverse or a charge input is attached in reverse, but not both at the same time. Any of these reverse attachments, short circuits, inrush surges and outrush will cause overstress. Do not test those cases in normal production inspection, as this kind of test itself may cause performance degradation or even damage the device.

Caution about ESD damage to the battery: The battery pack might be the biggest element in equipment and induce much during an ESD event. Careful design

of guided discharge path is desired for the equipment case sealing air-gap discharge over the battery and those connect to the battery closely.

Caution on electrochemical corrosion: As a battery can apply potential over the electrodes continuously and cause electrochemical corrosion, the corrosion product may spread in the hollow beneath a surface mount device and cause leakage. Moisture-proof coating is recommended, especially when using compact devices.

Cautions for Evaluation Test

Some types of electronic load simulators may have excessive inrush current, and some BPM testers may have voltage transition surges, which may trigger the protection of the SGM41100W. Careful attention is required for doing such evaluations with these kinds of equipment. External voltage and current limits within the conditions specified in the Absolute Maximum Ratings section of this datasheet are required.

Select Protection Parameters

Battery models from different vendors may be customized for different applications. Consult the battery vendor for protection limits for specific battery model.

Parameters for the protection circuit and of the charger circuit affecting same variables should be set for proper charge or discharge protection sequence. For example, the over-voltage threshold of the battery should be 50mV ~ 100mV higher than constant voltage threshold of the charger.

Cautions on parameter misalignment: If the V_{OV} is lower than the full charge voltage of the battery charger, the protection circuit cuts off the battery charge path before the battery is fully charged, and turns into the non-conductive locked-off state; if the I_{OC} is lower than the charge current, the protection circuit also turns itself into the locked-off state. In either V_{OV} or I_{OC} , the charger input should be removed and then reapplied for activating the protection circuit from the locked-off state to the conducting state. If the charger is not removed after a V_{OV} or I_{OV} event, the battery will not be charged even if the battery voltage is depleted.

REVISION HISTORY

NOTE: Page numbers for previous revisions may differ from page numbers in the current version.

DECEMBER 2023 – REV.A to REV.A.1	Page
Updated Features section.....	1

Changes from Original (SEPTEMBER 2021) to REV.A	Page
Changed from product preview to production data.....	All

PACKAGE OUTLINE DIMENSIONS

UTDFN-1.5x2-6L

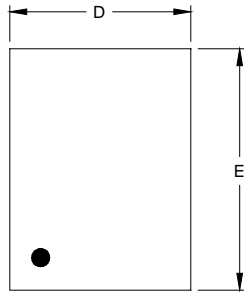

TOP VIEW

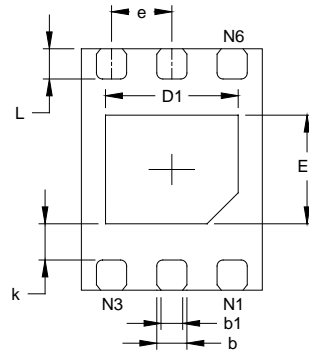

BOTTOM VIEW

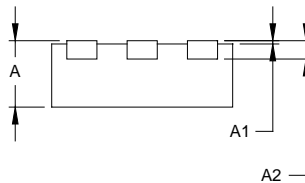

SIDE VIEW

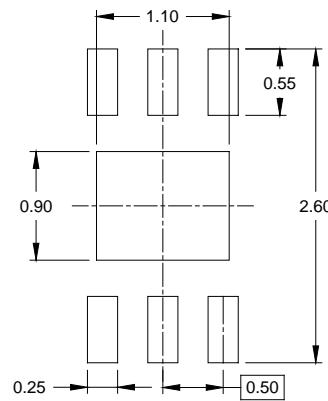

RECOMMENDED LAND PATTERN (Unit: mm)

Symbol	Dimensions In Millimeters		Dimensions In Inches	
	MIN	MAX	MIN	MAX
A	0.500	0.600	0.020	0.024
A1	0.000	0.050	0.000	0.002
A2	0.152 REF		0.006 REF	
D	1.400	1.600	0.055	0.063
D1	1.000	1.200	0.039	0.047
E	1.900	2.100	0.075	0.083
E1	0.800	1.000	0.031	0.039
k	0.300 REF		0.012 REF	
b	0.200	0.300	0.008	0.012
b1	0.180 REF		0.007 REF	
e	0.500 BSC		0.020 BSC	
L	0.200	0.300	0.008	0.012

NOTE: This drawing is subject to change without notice.

PACKAGE INFORMATION

TAPE AND REEL INFORMATION

REEL DIMENSIONS



TAPE DIMENSIONS



NOTE: The picture is only for reference. Please make the object as the standard.

KEY PARAMETER LIST OF TAPE AND REEL

Package Type	Reel Diameter	Reel Width W1 (mm)	A0 (mm)	B0 (mm)	K0 (mm)	P0 (mm)	P1 (mm)	P2 (mm)	W (mm)	Pin1 Quadrant
UTDFN-1.5×2-6L	7"	9.5	1.70	2.30	0.75	4.0	4.0	2.0	8.0	Q2

000001

PACKAGE INFORMATION

CARTON BOX DIMENSIONS



NOTE: The picture is only for reference. Please make the object as the standard.

KEY PARAMETER LIST OF CARTON BOX

Reel Type	Length (mm)	Width (mm)	Height (mm)	Pizza/Carton
7" (Option)	368	227	224	8
7"	442	410	224	18

DD0002